

Chip Beads

For power line

MPZ series

| | | |
|--------------|------------------|-------------------------|
| Type: | MPZ0603 | 0603[0201 inch]* |
| | MPZ1005 | 1005[0402 inch] |
| | MPZ1608 | 1608[0603 inch] |
| | MPZ2012 | 2012[0805 inch] |
| | MPZ1005-E | 1005[0402 inch] |

* Dimensions Code JIS[EIA]

Issue date: September 2012

- All specifications are subject to change without notice.
- Conformity to RoHS Directive: This means that, in conformity with EU Directive 2002/95/EC, lead, cadmium, mercury, hexavalent chromium, and specific bromine-based flame retardants, PBB and PBDE, have not been used, except for exempted applications.

Chip Beads

For Power Line

Conformity to RoHS Directive

MPZ Series MPZ0603

FEATURES

- This chip bead implements a 0603 shape in its capacity as an EMC countermeasure component, and it supports compact devices that need smaller spaces.
- This product can cope with a high current due to its low DC resistance. It is also most suitable for lower power consumption.
- Because of its low DC resistance, it is useful for audio lines.
- No cross talk with closed magnetic circuit structural design.
- It is a product conforming to RoHS directive.

APPLICATIONS

Removal of power line noises of cellular phones, PCs, note PCs, TV tuners, STBs, audio players, DVDs, DSCs, DVCs, game machines, digital photo frames, etc.

PRODUCT IDENTIFICATION

| | | | | | | |
|-----|------|-----|-----|-----|-----|-----|
| MPZ | 0603 | S | 220 | C | T | □□□ |
| (1) | (2) | (3) | (4) | (5) | (6) | (7) |

- (1) Series name
- (2) Dimensions L×W
- (3) Type name
- (4) Impedance
220: 22Ω at 100MHz
- (5) Characteristic type
- (6) Packaging style
T:Taping(reel)
- (7) TDK internal code

HANDLING AND PRECAUTIONS

- Before soldering, be sure to preheat components. The preheating temperature should be set so that the temperature difference between the solder temperature and product temperature does not exceed 150°C.
- After mounting components onto the printed circuit board, do not apply stress through board bending or mishandling.
- Do not expose the inductors to stray magnetic fields.
- Avoid static electricity discharge during handling.
- When hand soldering, apply the soldering iron to the printed circuit board only. Temperature of the iron tip should not exceed 350°C. Soldering time should not exceed 3 seconds.

SHAPES AND DIMENSIONS/RECOMMENDED PC BOARD PATTERN

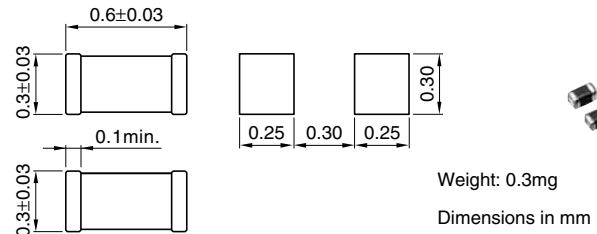

SPECIFICATIONS

| | |
|-----------------------------|----------------------------|
| Operating temperature range | -55 to +125°C |
| Storage temperature range | -55 to +125°C(After mount) |

PACKAGING STYLE AND QUANTITIES

| | |
|-----------------|-------------------|
| Packaging style | Quantity |
| Taping | 15000 pieces/reel |

RECOMMENDED SOLDERING CONDITION REFLOW SOLDERING

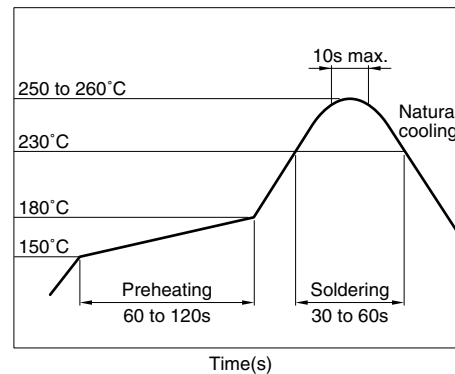

ELECTRICAL CHARACTERISTICS

| Part No. | Impedance (Ω)[100MHz]* | DC resistance (Ω)max. | Rated current (mA)max. |
|--------------|---------------------------|--------------------------|---------------------------|
| MPZ0603S220C | 22±25% | 0.065 | 1000 |
| MPZ0603S330C | 33±25% | 0.090 | 750 |
| MPZ0603S470C | 47±25% | 0.120 | 500 |

* Test equipment: E4991A or equivalent
Test tool: 16197 or equivalent
Test temperature: 25±10°C

• Conformity to RoHS Directive: This means that, in conformity with EU Directive 2002/95/EC, lead, cadmium, mercury, hexavalent chromium, and specific bromine-based flame retardants, PBB and PBDE, have not been used, except for exempted applications.

• Please contact our Sales office when your application is considered the following:
The device's failure or malfunction may directly endanger human life (e.g. application for automobile/aircraft/medical/nuclear power devices, etc.)

• All specifications are subject to change without notice.

TYPICAL ELECTRICAL CHARACTERISTICS Z FREQUENCY CHARACTERISTICS MPZ0603S SERIES

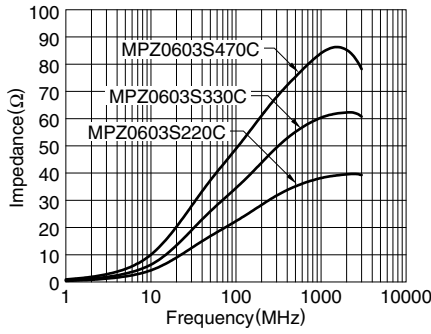

Z, X, R vs. FREQUENCY CHARACTERISTICS MPZ0603S220C



MPZ0603S330C

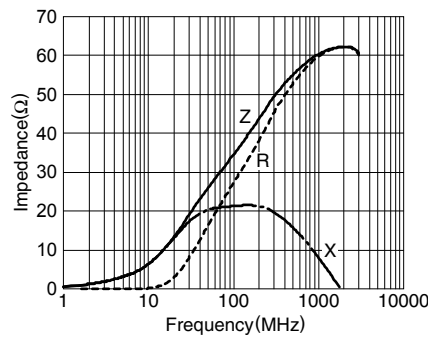

MPZ0603S470C

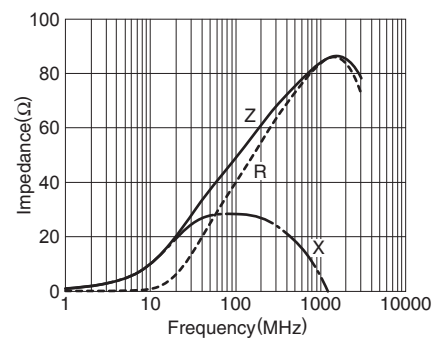

PACKAGING STYLES REEL DIMENSIONS

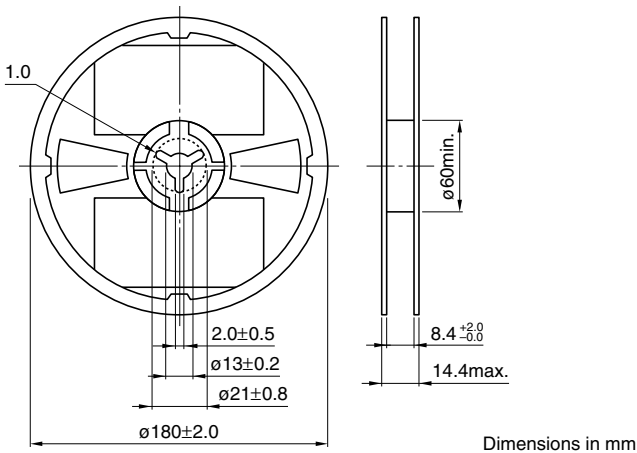

TAPE DIMENSIONS

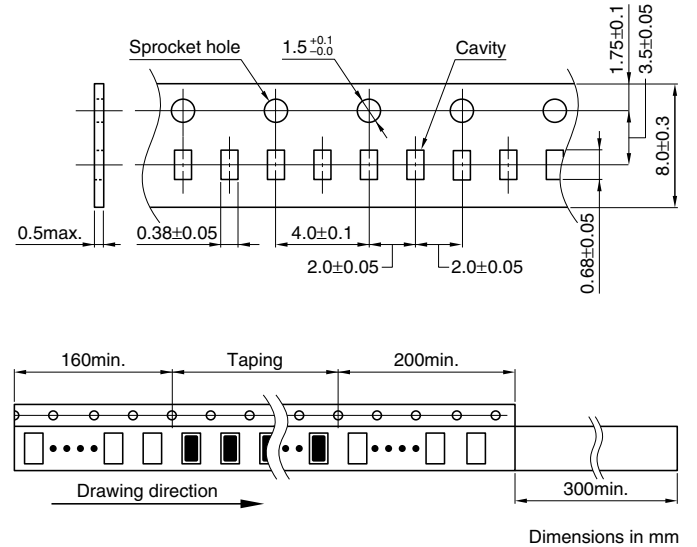

• All specifications are subject to change without notice.

Chip Beads

For Power Line

Conformity to RoHS Directive

MPZ Series MPZ1005

FEATURES

- TDK has manufactured MPZ1005 type as EMI countermeasure product for power line.
- This type is the best for energy-saving in the low DC resistance.
- No cross talk with closed magnetic circuit structural design.
- It is a product conforming to RoHS directive.

APPLICATIONS

Removal of power line noises of cellular phones, PCs, note PCs, TVs, TV tuners, STBs, audio players, DVDs, DSCs, DVCs, game machines, digital photo frames, car navigation system, PNDs, etc.

PRODUCT IDENTIFICATION

| | | | | | | | | |
|-----|------|-----|-----|-----|-----|--------------------------|--------------------------|--------------------------|
| MPZ | 1005 | S | 121 | C | T | <input type="checkbox"/> | <input type="checkbox"/> | <input type="checkbox"/> |
| (1) | (2) | (3) | (4) | (5) | (6) | (7) | | |

- (1) Series name
- (2) Dimensions L×W
- (3) Type name
- (4) Impedance
121: 120Ω at 100MHz
- (5) Characteristic type
- (6) Packaging style
T:Taping(reel)
- (7) TDK internal code

HANDLING AND PRECAUTIONS

- Before soldering, be sure to preheat components. The preheating temperature should be set so that the temperature difference between the solder temperature and product temperature does not exceed 150°C.
- After mounting components onto the printed circuit board, do not apply stress through board bending or mishandling.
- Do not expose the inductors to stray magnetic fields.
- Avoid static electricity discharge during handling.
- When hand soldering, apply the soldering iron to the printed circuit board only. Temperature of the iron tip should not exceed 350°C. Soldering time should not exceed 3 seconds.

SHAPES AND DIMENSIONS/RECOMMENDED PC BOARD PATTERN



SPECIFICATIONS

| | |
|-----------------------------|---------------------------|
| Operating temperature range | -40 to +85°C |
| Storage temperature range | -40 to +85°C(After mount) |

PACKAGING STYLE AND QUANTITIES

| | |
|-----------------|-------------------|
| Packaging style | Quantity |
| Taping | 10000 pieces/reel |

RECOMMENDED SOLDERING CONDITION

REFLOW SOLDERING

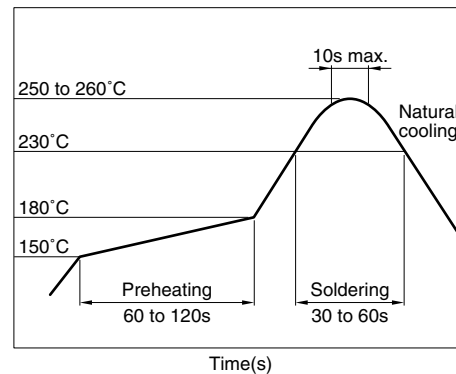

ELECTRICAL CHARACTERISTICS

| Part No. | Impedance (Ω)[100MHz]* | DC resistance (Ω)max. | Rated current (A)max. |
|--------------|---------------------------|--------------------------|--------------------------|
| MPZ1005S100C | 10±5Ω | 0.025 | 2.0 |
| MPZ1005S300C | 30±10Ω | 0.035 | 1.7 |
| MPZ1005S600C | 60±25% | 0.060 | 1.5 |
| MPZ1005S121C | 120±25% | 0.090 | 1.2 |
| MPZ1005Y900C | 90±25% | 0.100 | 1.2 |

* Test equipment: E4991A or equivalent
Test tool: 16192A or equivalent
Test temperature: 25±10°C

• Conformity to RoHS Directive: This means that, in conformity with EU Directive 2002/95/EC, lead, cadmium, mercury, hexavalent chromium, and specific bromine-based flame retardants, PBB and PBDE, have not been used, except for exempted applications.

• Please contact our Sales office when your application is considered the following:
The device's failure or malfunction may directly endanger human life (e.g. application for automobile/aircraft/medical/nuclear power devices, etc.)

• All specifications are subject to change without notice.

TYPICAL ELECTRICAL CHARACTERISTICS Z FREQUENCY CHARACTERISTICS MPZ1005S/MPZ1005Y SERIES



Z, X, R vs. FREQUENCY CHARACTERISTICS MPZ1005S100C



MPZ1005S300C



MPZ1005S600C

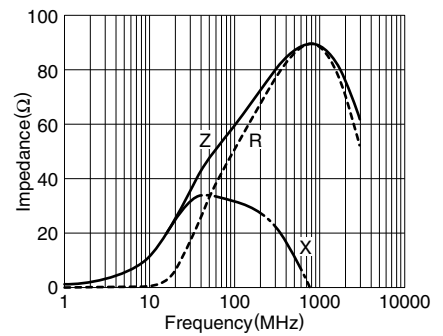

MPZ1005S121C



MPZ1005Y900C



PACKAGING STYLES REEL DIMENSIONS



TAPE DIMENSIONS



• All specifications are subject to change without notice.

Chip Beads

For Power Line

Conformity to RoHS Directive

MPZ Series MPZ1608

FEATURES

- This type is the best for energy-saving in the low DC resistance.
- The products contain no lead and also support lead-free soldering.
- It is a product conforming to RoHS directive.

APPLICATIONS

Removal of power line noises of cellular phones, PCs, note PCs, TVs, TV tuners, STBs, audio players, DVDs, DSCs, DVCs, game machines, digital photo frames, car navigation system, PNDs, etc.

PRODUCT IDENTIFICATION

| | | | | | | |
|-----|------|-----|-----|-----|-----|-----|
| MPZ | 1608 | S | 221 | A | T | □□□ |
| (1) | (2) | (3) | (4) | (5) | (6) | (7) |

- (1) Series name
- (2) Dimensions L×W
- (3) Type name
- (4) Impedance
221: 220Ω at 100MHz
- (5) Characteristic type
- (6) Packaging style
T: Taping
- (7) TDK internal code

HANDLING AND PRECAUTIONS

- Before soldering, be sure to preheat components. The preheating temperature should be set so that the temperature difference between the solder temperature and product temperature does not exceed 150°C.
- After mounting components onto the printed circuit board, do not apply stress through board bending or mishandling.
- Do not expose the inductors to stray magnetic fields.
- Avoid static electricity discharge during handling.
- When hand soldering, apply the soldering iron to the printed circuit board only. Temperature of the iron tip should not exceed 350°C. Soldering time should not exceed 3 seconds.

MATERIAL CHARACTERISTICS

B material: This type is perfectly suited for fast digital signals. By equalizing R components and X components that beads possess at a frequency of 5MHz, it is able to suppress overshooting, undershooting and ringing of fast digital signals.

R material: For wide frequency applications calling for broad impedance characteristics.

For digital signal line applications calling requiring good waveform integrity. Impedance values selected for effectiveness at 10 to 200MHz.

S material: Standard type that features impedance characteristics similar to those of a typical ferrite core.

For signal line applications in which the blocking region is near 100MHz. Impedance values selected for effectiveness at 40 to 300MHz.

Y material: High frequency range type intended for the 100MHz region and above.

For signal line applications in which the signal frequency is far from the cutoff frequency. Impedance values selected for effectiveness at 80 to 400MHz.

D material: For applications calling for low insertion loss at low frequencies and sharply increasing impedance at high frequencies. Designed for high impedance at high frequencies (300MHz to 1GHz) for signal line applications.

TYPICAL MATERIAL CHARACTERISTICS

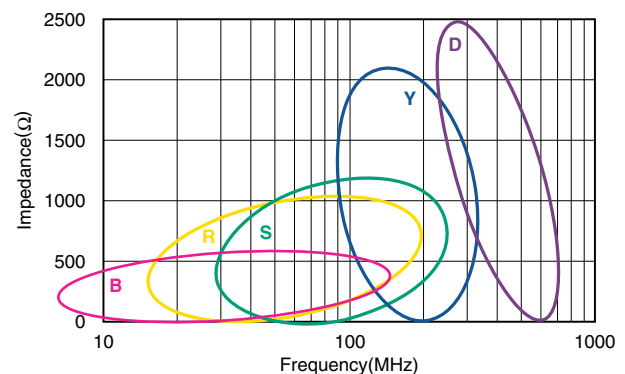

• Conformity to RoHS Directive: This means that, in conformity with EU Directive 2002/95/EC, lead, cadmium, mercury, hexavalent chromium, and specific bromine-based flame retardants, PBB and PBDE, have not been used, except for exempted applications.

• Please contact our Sales office when your application is considered the following:
The device's failure or malfunction may directly endanger human life (e.g. application for automobile/aircraft/medical/nuclear power devices, etc.)

• All specifications are subject to change without notice.

SHAPES AND DIMENSIONS/RECOMMENDED PC BOARD PATTERN

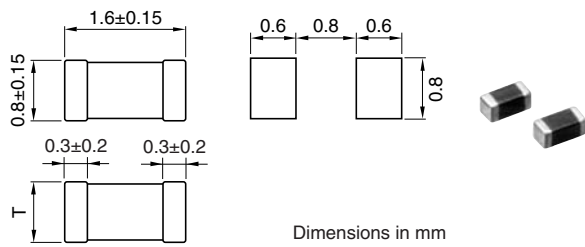

| Thickness(T) | Weight |
|--------------|--------|
| 0.6±0.15mm | 3mg |
| 0.8±0.15mm | 4mg |

SPECIFICATIONS

| | |
|-----------------------------|----------------------------|
| Operating temperature range | -55 to +125°C |
| Storage temperature range | -55 to +125°C(After mount) |

PACKAGING STYLE AND QUANTITIES

| | |
|-----------------|------------------|
| Packaging style | Quantity |
| Taping | 4000 pieces/reel |

RECOMMENDED SOLDERING CONDITION REFLOW SOLDERING

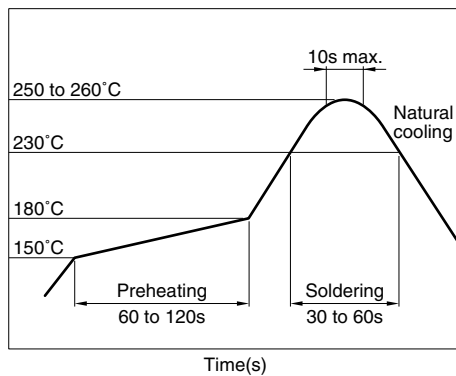

ELECTRICAL CHARACTERISTICS

| Part No. | Impedance (Ω)[100MHz]*1 | DC resistance (Ω)max. | Rated current*2 (A)max. | Thickness T(mm) |
|--------------|-------------------------------------|-----------------------------------|----------------------------|--------------------|
| MPZ1608B471A | 470±25% | 0.150 | 1.0 | 0.8 |
| MPZ1608S300A | 30±10 Ω | 0.010 | 5.0 | 0.6 |
| MPZ1608S600A | 60±25% | 0.020 | 3.5 | 0.6 |
| MPZ1608S101A | 100±25% | 0.030 | 3.0 | 0.6 |
| MPZ1608S121A | 120±25% | 0.045 | 2.0 | 0.6 |
| MPZ1608S181A | 180±25% | 0.050 | 2.0 | 0.6 |
| MPZ1608S221A | 220±25% | 0.050 | 2.2 | 0.8 |
| MPZ1608S331A | 330±25% | 0.080 | 1.7 | 0.8 |
| MPZ1608R391A | 390±25% | 0.120 | 1.2 | 0.8 |
| MPZ1608S471A | 470±25% | 0.150 | 1.0 | 0.8 |
| MPZ1608S601A | 600±25% | 0.150 | 1.0 | 0.8 |
| MPZ1608S102A | 1000±25% | 0.300 | 0.8 | 0.8 |
| MPZ1608Y600B | 60±25% | 0.030 | 2.3 | 0.8 |
| MPZ1608Y101B | 100±25% | 0.040 | 2.0 | 0.8 |
| MPZ1608Y151B | 150±25% | 0.050 | 1.8 | 0.8 |
| MPZ1608Y221B | 220±25% | 0.100 | 1.5 | 0.8 |
| MPZ1608D300B | 30±10 Ω | 0.060 | 1.8 | 0.8 |
| MPZ1608D600B | 60±25% | 0.100 | 1.2 | 0.8 |
| MPZ1608D101B | 100±25% | 0.150 | 1.0 | 0.8 |

*1 Test equipment: E4991A or equivalent
Test tool: 16192A or equivalent
Test temperature: 25±10°C

*2 Please refer to the graph of RATED CURRENT vs. TEMPERATURE CHARACTERISTICS(DERATING) about the rating current at 85°C or more in temperature of the product.

RATED CURRENT vs. TEMPERATURE CHARACTERISTICS (DERATING)



| | | | |
|-------------------------------|---------------------|-------------------|---------|
| — S300A | — S600A | — S101A | — Y600B |
| — S221A | — S121A,S181A,Y101B | — Y151B,D300B | |
| - - - S331A | - - - Y221B | - - - R391A,D600B | |
| - - - B471A,S471A,S601A,D101B | - - - S102A | | |

TYPICAL ELECTRICAL CHARACTERISTICS

Z, X, R vs. FREQUENCY CHARACTERISTICS

MPZ1608B471A

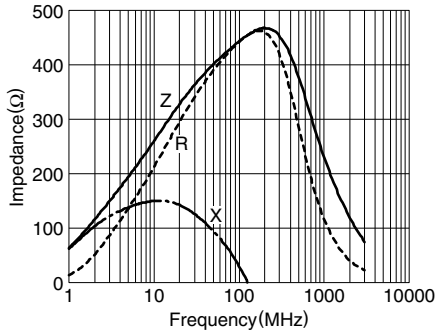

MPZ1608S300A



MPZ1608S600A



MPZ1608S101A

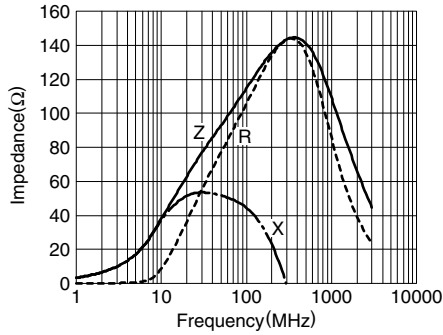

MPZ1608S121A

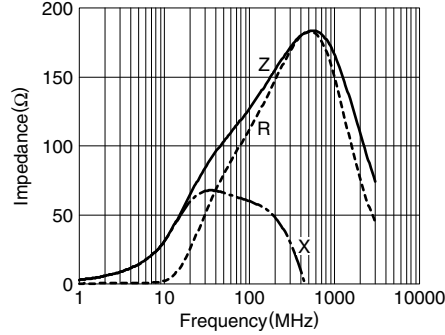

MPZ1608S181A



MPZ1608S221A



MPZ1608S331A

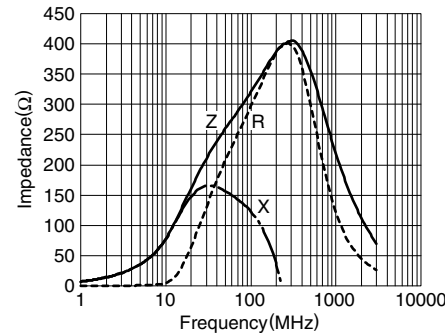

MPZ1608R391A



MPZ1608S471A

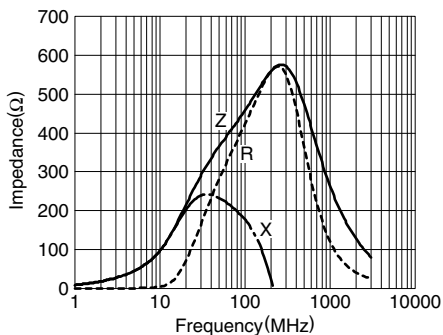

MPZ1608S601A

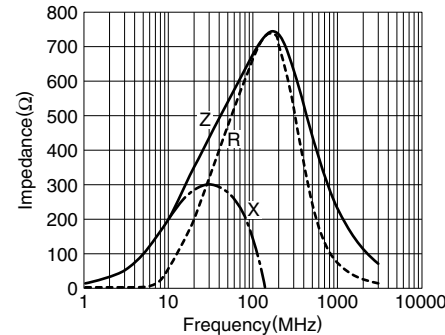

MPZ1608S102A



• All specifications are subject to change without notice.

TYPICAL ELECTRICAL CHARACTERISTICS
Z, X, R vs. FREQUENCY CHARACTERISTICS
MPZ1608Y600B

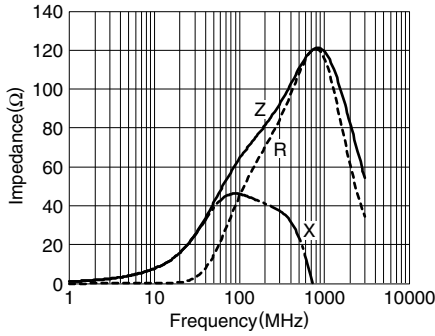

MPZ1608Y101B

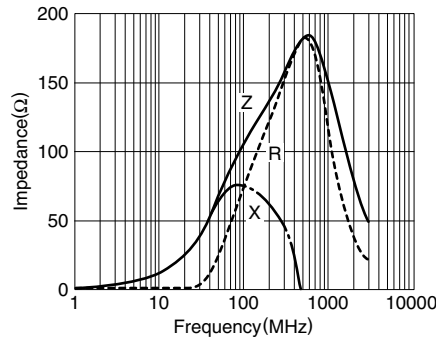

MPZ1608Y151B

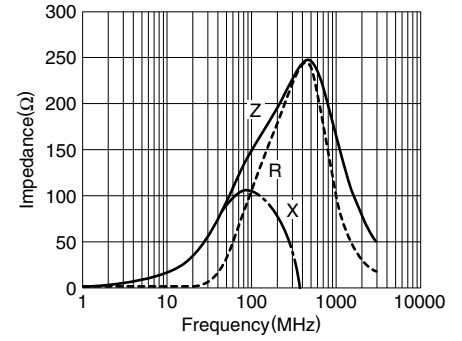

MPZ1608Y221B

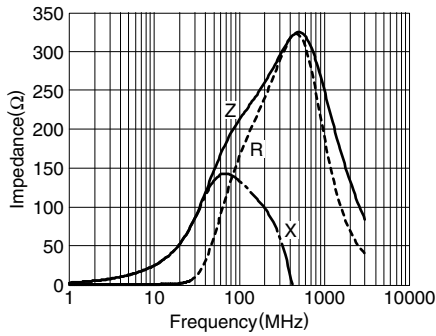

MPZ1608D300B

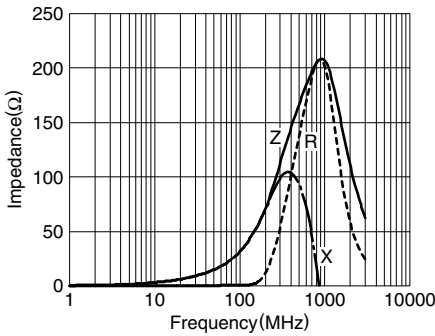

MPZ1608D600B

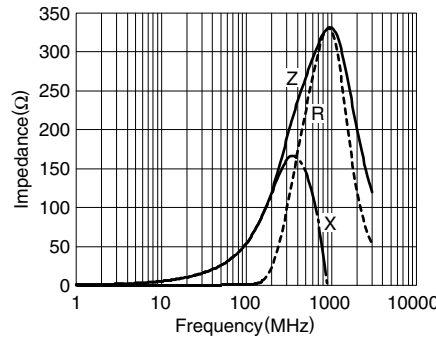

MPZ1608D101B

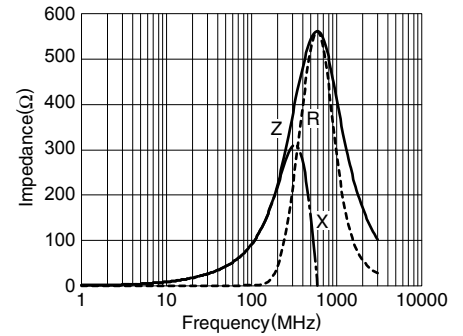

PACKAGING STYLES
REEL DIMENSIONS

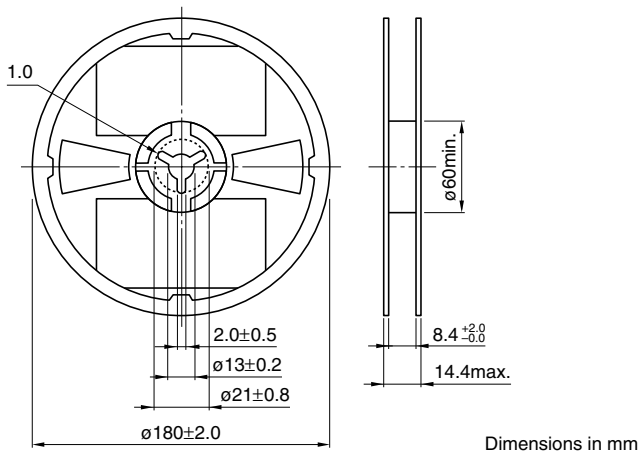

Dimensions in mm

TAPE DIMENSIONS

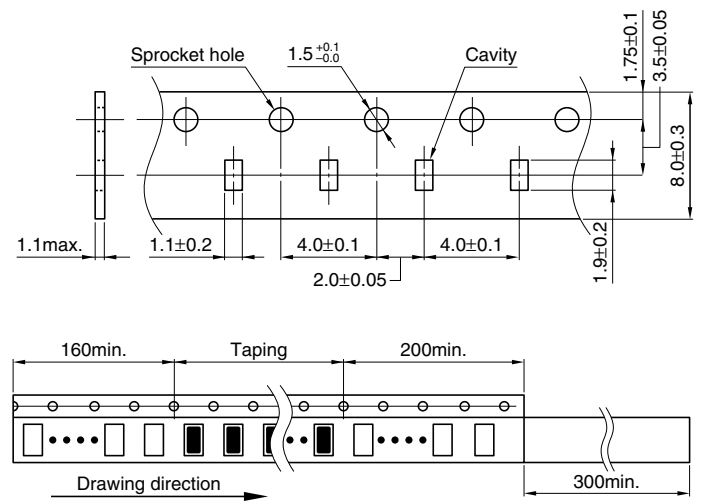

Dimensions in mm

• All specifications are subject to change without notice.

Chip Beads

For Power Line

Conformity to RoHS Directive

MPZ Series MPZ2012

FEATURES

- The MPZ series are multilayer chip impeders for power supply line applications.
- High miniaturized, these parts nonetheless exhibit low DC resistance and high current handling capability.
- The products contain no lead and also support lead-free soldering.
- It is a product conforming to RoHS directive.

APPLICATIONS

Removal of power line noises of cellular phones, PCs, note PCs, TVs, TV tuners, STBs, audio players, DVDs, DSCs, DVCs, game machines, digital photo frames, car navigation system, PNDs, etc.

PRODUCT IDENTIFICATION

MPZ 2012 S 331 A T □□□
 (1) (2) (3) (4) (5) (6) (7)

(1) Series name

(2) Dimensions L×W

(3) Type name

(4) Impedance

331: 330Ω at 100MHz

(5) Characteristic type

(6) Packaging style

T: Taping

(7) TDK internal code

HANDLING AND PRECAUTIONS

- Before soldering, be sure to preheat components. The preheating temperature should be set so that the temperature difference between the solder temperature and product temperature does not exceed 150°C.
- After mounting components onto the printed circuit board, do not apply stress through board bending or mishandling.
- Do not expose the inductors to stray magnetic fields.
- Avoid static electricity discharge during handling.
- When hand soldering, apply the soldering iron to the printed circuit board only. Temperature of the iron tip should not exceed 350°C. Soldering time should not exceed 3 seconds.

SHAPES AND DIMENSIONS/RECOMMENDED PC BOARD PATTERN

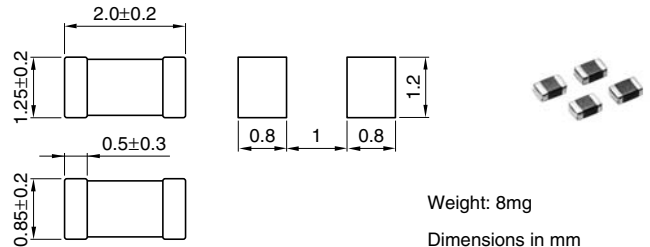

SPECIFICATIONS

| | |
|-----------------------------|-----------------------------|
| Operating temperature range | -55 to +125°C |
| Storage temperature range | -55 to +125°C (After mount) |

PACKAGING STYLE AND QUANTITIES

| | |
|-----------------|------------------|
| Packaging style | Quantity |
| Taping | 4000 pieces/reel |

RECOMMENDED SOLDERING CONDITION REFLOW SOLDERING

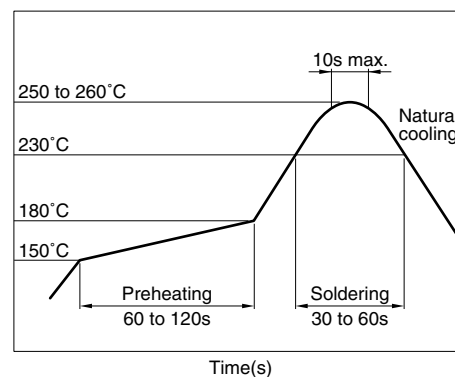

• Conformity to RoHS Directive: This means that, in conformity with EU Directive 2002/95/EC, lead, cadmium, mercury, hexavalent chromium, and specific bromine-based flame retardants, PBB and PBDE, have not been used, except for exempted applications.

• Please contact our Sales office when your application is considered the following:
The device's failure or malfunction may directly endanger human life (e.g. application for automobile/aircraft/medical/nuclear power devices, etc.)

• All specifications are subject to change without notice.

ELECTRICAL CHARACTERISTICS

| Part No. | Impedance (Ω)[100MHz] ^{*1} | DC resistance (Ω)max. | Rated current ^{*2} (A)max. |
|--------------|-------------------------------------|-----------------------|-------------------------------------|
| MPZ2012S300A | 30±10Ω | 0.010 | 6 |
| MPZ2012S101A | 100±25% | 0.020 | 4 |
| MPZ2012S221A | 220±25% | 0.040 | 3 |
| MPZ2012S331A | 330±25% | 0.050 | 2.5 |
| MPZ2012S601A | 600±25% | 0.100 | 2 |
| MPZ2012S102A | 1000±25% | 0.150 | 1.5 |

^{*1} Test equipment: E4991A or equivalent
 Test tool: 16192A or equivalent
 Test temperature: 25±10°C

^{*2} Please refer to the graph of RATED CURRENT vs. TEMPERATURE CHARACTERISTICS(DERATING) about the rating current at 85°C or more in temperature of the product.

RATED CURRENT vs. TEMPERATURE CHARACTERISTICS (DERATING)



TYPICAL ELECTRICAL CHARACTERISTICS Z, X, R vs. FREQUENCY CHARACTERISTICS

MPZ2012S300A



MPZ2012S101A

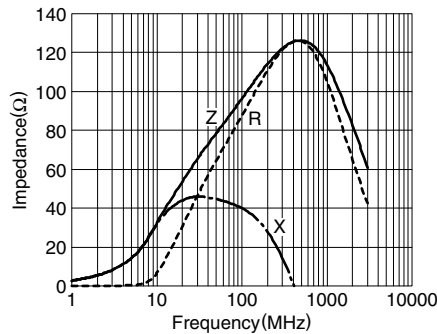

MPZ2012S221A

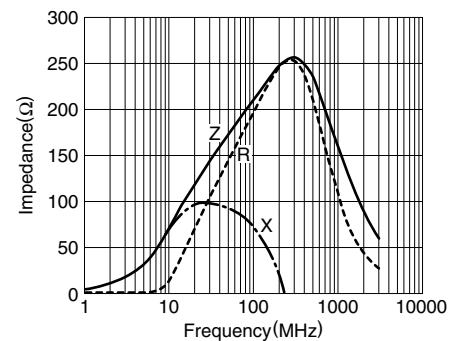

MPZ2012S331A

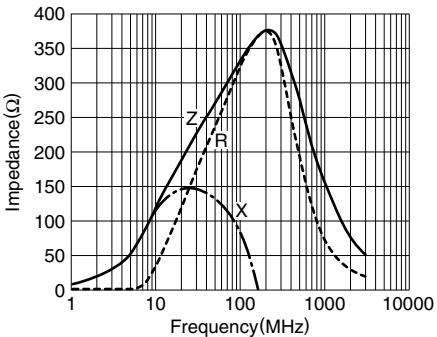

MPZ2012S601A

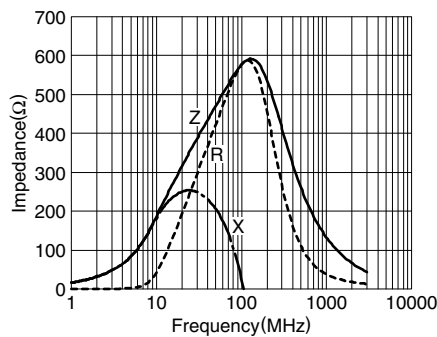

MPZ2012S102A

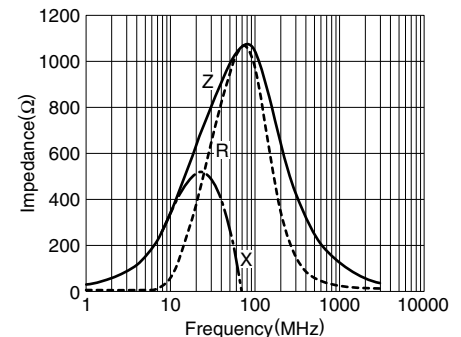

PACKAGING STYLES

REEL DIMENSIONS



TAPE DIMENSIONS

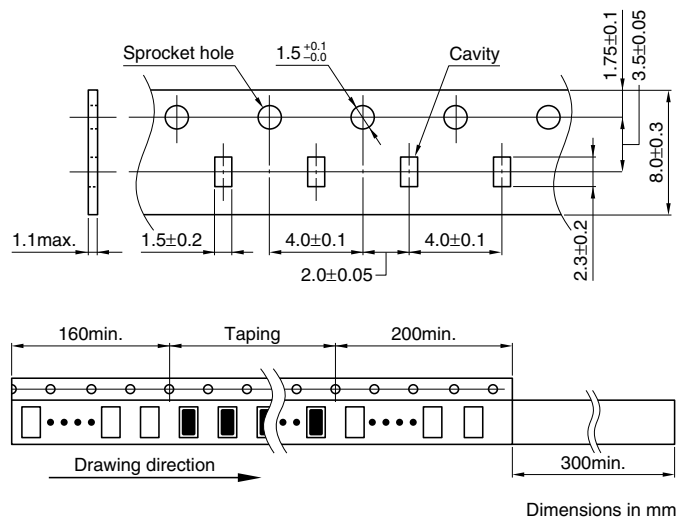

• All specifications are subject to change without notice.

Chip Beads

For Power Line

Conformity to RoHS Directive

MPZ Series MPZ1005-E

FEATURES

- TDK has manufactured MPZ1005 type as EMI countermeasure product for power line.
- Compared with the existing MPZ1005 type, this new product has broad-band impedance values for higher frequency ranges.
- This type is the best for energy-saving in the low DC resistance.
- No cross talk with closed magnetic circuit structural design.
- It is a product conforming to RoHS directive.

APPLICATIONS

Removal of power line noises of cellular phones, PCs, note PCs, TVs, TV tuners, STBs, audio players, DVDs, DSCs, DVCs, game machines, digital photo frames, PNDs, etc.

PRODUCT IDENTIFICATION

| | | | | | | | | |
|-----|------|-----|-----|-----|-----|--------------------------|--------------------------|--------------------------|
| MPZ | 1005 | S | 221 | E | T | <input type="checkbox"/> | <input type="checkbox"/> | <input type="checkbox"/> |
| (1) | (2) | (3) | (4) | (5) | (6) | (7) | | |

- (1) Series name
- (2) Dimensions L×W
- (3) Type name
- (4) Impedance
221:220Ω at 100MHz
- (5) Characteristic type
- (6) Packaging style
T:Taping(reel)
- (7) TDK internal code

HANDLING AND PRECAUTIONS

- Before soldering, be sure to preheat components. The preheating temperature should be set so that the temperature difference between the solder temperature and product temperature does not exceed 150°C.
- After mounting components onto the printed circuit board, do not apply stress through board bending or mishandling.
- Do not expose the inductors to stray magnetic fields.
- Avoid static electricity discharge during handling.
- When hand soldering, apply the soldering iron to the printed circuit board only. Temperature of the iron tip should not exceed 350°C. Soldering time should not exceed 3 seconds.

SHAPES AND DIMENSIONS/RECOMMENDED PC BOARD PATTERN



SPECIFICATIONS

| | |
|-----------------------------|----------------------------|
| Operating temperature range | -55 to +125°C |
| Storage temperature range | -55 to +125°C(After mount) |

PACKAGING STYLE AND QUANTITIES

| | |
|-----------------|-------------------|
| Packaging style | Quantity |
| Taping | 10000 pieces/reel |

RECOMMENDED SOLDERING CONDITION

REFLOW SOLDERING



• Conformity to RoHS Directive: This means that, in conformity with EU Directive 2002/95/EC, lead, cadmium, mercury, hexavalent chromium, and specific bromine-based flame retardants, PBB and PBDE, have not been used, except for exempted applications.

• Please contact our Sales office when your application is considered the following:
The device's failure or malfunction may directly endanger human life (e.g. application for automobile/aircraft/medical/nuclear power devices, etc.)

• All specifications are subject to change without notice.

ELECTRICAL CHARACTERISTICS

| Part No. | Impedance(Ω)*1 | | DC resistance (Ω)max. | Rated current (A)max.*2 |
|--------------|-------------------------|---------------|-----------------------------------|----------------------------|
| | [100MHz] | [1GHz] | | |
| MPZ1005S221E | 220 \pm 25% | 350 \pm 40% | 0.22 | 0.9 |
| MPZ1005S331E | 330 \pm 25% | 550 \pm 40% | 0.28 | 0.7 |

*1 Test equipment: E4991A or equivalent
 Test tool: 16192A or equivalent
 Test temperature: 25 \pm 10°C

*2 Please refer to the graph of RATED CURRENT vs. TEMPERATURE CHARACTERISTICS(DERATING) about the rating current at 85°C or more in temperature of the product.

RATED CURRENT vs. TEMPERATURE CHARACTERISTICS (DERATING)



TYPICAL ELECTRICAL CHARACTERISTICS Z FREQUENCY CHARACTERISTICS MPZ1005S-E SERIES



Z, X, R vs. FREQUENCY CHARACTERISTICS MPZ1005S221E



MPZ1005S331E

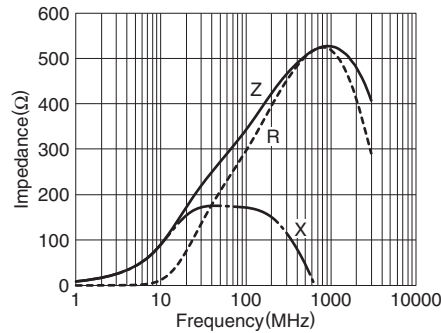

PACKAGING STYLES REEL DIMENSIONS



TAPE DIMENSIONS



• All specifications are subject to change without notice.

Компания «Life Electronics» занимается поставками электронных компонентов импортного и отечественного производства от производителей и со складов крупных дистрибьюторов Европы, Америки и Азии.

С конца 2013 года компания активно расширяет линейку поставок компонентов по направлению коаксиальный кабель, кварцевые генераторы и конденсаторы (керамические, пленочные, электролитические), за счёт заключения дистрибьюторских договоров

Мы предлагаем:

- Конкурентоспособные цены и скидки постоянным клиентам.
- Специальные условия для постоянных клиентов.
- Подбор аналогов.
- Поставку компонентов в любых объемах, удовлетворяющих вашим потребностям.
- Приемлемые сроки поставки, возможна ускоренная поставка.
- Доставку товара в любую точку России и стран СНГ.
- Комплексную поставку.
- Работу по проектам и поставку образцов.
- Формирование склада под заказчика.
- Сертификаты соответствия на поставляемую продукцию (по желанию клиента).
- Тестирование поставляемой продукции.
- Поставку компонентов, требующих военную и космическую приемку.
- Входной контроль качества.
- Наличие сертификата ISO.

В составе нашей компании организован Конструкторский отдел, призванный помогать разработчикам, и инженерам.

Конструкторский отдел помогает осуществить:

- Регистрацию проекта у производителя компонентов.
- Техническую поддержку проекта.
- Защиту от снятия компонента с производства.
- Оценку стоимости проекта по компонентам.
- Изготовление тестовой платы монтаж и пусконаладочные работы.



Тел: +7 (812) 336 43 04 (многоканальный)

Email: org@lifeelectronics.ru