

SB6000 SERIES

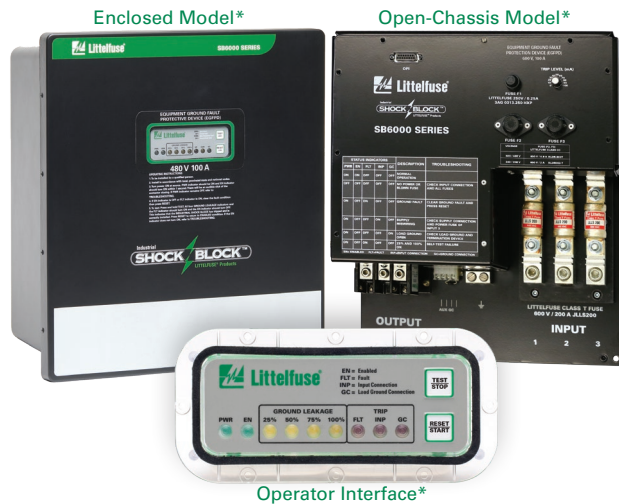

*Patented

Simplified Circuit Diagram

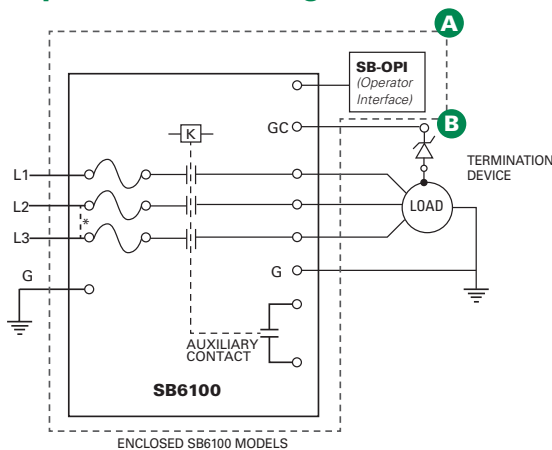

Ordering Information

ORDERING NUMBER	VOLTAGE (V)	TRIP LEVEL (mA)	UL CATEGORY/CLASS
SB6100-00x-0	208	20 (Fixed)	UL 943C Class C special-purpose GFCI
SB6100-10x-0	240		
SB6100-20x-0	480		
SB6100-30x-0	600		UL 943C Class D special-purpose GFCI
SB6100-01x-0	208	6, 10-100 in increments of 10	UL 943/UL 1053 Equipment ground-fault protective device (EGFPD)
SB6100-11x-0	240		
SB6100-21x-0	480		
SB6100-31x-0	600		

Note: x=0 for open-chassis models and 1 for enclosed models

Description

Special-Purpose Ground-Fault Circuit Interrupter (GFCI), Class C and Class D

Industrial Shock Block (ISB) is a personnel protection device designed to meet the new requirements for special-purpose GFCIs defined by UL 943C. ISB is the first permanently connected Class C and Class D GFCI on the market. Class C GFCIs are intended to be used on three-phase systems where the line-to-line voltage is 480 V or less with a trip level of 20 mA, while Class D GFCIs are intended to be used on 600 V systems. These improvements to the standard Class A GFCI (6 mA trip level used on 240 V systems or less) were made to allow the use of GFCIs in industrial facilities. The ISB includes an automatic self-test feature and is compliant to the UL1998 Software in Programmable Components standard.

Equipment Ground-Fault Protective Device (EGFPD)

ISB is also available with adjustable protection settings as an EGFPD. The EGFPD models can be set to trip at 6 mA or from 10-100 mA in increments of 10 mA. This offers more flexibility since GFCI devices are not allowed to have an adjustable trip level.

Rating and Models

ISB (GFCI & EGFPD) is available for three-phase voltages from 208 to 600 V with a maximum full load current of 100 A, and a built-in overcurrent protection supplied by Littelfuse Class T fuses. The load must be 3-phase, however, cannot have a neutral. The power system can either be solidly-grounded or high-resistance grounded.

Two options for enclosures are available: UL-recognized open-chassis models are available for installation in existing electrical enclosures and UL-listed enclosed models include a NEMA-4X enclosure for stand-alone installations.

Ground Wire (Load-Ground) Monitor

The ISB also monitors the ground wire (load-ground) connection between the ISB and load. This is a required feature for GFCI devices and is optional for EGFPD devices. If the connection is broken, the ISB will provide an alarm by changing the state of the alarm contacts. This monitoring circuit includes an extra wire (pilot wire) between the ISB and load (since the monitoring current is low, only a small wire is required). At the load, the pilot wire is connected to a termination device. The other end of the termination device is connected to the load ground (typically the enclosure).

Features & Benefits

FEATURES	BENEFITS
UL 943 inverse time trip curve	Detects and interrupts to protect people and reduce the probability of nuisance tripping
Minimum trip time < 20 msec	Reduces the risk of ventricular fibrillation for leakage current of 250 mA and above
UL 943C fixed trip level (GFCI 20 mA)	Personnel protection for systems with leakage current higher than the standard 6 mA required by UL 943 Class A
Selectable trip levels (EGFPD)	Provides extra safety when a customer is able to operate with a setting below 20 mA (GFCI) and the settings above 20 mA can reduce nuisance tripping on systems with high leakage current.
UL 943C ground monitor/interrupt	Protects from shock by tripping if continuity of ground wire between Industrial Shock-Block and load is broken.
Undervoltage, brownout, chatter detection	Ensures proper operation and prolongs the internal contactor lifetime
3 x Class T, 600V incoming fuses	The fuses provide overcurrent protection for a 100 A circuit and a higher short-circuit current rating (SCCR) of 50 kA.
Conformal coating	Internal circuits are conformally coated to protect against corrosion and moisture, yet still repairable
Operator Interface	Shows unit status, alarm types, percentage of leakage current, and allows for Test and Reset capabilities
Auxiliary Contact	Provides a normally-open contact for remote indication
Automatic Self-Test	All ISB options (revision 01 or higher) include an automatic self-test feature
Motor Starter	Allows the user to start and stop the motor from the interface

SB6000 SERIES

Accessories

A  **Operator Interface (AC6000-OPI-00)**

B  **1N5339B - Termination Device**
Axial-lead ground-check termination, included with SB6000 series

 **SE-TA6 - Termination Assembly**
Optional termination assembly with terminals and mounting holes

 **SE-TA6-SM Stud-Mount Termination Assembly**
Optional ground-check termination for submersible pumps

 **AC6000-CART-00 Two-wheeled Cart**
Optional for mounting ISB to allow for moving the unit while power is off



 **AC6000-MNT-00 Mounting Frame**
Optional for mounting ISB to a cart or other surface. Included with the AC6000-CART-00.

Ordering Information - Accessories

ACCESSORIES	REQUIREMENT	PAGE*
AC6000-OPI-00	Included	N/A
1N5339B	Included	120
SE-TA6	Optional	120
SE-TA6-SM	Optional	120
SE-TA6ASF-WL	Optional	120
AC6000-CART-00	Optional	N/A
AC6000-MNT-00	Optional	N/A

Connection Diagram

The SB6100 is installed in-line between incoming power or existing over-current protection device and the load.

The open-chassis SB6100 can be installed in electrical equipment and the enclosed version is typically wall-mounted.

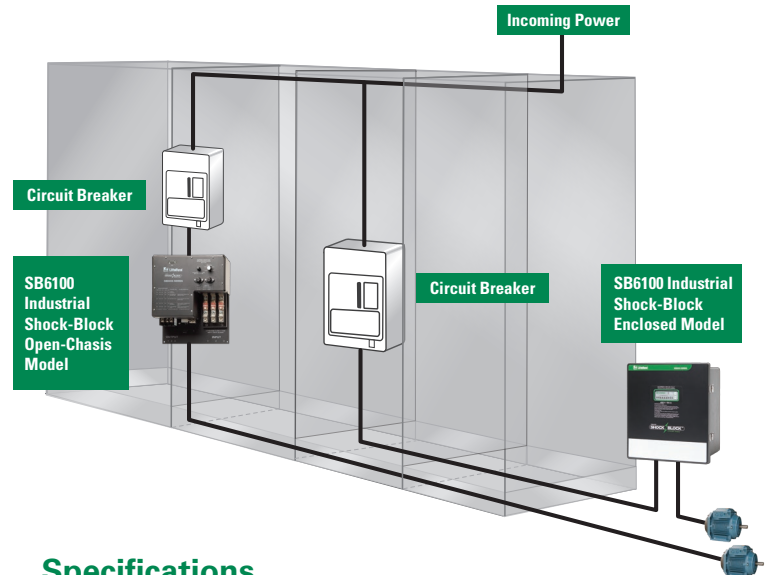

Specifications

Voltage Rating	See ordering information
Current Rating	100 A (continuous)
Load	3-phase, 3-wire (no neutral), 60 Hz
Short-Circuit Current Rating	50,000 A
Trip Level Settings	Selectable (6, 10, 20, 30, 40, 50, 60, 70, 80, 90, 100 mA), or fixed at 20 mA
Trip Time Setting	Inverse time trip curve
Enclosure	NEMA 4X, Polyester, Lockable
Operating Temperature	-35°C (-31°F) to +40°C (104°F), up to +66°C (151°F) with derating
Wiring Requirements	2/0 AWG (maximum)
Approval	GFCI: UL Listed (enclosed models) and UL Recognized component (open-chassis models) EGFPD: cULus Listed (enclosed models) and cURus Recognized Component (open-chassis models); UL1998 Compliant (revision 01 or higher); All models CSA Certified
Dimensions	Enclosed: H 453.8 mm (17.9"); W 406.2 mm (16.0"); D 223.3 mm (8.8") Open-chassis: H 455.0 mm (17.9"); W 340.7 mm (13.4"); D 174.9 mm (6.8")
Warranty	1 year

Disclaimer Notice – Information furnished is believed to be accurate and reliable. However, users should independently evaluate the suitability of and test each product selected for their own applications. Littelfuse products are not designed for, and may not be used in, all applications. Read complete Disclaimer Notice at www.littelfuse.com/product-disclaimer.

Компания «Life Electronics» занимается поставками электронных компонентов импортного и отечественного производства от производителей и со складов крупных дистрибьюторов Европы, Америки и Азии.

С конца 2013 года компания активно расширяет линейку поставок компонентов по направлению коаксиальный кабель, кварцевые генераторы и конденсаторы (керамические, пленочные, электролитические), за счёт заключения дистрибьюторских договоров

Мы предлагаем:

- Конкурентоспособные цены и скидки постоянным клиентам.
- Специальные условия для постоянных клиентов.
- Подбор аналогов.
- Поставку компонентов в любых объемах, удовлетворяющих вашим потребностям.
- Приемлемые сроки поставки, возможна ускоренная поставка.
- Доставку товара в любую точку России и стран СНГ.
- Комплексную поставку.
- Работу по проектам и поставку образцов.
- Формирование склада под заказчика.
- Сертификаты соответствия на поставляемую продукцию (по желанию клиента).
- Тестирование поставляемой продукции.
- Поставку компонентов, требующих военную и космическую приемку.
- Входной контроль качества.
- Наличие сертификата ISO.

В составе нашей компании организован Конструкторский отдел, призванный помогать разработчикам, и инженерам.

Конструкторский отдел помогает осуществить:

- Регистрацию проекта у производителя компонентов.
- Техническую поддержку проекта.
- Защиту от снятия компонента с производства.
- Оценку стоимости проекта по компонентам.
- Изготовление тестовой платы монтаж и пусконаладочные работы.



Тел: +7 (812) 336 43 04 (многоканальный)

Email: org@lifeelectronics.ru