

Wire Wound Common Mode Choke for USB3.0

ACM-21U



RoHS/RoHS II compliant



2.0 x 1.2 x 1.2mm

FEATURES:

- Small size and low profile
- Virtually no effect on high speed signals due to suppressed differential mode impedance
- Elimination of common mode noise in high speed, differential mode signal transmission lines such as USB3.0

APPLICATIONS:

- High speed differential signal lines in USB3.0

STANDARD SPECIFICATIONS

Abrakon P/N:	ACM-21U
Operating Temperature & Humidity:	-40°C to +85°C
Storage Temperature & Humidity:	-10°C to +40°C, Humidity < 70%RH (In tape and reel)

Part Number	Impedance @100MHz	DCR	I _R	Rated Voltage	Insulation Resistance
Units	Ω ± 25%	Ω (max.)	mA	Vdc	MΩ (min.)
ACM-21U-900	90	0.40	280	20	10

Test Conditions

Impedance (Common mode and differential mode): LCR Meter Agilent 4287A/E4991A

DCR: Agilent 4338B/34420

I_R: Electric power, Electrical current meter, Thermometer

Definition of Rated Current (I_R): The direct electric current as chip surface temperature rise just 20°C against chip initial surface temperature.

Insertion Loss: Network Analyzer Agilent E5071C

Insulation Resistance: High resistance meter Agilent 4339B

PART IDENTIFICATION:

ACM-21U- -



Impedance Code

Please refer to the table above

Packaging

Blank: bulk
T: Tape and Reel (2k pcs/reel)

Wire Wound Common Mode Choke for USB3.0

ACM-21U



RoHS/RoHS II compliant



2.0 x 1.2 x 1.2mm

ELECTRICAL CHARACTERISTIC CURVE:

Impedance vs. Frequency

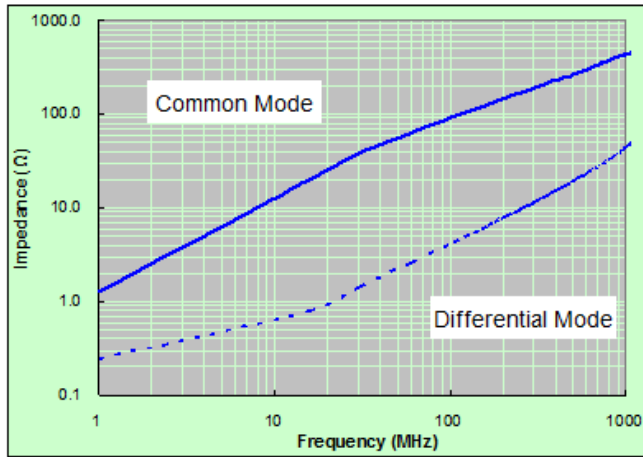

Insertion Loss

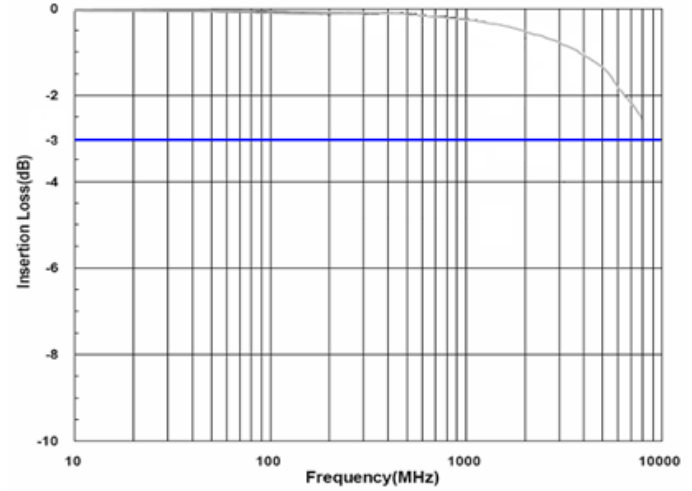

Characteristic Impedance

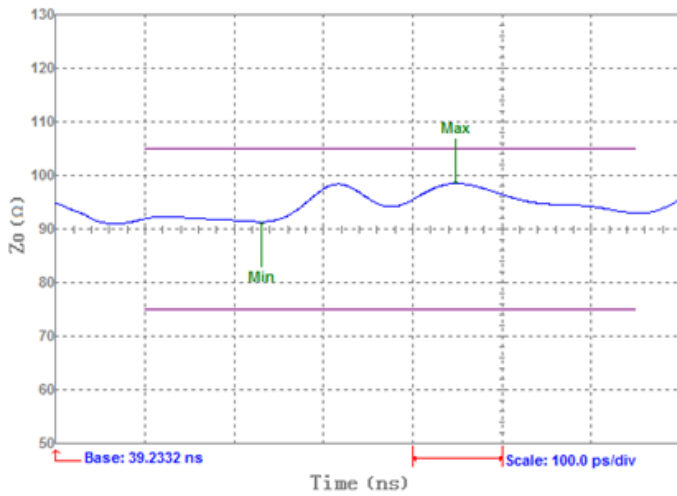

Eye Diagram in USB3.0

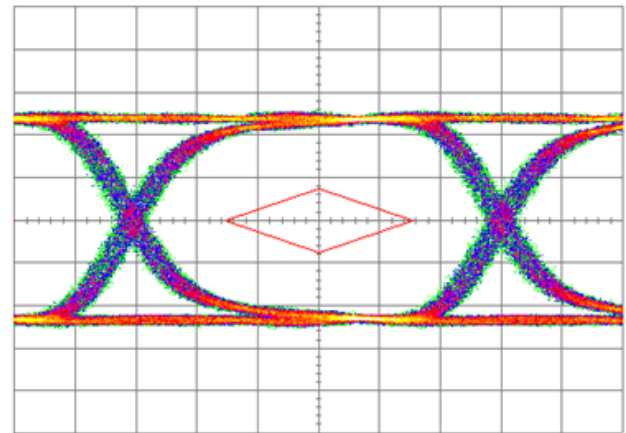

Wire Wound Common Mode Choke for USB3.0

ACM-21U



RoHS/RoHS II compliant



2.0 x 1.2 x 1.2mm

OUTLINE DIMENSIONS:

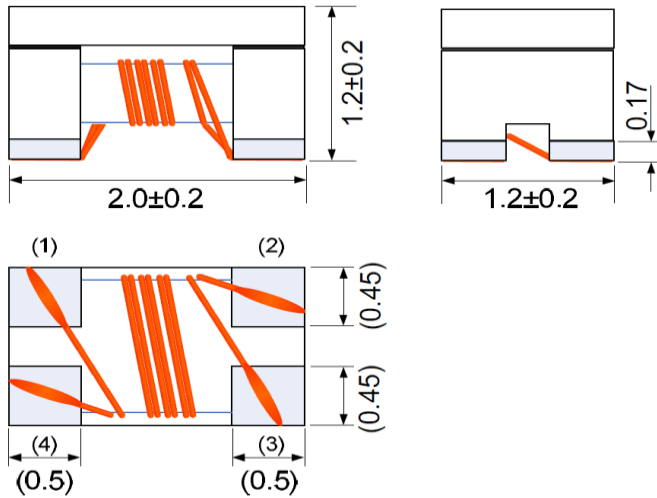

Recommended Land Pattern

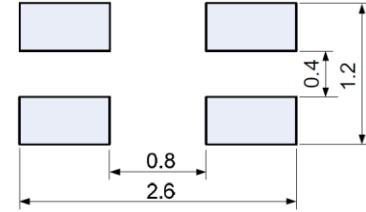

Schematic

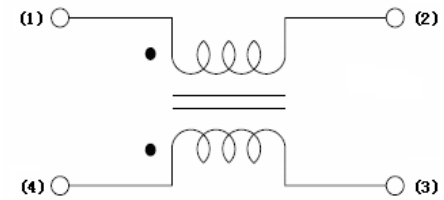

Materials

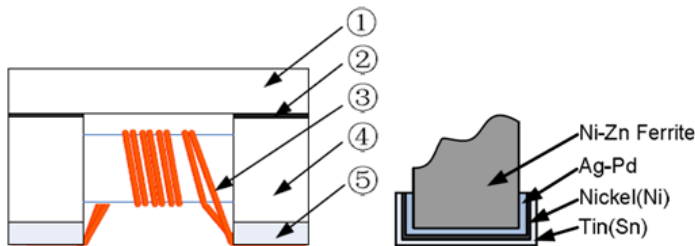

No.	Part Name	Material Name
①	Lid	Ni-Zn Ferrite
②	Epoxy	Epoxy resin
③	Wire	Polyurethane system enameled copper wire
④	Core	Ni-Zn Ferrite
⑤	Electrode structure	(Ag-Pd)+Ni+Sn plating

REFLOW PROFILE:

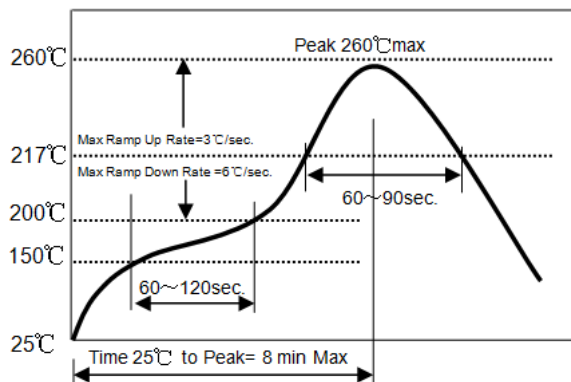

- △ Preheat condition: $150 \sim 200$ C/ $60 \sim 120$ sec.
- △ Allowed time above 217°C : $60 \sim 90$ sec.
- △ Max temp: 260°C
- △ Max time at max temp: 10sec.
- △ Solder paste: Sn/3.0Ag/0.5Cu
- △ Allowed Reflow time: 2 times max.

ABRACON IS
ISO 9001:2008
CERTIFIED



Visit www.abracon.com for Terms & Conditions of Sale
30332 Esperanza, Rancho Santa Margarita, California 92688
tel 949-546-8000 | fax 949-546-8001 | www.abracon.com

Revised: 02.20.14

Wire Wound Common Mode Choke for USB3.0

ACM-21U



RoHS/RoHS II compliant



2.0 x 1.2 x 1.2mm

TAPE & REEL: 2000pcs/reel



A	B	P	K	T
1.55±0.2	2.25±0.2	4.0±0.1	1.45±0.1	0.2±0.1

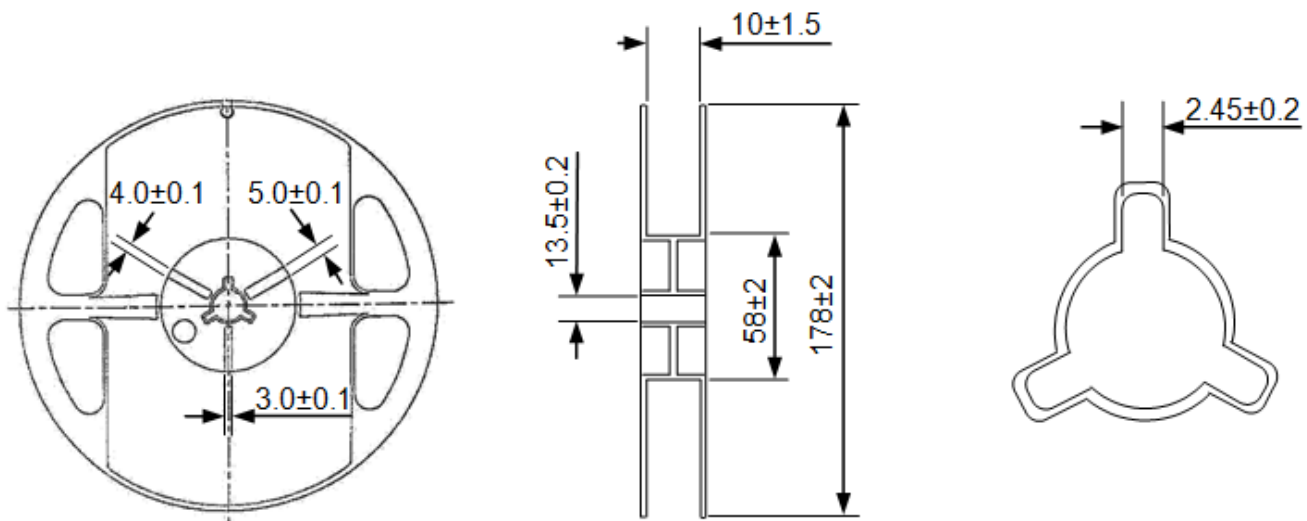

Dimension: mm

ATTENTION: Abracon Corporation's products are COTS – Commercial-Off-The-Shelf products; suitable for Commercial, Industrial and, where designated, Automotive Applications. Abracon's products are not specifically designed for Military, Aviation, Aerospace, Life-dependant Medical applications or any application requiring high reliability where component failure could result in loss of life and/or property. For applications requiring high reliability and/or presenting an extreme operating environment, written consent and authorization from Abracon Corporation is required. Please contact Abracon Corporation for more information.

ABRACON IS
ISO 9001:2008
CERTIFIED



Visit www.abracon.com for Terms & Conditions of Sale **Revised: 02.20.14**
30332 Esperanza, Rancho Santa Margarita, California 92688
tel 949-546-8000 | fax 949-546-8001 | www.abracon.com

Компания «Life Electronics» занимается поставками электронных компонентов импортного и отечественного производства от производителей и со складов крупных дистрибьюторов Европы, Америки и Азии.

С конца 2013 года компания активно расширяет линейку поставок компонентов по направлению коаксиальный кабель, кварцевые генераторы и конденсаторы (керамические, пленочные, электролитические), за счёт заключения дистрибьюторских договоров

Мы предлагаем:

- Конкурентоспособные цены и скидки постоянным клиентам.
- Специальные условия для постоянных клиентов.
- Подбор аналогов.
- Поставку компонентов в любых объемах, удовлетворяющих вашим потребностям.
- Приемлемые сроки поставки, возможна ускоренная поставка.
- Доставку товара в любую точку России и стран СНГ.
- Комплексную поставку.
- Работу по проектам и поставку образцов.
- Формирование склада под заказчика.
- Сертификаты соответствия на поставляемую продукцию (по желанию клиента).
- Тестирование поставляемой продукции.
- Поставку компонентов, требующих военную и космическую приемку.
- Входной контроль качества.
- Наличие сертификата ISO.

В составе нашей компании организован Конструкторский отдел, призванный помогать разработчикам, и инженерам.

Конструкторский отдел помогает осуществить:

- Регистрацию проекта у производителя компонентов.
- Техническую поддержку проекта.
- Защиту от снятия компонента с производства.
- Оценку стоимости проекта по компонентам.
- Изготовление тестовой платы монтаж и пусконаладочные работы.



Тел: +7 (812) 336 43 04 (многоканальный)
Email: org@lifeelectronics.ru