

3-Year
Warranty

Series 2260B

Programmable DC Power Supplies

- 360W, 720W, and 1080W versions with voltages up to 800V and currents up to 108A
- Programmable voltage or current rise and fall times prevents damage to low impedance loads from inrush current
- Constant current priority setting reduces voltage and current overshoot when powering LEDs
- Programmable internal resistance simulates battery output
- Choose from analog control, USB, LAN, or optional GPIB interface for automated control
- Fit six 71mm wide 360W units or three 142mm wide 720W units or two 214mm wide 1080W units in a standard rack width to minimize bench and test system space



Source a wide range of voltages and currents with the 360W, 720W, or 1080W Series 2260B Programmable DC Power Supplies. Choose from 12 versions with voltage output of 30V, 80V, 250V or 800V. The 360W versions can output current of 36A, 13.5A, 4.5A, or 1.44A; the 720W models can output 72A, 27A, 9A, or 2.88A; and the 1080W instruments can output 108A, 40.5A, 13.5A or 4.32A. This wide range of output voltages and current, combined with multiple interface choices, makes the Series 2260B ideal for use in a wide range of applications, including research and design, quality control, and production test.

Control the Voltage or Current Rise Time to Reduce Inrush Current and Prevent Device Damage

Series 2260B power supplies have programmable rise time (or slew rate) control to prevent potentially dangerous inrush currents from flowing into loads that have low resistance when power is initially supplied. Either voltage or current rise time can be controlled. With voltage slew rate control, voltage rise time can range from a slow, 0.1V/s to a high speed of 1600V/s for the 800V supplies. When operating under constant current control, output current rise time can be programmed from a low slew rate of 0.001A/s to a maximum value of 216A/s for the Model 2260B-30-108. Programming a current rise time puts the Series 2260B power supplies in a constant current control priority mode in which the current slew rate limits the rate at which the voltage rises across the device under test (DUT). In addition to controlling rise time, fall time can also be programmed; fall time values can be different from rise time values. Delivery of power to a load can be precisely controlled to prevent overshoot spikes and excessive amounts of inrush current, eliminating damage to components, modules, or devices and generating more precise characteristic I-V curves for components such as LEDs.

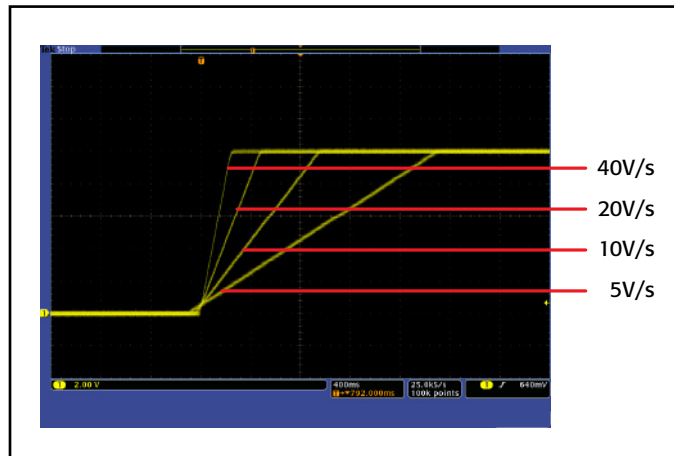

Precisely control voltage rise time with the variable slew rate control.

APPLICATIONS

- Environmental test, stress test, and accelerated life testing
- LED and high power component testing
- Automotive testing
- Battery research and test
- Production test

Programmable DC power supplies

DC POWER SUPPLIES

Series 2260B

Programmable DC Power Supplies

Ordering Information

- 2260B-30-36**
Programmable DC 360W
Power Supply, 30V, 36A
- 2260B-80-13**
Programmable DC 360W
Power Supply, 80V, 13.5A
- 2260B-250-4**
Programmable DC 360W
Power Supply, 250V, 4.5A
- 2260B-800-1**
Programmable DC 360W
Power Supply, 800V, 1.44A
- 2260B-30-72**
Programmable DC 720W
Power Supply, 30V, 72A
- 2260B-80-27**
Programmable DC 720W
Power Supply, 80V, 27A
- 2260B-250-9**
Programmable DC 720W
Power Supply, 250V, 9A
- 2260B-800-2**
Programmable DC 720W
Power Supply, 800V, 2.88A
- 2260B-30-108**
Programmable DC 1080W
Power Supply, 30V, 108A
- 2260B-80-40**
Programmable DC 1080W
Power Supply, 80V, 40.5A
- 2260B-250-13**
Programmable DC 1080W
Power Supply, 250V, 13.5A
- 2260B-800-4**
Programmable DC 1080W
Power Supply, 800V, 4.32A

Accessories Supplied

- 2260B Basic Accessory Kit
(for 36V and 80V models)
- 2260B-010 Basic Accessories
Kit (for 250V/800V Series)
- Quick Start Guide
- Documentation CD with Manuals
and Software Drivers
- Test Lead Set (for 36V
and 80V models)
- 2260-009 Test Lead (for
250V/800V models)
- USB Cable
- Power Cord
- Certificate of Traceable Calibration

Emulate the Response of a Battery

Test a circuit or device under the most realistic conditions by applying a test source with the output resistance that is equivalent to the output resistance of the actual source that will be used to power the circuit or device. For example, a battery has a varying internal resistance, and a device powered by a battery will have a voltage applied to the device that is reduced by the voltage drop across the battery's internal resistance. Versions of the Series 2260B power supplies can have an internal resistance up to 555Ω to simulate a wide range of battery chemistries and load conditions.

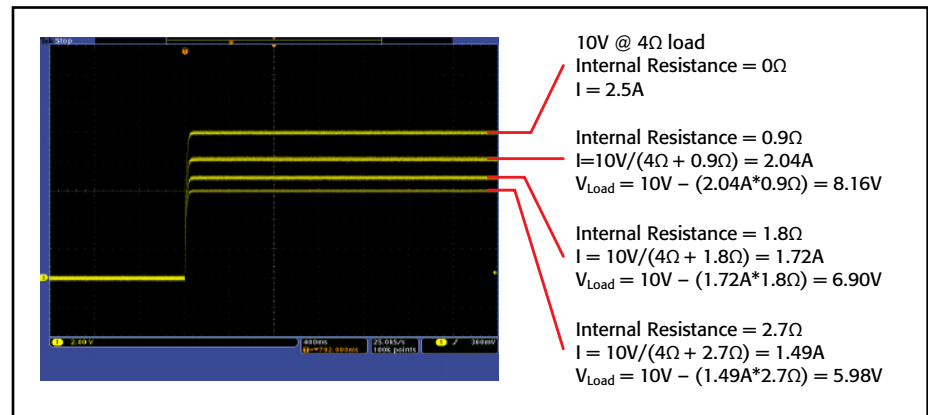

Use the programmable internal resistance to simulate a battery's output. In this example, a Model 2260B-80-13 power supply is simulating a 10V battery whose internal resistance is 0Ω, 0.9Ω, 1.8Ω, and 2.7Ω. The resulting voltage at the output terminals drops from 10V to 5.98V due to the voltage drop across the internal resistance of the battery.

Flexible and Fast for Automated Test Systems

With their USB, LAN, or optional GPIB interfaces, Series 2260B power supplies will work in any automated system. In addition, these power supplies have an analog control capability that can control outputs via an external voltage and resistance. Furthermore, Series 2260B power supplies feature fast discharge capability to quickly dissipate the voltage on the output. These power supplies also have a fast, 1ms transient recovery time to load changes. This combination of fast discharge time and fast transient response minimizes critical test time in automated test systems.

Series 2260B

Programmable DC Power Supplies

Create Custom Voltage Source Waveforms

An internal test sequence mode allows the Series 2260B supplies to output a set of voltage levels for varying time intervals at each level. The test sequence can be stored and used repeatedly to determine DUT performance at number of voltage levels. In addition, the analog input control can be used to create voltage profiles that simulate how a battery responds to a fast changing load current requirement such as a large inrush current. Also, generate a combined DC output level with an AC signal superimposed on it to test how a circuit responds to noise on its DC power source. The analog input control parameter can be either a voltage input or a resistance input. With this analog control capability, numerous types of DC supply signals can be generated to test circuits and devices under a wide range of circumstances.

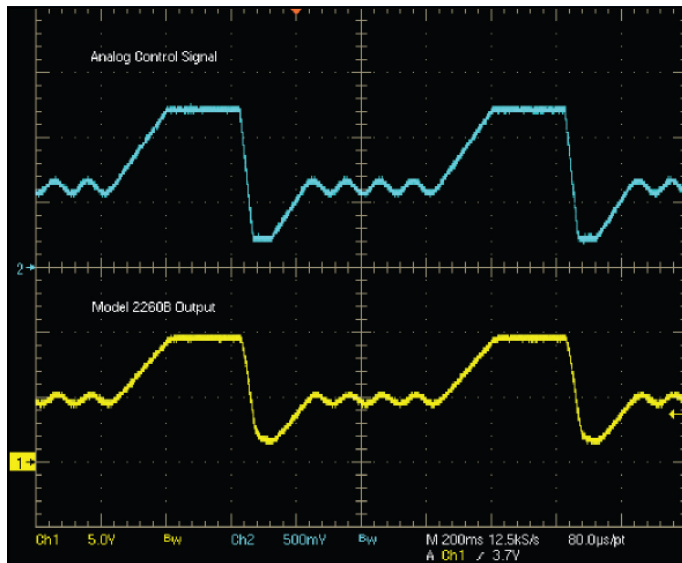

A signal generator (top plot) controls the 2260B to create a complex DC supply waveform (bottom plot) that simulates both a voltage drop due to a large inrush current and noise on the DC supply line.

ACCESSORIES AVAILABLE

2260-001	Accessory Kit
2260-002	Simple IDC Tool
2260-003	Contact Removal Tool
2260-004	Basic Accessories kit
2260-005	Cable for 2 units in Series connection
2260-006	Cable for 2 units in Parallel connection
2260-007	Cable for 3 units in Parallel connection
2260-008	Test Lead Set with Lugs
2260-009	Test Leads (250V, 800V models)
2260-010	Basic Accessories Kit (250V and 800V models)
2260B-EXTERM-HV	Extended Terminal (for 250V/800V HV models)
2260B-GPIB-USB	GPIB-to-USB Adapter
2260B-EXTERM	Extended Terminal
2260B-RMK-JIS	Rack Mount Kit (JIS racks)
2260B-RMK-EIA	Rack Mount Kit (EIA racks)
USB-B-1	USB Cable

SERVICES AVAILABLE

Model Number*-EW	3-year factory warranty extended to 1 additional year from date of shipment
Model Number*-5Y-EW	3-year factory warranty extended to 5 years from date of shipment
C/Model Number*-3Y-STD	KeithleyCare® 3 Year Standard Calibration Plan
C/Model Number*-3Y-DAT	KeithleyCare 3 Year Calibration with Data Plan
C/Model Number*-5Y-STD	KeithleyCare 5 Year Standard Calibration Plan
C/Model Number*-5Y-DAT	KeithleyCare 5 Year Calibration with Data Plan

* Replace the specific power supply model number in place of Model Number to generate the appropriate model number for a service item. For example, for Model 2260B-30-36, a 1-year extended warranty model number would be 2260B-30-36-1-EW.



Rear panel of 360W models.



Rear panel of 720W models.



Rear panel of 1080W models.

Series 2260B

Programmable DC Power Supplies

Specifications (23°C ±5°C)

	2260B-30-36	2260B-30-72	2260B-30-108	2260B-80-13	2260B-80-27	2260B-80-40	2260B-250-4	2260B-250-9	2260B-250-13	2260B-800-1	2260B-800-2	2260B-800-4
OUTPUT RATING												
Voltage	0–30 V	0–30 V	0–30 V	0–80 V	0–80 V	0–80 V	0–250 V	0–250 V	0–250 V	0–300 V	0–800 V	0–800 V
Current	0–36 A	0–72 A	0–108 A	0–13.5 A	0–27 A	0–40.5 A	0–4.5 A	0–9 A	0–13.5 A	0–1.44 A	0–2.88 A	0–4.32 A
Power	360 W	720 W	1080 W	360 W	720 W	1080 W	360 W	720 W	1080 W	360 W	720 W	1080 W
RIPPLE AND NOISE (Noise bandwidth 20 MHz, ripple bandwidth 1 MHz)												
CV p-p	60 mV	80 mV	100 mV	60 mV	80 mV	100 mV	80 mV	100 mV	120 mV	150 mV	200 mV	200 mV
CV rms	7 mV	11 mV	14 mV	7 mV	11 mV	14 mV	15 mV	15 mV	15 mV	30 mV	30 mV	30 mV
CC rms	72 mA	144 mA	216 mA	27 mA	54 mA	81 mA	10 mA	20 mA	30 mA	5 mA	10 mA	15 mA
PROGRAMMING ACCURACY												
Voltage	0.1% + 10 mV	0.1% + 10 mV	0.1% + 10 mV	0.1% + 10 mV	0.1% + 10 mV	0.1% + 10 mV	0.1% + 200 mV	0.1% + 200 mV	0.1% + 200 mV	0.1% + 400 mV	0.1% + 400 mV	0.1% + 400 mV
Current	0.1% + 30 mA	0.1% + 60 mA	0.1% + 100 mA	0.1% + 10 mA	0.1% + 30 mA	0.1% + 40 mA	0.1% + 5 mA	0.1% + 10 mA	0.1% + 15 mA	0.1% + 2 mA	0.1% + 4 mA	0.1% + 6 mA
READBACK ACCURACY												
Voltage	0.1% + 10 mV	0.1% + 10 mV	0.1% + 10 mV	0.1% + 10 mV	0.1% + 10 mV	0.1% + 10 mV	0.1% + 200 mV	0.1% + 200 mV	0.1% + 200 mV	0.1% + 400 mV	0.1% + 400 mV	0.1% + 400 mV
Current	0.1% + 30 mA	0.1% + 60 mA	0.1% + 100 mA	0.1% + 10 mA	0.1% + 30 mA	0.1% + 40 mA	0.1% + 5 mA	0.1% + 10 mA	0.1% + 15 mA	0.1% + 2 mA	0.1% + 4 mA	0.1% + 6 mA
RESPONSE TIME												
Rise Time	50 ms	50 ms	50 ms	50 ms	50 ms	50 ms	100 ms	100 ms	100 ms	150 ms	150 ms	150 ms
Fall Time (full load)	50 ms	50 ms	50 ms	50 ms	50 ms	50 ms	150 ms	150 ms	150 ms	300 ms	300 ms	300 ms
Fall Time (no load)	500 ms	500 ms	500 ms	500 ms	500 ms	500 ms	1200 ms	1200 ms	1200 ms	2000 ms	2000 ms	2000 ms
Load Transient Recovery Time (load change from 50 to 100%)	1 ms	1 ms	1 ms	1 ms	1 ms	1 ms	2 ms	2 ms	2 ms	2 ms	2 ms	2 ms
PROGRAMMING RESOLUTION (by PC Remote Control Mode)												
Voltage	1 mV	1 mV	1 mV	2 mV	2 mV	2 mV	5 mV	5 mV	5 mV	14 mV	14 mV	14 mV
Current	1 mA	2 mA	3 mA	1 mA	2 mA	3 mA	1 mA	1 mA	1 mA	1 mA	1 mA	1 mA
MEASUREMENT RESOLUTION (by PC Remote Control Mode)												
Voltage	1 mV	1 mV	1 mV	2 mV	2 mV	2 mV	5 mV	5 mV	5 mV	14 mV	14 mV	14 mV
Current	1 mA	2 mA	3 mA	1 mA	2 mA	3 mA	1 mA	1 mA	1 mA	1 mA	1 mA	1 mA
FRONT PANEL DISPLAY ACCURACY												
Voltage	0.1% ± 20 mV	0.1% ± 20 mV	0.1% ± 20 mV	0.1% ± 20 mV	0.1% ± 20 mV	0.1% ± 20 mV	0.1% ± 200 mV	0.1% ± 200 mV	0.1% ± 200 mV	0.1% ± 400 mV	0.1% ± 400 mV	0.1% ± 400 mV
Current	0.1% ± 40 mA	0.1% ± 70 mA	0.1% ± 100 mA	0.1% ± 20 mA	0.1% ± 40 mA	0.1% ± 50 mA	0.1% ± 5 mA	0.1% ± 10 mA	0.1% ± 20 mA	0.1% ± 2 mA	0.1% ± 4 mA	0.1% ± 6 mA

Series 2260B

Programmable DC Power Supplies

REGULATION (CV):

Load: 0.05% of setting + 5mV. Line: 0.05% of setting + 3mV.

REGULATION (CC):

Load: 0.1% of setting + 5mA. Line: 0.1% of setting + 5mA.

VOLTAGE SLEW RATE RANGE: Rising and Falling:

0.1V/s to 60V/s (2260B-30-36, 2260B-30-72, 260B-30-108).
0.1V/s to 160V/s (2260B-80-13, 2260B-80-27, 2260B-80-40).
0.1V/s to 60V/s (2260B-250-4, 2260B-250-9, 2260B-250-13).
1V/s to 1600V/s (2260B-800-1, 2260B-800-2, 2260B-800-4).

CURRENT SLEW RATE RANGE: Rising and Falling:

0.01 A/s to 72.00A/s (2260B-30-36).
0.1 A/s to 144.0A/s (2260B-30-72).
0.1 A/s to 216.0A/s (2260B-30-108).
0.01 A/s to 27.00A/s (2260B-80-13).
0.01 A/s to 54.00A/s (2260B-80-27).
0.01 A/s to 81.00A/s (2260B-80-40).
0.001A/s to 9.000A/s (2260B-250-4).
0.01 A/s to 18.00A/s (2260B-250-9).
0.01 A/s to 27.00A/s (2260B-250-13).
0.001A/s to 2.880A/s (2260B-800-1).
0.001A/s to 5.760A/s (2260B-800-2).
0.001A/s to 8.640A/s (2260B-800-4).

MAXIMUM VOLTAGE DROP IN EACH LOAD WIRE WHEN USING REMOTE SENSE:

30V and 80V Models: 0.6V.

250V and 800V Models: 1V.

OUTPUT DELAY TIME RANGE:

On Delay and Off Delay: 0s to 99.99s.

INTERNAL RESISTANCE RANGE:

0.000Ω to 0.833Ω (2260B-30-36).
0.000Ω to 0.417Ω (2260B-30-72).
0.000Ω to 5.926Ω (2260B-80-13).
0.000Ω to 2.963Ω (2260B-80-27).
0.000Ω to 0.278Ω (2260B-30-108).
0.000Ω to 1.975Ω (2260B-80-40).
0.00 Ω to 55.55Ω (2260B-250-4).
0.00 Ω to 27.77Ω (2260B-250-9).
0.00 Ω to 18.51Ω (2260B-250-13).
0.0 Ω to 555.5Ω (2260B-800-1).
0.0 Ω to 277.8Ω (2260B-800-2).
0.0 Ω to 185.4Ω (2260B-800-4).

SERIES AND PARALLEL CAPABILITY:

Parallel Operation: Up to 3 units including the master unit.

Series Operation: Up to 2 units including the master unit (30V and 80V models only).

PROTECTION FUNCTIONS:

OVP: 10% to 100% of rated output voltage range.

Accuracy: ±2% of rated output voltage.

OCP: ~10% to 110% of rated output current range.

Accuracy: ±2% of rated output current.

OTP: Activated by elevated internal temperatures.

ISOLATION VOLTAGE: 500VDC, output to chassis.

ANALOG VOLTAGE CONTROL:

Voltage Setting Accuracy: ±0.5% of rated output voltage.

Current Setting Accuracy: ±1% of rated output current.

ANALOG RESISTANCE CONTROL:

Voltage Setting Accuracy: ±1.5% of rated output voltage.

Current Setting Accuracy: ±1.5% of rated output current.

GENERAL

ANALOG CONTROL: External voltage or resistance control of output, voltage and current monitor outputs, turn-on, turn-off control, status monitoring, 26-Pin Connector (Rear Panel).

INTERFACE:

USB: 1.1/2.0, Type A Host (Front Panel), Type B Control (Rear Panel).

LAN: 100BASE-T (100Mb/s).

GPIB: (with optional 2260B-GPIB-USB Adapter).

AC INPUT RANGE: 85VAC-265VAC, 50/60Hz, single phase

MAXIMUM POWER CONSUMPTION:

500VA (2260B-30-36, 2260B-80-13, 2260B-250-4, 2260B-800-1).

1000VA (2260B-30-72, 2260B-80-27, 2260B-250-9, 2260B-800-2).

1500VA (2260B-30-108, 2260B-80-40, 2260B-250-13, 2260B-800-4).

POWER FACTOR: 0.97 to 0.99 (typical).

FAN: With thermal sensing control

ENVIRONMENT:

Operating: 0° to 50°C, 20% to 85% RH.

Storage: -25° to 70°C, 90% RH or less.

TEMPERATURE COEFFICIENT (after 30 minutes warm-up):

Voltage: 100ppm/°C.

Current: 200ppm/°C.

SAFETY: Complies with European Union Low Voltage Directive.

ELECTROMAGNETIC COMPATIBILITY: Complies with European Union EMC Directive.

DIMENSIONS, WEIGHT:

360W Models: 71mm wide × 124mm high × 350mm deep (2.80 in. × 4.88 in. × 13.78 in.).

Net Weight: Approx. 3kg (6.6 lb.).

Shipping Weight: 4.3kg (9.5 lb.).

720W Models: 142.5mm wide × 124mm high × 350mm deep (5.61 in. × 4.88 in. × 13.78 in.).

Net Weight: Approx. 5kg (11 lb.).

Shipping Weight: 6.8kg (15 lb.).

1080W Models: 214mm wide × 124mm high × 350mm deep (8.43 in. × 4.88 in. × 13.78 in.).

Net Weight: Approx 7.5kg (16.5 lb.).

Shipping Weight: 9.6kg (21 lb.)

WARRANTY: 3 years.

Series 2260B

Programmable DC Power Supplies

Series 2260B Accessories

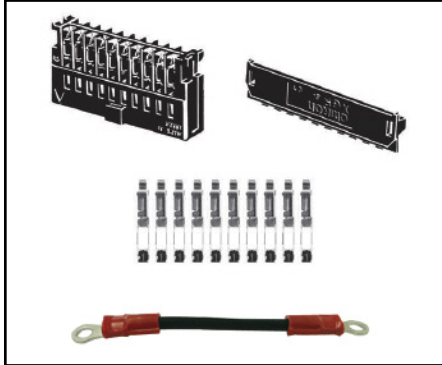

Model 2260-001: Accessory Kit: Analog control mating connector, pins, cover, and ground wire.



Model 2260-002: Simple IDC tool.

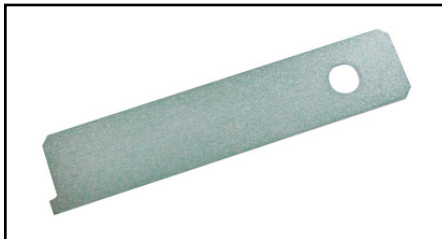

Model 2260-003: Contact removal tool.



Model 2260-008: Test lead set with lugs, 10AWG, 1.22m (48 in), red/blue wire pair with #10 terminal lugs on each end.



Model 2260-004: Accessory Kit (30V and 80V models): Air filter, analog connector cover, analog control lock lever, M8-size output terminal bolts, washers and screws, and M4-size output terminal screws with washers.

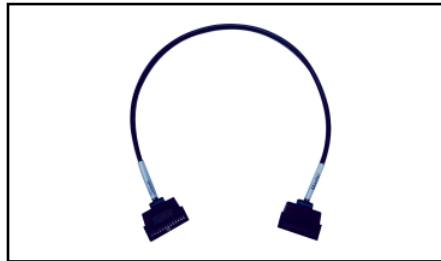

Model 2260-005: Cable, 0.5m (1.6 ft.), to connect two series 2260B power supplies in series.



Model 2260-006: Cable, 0.5m (1.6 ft.), to connect two series 2260B power supplies in parallel.

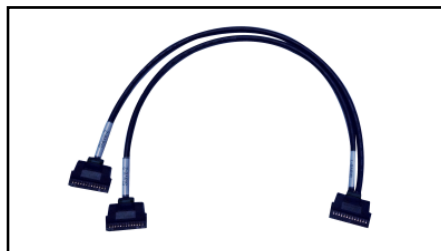

Model 2260-007: Cable, 0.5m (1.6 ft.), to connect three series 2260B power supplies in parallel.

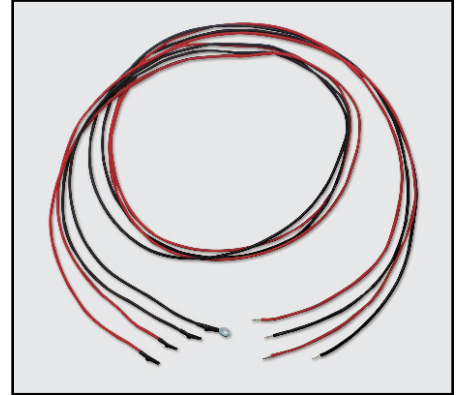

Model 2260-009: Test Lead Set for 250V and 800V models, two sets of red and black wires, 20AWG, 1.22m (48 in), stripped wires on one end and lugs on the other end.



Model 2260-010: Basic Accessories Kit (250V and 800V models): Air filter, analog protection cover, analog control lock lever, output terminal cover, output terminal connector, strain relief.



Model 2260B-EXTERM: Extended terminal; Test Leads, 0.7m (28 in.), and terminal box to bring outputs to the front of the instrument or another location. Magnetic base attaches to side of instrument.

Series 2260B

Programmable DC Power Supplies

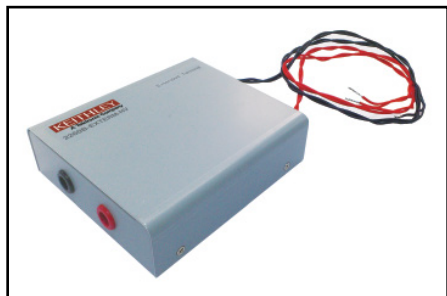

Model 2260B-EXTERM-HV: Extended terminal for 250V and 800V models; test leads and terminal box to bring outputs to the front of the instrument or another location. Magnetic base attached to side of instrument.



Model 2260B-GPIB-USB Adapter: Provides a GPIB interface for the Series 2260B power supplies.

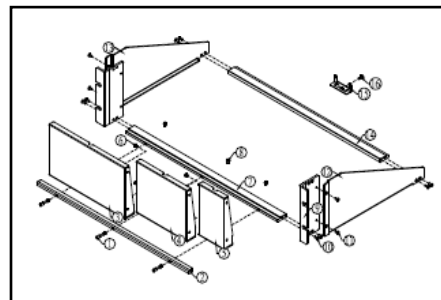

Model 2260B-RMK-EIA: Rack mount kit (EIA racks).

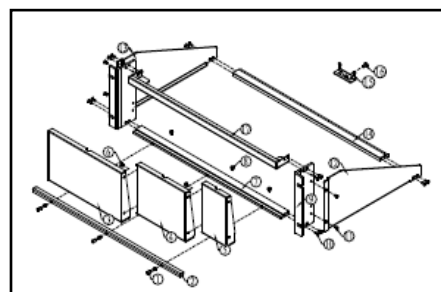

Model 2260B-RMK-JIS: Rack mount kit (JIS racks).

Contact Information:

ASEAN / Australia (65) 6356 3900
Austria 00800 2255 4835
Balkans, Israel, South Africa and other ISE Countries +41 52 675 3777
Belgium 00800 2255 4835
Brazil +55 (11) 3759 7627
Canada 1 800 833 9200
Central East Europe and the Baltics +41 52 675 3777
Central Europe & Greece +41 52 675 3777
Denmark +45 80 88 1401
Finland +41 52 675 3777
France 00800 2255 4835
Germany 00800 2255 4835
Hong Kong 400 820 5835
India 000 800 650 1835
Italy 00800 2255 4835
Japan 81 (3) 6714 3010
Luxembourg +41 52 675 3777
Mexico, Central/South America & Caribbean 52 (55) 56 04 50 90
Middle East, Asia, and North Africa +41 52 675 3777
The Netherlands 00800 2255 4835
Norway 800 16098
People's Republic of China 400 820 5835
Poland +41 52 675 3777
Portugal 80 08 12370
Republic of Korea 001 800 8255 2835
Russia & CIS +7 (495) 6647564
South Africa +41 52 675 3777
Spain 00800 2255 4835
Sweden 00800 2255 4835
Switzerland 00800 2255 4835
Taiwan 886 (2) 2656 6688
United Kingdom & Ireland 00800 2255 4835
USA 1 800 833 9200

Rev 0415

For Further Information

Tektronix maintains a comprehensive, constantly expanding collection of application notes, technical briefs and other resources to help engineers working on the cutting edge of technology. Visit www.tektronix.com or www.keithley.com.

Copyright © 2015, Tektronix. All rights reserved. Tektronix products are covered by U.S. and foreign patents, issued and pending. Information in this publication supersedes that in all previously published material. Specification and price change privileges reserved. TEKTRONIX and TEK are registered trademarks of Tektronix, Inc. All other trade names referenced are the service marks, trademarks or registered trademarks of their respective companies.

08.26.15 KI

1KW-60208-0

KEITHLEY
A Tektronix Company

Компания «Life Electronics» занимается поставками электронных компонентов импортного и отечественного производства от производителей и со складов крупных дистрибьюторов Европы, Америки и Азии.

С конца 2013 года компания активно расширяет линейку поставок компонентов по направлению коаксиальный кабель, кварцевые генераторы и конденсаторы (керамические, пленочные, электролитические), за счёт заключения дистрибьюторских договоров

Мы предлагаем:

- Конкурентоспособные цены и скидки постоянным клиентам.
- Специальные условия для постоянных клиентов.
- Подбор аналогов.
- Поставку компонентов в любых объемах, удовлетворяющих вашим потребностям.
- Приемлемые сроки поставки, возможна ускоренная поставка.
- Доставку товара в любую точку России и стран СНГ.
- Комплексную поставку.
- Работу по проектам и поставку образцов.
- Формирование склада под заказчика.
- Сертификаты соответствия на поставляемую продукцию (по желанию клиента).
- Тестирование поставляемой продукции.
- Поставку компонентов, требующих военную и космическую приемку.
- Входной контроль качества.
- Наличие сертификата ISO.

В составе нашей компании организован Конструкторский отдел, призванный помогать разработчикам, и инженерам.

Конструкторский отдел помогает осуществить:

- Регистрацию проекта у производителя компонентов.
- Техническую поддержку проекта.
- Защиту от снятия компонента с производства.
- Оценку стоимости проекта по компонентам.
- Изготовление тестовой платы монтаж и пусконаладочные работы.



Тел: +7 (812) 336 43 04 (многоканальный)

Email: org@lifeelectronics.ru