

FEATURES

- Single 16-bit DAC, 1 LSB INL
- Power-on reset to midscale or zero-scale
- Guaranteed monotonic by design
- 3 power-down functions
- Low power serial interface with Schmitt-triggered inputs
- Tiny 8-lead SOT-23 package, low power
- Fast settling time of 4 μ s typically
- 2.7 V to 5.5 V power supply
- Low glitch on power-up
- Unbuffered voltage capable of driving 60 k Ω load
- SYNC interrupt facility

APPLICATIONS

- Process control
- Data acquisition systems
- Portable battery-powered instruments
- Digital gain and offset adjustment
- Programmable voltage and current sources
- Programmable attenuators

GENERAL DESCRIPTION

The AD5062, a member of ADI's *nanoDAC* family, is a low power, single 16-bit unbuffered voltage-out DAC that operates from a single 2.7 V to 5.5 V supply. The part offers a relative accuracy specification of ± 1 LSB, and operation is guaranteed monotonic with a ± 1 LSB DNL specification. The part uses a versatile 3-wire serial interface that operates at clock rates up to 30 MHz, and is compatible with standard SPI[®], QSPI[™], MICROWIRE[™], and DSP interface standards. The reference for the AD5062 is supplied from an external V_{REF} pin. A reference buffer is also provided on-chip. The part incorporates a power-on reset circuit that ensures the DAC output powers up to zero scale or mid-scale and remains there until a valid write takes place to the device. The part contains a power-down feature that reduces the current consumption of the device to typically 300 nA at 5 V and provides software-selectable output loads while in power-down mode. The part is put into power-down mode over the serial interface. Total unadjusted error for the part is <0.8 mV.

This part exhibits very low glitch on power-up.

Rev. A

Information furnished by Analog Devices is believed to be accurate and reliable. However, no responsibility is assumed by Analog Devices for its use, nor for any infringements of patents or other rights of third parties that may result from its use. Specifications subject to change without notice. No license is granted by implication or otherwise under any patent or patent rights of Analog Devices. Trademarks and registered trademarks are the property of their respective owners.

FUNCTIONAL BLOCK DIAGRAM

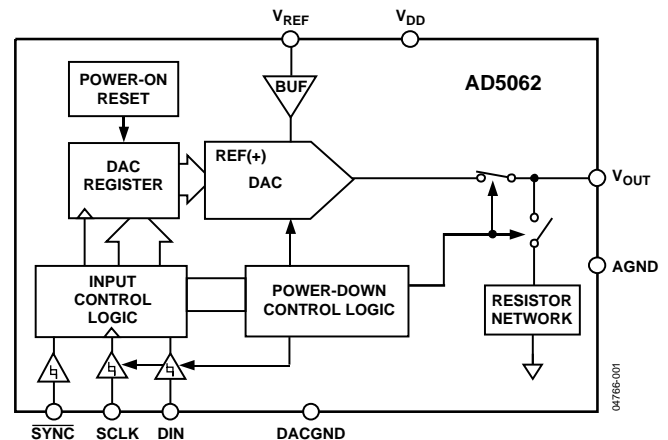

Figure 1.

Table 1. Related Devices

Part No.	Description
AD5061	2.7 V to 5.5 V, 16-bit <i>nanoDAC</i> D/A, 4 LSBs INL, SOT-23.
AD5063	2.7 V to 5.5 V, 16-bit <i>nanoDAC</i> D/A, 1 LSB INL, MSOP.
AD5040/AD5060	2.7 V to 5.5 V, 14-/16-bit <i>nanoDAC</i> D/A, 1 LSB INL, SOT-23.

PRODUCT HIGHLIGHTS

1. Available in a tiny 8-lead SOT-23 package.
2. 16-bit accurate, 1 LSB INL.
3. Low glitch on power-up.
4. High speed serial interface with clock speeds up to 30 MHz.
5. Three power-down modes available to the user.
6. Reset to known output voltage (zero-scale or mid-scale).

TABLE OF CONTENTS

Features	1	Reference Buffer	14
Applications.....	1	Serial Interface	14
Functional Block Diagram	1	Input Shift Register	14
General Description	1	$\overline{\text{SYNC}}$ Interrupt	14
Product Highlights	1	Power-On to Midscale or Zero Scale.....	15
Revision History	2	Software Reset.....	15
Specifications.....	3	Power-Down Modes	15
Timing Characteristics.....	5	Microprocessor Interfacing.....	15
Absolute Maximum Ratings.....	6	Applications.....	17
ESD Caution.....	6	Choosing a Reference for the AD5062.....	17
Pin Configuration and Function Descriptions.....	7	Bipolar Operation Using the AD5062.....	17
Typical Performance Characteristics	8	Using AD5062 with a Galvanically Isolated Interface Chip .	18
Terminology	13	Power Supply Bypassing and Grounding.....	18
Theory of Operation	14	Outline Dimensions	19
DAC Architecture.....	14	Ordering Guide	19

REVISION HISTORY

5/09—Rev. 0 to Rev. A

Changes to Figure 43..... 17

7/05—Revision 0: Initial Version

SPECIFICATIONS

$V_{DD} = 5.5\text{ V}$, $V_{REF} = 4.096\text{ V}$, $R_L = \text{Unloaded}$, $C_L = 22\text{ pF to GND}$; T_{MIN} to T_{MAX} , unless otherwise noted.

Table 2.

Parameter	A,B Grade ¹			Unit	Test Conditions/Comments
	Min	Typ	Max		
STATIC PERFORMANCE					
Resolution	16			Bits	
Relative Accuracy (INL) ²		±0.5	±1	LSB	−40°C to +85°C, B grade
		±0.5	±2		−40°C to +85°C, A grade
Total Unadjusted Error (TUE)		±500	±800	µV	−40°C to +85°C, B grade
		±500	±800		−40°C to +85°C, A grade
Differential Nonlinearity (DNL)		±0.5	±1	LSB	Guaranteed monotonic
		±0.5	±1		−40°C to +85°C, B grade
		±0.5	±1		Guaranteed monotonic
		±0.5	±1		−40°C to +85°C, A grade
Gain Error		±0.01	±0.02	% of FSR	$T_A = -40^\circ\text{C to } +85^\circ\text{C}$ B grade
		±0.01	±0.02		$T_A = -40^\circ\text{C to } +85^\circ\text{C}$ A grade
Gain Error Temperature Coefficient		1		ppm of FSR/°C	
Offset Error		±0.025	±0.05	mV	$T_A = -40^\circ\text{C to } +85^\circ\text{C}$, B grade
		±0.025	±0.05		$T_A = -40^\circ\text{C to } +85^\circ\text{C}$, A grade
Offset Error Temperature Coefficient		0.5		µV/°C	
Full-Scale Error		±500	±800	µV	All 1s loaded to DAC register, B grade
		±500	±800		$T_A = -40^\circ\text{C to } +85^\circ\text{C}$
		±500	±800		All 1s loaded to DAC register, A grade
		±500	±800		$T_A = -40^\circ\text{C to } +85^\circ\text{C}$
OUTPUT CHARACTERISTICS ³					
Output Voltage Range	0		V_{REF}	V	Unipolar operation
Output Voltage Settling Time		4		µs	¼ scale to ¾ scale code transition to ±1LSB.
Output Noise Spectral Density		24		nV/√Hz	DAC code = midscale, 1 kHz
Output Voltage Noise		6		µV p-p	DAC code = midscale, 0.1 to 10 Hz bandwidth
Digital-to-Analog Glitch Impulse		2		nV-s	1 LSB change around major carry
Digital Feedthrough		0.1		nV-s	
DC Output Impedance (Normal)		8		kΩ	Output impedance tolerance ±20%
DC Output Impedance (Power-Down)					
(Output Connected to 1 kΩ Network)		1		kΩ	Output impedance tolerance ±20%
(Output Connected to 100 kΩ Network)		100		kΩ	Output impedance tolerance ±20%
REFERENCE INPUT/ OUTPUT					
V_{REF} Input Range ²	2		$V_{DD} - 50$	mV	
Input Current (Power-Down)		±0.1		µA	Zero-scale loaded
Input Current (Normal)			±0.5	µA	
DC Input Impedance		1		MΩ	Bipolar/unipolar operation
LOGIC INPUTS					
Input Current ⁴		±1	±2	µA	
V_{IL} , Input Low Voltage			0.8	V	$V_{DD} = 4.5\text{ V to } 5.5\text{ V}$
			0.8		$V_{DD} = 2.7\text{ V to } 3.6\text{ V}$
V_{IH} , Input High Voltage	2.0			V	$V_{DD} = 2.7\text{ V to } 5.5\text{ V}$
	1.8				$V_{DD} = 2.7\text{ V to } 3.6\text{ V}$
Pin Capacitance		4		pF	

AD5062

Parameter	A,B Grade ¹			Unit	Test Conditions/Comments
	Min	Typ	Max		
POWER REQUIREMENTS					
V_{DD}	2.7		5.5	V	All digital inputs at 0 V or V_{DD}
I_{DD} (Normal Mode) $V_{DD} = 2.7\text{ V to }5.5\text{ V}$		0.65	0.7	mA	DAC active and excluding load current $V_{IN} = V_{DD}$ and $V_{IL} = \text{GND}$, $V_{DD} = 5.5\text{ V}$, $V_{REF} = 4.096\text{ V}$, code = midscale
I_{DD} (All Power-Down Modes) $V_{DD} = 2.5\text{ V to }5.5\text{ V}$			1	μA	$V_{IH} = V_{DD}$ and $V_{IL} = \text{GND}$, $V_{DD} = 5.5\text{ V}$, $V_{REF} = 4.096\text{ V}$, code = midscale
Power Supply Rejection Ratio (PSRR)		0.5		LSB	$\Delta V_{DD} \pm 10\%$, $V_{DD} = 5\text{ V}$, unloaded

¹ Temperature range for the B grade: -40°C to $+85^{\circ}\text{C}$, typical at 25°C ; temperature range for the Y grade: -40°C to $+125^{\circ}\text{C}$.

² Refer to Figure 27, Figure 28, Figure 29, Figure 30, and Figure 31 for device performance under lower supply and reference voltage conditions.

³ Guaranteed by design and characterization, not production tested.

⁴ Total current flowing into all pins.

TIMING CHARACTERISTICS

$V_{DD} = 2.7\text{ V to }5.5\text{ V}$; all specifications T_{MIN} to T_{MAX} , unless otherwise noted.

Table 3.

Parameter	Limit ¹	Unit	Test Conditions/Comments
t_1^2	33	ns min	SCLK cycle time
t_2	5	ns min	SCLK high time
t_3	3	ns min	SCLK low time
t_4	10	ns min	$\overline{\text{SYNC}}$ to SCLK falling edge setup time
t_5	3	ns min	Data setup time
t_6	2	ns min	Data hold time
t_7	0	ns min	SCLK falling edge to $\overline{\text{SYNC}}$ rising edge
t_8	12	ns min	Minimum $\overline{\text{SYNC}}$ high time
t_9	9	ns min	$\overline{\text{SYNC}}$ rising edge to next SCLK fall ignore

¹ All input signals are specified with $t_r = t_f = 1\text{ ns/V}$ (10% to 90% of V_{DD}) and timed from a voltage level of $(V_{IL} + V_{IH})/2$.

² Maximum SCLK frequency is 30 MHz.

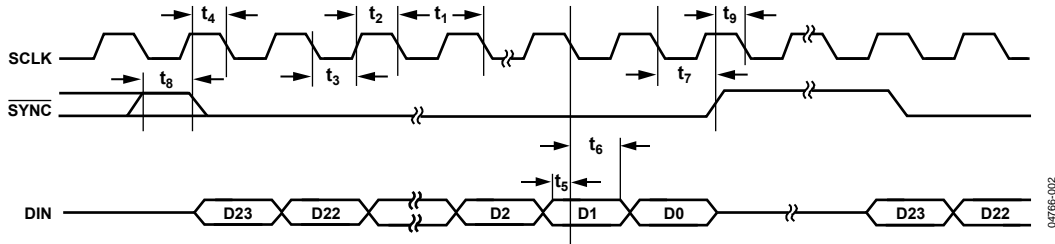

Figure 2. Timing Diagram

04786-002

ABSOLUTE MAXIMUM RATINGS

Table 4.

Parameter	Rating
V _{DD} to GND	−0.3 V to +7.0 V
Digital Input Voltage to GND	−0.3 V to V _{DD} + 0.3 V
V _{OUT} to GND	−0.3 V to V _{DD} + 0.3 V
V _{REF} to GND	−0.3 V to V _{DD} + 0.3 V
Operating Temperature Range	
Industrial (B grade)	−40°C to +85°C
Storage Temperature Range	−65°C to +150°C
Maximum Junction Temperature	150°C
SOT-23 Package	
Power Dissipation	$(T_J \text{ max} - T_A)/\theta_{JA}$
θ_{JA} Thermal Impedance	206°C/W
θ_{JC} Thermal Impedance	44°C/W
Reflow Soldering (Pb-free)	
Peak Temperature	260°C
Time-at-Peak Temperature	10 sec to 40 sec
ESD	1 kV

Stresses above those listed under Absolute Maximum Ratings may cause permanent damage to the device. This is a stress rating only and functional operation of the device at these or any other conditions above those indicated in the operational section of this specification is not implied. Exposure to absolute maximum rating conditions for extended periods may affect device reliability.

This device is a high performance integrated circuit with an ESD rating of <2 kV, and is ESD-sensitive. Proper precautions should be taken for handling and assembly.

ESD CAUTION

ESD (electrostatic discharge) sensitive device. Electrostatic charges as high as 4000V readily accumulate on the human body and test equipment and can discharge without detection. Although this product features proprietary ESD protection circuitry, permanent damage may occur on devices subjected to high energy electrostatic discharges. Therefore, proper ESD precautions are recommended to avoid performance degradation or loss of functionality.



PIN CONFIGURATION AND FUNCTION DESCRIPTIONS

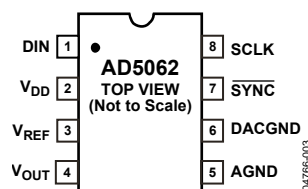

Figure 3.

Table 5. Pin Function Descriptions

Pin No.	Mnemonic	Description
1	DIN	Serial Data Input. This device has a 24-bit shift register. Data is clocked into the register on the falling edge of the serial clock input.
2	V _{DD}	Power Supply Input. These parts can be operated from 2.7 V to 5.5 V, and V _{DD} should be decoupled to GND.
3	V _{REF}	Reference Voltage Input.
4	V _{OUT}	Analog Output Voltage from DAC.
5	AGND	Ground Reference Point for Analog Circuitry.
6	DACGND	Ground Input to the DAC.
7	SYNC	Level-Triggered Control Input (Active Low). This is the frame synchronization signal for the input data. When SYNC goes low, it enables the input shift register, and data is transferred in on the falling edges of the following clocks. The DAC is updated following the 24th clock cycle unless SYNC is taken high before this edge, in which case the rising edge of SYNC acts as an interrupt, and the write sequence is ignored by the DAC.
8	SCLK	Serial Clock Input. Data is clocked into the input shift register on the falling edge of the serial clock input. Data can be transferred at rates up to 30 MHz.

TYPICAL PERFORMANCE CHARACTERISTICS

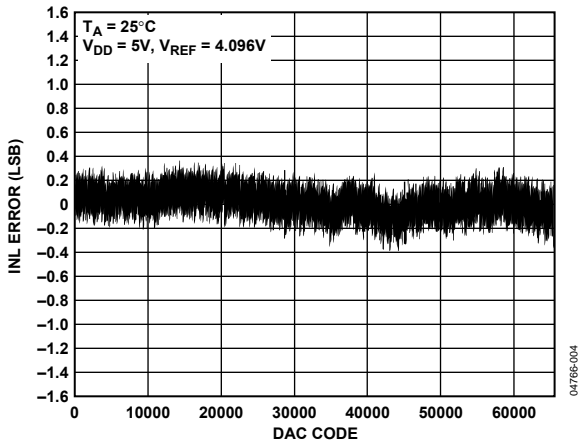

Figure 4. Typical INL Plot

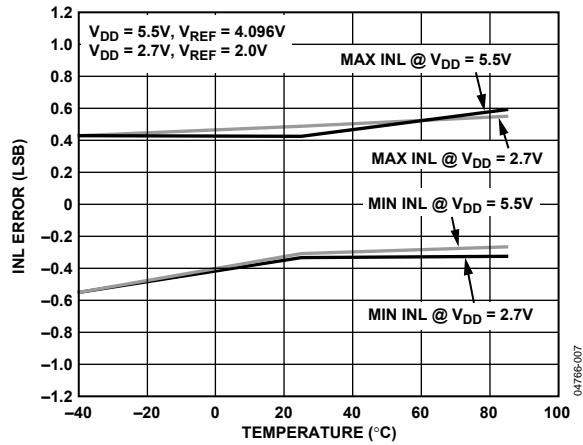

Figure 7. INL vs. Temperature

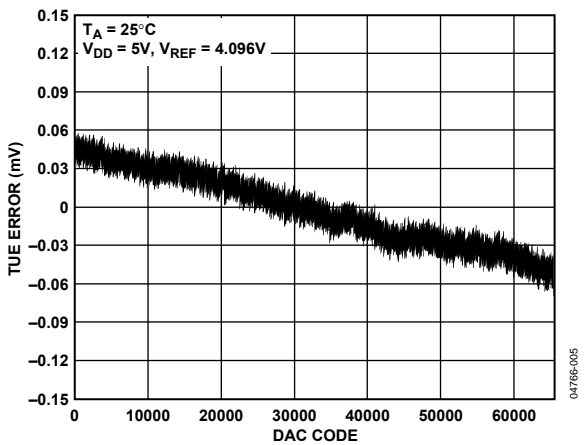

Figure 5. Typical TUE Plot

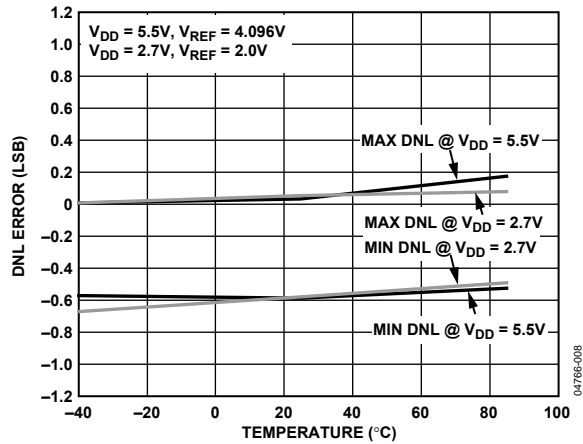

Figure 8. DNL vs. Temperature

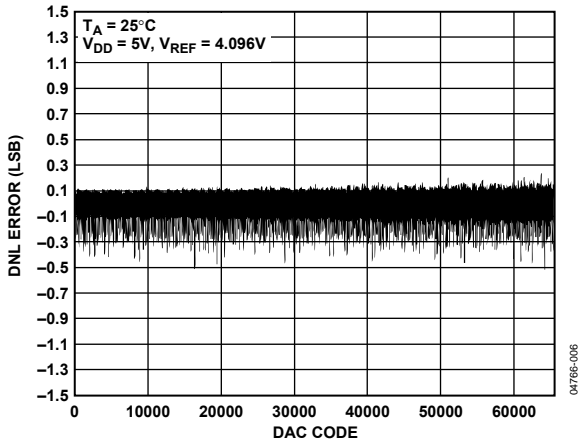

Figure 6. Typical DNL Plot

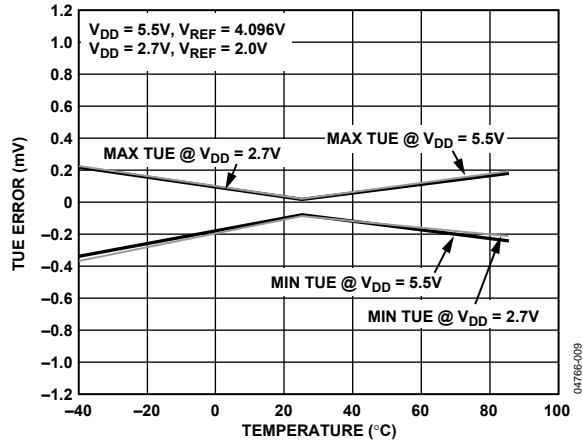

Figure 9. TUE vs. Temperature



Figure 10. INL vs. Reference Input Voltage



Figure 13. Offset vs. Temperature



Figure 11. DNL vs. Reference Input Voltage

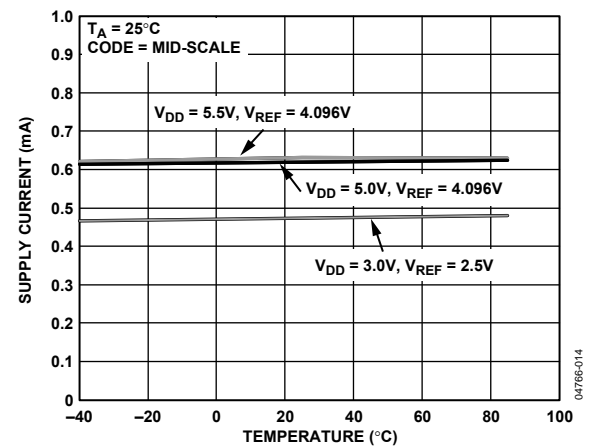

Figure 14. Supply Current vs. Temperature

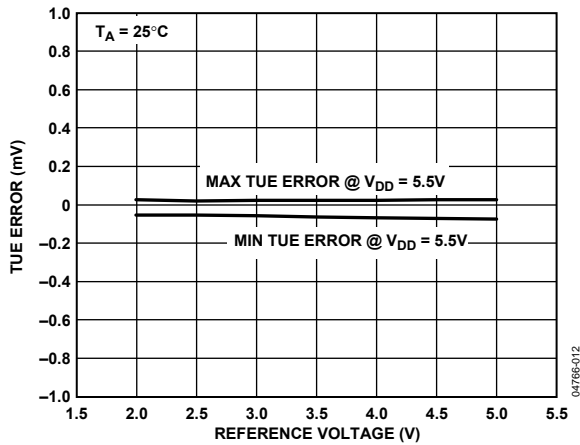

Figure 12. TUE vs. Reference Input Voltage

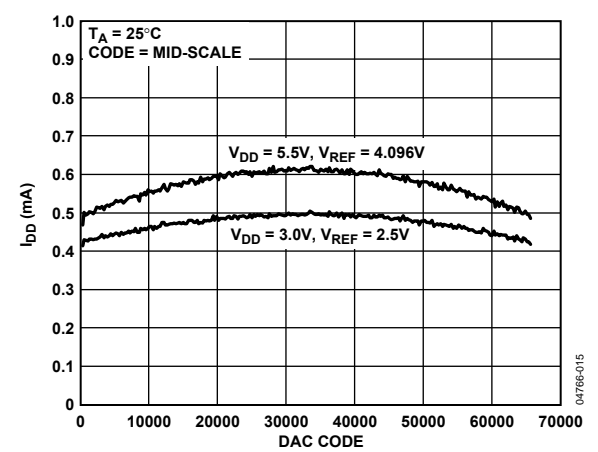

Figure 15. Supply Current vs. Digital Input Code

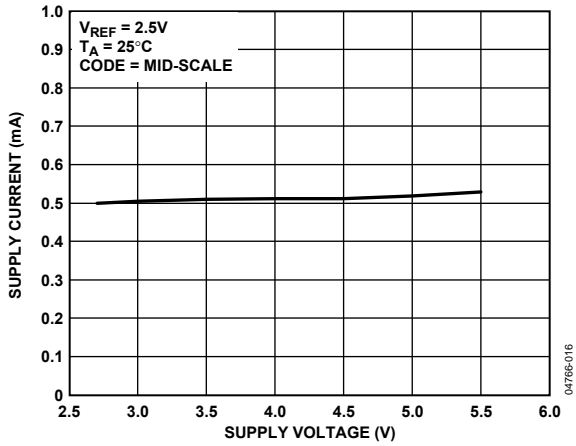

Figure 16. Supply Current vs. Supply Voltage

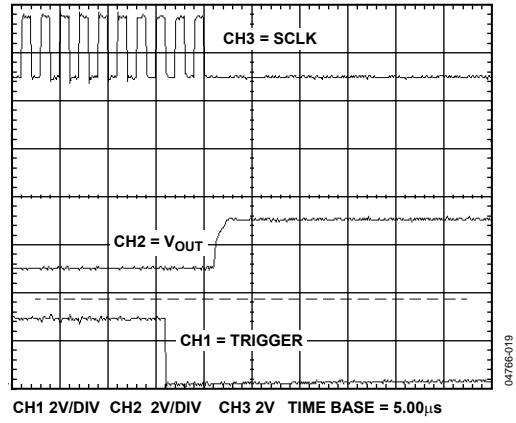

Figure 19. Exiting Power-Down @ $V_{DD}=3.0V$

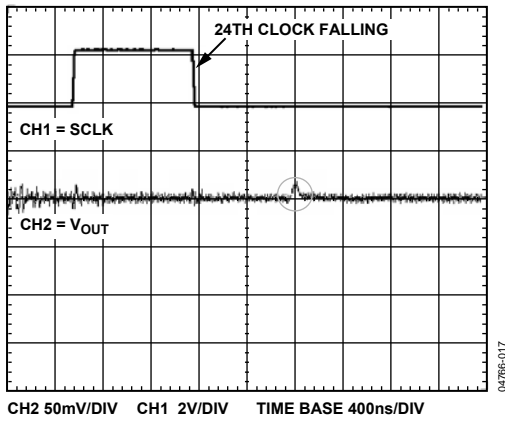

Figure 17. Digital-to-Analog Glitch Impulse; See Figure 21

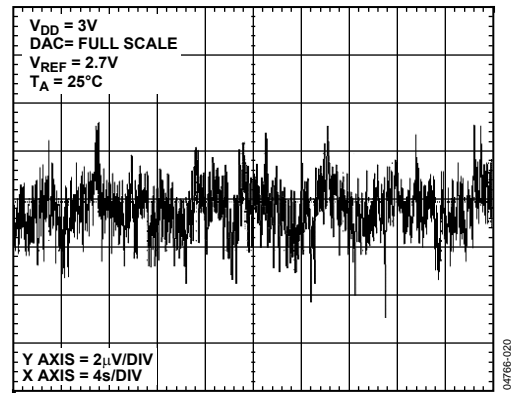

Figure 20. 0.1 Hz to 10 Hz Noise Plot

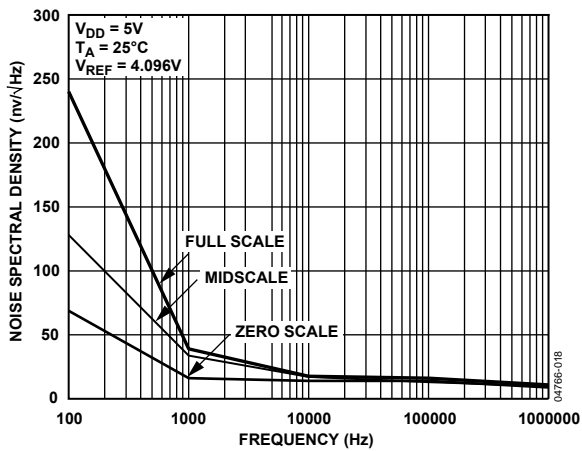

Figure 18. Output Noise Spectral Density

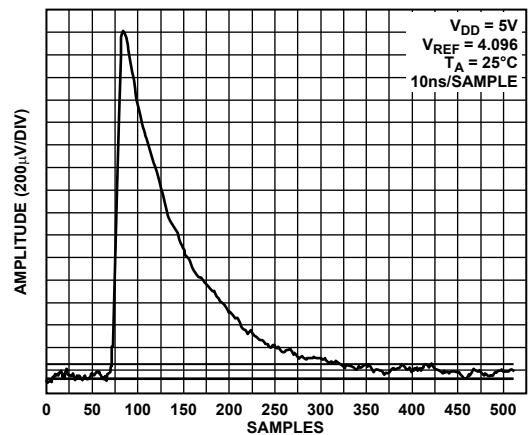

Figure 21. Glitch Energy

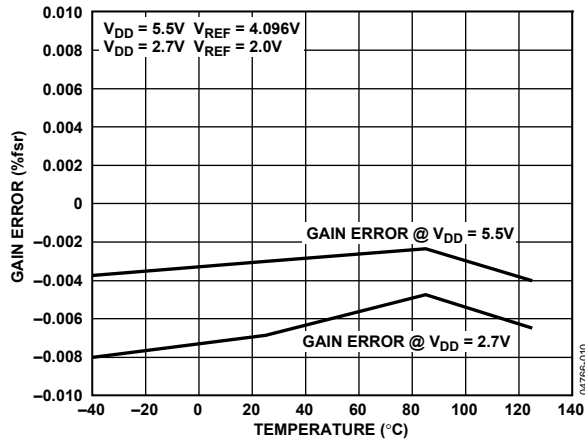

Figure 22. Gain Error vs. Temperature



Figure 25. Hardware Power-Down Glitch

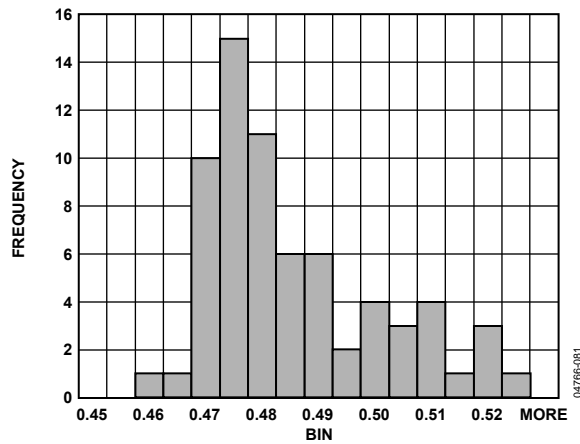

Figure 23. I_{DD} Histogram @ V_{DD} = 3 V

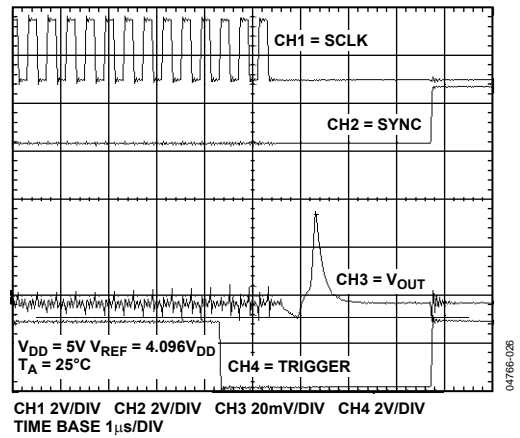

Figure 26. Exiting Software Power-Down Glitch

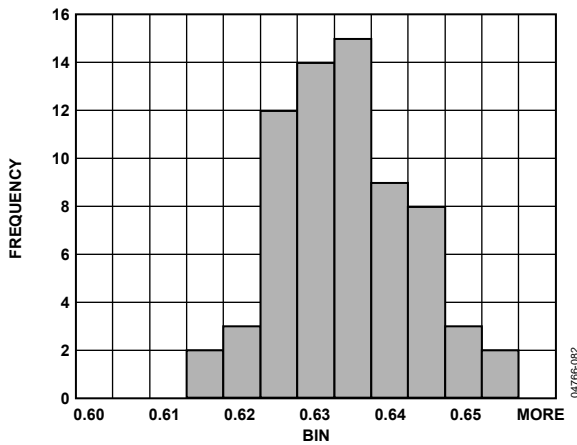

Figure 24. I_{DD} Histogram @ V_{DD} = 5 V

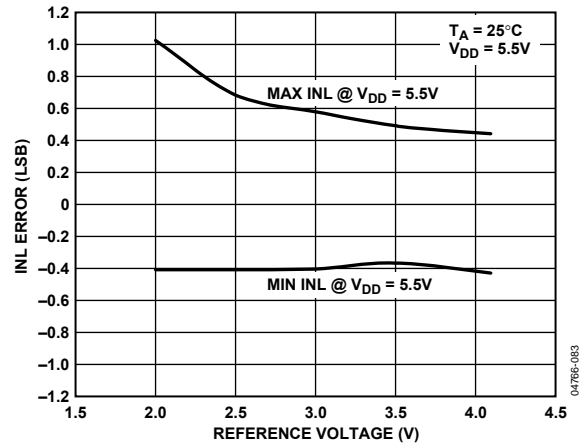

Figure 27. INL vs. V_{REF} @ V_{DD} = 5.5 V



Figure 28. INL vs. V_{REF} @ $V_{DD} = 5.0V$

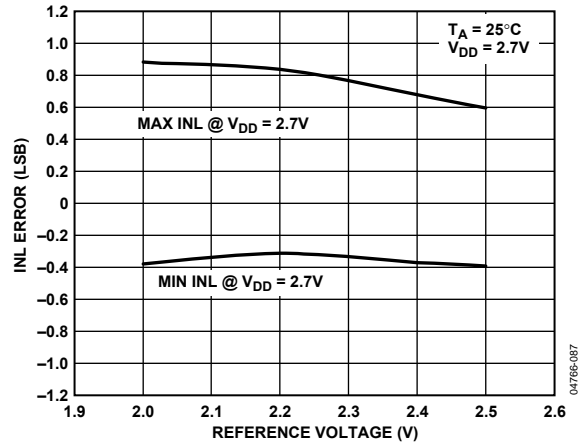

Figure 31. INL vs. V_{REF} @ $V_{DD} = 2.7V$



Figure 29. INL vs. V_{REF} @ $V_{DD} = 4.5V$

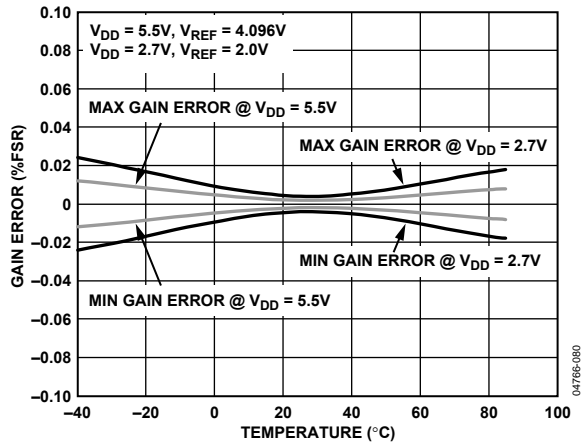

Figure 32. Gain Error vs. Temperature



Figure 30. INL vs. V_{REF} @ $V_{DD} = 3.5V$

TERMINOLOGY

Relative Accuracy

For the DAC, relative accuracy or integral nonlinearity (INL) is a measure of the maximum deviation, in LSBs, from a straight line passing through the endpoints of the DAC transfer function. A typical INL vs. code plot is shown in Figure 4.

Differential Nonlinearity (DNL)

Differential nonlinearity is the difference between the measured change and the ideal 1 LSB change between any two adjacent codes. A specified differential nonlinearity of ± 1 LSB maximum ensures monotonicity. This DAC is guaranteed monotonic by design. A typical DNL vs. code plot is shown in Figure 7.

Zero-Code Error

Zero-code error is a measure of the output error when zero code (0x0000) is loaded to the DAC register. Ideally, the output should be 0 V. The zero-code error is always positive in the AD5062 because the output of the DAC cannot go below 0 V. This is due to the offset errors in the DAC. Zero-code error is expressed in mV.

Full-Scale Error

Full-scale error is a measure of the output error when full-scale code (0xFFFF) is loaded to the DAC register. Ideally, the output should be $V_{DD} - 1$ LSB. Full-scale error is expressed in percent of full-scale range.

Gain Error

This is a measure of the span error of the DAC. It is the deviation in slope of the DAC transfer characteristic from ideal expressed as a percent of the full-scale range.

Total Unadjusted Error (TUE)

Total unadjusted error is a measure of the output error taking all the various errors into account. A typical TUE vs. code plot is shown in Figure 5.

Zero-Code Error Drift

This is a measure of the change in zero-code error with a change in temperature. It is expressed in $\mu\text{V}/^\circ\text{C}$.

Gain Error Drift

This is a measure of the change in gain error with changes in temperature. It is expressed in (ppm of full-scale range)/ $^\circ\text{C}$.

Digital-to-Analog Glitch Impulse

Digital-to-analog glitch impulse is the impulse injected into the analog output when the input code in the DAC register changes state. It is normally specified as the area of the glitch in nV-s and is measured when the digital input code is changed by 1 LSB at the major carry transition; see Figure 17 and Figure 21. The expanded view in Figure 17 shows the glitch generated following completion of the calibration routine; Figure 21 zooms in on this glitch.

Digital Feedthrough

Digital feedthrough is a measure of the impulse injected into the analog output of the DAC from the digital inputs of the DAC, but is measured when the DAC output is not updated. It is specified in nV-s and measured with a full-scale code change on the data bus; that is, from all 0s to all 1s, and vice versa.

THEORY OF OPERATION

The AD5062 is a single 16-bit, serial input, voltage output DAC. It operates from supply voltages of 2.7 V to 5.5 V. Data is written to the AD5062 in a 24-bit word format, via a 3-wire serial interface.

The AD5062 incorporates a power-on reset circuit that ensures the DAC output powers up to zero-scale or midscale. The device also has a software power-down mode pin that reduces the typical current consumption to less than 1 μ A.

DAC ARCHITECTURE

The DAC architecture of the AD5062 consists of two matched DAC sections. A simplified circuit diagram is shown in Figure 33. The four MSBs of the 16-bit data-word are decoded to drive 15 switches, E1 to E15. Each of these switches connects one of 15 matched resistors to either DACGND or V_{REF} buffer output. The remaining 12 bits of the data-word drive switches S0 to S11 of a 12-bit voltage mode R-2R ladder network.

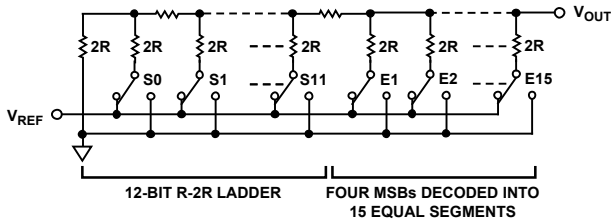

Figure 33. DAC Ladder Structure

REFERENCE BUFFER

The AD5062 operates with an external reference. The reference input (V_{REF}) has an input range of 2 V to $V_{DD} - 50$ mV. This input voltage is then used to provide a buffered reference for the DAC core.

SERIAL INTERFACE

The AD5062 has a 3-wire serial interface (\overline{SYNC} , SCLK, and DIN), which is compatible with SPI, QSPI, and MICROWIRE interface standards, as well as most DSPs. See Figure 2 for a timing diagram of a typical write sequence.

The write sequence begins by bringing the \overline{SYNC} line low. Data from the DIN line is clocked into the 24-bit shift register on the falling edge of SCLK. The serial clock frequency can be as high as 30 MHz, making these parts compatible with high speed DSPs. On the 24th falling clock edge, the last data bit is clocked in and the programmed function is executed (that is, a change in the DAC register contents and/or a change in the mode of operation).

At this stage, the \overline{SYNC} line may be kept low or be brought high. In either case, it must be brought high for a minimum of 33 ns before the next write sequence so that a falling edge of \overline{SYNC} can initiate the next write sequence. Because the \overline{SYNC} buffer draws more current when $V_{IN} = 1.8$ V than it does when $V_{IN} = 0.8$ V, \overline{SYNC} should be idled low between write sequences for even lower power operation of the part. As previously indicated, however, it must be brought high again just before the next write sequence.

INPUT SHIFT REGISTER

The input shift register is 24 bits wide; see Figure 34. PD1 and PD0 are control bits that control which mode of operation the part is in (normal mode or any one of three power-down modes). There is a more complete description of the various modes in the Power-Down Modes section. The next 16 bits are the data bits. These are transferred to the DAC register on the 24th falling edge of SCLK.

SYNC INTERRUPT

In a normal write sequence, the \overline{SYNC} line is kept low for at least 24 falling edges of SCLK and the DAC is updated on the 24th falling edge. However, if \overline{SYNC} is brought high before the 24th falling edge, this acts as an interrupt to the write sequence. The shift register is reset and the write sequence is seen as invalid. Neither an update of the DAC register contents nor a change in the operating mode occurs; see Figure 37.

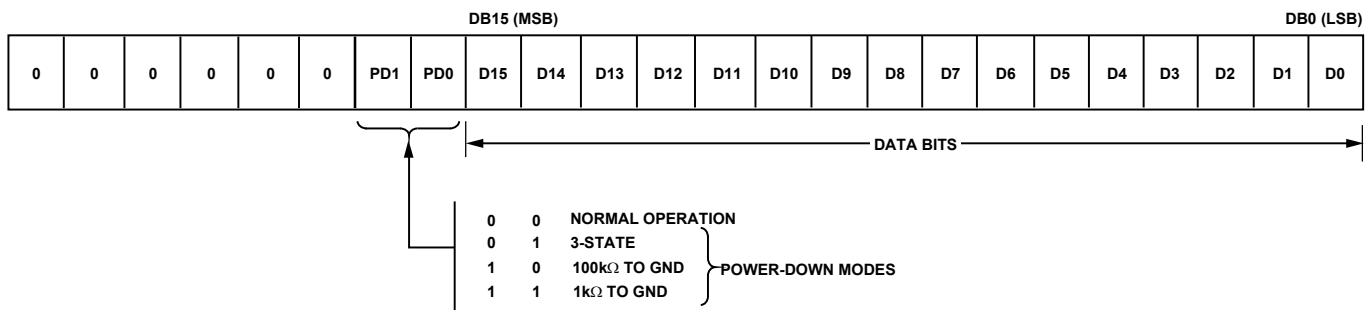

Figure 34. Input Register Contents

POWER-ON TO MIDSCALE OR ZERO SCALE

The AD5062 contains a power-on reset circuit that controls the output voltage during power-up. The DAC register is filled with the midscale code and the output voltage is midscale or the DAC register is filled with the zero-scale code and the output voltage is zero-scale. It remains there until a valid write sequence is made to the DAC. This is useful in applications where it is important to know the state of the output of the DAC while it is in the process of powering up.

SOFTWARE RESET

The device can be put into software reset by setting all bits in the DAC register to 1; this includes writing 1s to Bit D23 to Bit D16, which is not the normal mode of operation. Note that the SYNC interrupt command cannot be performed if a software reset command is started.

POWER-DOWN MODES

The AD5062 contains four separate modes of operation. These modes are software-programmable by setting two bits (DB17 and DB16) in the control register. Table 6 shows how the state of the bits corresponds to the mode of operation of the device.

Table 6. Modes of Operation for the AD5062

DB17	DB16	Operating Mode
0	0	Normal operation
		Power-down mode:
0	1	3-state
1	0	100 kΩ to GND
1	1	1 kΩ to GND

When both bits are set to 0, the part works normally with its normal power consumption. However, for the three power-down modes, the supply current falls to less than 1 μA at 5.5 V. Not only does the supply current fall, but the output stage is also internally switched from the output of the DAC to a resistor network of known values. This has the advantage that the output impedance of the part is known while the part is in power-down mode. There are three different options. The output is connected internally to GND through a 1 kΩ resistor or a 100 kΩ resistor, or it is left open-circuited (3-state). The output stage is illustrated in Figure 35.



Figure 35. Output Stage During Power-Down

The bias generator, the DAC core, and other associated linear circuitry are all shut down when the power-down mode is activated. However, the contents of the DAC register are unaffected when in power-down. The time to exit power-down is typically 2.5 μs for V_{DD} = 5 V, and 5 μs for V_{DD} = 3 V; see Figure 19.

MICROPROCESSOR INTERFACING

AD5062 to ADSP-2101/ADSP-2103 Interface

Figure 36 shows a serial interface between the AD5062 and the ADSP-2101/ADSP-2103. The ADSP-2101/ADSP-2103 should be set up to operate in the SPORT transmit alternate framing mode. The ADSP-2101/ADSP-2103 SPORT is programmed through the SPORT control register and should be configured as follows: internal clock operation, active low framing, 16-bit word length. Transmission is initiated by writing a word to the Tx register after the SPORT has been enabled.

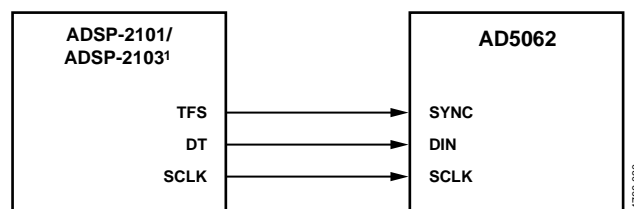

¹ADDITIONAL PINS OMITTED FOR CLARITY

Figure 36. AD5062 to ADSP-2101/ADSP-2103 Interface

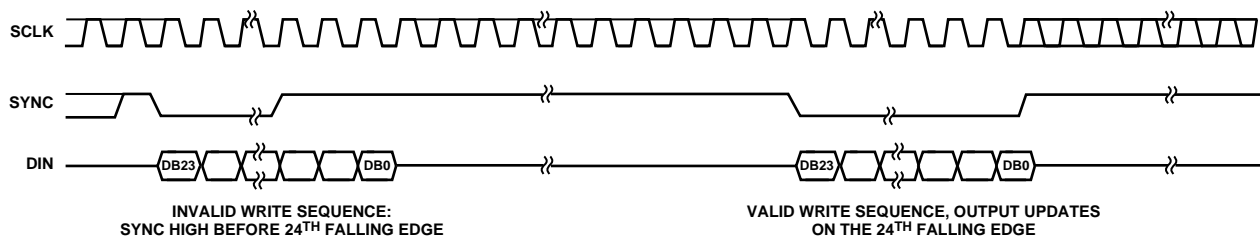

Figure 37. SYNC Interrupt Facility

AD5062

AD5062 to 68HC11/68L11 Interface

Figure 38 shows a serial interface between the AD5062 and the 68HC11/68L11 microcontroller. SCK of the 68HC11/68L11 drives the SCLK pin of the AD5062, while the MOSI output drives the serial data line of the DAC. The SYNC signal is derived from a port line (PC7). The setup conditions for correct operation of this interface require that the 68HC11/68L11 be configured so that its CPOL bit is 0 and its CPHA bit is 1. When data is being transmitted to the DAC, the SYNC line is taken low (PC7). When the 68HC11/68L11 is configured where its CPOL bit is 0 and its CPHA bit is 1, data appearing on the MOSI output is valid on the falling edge of SCK. Serial data from the 68HC11/68L11 is transmitted in 8-bit bytes with only eight falling clock edges occurring in the transmit cycle. Data is transmitted MSB first. In order to load data to the AD5062, PC7 is left low after the first eight bits are transferred, and a second serial write operation is performed to the DAC, and PC7 is taken high at the end of this procedure.



¹ADDITIONAL PINS OMITTED FOR CLARITY

Figure 38. AD5062 to 68HC11/68L11 Interface

AD5062 to Blackfin® ADSP-BF53x Interface

Figure 39 shows a serial interface between the AD5062 and the Blackfin ADSP-53x microprocessor. The ADSP-BF53x processor family incorporates two dual-channel synchronous serial ports, SPORT1 and SPORT0, for serial and multiprocessor communications. Using SPORT0 to connect to the AD5062, the setup for the interface is: DT0PRI drives the SDIN pin of the AD5062, while TSCLK0 drives the SCLK of the part; the SYNC is driven from TFS0.



¹ADDITIONAL PINS OMITTED FOR CLARITY

Figure 39. AD5062 to Blackfin ADSP-BF53x Interface

AD5062 to 80C51/80L51 Interface

Figure 40 shows a serial interface between the AD5062 and the 80C51/80L51 microcontroller. The setup for the interface is: TxD of the 80C51/80L51 drives SCLK of the AD5062 while RxD drives the serial data line of the part. The SYNC signal is again derived from a bit-programmable pin on the port. In this case, Port Line P3.3 is used. When data is to be transmitted to the AD5062, P3.3 is taken low. The 80C51/80L51 transmits data only in 8-bit bytes; thus only eight falling clock edges occur in the transmit cycle. To load data to the DAC, P3.3 is left low after the first eight bits are transmitted, and a second write cycle is initiated to transmit the second byte of data. P3.3 is taken high following the completion of this cycle. The 80C51/80L51 outputs the serial data in a format that has the LSB first. The AD5062 requires its data with the MSB as the first bit received; the 80C51/80L51 transmit routine should take this into account.

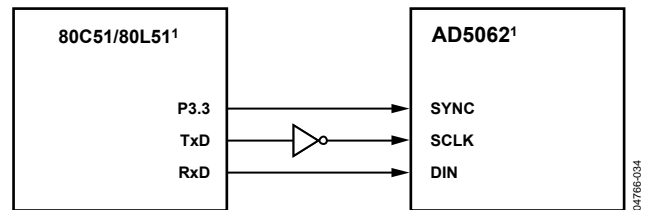

¹ADDITIONAL PINS OMITTED FOR CLARITY

Figure 40. AD5062 to 80C51/80L51 Interface

AD5062 to MICROWIRE Interface

Figure 41 shows an interface between the AD5062 and any MICROWIRE-compatible device. Serial data is shifted out on the falling edge of the serial clock and is clocked into the AD5062 on the rising edge of the SK.

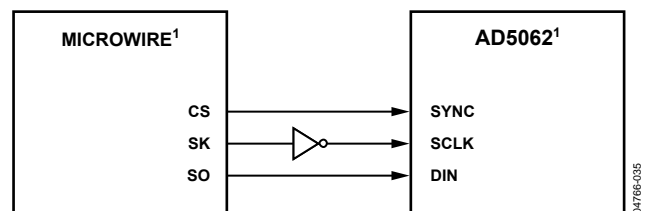

¹ADDITIONAL PINS OMITTED FOR CLARITY

Figure 41. AD5062 to MICROWIRE Interface

APPLICATIONS

CHOOSING A REFERENCE FOR THE AD5062

To achieve the optimum performance from the AD5062, thought should be given to the choice of a precision voltage reference. The AD5062 has just one reference input, V_{REF} . The voltage on the reference input is used to supply the positive input to the DAC. Therefore, any error in the reference is reflected in the DAC.

There are four possible sources of error when choosing a voltage reference for high accuracy applications: initial accuracy, ppm drift, long-term drift, and output voltage noise. Initial accuracy on the output voltage of the DAC will lead to a full-scale error in the DAC. To minimize these errors, a reference with high initial accuracy is preferred. Also, choosing a reference with an output trim adjustment, such as the ADR43x family, allows a system designer to trim out system errors by setting a reference voltage to a voltage other than the nominal. The trim adjustment can also be used at the operating temperature to trim out any error.

Because the supply current required by the AD5062 is extremely low, the parts are ideal for low supply applications. The ADR395 voltage reference is recommended. This requires less than 100 μ A of quiescent current and can, therefore, drive multiple DACs in one system, if required. It also provides very good noise performance at 8 μ V p-p in the 0.1 Hz to 10 Hz range.

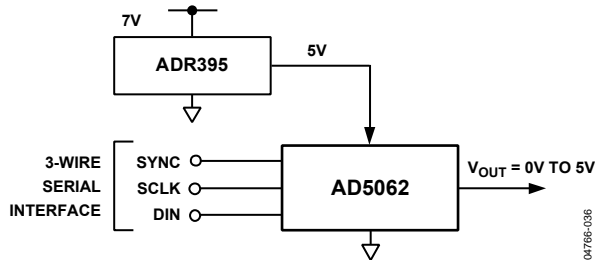

Figure 42. ADR395 as Reference to AD5062

Long-term drift is a measure of how much the reference drifts over time. A reference with a tight long-term drift specification ensures that the overall solution remains relatively stable during its entire lifetime. The temperature coefficient of a reference's output voltage affects INL, DNL, and TUE. A reference with a tight temperature coefficient specification should be chosen to reduce temperature dependence of the DAC output voltage on ambient conditions.

In high accuracy applications, which have a relatively low noise budget, reference output voltage noise needs to be considered. It is important to choose a reference with as low an output noise voltage as practical for the system noise resolution required. Precision voltage references, such as the ADR435, produce low output noise in the 0.1 Hz to 10 Hz region. Table 7 shows examples of recommended precision references for use as supply to the AD5062.

Table 7. Precision References Part List for the AD5062

Part No.	Initial Accuracy (mV max)	Temperature Drift (ppm/°C max)	0.1 Hz to 10 Hz Noise (μ V p-p typ)
ADR435	± 2	3 (SO-8)	8
ADR425	± 2	3 (SO-8)	3.4
ADR02	± 3	3 (SO-8)	10
ADR02	± 3	3 (SC70)	10
ADR395	± 5	9 (TSOT-23)	8

BIPOLAR OPERATION USING THE AD5062

The AD5062 has been designed for single-supply operation, but a bipolar output range is also possible using the circuit in Figure 43. The circuit shown yields an output voltage range of ± 5 V. Rail-to-rail operation at the amplifier output is achievable using an AD820/AD8032 or an OP196/OP295.

The output voltage for any input code can be calculated as follows:

$$V_o = \left[V_{DD} \times \left(\frac{D}{65536} \right) \times \left(\frac{R1 + R2}{R1} \right) - V_{DD} \times \left(\frac{R2}{R1} \right) \right]$$

where D represents the input code in decimal (0–65536).

With $V_{REF} = 5$ V, $R1 = R2 = 10$ k Ω :

$$V_o = \left(\frac{10 \times D}{65536} \right) - 5$$

This is an output voltage range of ± 5 V with 0x0000 corresponding to a -5 V output and 0xFFFF corresponding to a $+5$ V output.

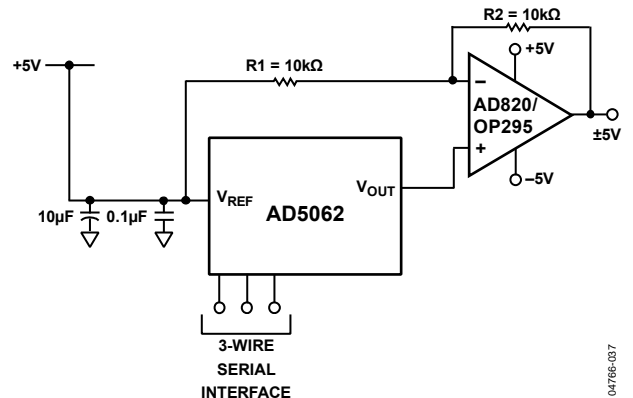

Figure 43. Bipolar Operation with the AD5062

AD5062

USING AD5062 WITH A GALVANICALLY ISOLATED INTERFACE CHIP

In process control applications in industrial environments, it is often necessary to use a galvanically isolated interface to protect and isolate the controlling circuitry from any hazardous common-mode voltages that may occur in the area where the DAC is functioning. *iCoupler*[®] provides isolation in excess of 2.5 kV. Because the AD5062 uses a 3-wire serial logic interface, the ADuM130x family provides an ideal digital solution for the DAC interface.

The ADuM130x isolators provide three independent isolation channels in a variety of channel configurations and data rates. They operate across the full range from 2.7 V to 5.5 V, providing compatibility with lower voltage systems as well as enabling a voltage translation functionality across the isolation barrier.

Figure 44 shows a typical galvanically isolated configuration using the AD5062. The power supply to the part also needs to be isolated; this is accomplished by using a transformer. On the DAC side of the transformer, a 5 V regulator provides the 5 V supply required for the AD5062.

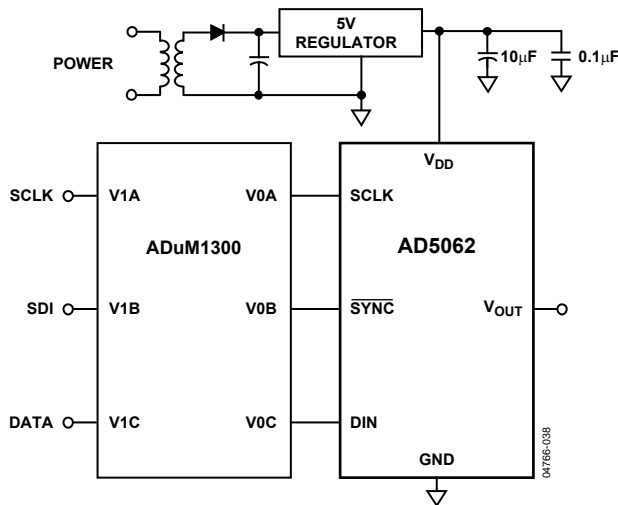

Figure 44. AD5062 with a Galvanically Isolated Interface

POWER SUPPLY BYPASSING AND GROUNDING

When accuracy is important in a circuit, it is helpful to carefully consider the power supply and ground return layout on the board. The printed circuit board containing the AD5062 should have separate analog and digital sections, each having its own area of the board. If the AD5062 is in a system where other devices require an AGND-to-DGND connection, the connection should be made at one point only. This ground point should be as close as possible to the AD5062.

The power supply to the AD5062 should be bypassed with 10 μ F and 0.1 μ F capacitors. The capacitors should be physically as close as possible to the device, with the 0.1 μ F capacitor ideally right up against the device. The 10 μ F capacitors are the tantalum bead type. It is important that the 0.1 μ F capacitor has low effective series resistance (ESR) and effective series inductance (ESI), as do common ceramic types of capacitors. This 0.1 μ F capacitor provides a low impedance path to ground for high frequencies caused by transient currents due to internal logic switching.

The power supply line itself should have as large a trace as possible to provide a low impedance path and reduce glitch effects on the supply line. Clocks and other fast switching digital signals should be shielded from other parts of the board by digital ground. Avoid crossover of digital and analog signals, if possible. When traces cross on opposite sides of the board, ensure that they run at right angles to each other to reduce feedthrough effects through the board. The best board layout technique is the microstrip technique where the component side of the board is dedicated to the ground plane only, and the signal traces are placed on the solder side. However, this is not always possible with a two-layer board.

OUTLINE DIMENSIONS

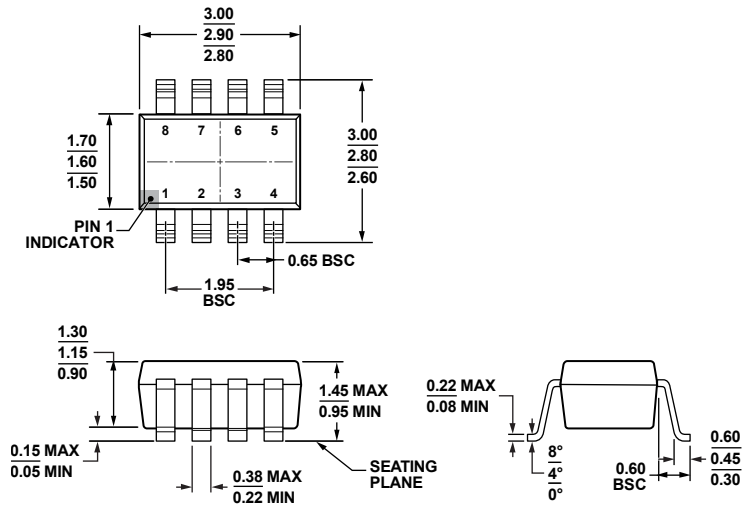

COMPLIANT TO JEDEC STANDARDS MO-178-BA
 Figure 45. 8-Lead Small Outline Transistor Package [SOT-23]
 (RJ-8)
 Dimensions shown in millimeters

121608-A

ORDERING GUIDE

Model	Temperature Range	INL	Description	Package Description	Package Options	Branding
AD5062BRJZ-1REEL7 ¹	-40°C to +85°C	1 LSB	2.7 V to 5.5 V, Reset to 0 V	8 Lead SOT-23	RJ-8	D46
AD5062BRJZ-1500RL7 ¹	-40°C to +85°C	1 LSB	2.7 V to 5.5 V, Reset to 0 V	8 Lead SOT-23	RJ-8	D46
AD5062BRJZ-2REEL7 ¹	-40°C to +85°C	1 LSB	2.7 V to 5.5 V, Reset to Midscale	8 Lead SOT-23	RJ-8	D47
AD5062BRJZ-2500RL7 ¹	-40°C to +85°C	1 LSB	2.7 V to 5.5 V, Reset to Midscale	8 Lead SOT-23	RJ-8	D47
AD5062ARJZ-1500RL7 ¹	-40°C to +85°C	2 LSB	2.7 V to 5.5 V, Reset to 0 V	8 Lead SOT-23	RJ-8	D48
AD5062ARJZ-1REEL7 ¹	-40°C to +85°C	2 LSB	2.7 V to 5.5 V, Reset to 0 V	8 Lead SOT-23	RJ-8	D48
EVAL AD5062EB				Evaluation Board		

¹ Z = RoHS Compliant Part.

AD5062

NOTES

Компания «Life Electronics» занимается поставками электронных компонентов импортного и отечественного производства от производителей и со складов крупных дистрибьюторов Европы, Америки и Азии.

С конца 2013 года компания активно расширяет линейку поставок компонентов по направлению коаксиальный кабель, кварцевые генераторы и конденсаторы (керамические, пленочные, электролитические), за счёт заключения дистрибьюторских договоров

Мы предлагаем:

- Конкурентоспособные цены и скидки постоянным клиентам.
- Специальные условия для постоянных клиентов.
- Подбор аналогов.
- Поставку компонентов в любых объемах, удовлетворяющих вашим потребностям.
- Приемлемые сроки поставки, возможна ускоренная поставка.
- Доставку товара в любую точку России и стран СНГ.
- Комплексную поставку.
- Работу по проектам и поставку образцов.
- Формирование склада под заказчика.
- Сертификаты соответствия на поставляемую продукцию (по желанию клиента).
- Тестирование поставляемой продукции.
- Поставку компонентов, требующих военную и космическую приемку.
- Входной контроль качества.
- Наличие сертификата ISO.

В составе нашей компании организован Конструкторский отдел, призванный помогать разработчикам, и инженерам.

Конструкторский отдел помогает осуществить:

- Регистрацию проекта у производителя компонентов.
- Техническую поддержку проекта.
- Защиту от снятия компонента с производства.
- Оценку стоимости проекта по компонентам.
- Изготовление тестовой платы монтаж и пусконаладочные работы.



Тел: +7 (812) 336 43 04 (многоканальный)
Email: org@lifeelectronics.ru