

BD675, BD675A, BD677, BD677A, BD679, BD679A, BD681

BD681 is a Preferred Device

Plastic Medium-Power Silicon NPN Darlingtons

This series of plastic, medium-power silicon NPN Darlington transistors can be used as output devices in complementary general-purpose amplifier applications.

Features

- High DC Current Gain:

$$h_{FE} = 750 \text{ (Min) @ } I_C$$

$$= 1.5 \text{ and } 2.0 \text{ Adc}$$
- Monolithic Construction
- BD675, 675A, 677, 677A, 679, 679A, 681 are complementary with BD676, 676A, 678, 678A, 680, 680A, 682
- BD677, 677A, 679, 679A are equivalent to MJE 800, 801, 802, 803
- Pb-Free Packages are Available*

MAXIMUM RATINGS

Rating	Symbol	Value	Unit
Collector-Emitter Voltage BD675, A BD677, A BD679, A BD681	V_{CEO}	45 60 80 100	Vdc
Collector-Base Voltage BD675, A BD677, A BD679, A BD681	V_{CBO}	45 60 80 100	Vdc
Emitter-Base Voltage	V_{EBO}	5.0	Vdc
Collector Current	I_C	4.0	Adc
Base Current	I_B	1.0	Adc
Total Device Dissipation @ $T_C = 25^\circ\text{C}$ Derate above 25°C	P_D	40 0.32	W W/°C
Operating and Storage Junction Temperature Range	T_J, T_{stg}	-55 to +150	°C

THERMAL CHARACTERISTICS

Characteristic	Symbol	Max	Unit
Thermal Resistance, Junction-to-Case	θ_{JC}	3.13	°C/W

Maximum ratings are those values beyond which device damage can occur. Maximum ratings applied to the device are individual stress limit values (not normal operating conditions) and are not valid simultaneously. If these limits are exceeded, device functional operation is not implied, damage may occur and reliability may be affected.

*For additional information on our Pb-Free strategy and soldering details, please download the ON Semiconductor Soldering and Mounting Techniques Reference Manual, SOLDERRM/D.



ON Semiconductor®

<http://onsemi.com>

**4.0 AMPERES
POWER TRANSISTORS
NPN SILICON
60, 80, 100 VOLTS, 40 WATTS**

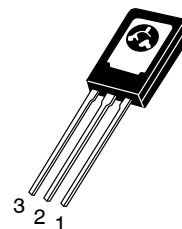
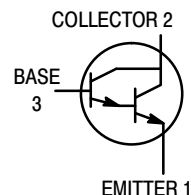

TO-225AA
CASE 77
STYLE 1

MARKING DIAGRAMS

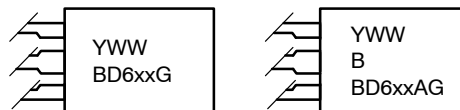

BD6xx = Device Code
 x = 75, 77, 79, 81
 Y = Year
 WW = Work Week
 G = Pb-Free Package

ORDERING INFORMATION

See detailed ordering and shipping information in the package dimensions section on page 4 of this data sheet.

Preferred devices are recommended choices for future use and best overall value.

BD675, BD675A, BD677, BD677A, BD679, BD679A, BD681

ELECTRICAL CHARACTERISTICS ($T_C = 25^\circ\text{C}$ unless otherwise noted)

Characteristic	Symbol	Min	Max	Unit	
OFF CHARACTERISTICS					
Collector-Emitter Breakdown Voltage, (Note 1) ($I_C = 50\text{ mAdc}$, $I_B = 0$)	BD675, 675A BD677, 677A BD679, 679A BD681	BV_{CEO}	45 60 80 100	- - - -	Vdc
Collector Cutoff Current ($V_{CE} = \text{Half Rated } BV_{CEO}$, $I_B = 0$)		I_{CEO}	-	500	μAdc
Collector Cutoff Current ($V_{CB} = \text{Rated } BV_{CEO}$, $I_E = 0$) ($V_{CB} = \text{Rated } BV_{CEO}$, $I_E = 0$, $T_C = 100^\circ\text{C}$)		I_{CBO}	- -	0.2 2.0	mAdc
Emitter Cutoff Current ($V_{BE} = 5.0\text{ Vdc}$, $I_C = 0$)		I_{EBO}	-	2.0	mAdc

ON CHARACTERISTICS

DC Current Gain, (Note 1) ($I_C = 1.5\text{ Adc}$, $V_{CE} = 3.0\text{ Vdc}$) ($I_C = 2.0\text{ Adc}$, $V_{CE} = 3.0\text{ Vdc}$)	BD675, 677, 679, 681 BD675A, 677A, 679A	h_{FE}	750 750	- -	-
Collector-Emitter Saturation Voltage, (Note 1) ($I_C = 1.5\text{ Adc}$, $I_B = 30\text{ mAdc}$) ($I_C = 2.0\text{ Adc}$, $I_B = 40\text{ mAdc}$)	BD677, 679, 681 BD675A, 677A, 679A	$V_{CE(sat)}$	- -	2.5 2.8	Vdc
Base-Emitter On Voltage, (Note 1) ($I_C = 1.5\text{ Adc}$, $V_{CE} = 3.0\text{ Vdc}$) ($I_C = 2.0\text{ Adc}$, $V_{CE} = 3.0\text{ Vdc}$)	BD677, 679, 681 BD675A, 677A, 679A	$V_{BE(on)}$	- -	2.5 2.5	Vdc

DYNAMIC CHARACTERISTICS

Small Signal Current Gain ($I_C = 1.5\text{ Adc}$, $V_{CE} = 3.0\text{ Vdc}$, $f = 1.0\text{ MHz}$)	h_{fe}	1.0	-	-
---	----------	-----	---	---

1. Pulse Test: Pulse Width $\leq 300\ \mu\text{s}$, Duty Cycle $\leq 2.0\%$.

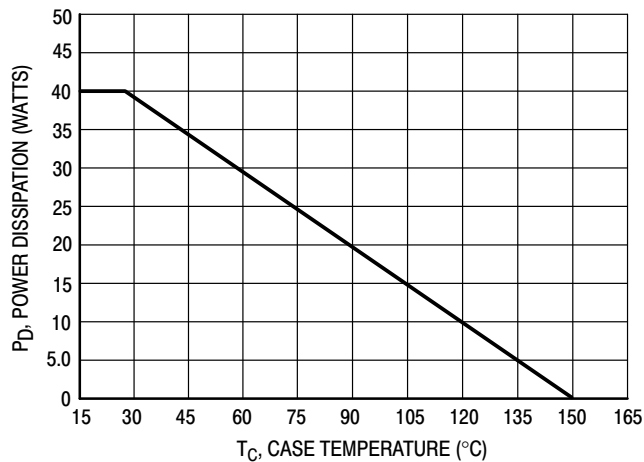

Figure 1. Power Temperature Derating

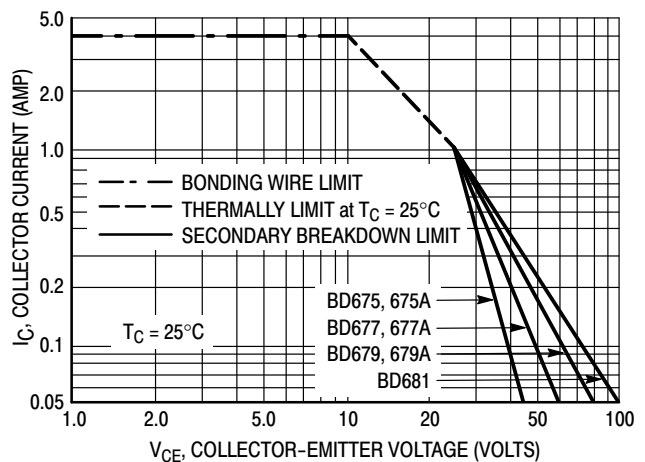

Figure 2. DC Safe Operating Area

There are two limitations on the power handling ability of a transistor average junction temperature and secondary breakdown. Safe operating area curves indicate $I_C - V_{CE}$ limits of the transistor that must be observed for reliable operation; e.g., the transistor must not be subjected to greater dissipation than the curves indicate.

At high case temperatures, thermal limitations will reduce the power that can be handled to values less than the limitations imposed by secondary breakdown.

BD675, BD675A, BD677, BD677A, BD679, BD679A, BD681

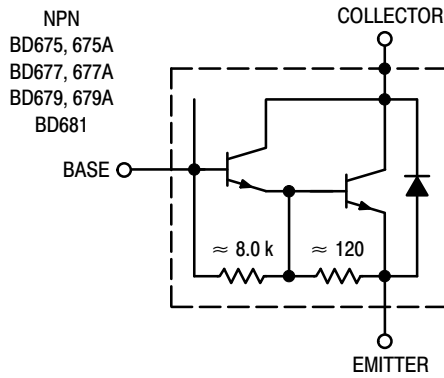

Figure 3. Darlington Circuit Schematic

ORDERING INFORMATION

Device	Package	Shipping
BD675	TO-225AA	500 Units / Box
BD675G	TO-225AA (Pb-Free)	500 Units / Box
BD675A	TO-225AA	500 Units / Box
BD675AG	TO-225AA (Pb-Free)	500 Units / Box
BD677	TO-225AA	500 Units / Box
BD677G	TO-225AA (Pb-Free)	500 Units / Box
BD677A	TO-225AA	500 Units / Box
BD677AG	TO-225AA (Pb-Free)	500 Units / Box
BD679	TO-225AA	500 Units / Box
BD679G	TO-225AA (Pb-Free)	500 Units / Box
BD679A	TO-225AA	500 Units / Box
BD679AG	TO-225AA (Pb-Free)	500 Units / Box
BD681	TO-225AA	500 Units / Box
BD681G	TO-225AA (Pb-Free)	500 Units / Box

BD675, BD675A, BD677, BD677A, BD679, BD679A, BD681

PACKAGE DIMENSIONS

TO-225AA
CASE 77-09
ISSUE Z

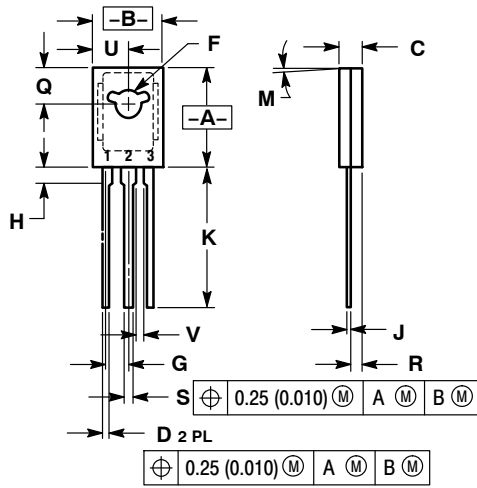

NOTES:

1. DIMENSIONING AND TOLERANCING PER ANSI Y14.5M, 1982.
2. CONTROLLING DIMENSION: INCH.
3. 077-01 THRU -08 OBSOLETE, NEW STANDARD 077-09.

DIM	INCHES		MILLIMETERS	
	MIN	MAX	MIN	MAX
A	0.425	0.435	10.80	11.04
B	0.295	0.305	7.50	7.74
C	0.095	0.105	2.42	2.66
D	0.020	0.026	0.51	0.66
F	0.115	0.130	2.93	3.30
G	0.094 BSC		2.39 BSC	
H	0.050	0.095	1.27	2.41
J	0.015	0.025	0.39	0.63
K	0.575	0.655	14.61	16.63
M	5° TYP		5° TYP	
Q	0.148	0.158	3.76	4.01
R	0.045	0.065	1.15	1.65
S	0.025	0.035	0.64	0.88
U	0.145	0.155	3.69	3.93
V	0.040	---	1.02	---

STYLE 1:

1. EMITTER
2. COLLECTOR
3. BASE

ON Semiconductor and are registered trademarks of Semiconductor Components Industries, LLC (SCILLC). SCILLC reserves the right to make changes without further notice to any products herein. SCILLC makes no warranty, representation or guarantee regarding the suitability of its products for any particular purpose, nor does SCILLC assume any liability arising out of the application or use of any product or circuit, and specifically disclaims any and all liability, including without limitation special, consequential or incidental damages. "Typical" parameters which may be provided in SCILLC data sheets and/or specifications can and do vary in different applications and actual performance may vary over time. All operating parameters, including "Typicals" must be validated for each customer application by customer's technical experts. SCILLC does not convey any license under its patent rights nor the rights of others. SCILLC products are not designed, intended, or authorized for use as components in systems intended for surgical implant into the body, or other applications intended to support or sustain life, or for any other application in which the failure of the SCILLC product could create a situation where personal injury or death may occur. Should Buyer purchase or use SCILLC products for any such unintended or unauthorized application, Buyer shall indemnify and hold SCILLC and its officers, employees, subsidiaries, affiliates, and distributors harmless against all claims, costs, damages, and expenses, and reasonable attorney fees arising out of, directly or indirectly, any claim of personal injury or death associated with such unintended or unauthorized use, even if such claim alleges that SCILLC was negligent regarding the design or manufacture of the part. SCILLC is an Equal Opportunity/Affirmative Action Employer. This literature is subject to all applicable copyright laws and is not for resale in any manner.

PUBLICATION ORDERING INFORMATION

LITERATURE FULFILLMENT:

Literature Distribution Center for ON Semiconductor
P.O. Box 5163, Denver, Colorado 80217 USA
Phone: 303-675-2175 or 800-344-3860 Toll Free USA/Canada
Fax: 303-675-2176 or 800-344-3867 Toll Free USA/Canada
Email: orderlit@onsemi.com

N. American Technical Support: 800-282-9855 Toll Free
USA/Canada
Europe, Middle East and Africa Technical Support:
Phone: 421 33 790 2910
Japan Customer Focus Center
Phone: 81-3-5773-3850

ON Semiconductor Website: www.onsemi.com

Order Literature: <http://www.onsemi.com/orderlit>

For additional information, please contact your local Sales Representative

Компания «Life Electronics» занимается поставками электронных компонентов импортного и отечественного производства от производителей и со складов крупных дистрибьюторов Европы, Америки и Азии.

С конца 2013 года компания активно расширяет линейку поставок компонентов по направлению коаксиальный кабель, кварцевые генераторы и конденсаторы (керамические, пленочные, электролитические), за счёт заключения дистрибьюторских договоров

Мы предлагаем:

- Конкурентоспособные цены и скидки постоянным клиентам.
- Специальные условия для постоянных клиентов.
- Подбор аналогов.
- Поставку компонентов в любых объемах, удовлетворяющих вашим потребностям.
- Приемлемые сроки поставки, возможна ускоренная поставка.
- Доставку товара в любую точку России и стран СНГ.
- Комплексную поставку.
- Работу по проектам и поставку образцов.
- Формирование склада под заказчика.
- Сертификаты соответствия на поставляемую продукцию (по желанию клиента).
- Тестирование поставляемой продукции.
- Поставку компонентов, требующих военную и космическую приемку.
- Входной контроль качества.
- Наличие сертификата ISO.

В составе нашей компании организован Конструкторский отдел, призванный помогать разработчикам, и инженерам.

Конструкторский отдел помогает осуществить:

- Регистрацию проекта у производителя компонентов.
- Техническую поддержку проекта.
- Защиту от снятия компонента с производства.
- Оценку стоимости проекта по компонентам.
- Изготовление тестовой платы монтаж и пусконаладочные работы.



Тел: +7 (812) 336 43 04 (многоканальный)
Email: org@lifeelectronics.ru