

BOARD LEVEL POWER SEMICONDUCTOR HEAT SINKS

217 SERIES Surface Mount Heat Sinks

D²PAK, TO-220, SOT-223, SOL-20

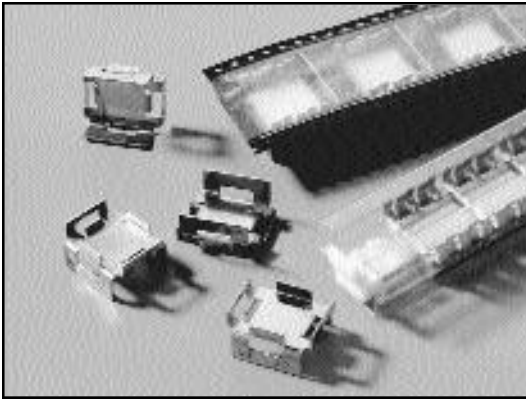

Compatible with surface mount technology (SMT) automated production techniques for ease of assembly and a variety of soldering methods, these heat sinks allow greater packaging densities and reduction in PC-board area, increasing the power dissipation of surface mount devices (SMDs) while maintaining and improving manufacturers' component thermal specifications.

FEATURES AND BENEFITS:

- No interface material is needed
- Copper with tin-lead plating for improved solderability and assembly
- Both the component and the heat sink are installed on the PC-board utilizing standard SMT assembly equipment for "Tape & Reel" and "Tube" formats
- EIA standards and ESD protection are specified
- Can be used with water soluble or no clean SMT solder creams or other pastes

| Standard P/N | Height Above PC Board in. (mm) | Footprint Dimensions in. (mm) | Package Format | Package Quantity | Thermal Performance at Typical Load | |
|--------------|--------------------------------|-------------------------------|----------------|------------------|-------------------------------------|--------------------|
| | | | | | Natural Convection | Forced Convection |
| 217-36CT6 ▲ | .390 (9.9) | .600 (15.2) x .740 (18.8) | Bulk | 1 | 55°C @ 1W | 16.0°C/W @ 200 LFM |
| 217-36CTT6 | .390 (9.9) | .600 (15.2) x .740 (18.8) | Tube | 20 | 55°C @ 1W | 16.0°C/W @ 200 LFM |
| 217-36CTR6▲ | .390 (9.9) | .600 (15.2) x .740 (18.8) | Tape & Reel | 250 | 55°C @ 1W | 16.0°C/W @ 200 LFM |

Material: Copper, Tin, Lead Plated

MECHANICAL DIMENSIONS

217 HEAT SINK WITH DDPAK DEVICE

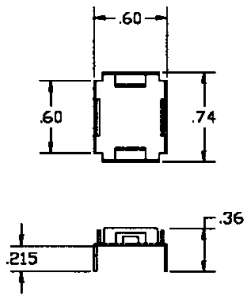

217-36CT6

THERMAL PERFORMANCE 6 LAYER BOARD, D²PAK 125°C LEAD, 40°C AMBIENT

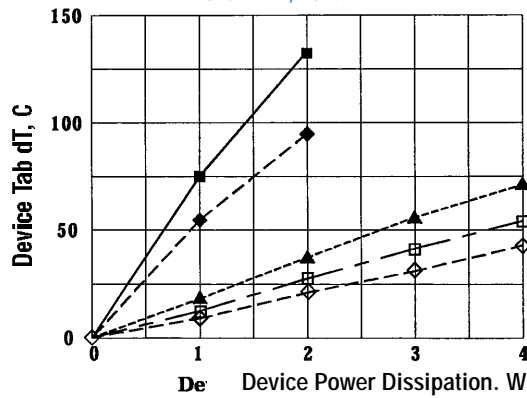

KEY: ■ Device only, NC ◆ Device + HS, NC ▲ Device + HS, 100 lfm □ Device + HS, 200 lfm ◇ Device + HS, 300 lfm

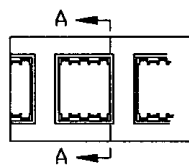

SECTION A-A

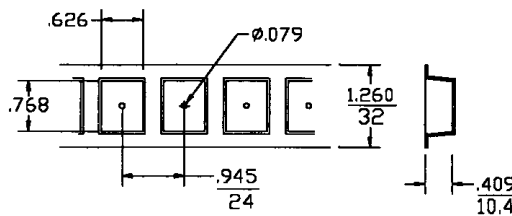

TAPE DETAILS



REEL DETAILS

- NOTES
1. Material to be "ESD"
 2. Approximately 6 Meters per Reel
 3. 250 Pieces per Reel.

217-36CTR6

Dimensions: in.

BOARD LEVEL POWER SEMICONDUCTOR HEAT SINKS



PATENT PENDING

233 AND 236 SERIES Self-Locking Wavesolderable Heat Sinks

TO-220

| Standard P/N | Height Above PC Board in. (mm) | Footprint Dimensions in. (mm) | Mounting Configuration | Solderable Tab Options | Mounting Style | Thermal Performance at Typical Load | |
|----------------|--------------------------------|-------------------------------|------------------------|------------------------|----------------|-------------------------------------|--------------------|
| | | | | | | Natural Convection | Forced Convection |
| 233-60AB ▲ | .600 (15.2) | .570 (14.5) x .500 (12.7) | Vert./Horiz. | No Tab | Clip/Mtg Hole | 58°C @ 2W | 11.0°C/W @ 400 LFM |
| 233-60AB-01 | .600 (15.2) | .570 (14.5) x .500 (12.7) | Vertical | 01 | Clip/Mtg Hole | 58°C @ 2W | 11.0°C/W @ 400 LFM |
| 233-60AB-05 | .500 (12.7) | .600 (15.2) x .570 (14.5) | Horizontal | 05 | Clip/Mtg Hole | 58°C @ 2W | 11.0°C/W @ 400 LFM |
| 233-60AB-10 ▲ | .725 (18.4) | .570 (14.5) x .500 (12.7) | Vertical | 10 | Clip/Mtg Hole | 58°C @ 2W | 11.0°C/W @ 400 LFM |
| 236-150AB | 1.500 (38.1) | .570 (14.5) x .500 (12.7) | Vert./Horiz. | No Tab | Clip/Mtg Hole | 58°C @ 2W | 4.80°C/W @ 400 LFM |
| 236-150AB-01 | 1.500 (38.1) | .570 (14.5) x .500 (12.7) | Vertical | 01 | Clip/Mtg Hole | 58°C @ 2W | 4.80°C/W @ 400 LFM |
| 236-150AB-05 ▲ | .500 (12.7) | 1.500 (38.1) x .570 (14.5) | Horizontal | 05 | Clip/Mtg Hole | 58°C @ 2W | 4.80°C/W @ 400 LFM |
| 236-150AB-10 | 1.625 (41.3) | .570 (14.5) x .570 (12.7) | Vertical | 10 | Clip/Mtg Hole | 58°C @ 2W | 4.80°C/W @ 400 LFM |

Material: Aluminum, Black Anodized

MECHANICAL DIMENSIONS 233 AND 236 SERIES

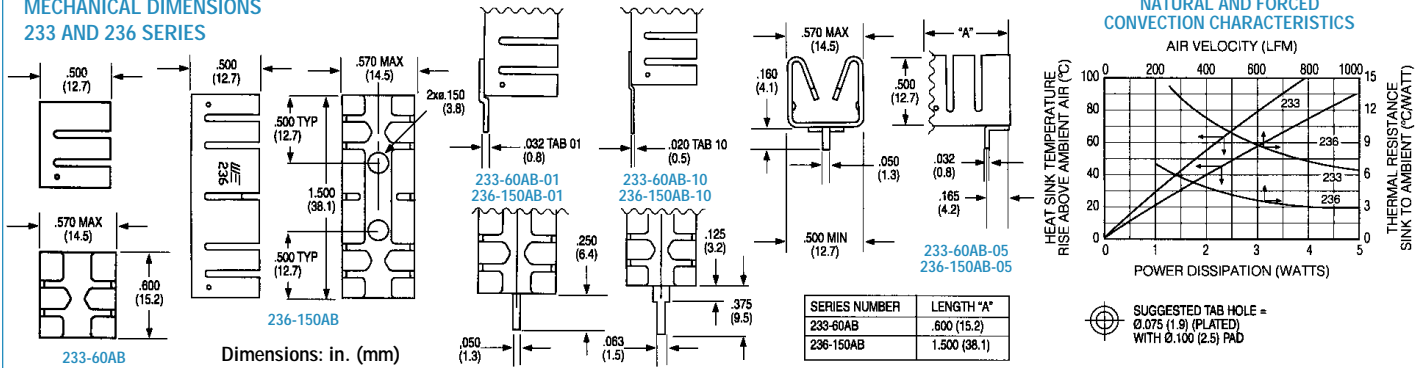

PATENT 5381041

275 AND 231 SERIES Compact, Stress-Free Labor-Saving Locking-Tab Heat Sinks

TO-220

| Standard P/N | Height Above PC Board in. (mm) | Footprint Dimensions in. (mm) | Mounting Configuration | Solderable Tab Options | Mounting Style | Thermal Performance at Typical Load | |
|------------------------|--------------------------------|-------------------------------|------------------------|------------------------|----------------|-------------------------------------|-------------------|
| | | | | | | Natural Convection | Forced Convection |
| 275-75AB | .750 (19.1) | .835 (21.2) x .400 (10.2) | Vert./Horiz. | No Tab | Clip/Mtg Hole | 44°C @ 2W | 7.9°C/W @ 400 LFM |
| 275-75AB-01 | .750 (19.1) | .835 (21.2) x .400 (12.7) | Vertical | 01 | Clip/Mtg Hole | 44°C @ 2W | 7.9°C/W @ 400 LFM |
| 275-75AB-10 | .875 (12.7) | .835 (21.2) x .400 (14.5) | Vertical | 10 | Clip/Mtg Hole | 44°C @ 2W | 7.9°C/W @ 400 LFM |
| 231-69PAB | .690 (18.4) | .835 (21.2) x .400 (12.7) | Vert./Horiz. | No Tab | Clip/Mtg Hole | 45°C @ 2W | 8°C/W @ 400 LFM |
| 231-69PAB-13H | .400 (38.1) | .690 (17.5) x .835 (12.7) | Horizontal | 13H | Clip/Mtg Hole | 45°C @ 2W | 8°C/W @ 400 LFM |
| 231-69PAB-XXX | .690 (38.1) | .835 (21.2) x .400 (12.7) | Vertical | 13V, 14V, 15V | Clip/Mtg Hole | 45°C @ 2W | 8°C/W @ 400 LFM |
| 231-75PAB | .750 (12.7) | .835 (21.2) x .400 (14.5) | Vert./Horiz. | No Tab | Clip/Mtg Hole | 43°C @ 2W | 7.9°C/W @ 400 LFM |
| 231-75PAB-13H | .400 (41.3) | .750 (19.1) x .835 (12.7) | Horizontal | 13H | Clip/Mtg Hole | 43°C @ 2W | 7.9°C/W @ 400 LFM |
| (14V ▲) 231-75PAB-XXX | .750 (34.9) | .835 (21.2) x .400 (12.7) | Vertical | 13V, 14V, 15V | Clip/Mtg Hole | 43°C @ 2W | 7.9°C/W @ 400 LFM |
| 231-137PAB | 1.375 (10.2) | .835 (21.2) x .400 (12.7) | Vert./Horiz. | No Tab | Clip/Mtg Hole | 32°C @ 2W | 5.9°C/W @ 400 LFM |
| 231-137PAB-13H | .400 (10.2) | 1.375 (34.9) x .835 (12.7) | Horizontal | 13H | Clip/Mtg Hole | 32°C @ 2W | 5.9°C/W @ 400 LFM |
| (15V ▲) 231-137PAB-XXX | 1.375 (10.2) | .835 (21.2) x .400 (12.7) | Vertical | 13V, 14V, 15V | Clip/Mtg Hole | 32°C @ 2W | 5.9°C/W @ 400 LFM |

Material: Aluminum, Pre-anodized Black (PAB), Anodized Black (AB)

MECHANICAL DIMENSIONS

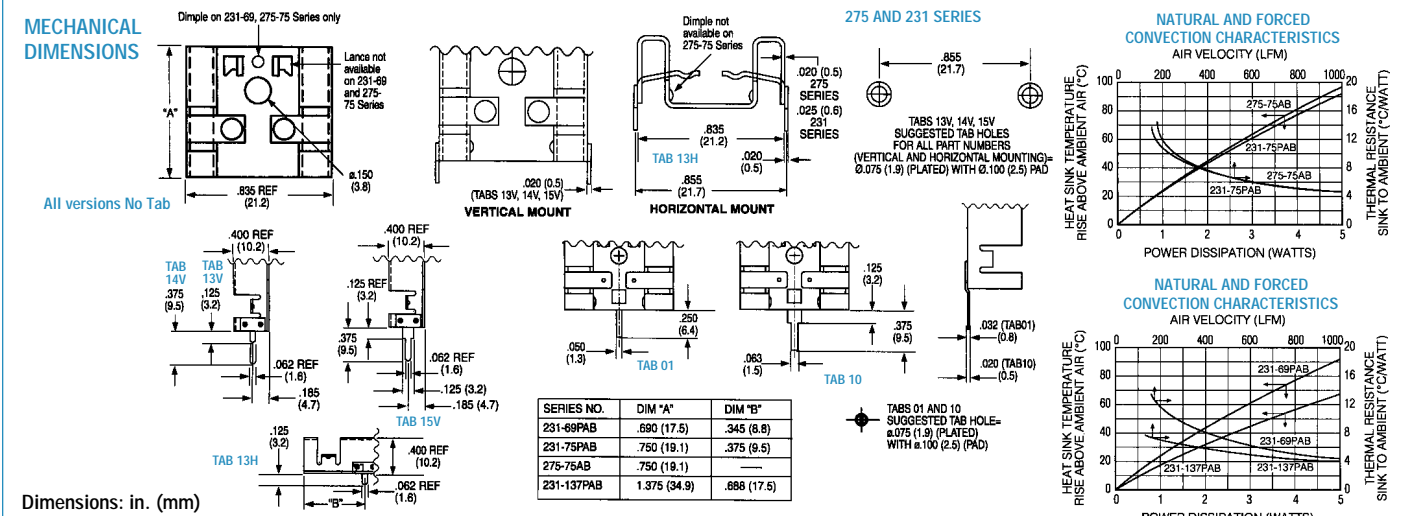

BOARD LEVEL POWER SEMICONDUCTOR HEAT SINKS



PATENT 5381041

235 SERIES Compact, Stress-Free Labor-Saving Locking-Tab Heat Sinks

TO-220

| Standard P/N | Height Above PC Board in. (mm) | Footprint Dimensions in. (mm) | Mounting Configuration | Solderable Tab Options | Mounting Style | Thermal Performance at Typical Load | |
|--------------|--------------------------------|-------------------------------|------------------------|------------------------|----------------|-------------------------------------|-------------------|
| | | | | | | Natural Convection | Forced Convection |
| 235-85AB ▲ | .850 (21.6) | 1.000 (25.4) x .500 (12.7) | Vert./Horiz. | No Tab | Clip/Mtg Hole | 40°C @ 2W | 6.8°C/W @ 400 LFM |
| 235-85AB-01 | .850 (21.6) | 1.000 (25.4) x .500 (12.7) | Vertical | 01 | Clip/Mtg Hole | 40°C @ 2W | 6.8°C/W @ 400 LFM |
| 235-85AB-05 | .500 (12.7) | .850 (21.6) x 1.000 (25.4) | Horizontal | 05 | Clip/Mtg Hole | 40°C @ 2W | 6.8°C/W @ 400 LFM |
| 235-85AB-10 | .975 (24.8) | 1.000 (25.4) x .500 (12.7) | Vertical | 10 | Clip/Mtg Hole | 40°C @ 2W | 6.8°C/W @ 400 LFM |

Material: Aluminum, Black Anodized

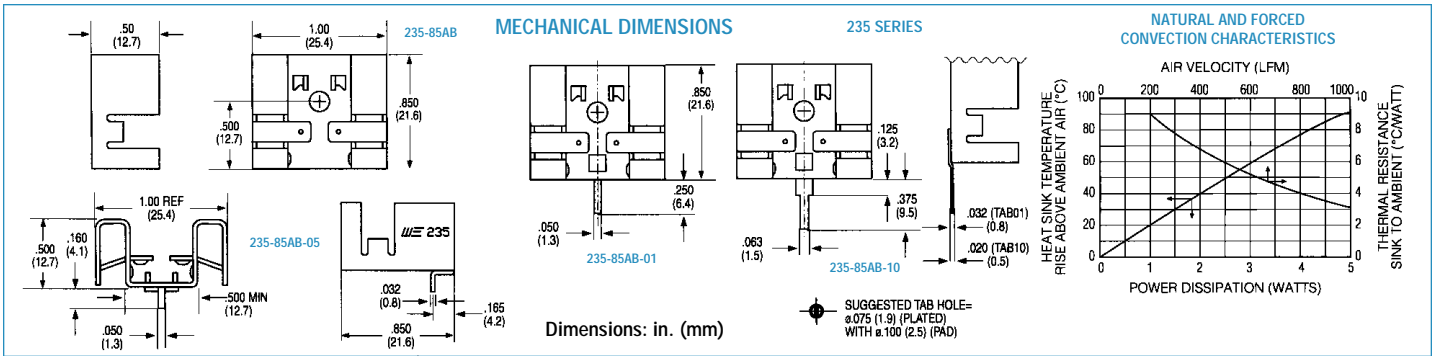

243 SERIES Labor-Saving Clip-On Heat Sinks

TO-220

| Standard P/N | Height Above PC Board in. (mm) | Footprint Dimensions in. (mm) | Mounting Configuration | Solderable Tab Options | Mounting Style | Thermal Performance at Typical Load | |
|--------------|--------------------------------|-------------------------------|------------------------|------------------------|----------------|-------------------------------------|-------------------|
| | | | | | | Natural Convection | Forced Convection |
| 243-1PAB | 1.000 (25.4) | .800 (20.3) x .270 (6.9) | Vert./Horiz. | No Tab | Clip | 50°C @ 2W | 4.5°C/W @ 400 LFM |
| 243-3PAB ▲ | .800 (20.3) | .800 (20.3) x .270 (6.9) | Vert./Horiz. | No Tab | Clip | 78°C @ 2W | 8.2°C/W @ 400 LFM |

Material: Aluminum, Pre-anodized Black

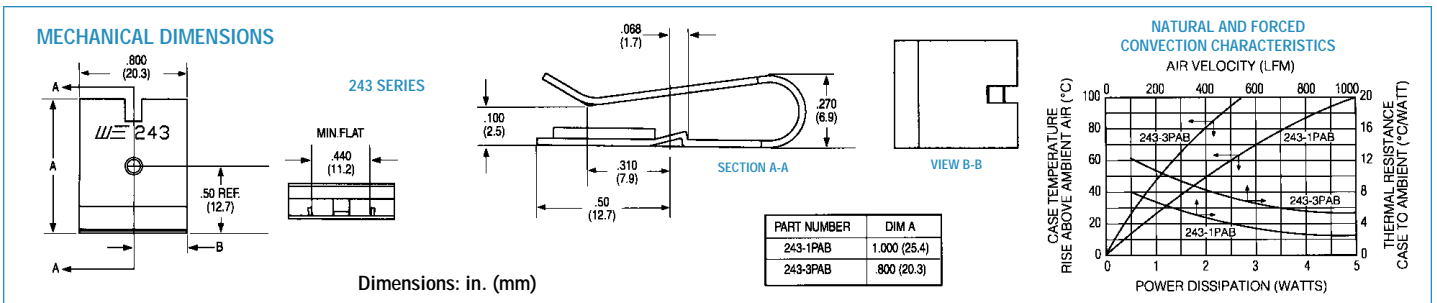

PATENT PENDING

239 SERIES Snap-Down Self-Locking Heat Sinks

TO-220

| Standard P/N | Height Above PC Board in. (mm) | Footprint Dimensions in. (mm) | Mounting Configuration | Solderable Tab Options | Mounting Style | Thermal Performance at Typical Load | |
|--------------|--------------------------------|-------------------------------|------------------------|------------------------|----------------|-------------------------------------|-------------------|
| | | | | | | Natural Convection | Forced Convection |
| 239-75AB | .750 (19.1) | 1.120 (28.4) x .435 (11.0) | Vert./Horiz. | No Tab | Clip/Mtg Hole | 38°C @ 2W | 6°C/W @ 400 LFM |
| 239-75AB-03 | .750 (19.1) | 1.120 (28.4) x .435 (11.0) | Vertical | 03 | Clip/Mtg Hole | 38°C @ 2W | 6°C/W @ 400 LFM |
| 239-75AB-04 | .750 (19.1) | 1.120 (28.4) x .435 (11.0) | Vertical | 04 | Clip/Mtg Hole | 38°C @ 2W | 6°C/W @ 400 LFM |

Material: Aluminum, Black Anodized

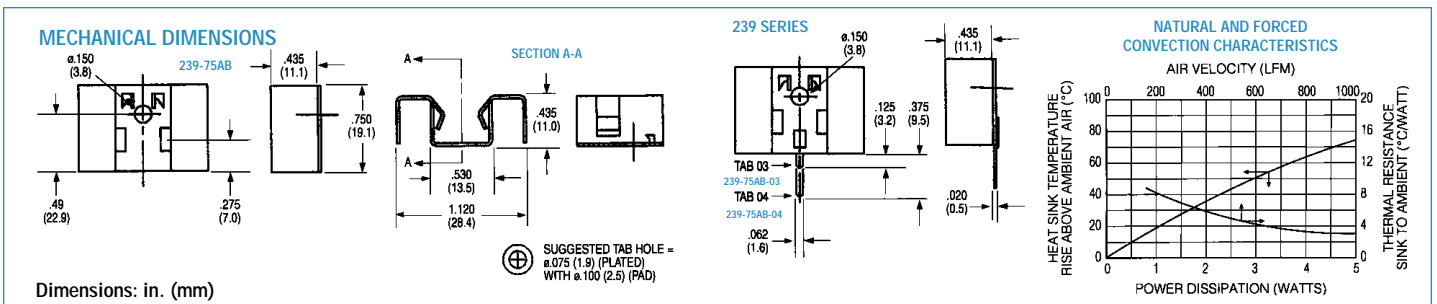

BOARD LEVEL POWER SEMICONDUCTOR HEAT SINKS



273 SERIES Low-Cost, Low-Height Wavesolderable Heat Sinks

TO-218, TO-220

| Standard P/N | Height Above PC Board in. (mm) | Footprint Dimensions in. (mm) | Mounting Configuration | Solderable Tab Options | Mounting Style | Thermal Performance at Typical Load | |
|--------------|--------------------------------|-------------------------------|------------------------|------------------------|----------------|-------------------------------------|-------------------|
| | | | | | | Natural Convection | Forced Convection |
| 273-AB ▲ | .375 (9.5) | .750 (19.1) x .750 (19.1) | Vert./Horiz. | No Tab | Mtg Hole | 49°C @ 2W | 7.2°C/W @ 400 LFM |
| 273-AB-01 | .375 (9.5) | .750 (19.1) x .750 (19.1) | Vertical | 01 | Mtg Hole | 49°C @ 2W | 7.2°C/W @ 400 LFM |
| 273-AB-02 | .375 (9.5) | .750 (19.1) x .750 (19.1) | Vertical | 02 | Mtg Hole | 49°C @ 2W | 7.2°C/W @ 400 LFM |

Material: Aluminum, Black Anodized

MECHANICAL DIMENSIONS

273 SERIES

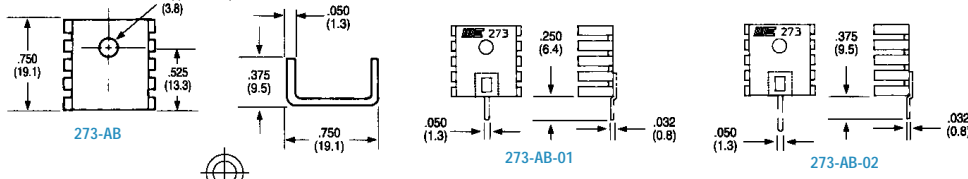

Note: 1. Suggested Tab Hole = ϕ .075 (1.9) (Plated) with ϕ .100 (2.5) pad

Dimensions: in. (mm)

NATURAL AND FORCED CONVECTION CHARACTERISTICS

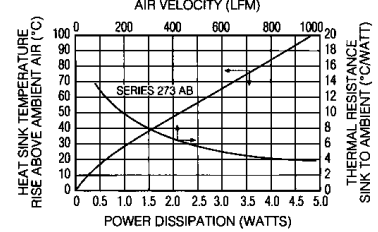

274 SERIES Low-Cost, Low-Height Wavesolderable Heat Sinks

TO-220

| Standard P/N | Height Above PC Board in. (mm) | Footprint Dimensions in. (mm) | Mounting Configuration | Solderable Tab Options | Mounting Style | Thermal Performance at Typical Load | |
|--------------|--------------------------------|-------------------------------|------------------------|------------------------|----------------|-------------------------------------|-------------------|
| | | | | | | Natural Convection | Forced Convection |
| 274-1AB ▲ | .375 (9.5) | .520 (13.2) x .750 (19.1) | Vert./Horiz. | No Tab | Mtg Hole | 56°C @ 2W | 8.0°C/W @ 400 LFM |
| 274-1AB-01 ▲ | .375 (9.5) | .520 (13.2) x .750 (19.1) | Vertical | 01 | Mtg Hole | 56°C @ 2W | 8.0°C/W @ 400 LFM |
| 274-1AB-02 ▲ | .375 (9.5) | .520 (13.2) x .750 (19.1) | Vertical | 02 | Mtg Hole | 56°C @ 2W | 8.0°C/W @ 400 LFM |
| 274-2AB ▲ | .500 (12.7) | .520 (13.2) x .750 (19.1) | Vert./Horiz. | No Tab | Mtg Hole | 50°C @ 2W | 7.0°C/W @ 400 LFM |
| 274-2AB-01 | .500 (12.7) | .520 (13.2) x .750 (19.1) | Vertical | 01 | Mtg Hole | 50°C @ 2W | 7.0°C/W @ 400 LFM |
| 274-2AB-02 | .500 (12.7) | .520 (13.2) x .750 (19.1) | Vertical | 02 | Mtg Hole | 50°C @ 2W | 7.0°C/W @ 400 LFM |
| 274-3AB ▲ | .250 (6.4) | .520 (13.2) x .750 (19.1) | Vert./Horiz. | No Tab | Mtg Hole | 62°C @ 2W | 9.0°C/W @ 400 LFM |
| 274-3AB-01 | .250 (6.4) | .520 (13.2) x .750 (19.1) | Vertical | 01 | Mtg Hole | 62°C @ 2W | 9.0°C/W @ 400 LFM |
| 274-3AB-02 | .250 (6.4) | .520 (13.2) x .750 (19.1) | Vertical | 02 | Mtg Hole | 62°C @ 2W | 9.0°C/W @ 400 LFM |
| 281-1AB | .375 (9.5) | .520 (13.2) x .750 (19.1) | Vertical | No Tab | Mtg Hole | 56°C @ 2W | 8.0°C/W @ 400 LFM |
| 281-2AB | .500 (12.7) | .520 (13.2) x .750 (19.1) | Vertical | No Tab | Mtg Hole | 50°C @ 2W | 7.0°C/W @ 400 LFM |

Material: Aluminum, Black Anodized

MECHANICAL DIMENSIONS

274 SERIES

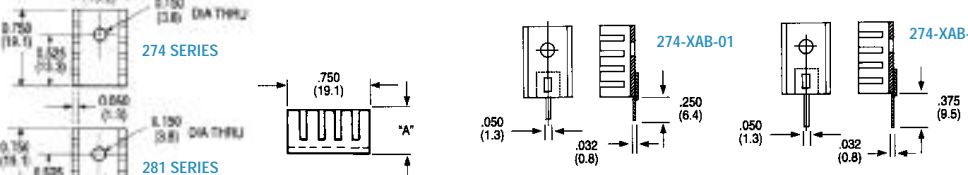

Dimensions: in. (mm)

0.075 (1.9) (plated) 0.100 (2.5) pad
PCB recommended hole/pad size

NATURAL AND FORCED CONVECTION CHARACTERISTICS

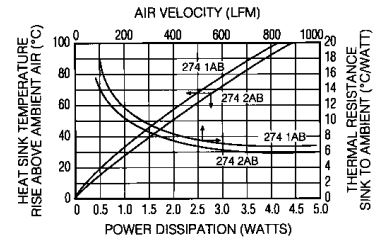

240 SERIES Labor-Saving Twisted Fin Heat Sinks

TO-220

| Standard P/N | Height Above PC Board in. (mm) | Footprint Dimensions in. (mm) | Mounting Configuration | Solderable Tab Options | Mounting Style | Thermal Performance at Typical Load | |
|-----------------|--------------------------------|-------------------------------|------------------------|------------------------|----------------|-------------------------------------|-------------------|
| | | | | | | Natural Convection | Forced Convection |
| 240-118ABH-22 ▲ | 1.180 (30.0) | 1.000 (25.4) x .500 (12.7) | Vertical | 22 | Clip/Mtg Hole | 55°C @ 4W | 5.3°C/W @ 400 LFM |
| 240-118ABS-22 | 1.180 (30.0) | 1.000 (25.4) x .500 (12.7) | Vertical | 22 | Clip/Mtg Slot | 55°C @ 4W | 5.3°C/W @ 400 LFM |

Material: Aluminum, Black Anodized

MECHANICAL DIMENSIONS

240 SERIES

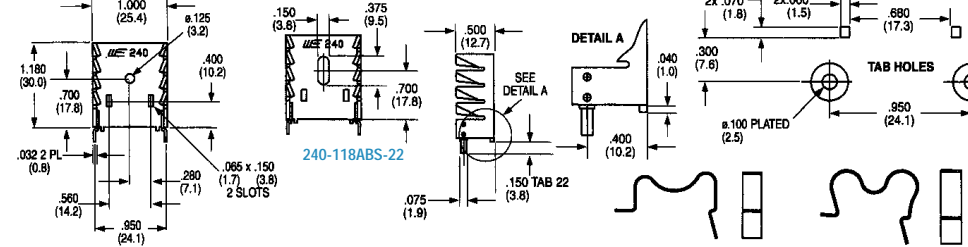

Dimensions: in. (mm)

STAINLESS STEEL 330SC 4# SPRING STEEL 285SC 10#
Order SpeedClips™ Separately

NATURAL AND FORCED CONVECTION CHARACTERISTICS

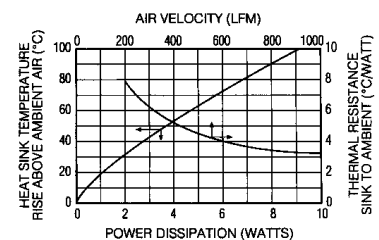

BOARD LEVEL POWER SEMICONDUCTOR HEAT SINKS

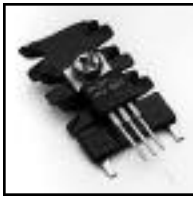

242 SERIES Low-Height, Low-Profile Twisted Fin Heat Sinks

TO-220

| Standard P/N | Height Above PC Board in. (mm) | Footprint Dimensions in. (mm) | Mounting Configuration | Solderable Tab Options | Mounting Style | Thermal Performance at Typical Load | |
|--------------|--------------------------------|-------------------------------|------------------------|------------------------|----------------|-------------------------------------|-------------------|
| | | | | | | Natural Convection | Forced Convection |
| 242-125AB-22 | 1.285 (32.6) | .875 (22.2) x .250 (6.4) | Vertical | 22 | Mtg Hole | 48°C @ 2W | 6.2°C/W @ 400 LFM |

Material: Aluminum, Black Anodized

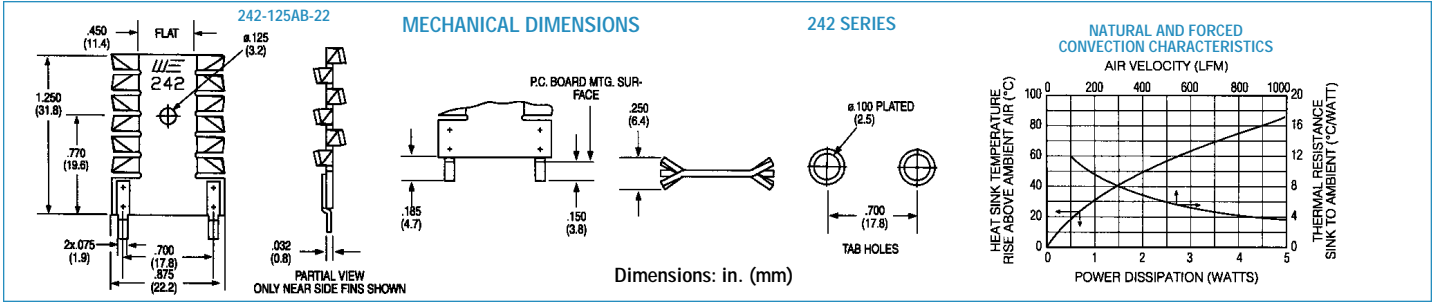

232 AND 238 SERIES Staggered Fin Heat Sinks for Vertical Mounting

TO-202, TO-220

| Standard P/N | Height Above PC Board in. (mm) | Footprint Dimensions in. (mm) | Mounting Configuration | Solderable Tab Options | Mounting Style | Thermal Performance at Typical Load | |
|--------------|--------------------------------|-------------------------------|------------------------|------------------------|----------------|-------------------------------------|-------------------|
| | | | | | | Natural Convection | Forced Convection |
| 232-200AB | 2.000 (50.8) | 1.380 (35.1) x .500 (12.7) | Vertical | 2, Twisted | Clip/Mtg Hole | 48°C @ 4W | 3.3°C/W @ 400 LFM |
| 232-200AB-23 | 2.000 (50.8) | 1.380 (35.1) x .500 (12.7) | Vertical | 2, Solderable | Clip/Mtg Hole | 48°C @ 4W | 3.3°C/W @ 400 LFM |
| 238-200AB | 2.000 (50.8) | 1.380 (35.1) x .500 (12.7) | Vertical | 2, Twisted | Mtg Slot | 48°C @ 4W | 3.3°C/W @ 400 LFM |
| 238-200AB-23 | 2.000 (50.8) | 1.380 (35.1) x .500 (12.7) | Vertical | 2, Solderable | Mtg Slot | 48°C @ 4W | 3.3°C/W @ 400 LFM |

Material: Aluminum, Black Anodized

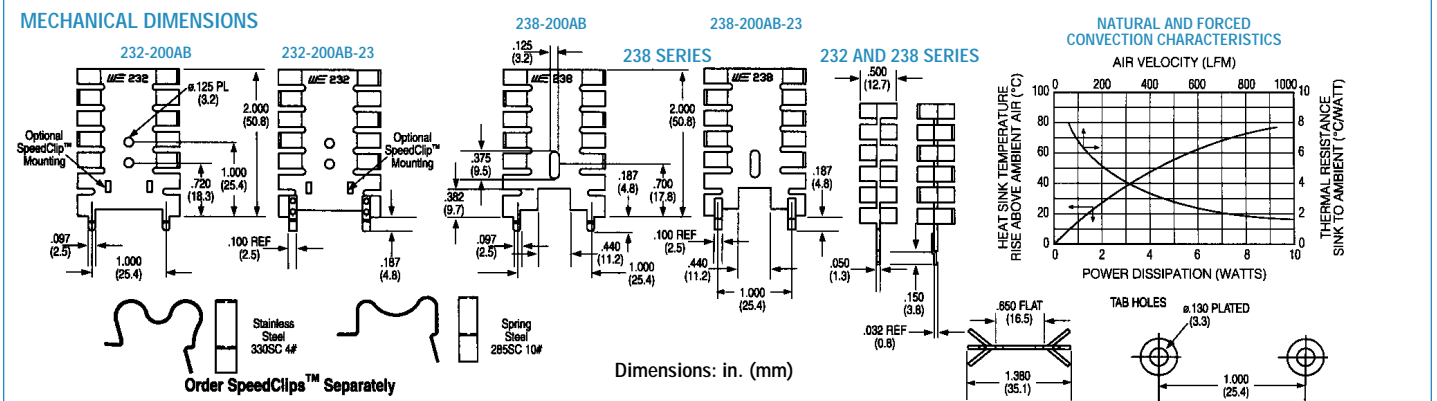

251 SERIES Slim-Profile Heat Sinks With Integral Clips

15 Lead Multiwatt

| Standard P/N | Height Above PC Board in. (mm) | Footprint Dimensions in. (mm) | Mounting Configuration | Solderable Tab Options | Mounting Style | Thermal Performance at Typical Load | |
|--------------|--------------------------------|-------------------------------|------------------------|------------------------|----------------|-------------------------------------|-------------------|
| | | | | | | Natural Convection | Forced Convection |
| 251-62AB | .620 (15.7) | .910 (23.1) x .380 (9.7) | Vert./Horiz. | No Tab | Clip | 66°C @ 3W | 66°C/W @ 400 LFM |
| 251-80AB | .845 (21.5) | .910 (23.1) x .380 (9.7) | Vert./Horiz. | No Tab | Clip | 64°C @ 3W | 66°C/W @ 400 LFM |
| 251-80AB-19 | .875 (22.2) | .910 (23.1) x .380 (9.7) | Vertical | 19 | Clip | 64°C @ 3W | 66°C/W @ 400 LFM |

Material: Aluminum, Black Anodized

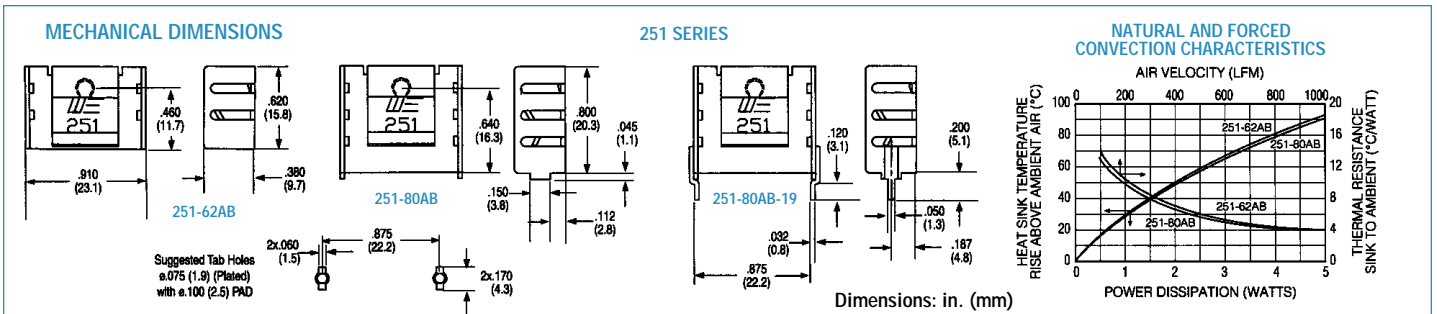

BOARD LEVEL HEAT SINKS FOR TO-220, TO-218 AND MULTIWATT™ COMPONENTS



244 SERIES

Low Height, Slim Profile Wavesolderable Folded Fin Heat Sinks

MULTIWATT

| Standard P/N | Height Above PC Board in. (mm) | Footprint Dimensions in. (mm) | Mounting Configuration | Solderable Tab Options | Thermal Performance at Typical Load | | Weight lbs. (grams) |
|--------------|--------------------------------|-------------------------------|------------------------|------------------------|-------------------------------------|-------------------|---------------------|
| | | | | | Natural Convection | Forced Convection | |
| 244-145AB | 1.450 (36.8) | 1.300 (33.0) x 480 (12.1) | Vert./Horiz. | No Tab | 44°C @ 4W | 4.4°C/W @ 400 LFM | .0160 (7.25) |
| 244-145AB-50 | 1.650 (41.9) | 1.300 (33.0) x 480 (12.1) | Vertical | 50 | 44°C @ 4W | 4.4°C/W @ 400 LFM | .0170 (7.20) |

Material: Aluminum, Black Anodized

MECHANICAL DIMENSIONS

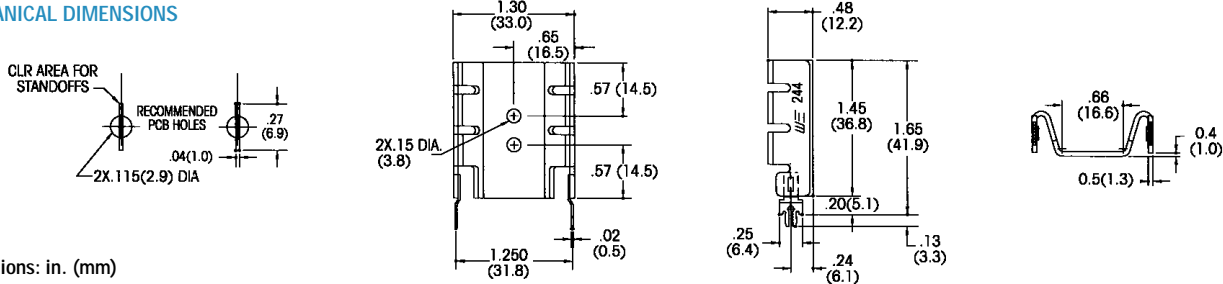

245 SERIES

Low Height, Slim Profile Wavesolderable Folded Fin Heat Sinks

MULTIWATT

| Standard P/N | Height Above PC Board in. (mm) | Footprint Dimensions in. (mm) | Mounting Configuration | Solderable Tab Options | Thermal Performance at Typical Load | | Weight lbs. (grams) |
|--------------|--------------------------------|-------------------------------|------------------------|------------------------|-------------------------------------|-------------------|---------------------|
| | | | | | Natural Convection | Forced Convection | |
| 245-145AB | 1.450 (36.8) | 1.750 (44.5) x .380 (9.7) | Vert./Horiz. | No Tab | 38°C @ 4W | 3.2°C/W @ 400 LFM | .0160 (7.25) |
| 245-145AB-50 | 1.650 (41.9) | 1.750 (44.5) x .380 (9.7) | Vertical | 50 | 38°C @ 4W | 3.2°C/W @ 400 LFM | .0170 (7.20) |

Material: Aluminum, Black Anodized

MECHANICAL DIMENSIONS

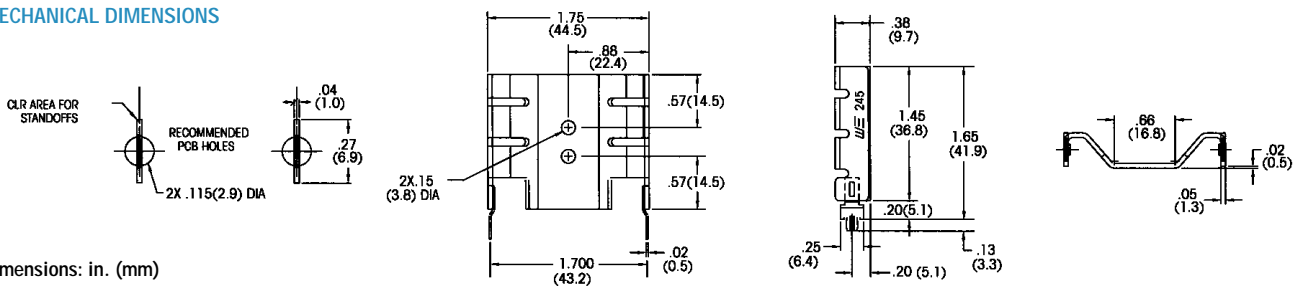

246 SERIES

Medium Height, Slim Profile Wavesolderable Folded Fin Heat Sinks

MULTIWATT

| Standard P/N | Height Above PC Board in. (mm) | Footprint Dimensions in. (mm) | Mounting Configuration | Solderable Tab Options | Thermal Performance at Typical Load | | Weight lbs. (grams) |
|--------------|--------------------------------|-------------------------------|------------------------|------------------------|-------------------------------------|-------------------|---------------------|
| | | | | | Natural Convection | Forced Convection | |
| 246-197AB | 1.968 (50.0) | 1.986 (50.4) x 3.75 (9.5) | Vert./Horiz. | No Tab | 35°C @ 4W | 2.8°C/W @ 400 LFM | .0240 (10.90) |
| 246-197AB-50 | 2.168 (55.1) | 1.986 (50.4) x 3.75 (9.5) | Vertical | 50 | 35°C @ 4W | 2.8°C/W @ 400 LFM | .0250 (11.40) |

Order SpeedClip™ 285SC or 330SC separately. (See 248 Series section).
Material: Aluminum, Black Anodized

MECHANICAL DIMENSIONS

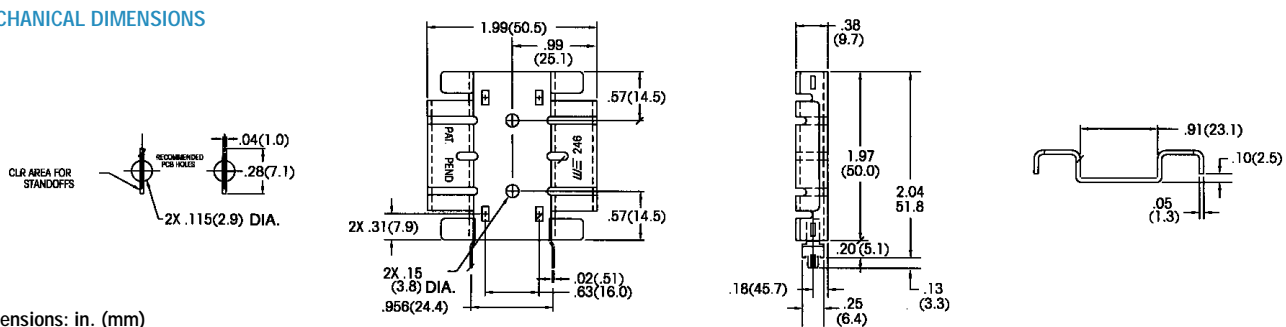

BOARD LEVEL HEAT SINKS FOR TO-220, TO-218 AND MULTIWATT™ COMPONENTS



247 SERIES Medium Height, Deep Profile Wavesolderable Folded Fin Heat Sinks

MULTIWATT

| Standard P/N | Height Above PC Board in. (mm) | Footprint Dimensions in. (mm) | Mounting Configuration | Solderable Tab Options | Thermal Performance at Typical Load | | Weight lbs. (grams) |
|--------------|--------------------------------|-------------------------------|------------------------|------------------------|-------------------------------------|-------------------|---------------------|
| | | | | | Natural Convection | Forced Convection | |
| 247-195AB | 1.950 (49.5) | 1.900 (48.3) x .950 (24.1) | Vert./Horiz. | No Tab | 25°C @ 4W | 2.4°C/W @ 400 LFM | .0330 (15.10) |
| 247-195AB-50 | 1.950 (49.5) | 1.900 (48.3) x .950 (24.1) | Vertical | 50 | 25°C @ 4W | 2.4°C/W @ 400 LFM | .0340 (15.60) |

Order SpeedClip™ 285SC or 330SC separately. (See 248 Series section).
Material: Aluminum, Black Anodized

MECHANICAL DIMENSIONS

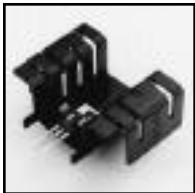
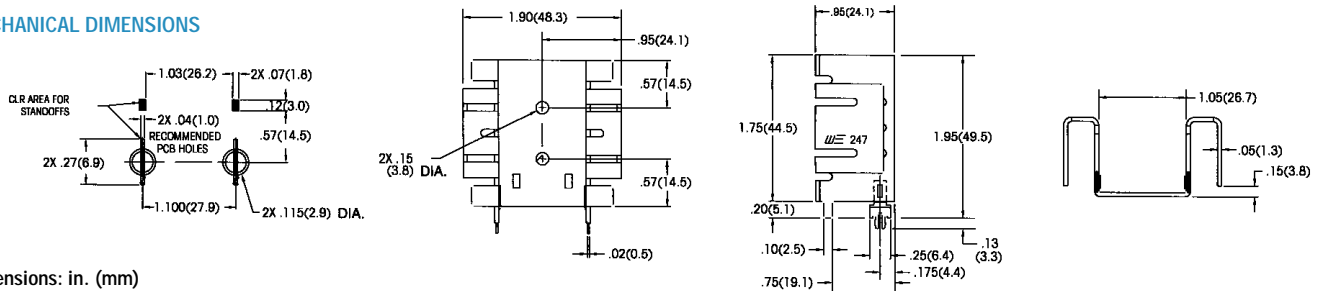

248 SERIES Low Height, Medium Profile Wavesolderable Folded Fin Heat Sinks

MULTIWATT

| Standard P/N | Height Above PC Board in. (mm) | Footprint Dimensions in. (mm) | Mounting Configuration | Solderable Tab Options | Thermal Performance at Typical Load | | Weight lbs. (grams) |
|--------------|--------------------------------|-------------------------------|------------------------|------------------------|-------------------------------------|-------------------|---------------------|
| | | | | | Natural Convection | Forced Convection | |
| 248-162AB | 1.620 (41.1) | 2.000 (50.8) x .750 (19.1) | Vert./Horiz. | No Tab | 35°C @ 4w | 2.5°C/W @ 400 LFM | .026 (11.60) |
| 248-162AB-50 | 1.620 (41.1) | 2.000 (50.8) x .750 (19.1) | Vertical | 50 | 35°C @ 4w | 2.5°C/W @ 400 LFM | .027 (12.20) |

Order SpeedClip™ 285SC or 330SC separately.
Material: Aluminum, Black Anodized

MECHANICAL DIMENSIONS

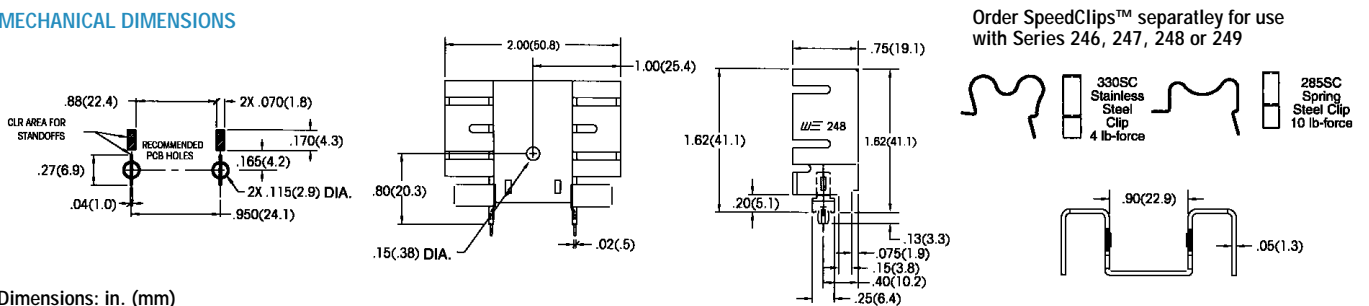

249 SERIES Medium Height, Deep Profile Wavesolderable Folded Fin Heat Sinks

MULTIWATT

| Standard P/N | Height Above PC Board in. (mm) | Footprint Dimensions in. (mm) | Mounting Configuration | Solderable Tab Options | Thermal Performance at Typical Load | | Weight lbs. (grams) |
|--------------|--------------------------------|-------------------------------|------------------------|------------------------|-------------------------------------|--------------------|---------------------|
| | | | | | Natural Convection | Forced Convection | |
| 249-113AB | 1.130 (28.7) | 1.900 (48.3) x .950 (24.1) | Vert./Horiz. | No Tab | 35°C @ 4W | 3.29°C/W @ 400 LFM | .020 (8.90) |
| 249-113AB-50 | 1.130 (28.7) | 1.900 (48.3) x .950 (24.1) | Vertical | 50 | 35°C @ 4W | 3.29°C/W @ 400 LFM | .021 (9.40) |

Order SpeedClip™ 285SC or 330SC separately. (See 248 Series section).
Material: Aluminum, Black Anodized

MECHANICAL DIMENSIONS

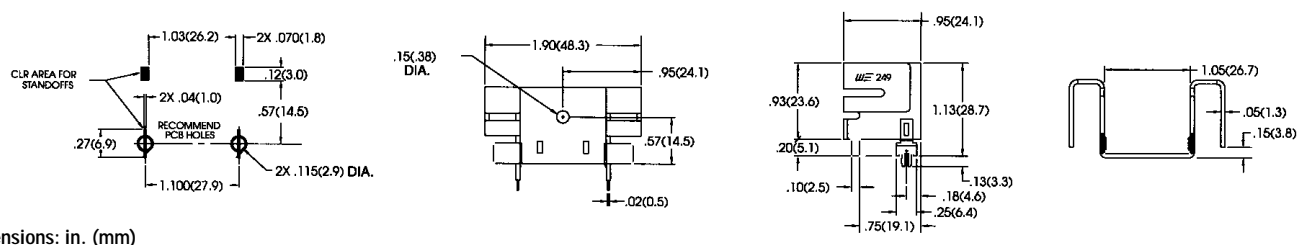

BOARD LEVEL POWER SEMICONDUCTOR HEAT SINKS



288 SERIES Compact Wave-Solderable Low-Cost Heat Sinks

TO-220, TO-202

| Standard P/N | Height Above PC Board in. (mm) | Maximum Footprint in. (mm) | Thermal Performance at Typical Load | | Weight lbs. (grams) |
|--------------|--------------------------------|----------------------------|-------------------------------------|-------------------|---------------------|
| | | | Natural Convection | Forced Convection | |
| 288-1AB ▲ | 1.250 (31.8) | 0.875 (22.2) x 0.215 (5.5) | 85°C @ 4W | 12°C/W @ 200 LFM | 0.0057 (2.59) |

Mounting tabs are pre-tinned to ensure excellent wave-solder bond and good electrical connections for vertical mounting of TO-220 and TO-202 semiconductor packages. These heat sinks are designed for use where minimum PC

board space is available. The 288-1AB is a stamped aluminum heat sink, black anodized, designed for applications requiring good heat dissipation from a heat sink occupying minimum space, available at minimum cost.

MECHANICAL DIMENSIONS

288 SERIES

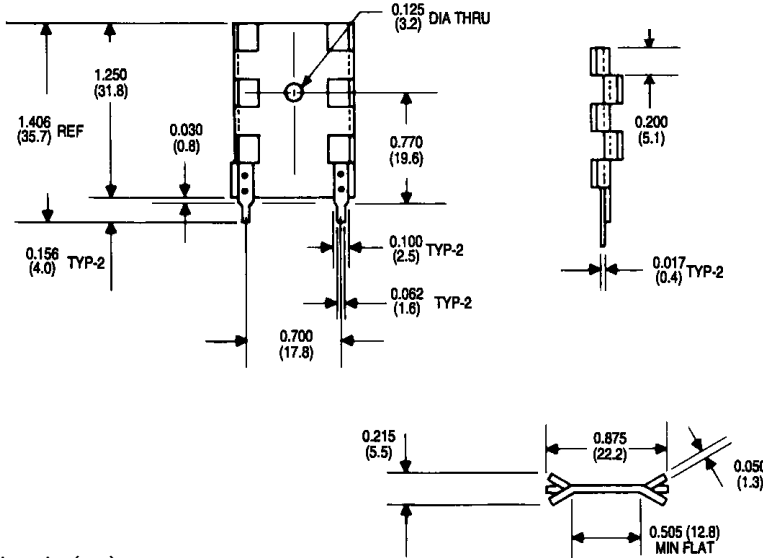

NATURAL AND FORCED CONVECTION CHARACTERISTICS

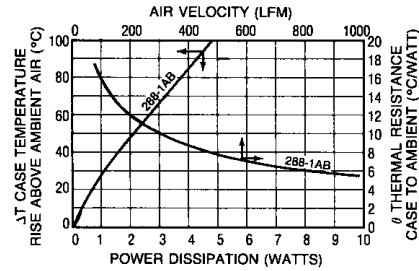

271 SERIES Top-Mount Booster Heat Sinks for Use with 270/272/280 Series

TO-220

| Standard P/N | Height Above Semiconductor Case in. (mm) | Horizontal Mounting Footprint Dimensions in. (mm) | Thermal Performance at Typical Load | | Weight lbs. (grams) |
|--------------|--|---|--|---|---------------------|
| | | | Natural Convection | Forced Convection | |
| 271-AB ▲ | 0.500 (12.7) | 1.750 (44.5) x 0.700 (17.8) | 62°C @ 4W (NOTE A) 31°C @ 4W (NOTE B) | 5.1°C/W @ 400 LFM 1.8°C/W 400 LFM (NOTE B) | 0.0052 (2.36) |

Material: Aluminum, Black Anodized

This top-hat style booster heat sink can be added to any of the 270, 272, or 280 Series for improved performance.

NOTE A: Thermal resistance with one 271-AB. NOTE B: Thermal resistance (total) as shown with (2) 271-AB types added to (1) 272-AB type.

MECHANICAL DIMENSIONS

271 SERIES

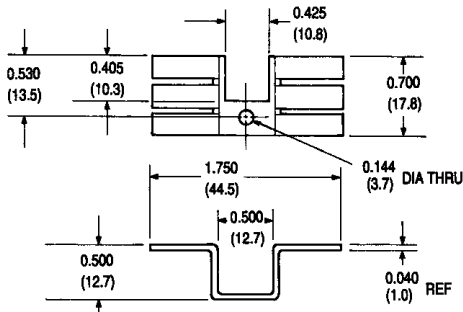

NATURAL AND FORCED CONVECTION CHARACTERISTICS

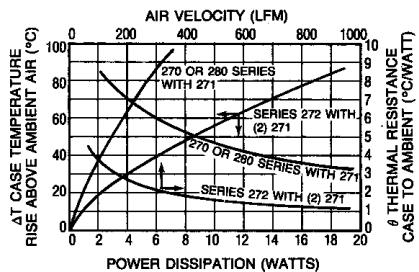

BOARD LEVEL POWER SEMICONDUCTOR HEAT SINKS



270/272/280 SERIES Small Footprint Low-Cost Heat Sinks

TO-220, TO-202

| Standard P/N | Height Above PC Board in. (mm) | Horizontal Mounting Maximum Footing in. (mm) | Solderable Tab Options | Thermal Performance at Typical Load | | Weight lbs. (grams) |
|--------------|--------------------------------|--|------------------------|-------------------------------------|-------------------|---------------------|
| | | | | Natural Convection | Forced Convection | |
| 270-AB ▲ | 0.375 (9.4) | 1.750 (44.5) x 0.700 (17.8) | — | 70°C @ 4W | 6.0°C/W @ 400 LFM | 0.0052 (2.36) |
| 272-AB ▲ | 0.375 (9.4) | 1.750 (44.5) x 1.450 (36.8) | 01,02 | 42°C @ 4W | 3.6°C/W @ 400 LFM | 0.0105 (5.72) |
| 280-AB | 0.375 (9.4) | 1.750 (44.5) x 0.700 (17.8) | — | 70°C @ 4W | 6.0°C/W @ 400 LFM | 0.0048 (2.18) |

Material: Aluminum, Black Anodized

These exceptionally low-cost heat sinks can be mounted horizontally under a TO-220 or TO-202 case style with a maximum height of only 0.375 in. (9.4). For added performance, a 271 Series heat sink can also be used for double-sided heat dissi-

ipation. The 270-AB and 280-AB accept one power semiconductor; the 272-AB is designed for two power semiconductors. Specify solderable tab options for the 272 Series by the addition of suffix "01" or "02" to the standard part number (i.e. 272-AB01 or 272-AB02).

MECHANICAL DIMENSIONS

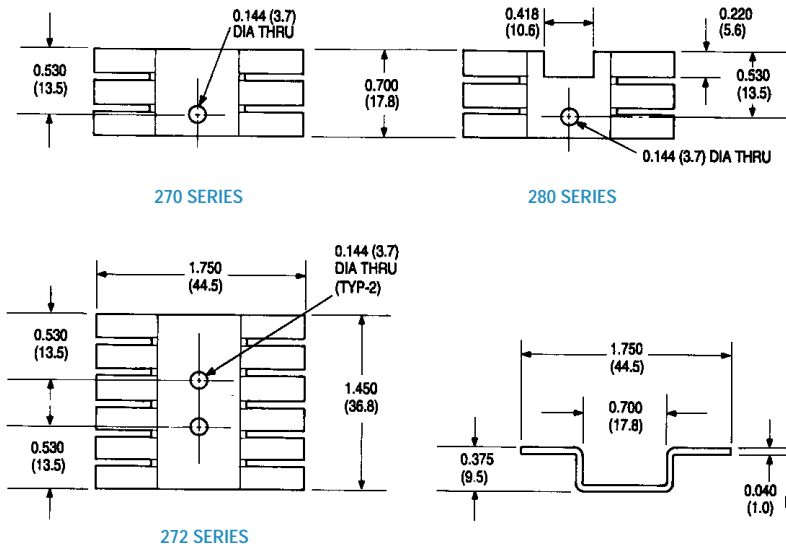

Dimensions: in. (mm)

NATURAL AND FORCED CONVECTION CHARACTERISTICS

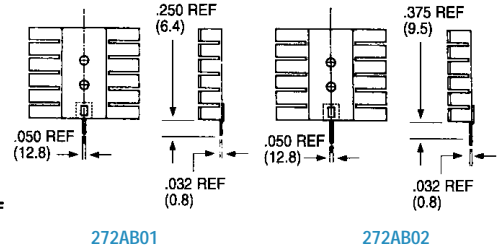
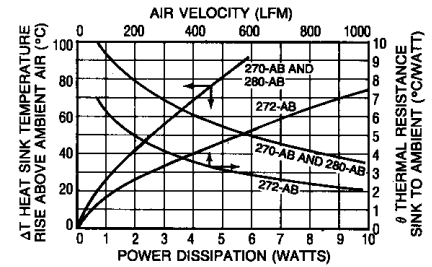

Note:
1. Suggested Tab Hole = 0.075 ±0.003 plated with 0.100 pad



289 AND 290 SERIES Low-Cost Single or Dual Package Heat Sinks

TO-218, TO-202, TO-220

| Standard P/N | Height Above PC Board in. (mm) | Horizontal Mounting Maximum Footing in. (mm) | Thermal Performance at Typical Load | | Weight lbs. (grams) |
|--------------|--------------------------------|--|-------------------------------------|-------------------|---------------------|
| | | | Natural Convection | Forced Convection | |
| 289-AB ▲ | 0.500 (12.7) | 1.000 (25.4) x 0.710 (18.1) | 50°C @ 2W | 44°C/W @ 400 LFM | 0.0055 (2.49) |
| 289-AP | 0.500 (12.7) | 1.000 (25.4) x 0.710 (18.1) | 50°C @ 2W | 44°C/W @ 400 LFM | 0.0055 (2.49) |
| 290-1AB ▲ | 0.500 (12.7) | 1.000 (25.4) x 1.180 (30.0) | 44°C @ 2W | 35°C/W @ 400 LFM | 0.0082 (3.72) |
| 290-2AB ▲ | 0.500 (12.7) | 1.000 (25.4) x 1.180 (30.0) | 44°C @ 2W | 35°C/W @ 400 LFM | 0.0081 (3.67) |

Material: Aluminum, Black Anodized

Low in cost and compact in overall dimensions, one 289 Series heat sink can accommodate one semiconductor; the 289 Series is available with a black anodized finish (289-AB) or with

no finish (289-AP). Two semiconductors can be mounted to the 290-2AB style.

289 SERIES

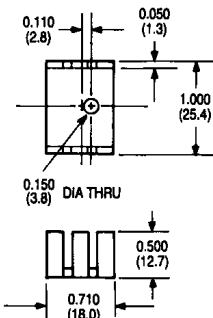

MECHANICAL DIMENSIONS

290 SERIES

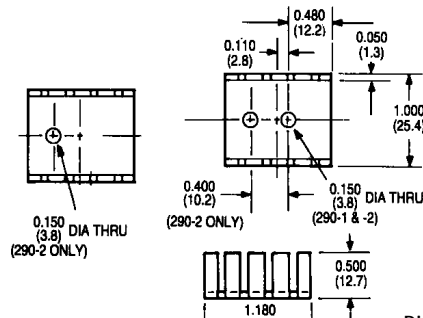

Dimensions: in. (mm)

NATURAL AND FORCED CONVECTION CHARACTERISTICS

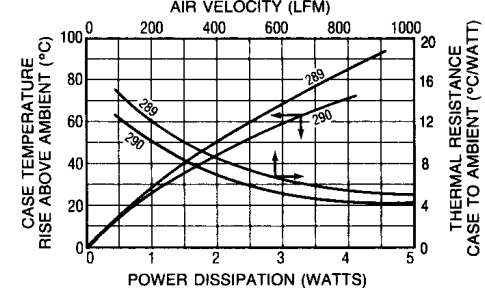

BOARD LEVEL POWER SEMICONDUCTOR HEAT SINKS



250 SERIES High-Performance Slim Profile Heat Sinks With Integral Clips

Multiwatt

| Standard P/N | Height Above PC Board in. (mm) | Footprint Dimensions in. (mm) | Mounting Configuration | Solderable Tab Options | Mounting Style | Thermal Performance at Typical Load | |
|----------------|--------------------------------|-------------------------------|------------------------|------------------------|----------------|-------------------------------------|-------------------|
| | | | | | | Natural Convection | Forced Convection |
| 250-122AB | 1.220 (31.0) | 1.000 (25.4) x .500 (12.7) | Vert./Horiz. | No Tab | Clip | 50°C @ 4W | 3.7°C/W @ 400 LFM |
| 250-122AB-09 ▲ | 1.220 (31.0) | 1.000 (25.4) x .500 (12.7) | Vertical | 09 | Clip | 50°C @ 4W | 3.7°C/W @ 400 LFM |
| 250-122AB-25 | 1.380 (35.1) | 1.000 (25.4) x .500 (12.7) | Vertical | 25 | Clip | 50°C @ 4W | 3.7°C/W @ 400 LFM |

Material: Aluminum, Black Anodized

MECHANICAL DIMENSIONS

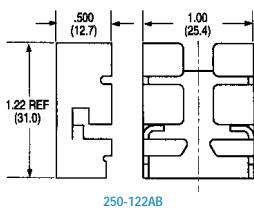

Dimensions: in. (mm)

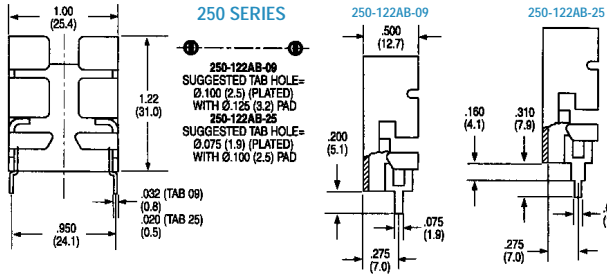

NATURAL AND FORCED CONVECTION CHARACTERISTICS

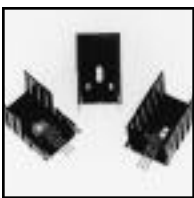
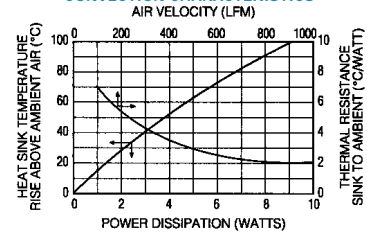

237 AND 252 SERIES High-Performance, High-Power Vertical Mount Heat Sinks

TO-220

| Standard P/N | Height Above PC Board in. (mm) | Footprint Dimensions in. (mm) | Mounting Configuration | Solderable Tab Options | Mounting Style | Thermal Performance at Typical Load | |
|---------------|--------------------------------|-------------------------------|------------------------|------------------------|----------------|-------------------------------------|-------------------|
| | | | | | | Natural Convection | Forced Convection |
| 237-167AB2 | 1.675 (42.5) | 1.000 (25.4) x 1.000 (25.4) | Vertical | 2, Twisted | Clip/Mtg Slot | 46°C @ 4W | 4.5°C/W @ 200 LFM |
| 237-167AB3 | 1.675 (42.5) | 1.000 (25.4) x 1.000 (25.4) | Vertical | 3, Twisted | Clip/Mtg Slot | 46°C @ 4W | 4.5°C/W @ 200 LFM |
| 237-167AB2-24 | 1.675 (42.5) | 1.000 (25.4) x 1.000 (25.4) | Vertical | 2, Solderable | Clip/Mtg Slot | 46°C @ 4W | 4.5°C/W @ 200 LFM |
| 252-167AB2 | 1.675 (42.5) | 1.000 (25.4) x 1.000 (25.4) | Vertical | 2, Twisted | Clip/Mtg Slot | 40°C @ 4W | 4.5°C/W @ 200 LFM |
| 252-167AB3 | 1.675 (42.5) | 1.000 (25.4) x 1.000 (25.4) | Vertical | 3, Twisted | Clip/Mtg Slot | 40°C @ 4W | 4.5°C/W @ 200 LFM |
| 252-167AB2-24 | 1.675 (42.5) | 1.000 (25.4) x 1.000 (25.4) | Vertical | 2, Solderable | Clip/Mtg Slot | 40°C @ 4W | 4.5°C/W @ 200 LFM |

Order SpeedClips™ 285SC or 330SC separately for rapid component installation, lowering manufacturing costs. Material: Aluminum, Black Anodized

MECHANICAL DIMENSIONS

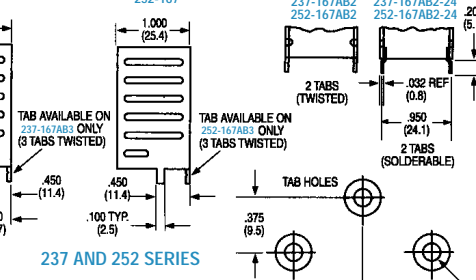
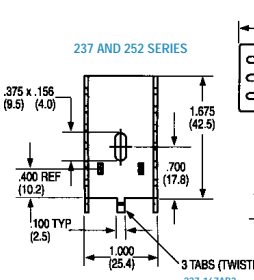

NATURAL AND FORCED CONVECTION CHARACTERISTICS

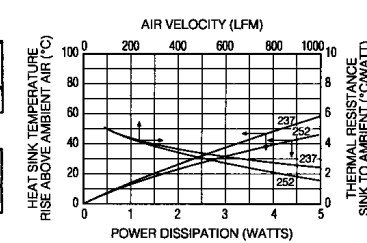

291 SERIES Labor-Saving Clip-on Heat Sinks

TO-220

| Standard P/N | Height Above PC Board in. (mm) | Vertical Mounting Footprint Dimensions in. (mm) | Mounting Style | Thermal Performance at Typical Load | | Weight lbs. (grams) |
|--------------|--------------------------------|---|--------------------|-------------------------------------|-------------------|---------------------|
| | | | | Natural Convection | Forced Convection | |
| 291-C236AB | 0.860 (21.9) | 1.100 (27.0) x 0.360 (9.1) | TO-220 (Clip) | 80°C @ 2W | 24°C/W @ 600 LFM | 0.0026 (1.18) |
| 291-H36AB ▲ | 0.860 (21.9) | 1.100 (27.0) x 0.360 (9.1) | TO-220 (Mtg. Hole) | 68°C @ 2W | 16°C/W @ 600 LFM | 0.0026 (1.18) |

Material: Aluminum, Black Anodized

Designed for mounting horizontally or vertically on a circuit board, 291 Series heat sinks employ a unique clip for attachment of TO-220 case styles.

One type is available with a locking clip and one with a 0.140 in. (3.6) diameter mounting hole only.

MECHANICAL DIMENSIONS

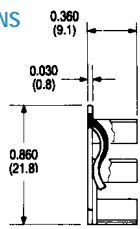

Dimensions: in. (mm)

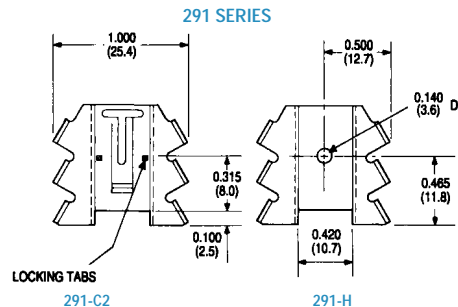

NATURAL AND FORCED CONVECTION CHARACTERISTICS

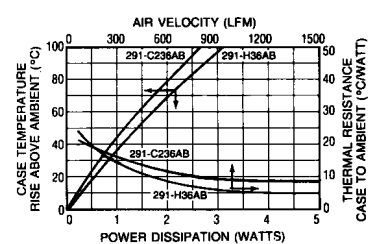

BOARD LEVEL POWER SEMICONDUCTOR HEAT SINKS



286 SERIES Aluminum and Copper Low-Cost Wave-Solderable Heat Sinks

TO-220

| Standard P/N | Height Above PC Board in. (mm) | Maximum Footprint in. (mm) | Material | Thermal Performance at Typical Load | | Weight lbs. (grams) |
|--------------|--------------------------------|-----------------------------|--------------------|-------------------------------------|-------------------|---------------------|
| | | | | Natural Convection | Forced Convection | |
| 286-AB ▲ | 1.190 (30.2) | 1.000 (25.4) x 0.500 (12.7) | Aluminum, Anodized | 58°C @ 4W | 7.4°C/W @ 200 LFM | 0.0085 (3.86) |
| 286-CBT ▲ | 1.190 (30.2) | 1.000 (25.4) x 0.500 (12.7) | Copper, Black | 58°C @ 4W | 7.4°C/W @ 200 LFM | 0.0250 (11.34) |
| 286-CT | 1.190 (30.2) | 1.000 (25.4) x 0.500 (12.7) | Copper, Tinned | 58°C @ 4W | 7.4°C/W @ 200 LFM | 0.0250 (11.34) |

Efficient heat removal at low cost can be achieved by inserting the 286 Series directly into pre-drilled circuit boards; scored mounting tabs may be bent after insertion to provide added stability.

The 286 Series can be wavesoldered directly to the board. Material: 286-AB style (aluminum, black anodized), 286-CBT style (copper, black paint tin tabs), and 286-CT style (copper, tinned).

MECHANICAL DIMENSIONS

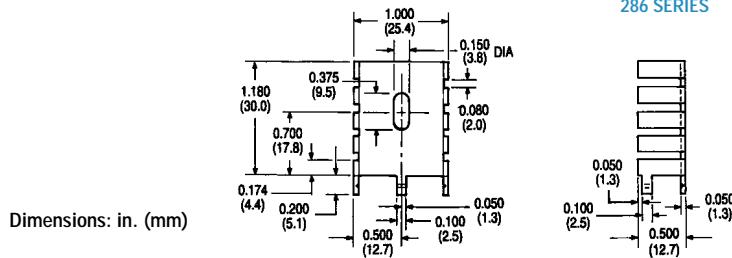

NATURAL AND FORCED CONVECTION CHARACTERISTICS

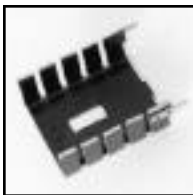
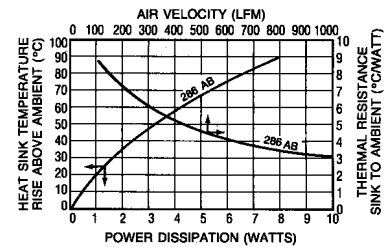

287 SERIES Wave-Solderable Low-Cost Heat Sinks

TO-220

| Standard P/N | Mounting Slot | Mounting Hole | Height Above PC Board in. (mm) | Maximum Footprint "A" in. (mm) | Thermal Performance at Typical Load | | Weight lbs. (grams) |
|--------------|---------------|---------------|--------------------------------|--------------------------------|-------------------------------------|-------------------|---------------------|
| | | | | | Natural Convection | Forced Convection | |
| 287-1AB ▲ | 287-1ABH ▲ | 287-1ABH ▲ | 1.180 (30.0) | 1.000 (25.4) x 0.500 (12.7) | 65°C @ 4W | 7.8°C/W @ 200 LFM | 0.0090 (4.08) |
| 287-2AB ▲ | 287-2ABH | 287-2ABH | 1.180 (30.0) | 1.000 (25.4) x 1.000 (25.4) | 55°10 @ 4W | 6.4°C/W @ 200 LFM | 0.0140 (6.35) |

Material: Aluminum, Black Anodized

Mount these cost-effective TO-220 heat sinks vertically into pre-drilled printed circuit boards. Soldered, pre-tinned tabs can be wavesoldered directly to the board. A 0.375 in. (9.5 mm)

mounting slot allows for correct positioning of TO-220 and similar semiconductor packages.

MECHANICAL DIMENSIONS

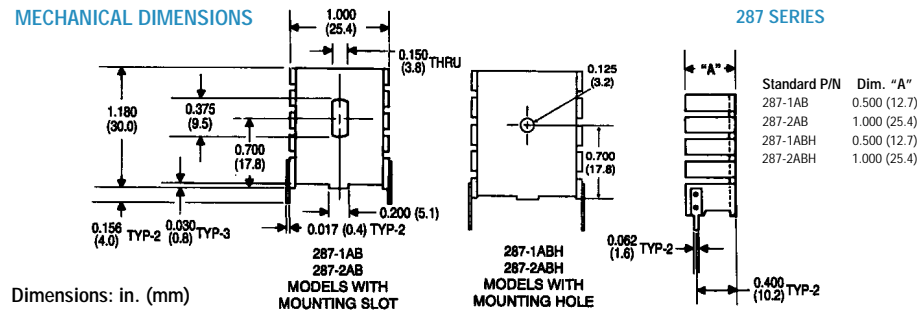

NATURAL AND FORCED CONVECTION CHARACTERISTICS

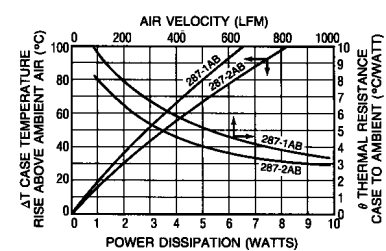

695 SERIES Space-Saving Heat Sinks for Small Stud-Mounted Diodes

STUD-MOUNT

| Standard P/N | Maximum Width in. (mm) | Height in. (mm) | Thermal Performance at Typical Load | Weight lbs. (grams) |
|--------------|------------------------|-----------------|---|---------------------|
| 695-1B ▲ | 1.330 (33.8) | 0.530 (13.7) | 72°C @ 4.0W Natural Convection 5.2°C/W @ 400 LFM Forced Convection | 0.0030 (1.36) |

Mount and effectively heat sink small stud-mounted diodes with the 695 Series space-saving heat sink type. Each unit is black anodized aluminum with an 0.200 in. (5.1) dia. mounting hole centered in the base. The folded fin design

provides good heat dissipation for use where height is limited above the printed circuit board or base plate.

MECHANICAL DIMENSIONS

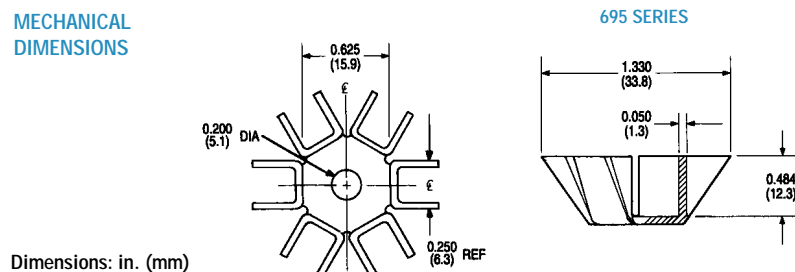

NATURAL AND FORCED CONVECTION CHARACTERISTICS

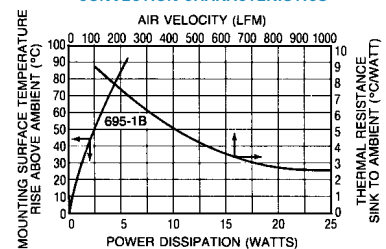

BOARD LEVEL POWER SEMICONDUCTOR HEAT SINKS



256 SERIES Thermal Retainers

| Standard P/N | Height (Less Mounting Tab) in. (mm) | Material | Weight lbs. (grams) |
|--------------|--|------------------|------------------------|
| 256-DM ▲ | 0.190 (4.0) | Beryllium Copper | 0.0005 (0.23) |

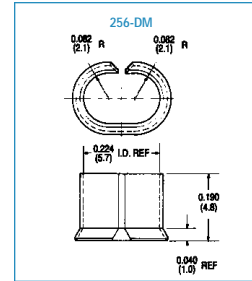

TO-92

260 SERIES Cup Clips for TO-5 Case Style Semiconductors

TO-5

| Characteristics | TO-5 |
|---|----------|
| Thermal Resistance – Epoxy Insulated | 14° C/W |
| Thermal Resistance – Beryllium Oxide Insulated | 16° C/W |
| Breakdown Voltage – Epoxy Type (VAC), 60 Hz | 500 |
| Breakdown Voltage – Beryllium Type (VAC), 60 Hz | 1000 |
| Recommended Operating Voltage, AC or DC | |
| Clean Conditions: % Hipot Rating | 50 |
| Dusty Conditions: % Hipot Rating | 30 |
| Dirty Conditions: % Hipot Rating | 10 to 20 |
| Temperature Range — Continuous (C°) | -73/+149 |

| Model | Depth of Tapped Base |
|-----------|----------------------|
| 260-4T5E | 0.093 (2.36) |
| 260-4TH5E | 0.125 (3.18) |
| 260-4TH5B | 0.125 (3.18) |

Thread Size:
4 = #4-40 UNC
6 = #6-32 UNC
10 = #10-32 UNF

Mounting Style:
T = tapped
S = stud
P = plain

Base Style: H = hex
Semiconductor Case Style: 5 = TO-5
Insulation: E = epoxy
Type: B = beryllium



TO-5 CASE STYLE CUP CLIPS — ORDERING GUIDE

| Standard P/N | Insulation Type | Outline Dimension L x W x I.D. in. (mm) | Weight lbs. (grams) | Case Style |
|--------------|---------------------------|---|------------------------|------------|
| 260-4T5E ▲ | Epoxy Insulated | 0.370 (9.4) x 0.380 (9.7) dia. x 0.290 (7.4) | 0.0024 (1.09) | TO-5 |
| 260-4TH5E ▲ | Epoxy Insulated | 0.400 (10.2) x 0.370 (9.4) hex. x 0.290 (7.4) | 0.0031 (1.41) | TO-5 |
| 260-6SH5E ▲ | Epoxy Insulated | 0.557 (14.1) x 0.370 (9.4) hex. x 0.290 (7.4) | 0.0037 (1.68) | TO-5 |
| 260-10SH5E | Epoxy Insulated | 0.557 (14.1) x 0.370 (9.4) hex. x 0.290 (7.4) | 0.0042 (1.91) | TO-5 |
| 260-4TH5B ▲ | Beryllium Oxide Insulated | 0.445 (11.3) x 0.370 (9.4) hex. x 0.290 (7.4) | 0.0042 (1.91) | TO-5 |
| 260-6SH5B ▲ | Beryllium Oxide Insulated | 0.607 (15.4) x 0.370 (9.4) hex. x 0.290 (7.4) | 0.0039 (1.77) | TO-5 |
| 260-10SH5B | Beryllium Oxide Insulated | 0.607 (15.4) x 0.370 (9.4) hex. x 0.290 (7.4) | 0.0043 (1.95) | TO-5 |

Materials and Finish: Cups – beryllium copper, black ebolon "C"; Bases – brass, black ebolon "C"; Ceramic Spacers – beryllium oxide

Base Mounting Configurations — TO-5

Plain Type — Epoxy bonded, or used with #4 pan head screws.

Tapped Base — #4-40 UNC screw (not supplied) fits tapped hole. Care should be taken not to use too long a screw, which could short against the semiconductor case. For correct screw lengths:

Correct Screw Length (L) = Depth of Base + Panel Thickness + Washer Thickness

Stud Mounting Base. #6-32 UNC or #10-32 UNF studs. Nuts and washers not supplied. Stud hole must be slightly countersunk to ensure flat mounting.

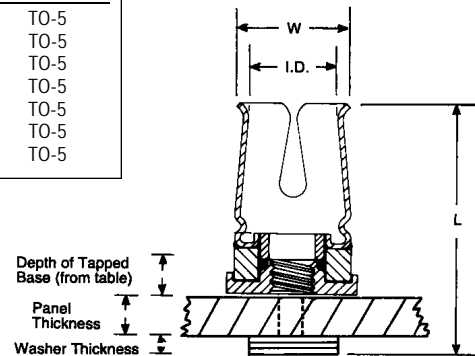
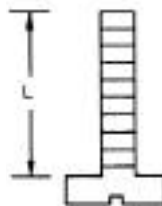

To determine the correct mounting screw lengths, add dimensions as follows:

Correct Screw Length (L) = Depth of Base + Panel Thickness + Washer Thickness

Epoxy Insulated For TO-5

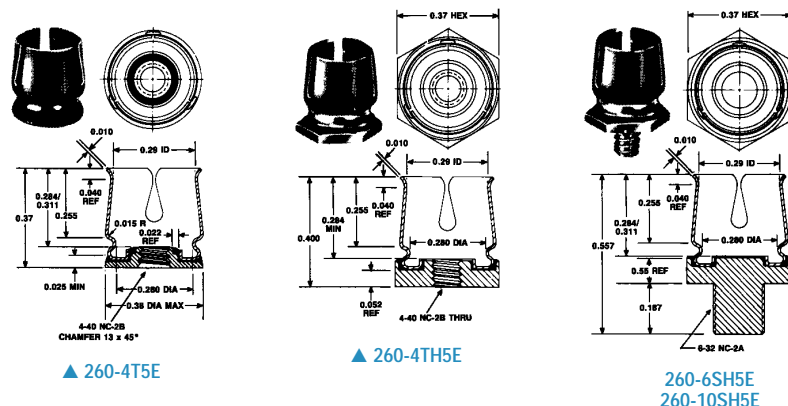

Beryllium Oxide Insulated For TO-5

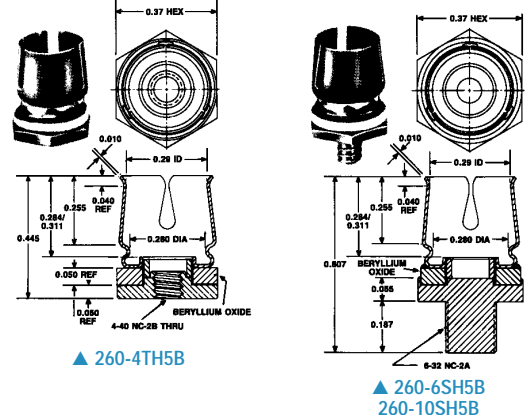

BOARD LEVEL POWER SEMICONDUCTOR HEAT SINKS

200 SERIES High-Efficiency Heat Sinks for Small Metal Can Power Semiconductors

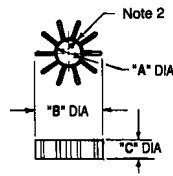

Single-Level Star
201, 202, 204, 205, 211 Series

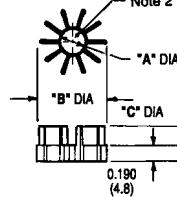

Dual-Level Star
203, 207, 213 Series

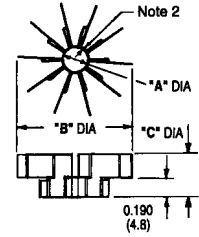
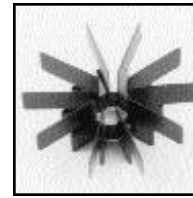

Dual-Level Sunburst
209, 215 Series

| Available Standard P/N & Finish Types | Semiconductor Case Diameter Min/Max in. (mm) | Heat Sink Inside Dia. "A" in. (mm) | Heat Sink Outside Dia. "B" in. (mm) | Heat Sink Height "C" in. (mm) | Natural Convection Case Rise Above Ambient | Forced Convection (CA@200 LFM) | Applicable Power Semiconductor Case Types |
|---------------------------------------|--|------------------------------------|-------------------------------------|-------------------------------|--|--------------------------------|---|
| ▲ 201CB, 201AB | 0.161 (4.1)/0.240 (6.1) | 0.150 (3.8) | 0.640 (16.2) | 0.187 (4.8) | 65°C @ 1W | 31°C/W | TO-18, TO-24, TO-28, TO-40, TO-44 |
| 202CB | 0.161 (4.1)/0.240 (6.1) | 0.150 (3.8) | 0.490 (12.5) | 0.187 (4.8) | 73°C @ 1W | 43°C/W | |
| 203CB | 0.161 (4.1)/0.240 (6.1) | 0.150 (3.8) | 0.640 (16.2) | 0.375 (9.5) | 53°C @ 1W | 23°C/W | |
| 204CB ▲, 204SB | 0.275 (7.0)/0.370 (9.4) | 0.255 (6.5) | 0.550 (4.8) | 0.187 (4.8) | 68°C @ 1W | 35°C/W | TO-5, TO-9, TO-11, TO-12, TO-26, TO-29, TO-33, TO-43, TO-45 |
| 205CB ▲, 205SB | 0.275 (7.0)/0.370 (9.4) | 0.255 (6.5) | 0.720 (18.3) | 0.187 (4.8) | 59°C @ 1W | 28°C/W | |
| 205AB, 205AP | 0.275 (7.0)/0.370 (9.4) | 0.255 (6.5) | 0.720 (18.3) | 0.187 (4.8) | 68°C @ 1W | 28°C/W | |
| 207CB ▲, 207SB ▲ | 0.275 (7.0)/0.370 (9.4) | 0.255 (6.5) | 0.720 (18.3) | 0.375 (9.5) | 46°C @ 1W | 20°C/W | |
| 207AB ▲, 207AP | 0.275 (7.0)/0.370 (9.4) | 0.255 (6.5) | 0.720 (18.3) | 0.375 (9.5) | 53°C @ 1W | 20°C/W | |
| 209CB, 209SB | 0.275 (7.0)/0.370 (9.4) | 0.255 (6.5) | 1.280 (32.5) | 0.437 (11.1) | 30°C @ 1W | 13°C/W | |
| 211CB | 0.440 (11.2)/0.544 (13.8) | 0.420 (10.7) | 0.830 (21.1) | 0.187 (4.8) | 50°C @ 1W | 24°C/W | TO-8, TO-38 |
| 213CB, 213SB | 0.440 (11.2)/0.544 (13.8) | 0.420 (10.7) | 0.830 (21.1) | 0.375 (9.5) | 44°C @ 1W | 19°C/W | |
| 213AB, 213AP | 0.440 (11.2)/0.544 (13.8) | 0.420 (10.7) | 0.830 (21.1) | 0.375 (9.5) | 51°C @ 1W | 19°C/W | |
| 215CB, 215AB | 0.440 (11.2)/0.544 (13.8) | 0.420 (10.7) | 1.400 (35.6) | 0.437 (11.1) | 28°C @ 1W | 15°C/W | |
| 215AP | 0.440 (11.2)/0.544 (13.8) | 0.420 (10.7) | 1.400 (35.6) | 0.437 (11.1) | 32°C @ 1W | 15°C/W | |

Materials and Finishes Available for 200 Series:

- CB Beryllium copper; black ebolon "C" Finish
- SB Silver-bearing copper; black ebolon "C" Finish
- AB Aluminum, black anodized
- AP Aluminum, no finish applied

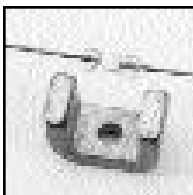
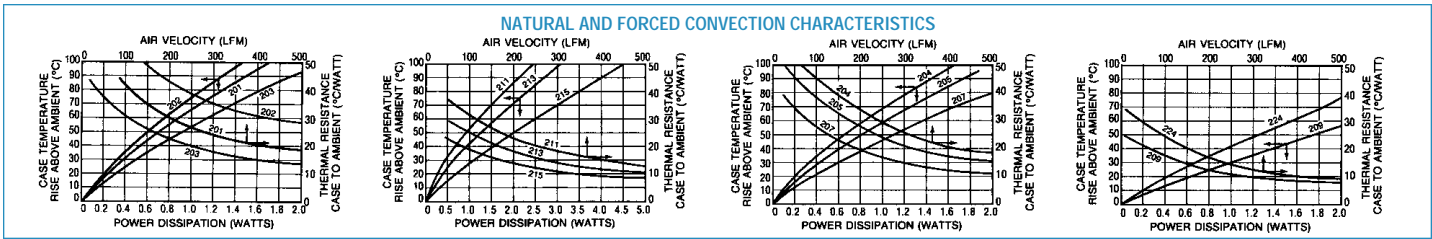

258 SERIES Thermal Links for Fused Glass Diodes

DIODES

| Standard P/N | Dimensions in. (mm) | Material | Finish | Weight lbs. (grams) |
|--------------|--|----------|---|---------------------|
| 258 ▲ | 0.500 (12.7) x 0.250 (6.4) x 0.340 (8.6) | Aluminum | DeltaCoate™ 151 on all surfaces except solder pads and base | 0.0018 (0.82) |

MECHANICAL DIMENSIONS

258 SERIES

Dimensions: in. (mm)

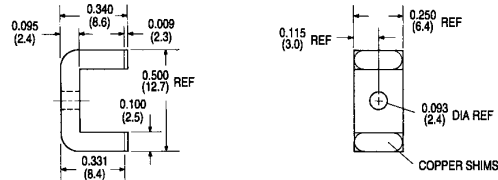

The thermal resistance from diode leads to chassis or heat sink is 12°C/watt, when unit is mounted with TYPE 120 Joint Compound. If a 10°C/watt chassis or sink to ambient impedance is available, the thermal resistance from the diode leads to ambient is reduced from about 150°C/watt to 22°C/watt.

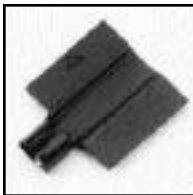

292 SERIES Heat Sink for Single TO-92

TO-92

| Standard P/N | Height Above PC Board in. (mm) | Overall Fin Width in. (mm) | Thermal Performance Natural Convection | Finish | Weight lbs. (grams) |
|--------------|--------------------------------|----------------------------|--|----------------|---------------------|
| 292-AB ▲ | 0.750 (19.1) | 0.600 (15.3) | 0.225°C/W @ 0.250 W | Black Anodized | 0.00049 (0.22) |

MECHANICAL DIMENSIONS

292 SERIES

NATURAL AND FORCED CONVECTION CHARACTERISTICS

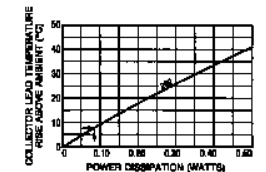
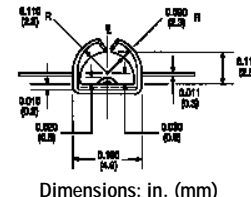
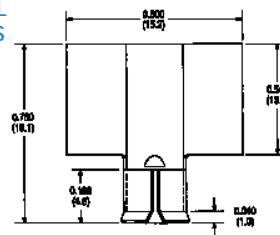

Power semiconductors packaged in a TO-92 style plastic case can be cooled effectively at little additional cost with the addition of the 292-AB heat sink. The 292-AB is effective over the typical power range of such devices. Material: Aluminum, Black Anodized.

BOARD LEVEL POWER SEMICONDUCTOR HEAT SINKS



634 SERIES Slim Profile Unidirectional Fin Vertical Mount Heat Sink

TO-220 and TO-218

| Plain Pin | Standard P/N | | Height Above PC Board in. (mm) | Footprint Dimensions in. (mm) | Weight lbs. (grams) |
|-------------|--------------|-------------|--------------------------------|-------------------------------|---------------------|
| | With Pin | Without Pin | | | |
| 634-10ABP ▲ | 634-10AB | | 1.000 (25.4) | 0.640 (16.26) x 0.640 (16.26) | 0.016 (7.48) |
| 634-15ABP ▲ | 634-15AB | | 1.500 (38.1) | 0.640 (16.26) x 0.640 (16.26) | 0.025 (11.21) |
| 634-20ABP ▲ | 634-20AB | | 2.000 (50.8) | 0.640 (16.26) x 0.640 (16.26) | 0.033 (14.95) |

Material: Aluminum, Black Anodized.

These slim profile unidirectional fin heat sinks offer users two assembly alternatives for vertically mounting TO-220 and TO-218 components. Models are available with or without wave-

solderable pins on 0.40 in. (10.2) centers, making them ideal for a variety of applications where quick assembly is needed and space is at a premium.

MECHANICAL DIMENSIONS

634 SERIES

Notes:

1. Thermal compound is assumed between device and heat sink.
2. Tab temp with longer heat sink (634-20ABP) will typically be about 15% cooler. Tab temp with shorter heat sink (634-10ABP) will typically be about 25% higher.

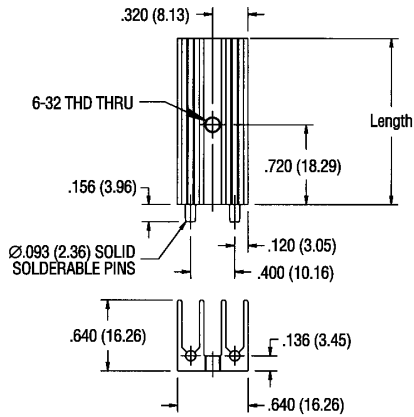

Dimensions: in. (mm)

TYPICAL THERMAL PERFORMANCE FOR 634-15ABP

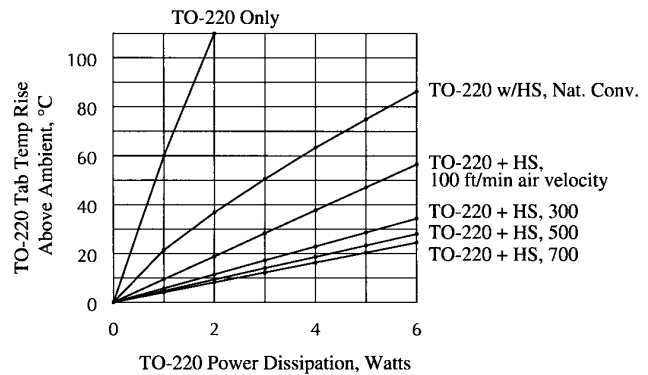

637 SERIES High-Efficiency Heat Sinks For Vertical Board Mounting

TO-220

| Standard P/N | Height Above PC Board "A" in. (mm) | Maximum Footprint in. (mm) | Thermal Performance at Typical Load | | Weight lbs. (grams) |
|--------------|------------------------------------|-----------------------------|-------------------------------------|-------------------|---------------------|
| | | | Natural Convection | Forced Convection | |
| 637-10ABP ▲ | 1.000 (25.4) | 1.375 (34.9) x 0.500 (12.7) | 76°C @ 6W | 5.8°C/W @ 200 LFM | 0.023 (10.43) |
| 637-15ABP ▲ | 1.500 (38.1) | 1.375 (34.9) x 0.500 (12.7) | 65°C @ 6w | 5.5°C/W @ 200 LFM | 0.035 (15.88) |
| 637-20ABP ▲ | 2.000 (50.8) | 1.375 (34.9) x 0.500 (12.7) | 55°C @ 6W | 4.7°C/W @ 200 LFM | 0.050 (22.68) |
| 637-25ABP ▲ | 2.500 (63.5) | 1.375 (34.9) x 0.500 (12.7) | 48°C @ 6W | 4.2°C/W @ 200 LFM | 0.062 (28.12) |

Material: Aluminum, Black Anodized

Wave-solderable pins on 1 in. centers for vertical mounting on printed circuit boards. Maximum semiconductor package width 0.625 in. (15.9). Use this heat sink where weight

and board space occupied must be minimized. Refer to the Accessory products section for thermal interface materials, thermal compounds, and other accessories products.

MECHANICAL DIMENSIONS

637 SERIES (EXTRUSION PROFILE 5183)

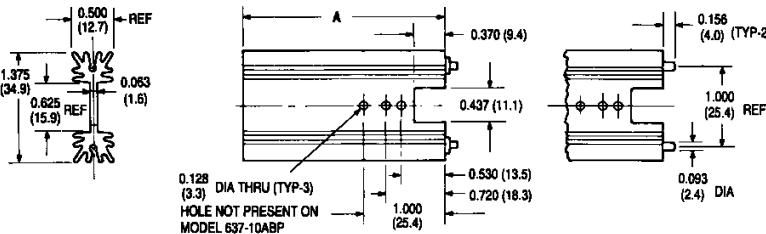

Dimensions: in. (mm)

NATURAL AND FORCED CONVECTION CHARACTERISTICS

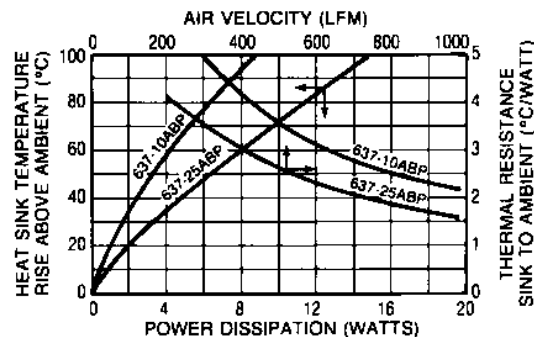

BOARD LEVEL POWER SEMICONDUCTOR HEAT SINKS



667 SERIES Labor-Saving SpeedClip™ Heat Sinks for Vertical Board Mounting

TO-220

| Standoff Pin | Standard P/N Plain Pin | Height Above PC Board "A" in. (mm) | Maximum Footprint in. (mm) | Thermal Performance at Typical Load | | Weight lbs (grams) |
|--------------|------------------------|------------------------------------|-----------------------------|-------------------------------------|-------------------|--------------------|
| | | | | Natural Convection | Forced Convection | |
| 667-10ABSP ▲ | 667-10ABPP ▲ | 1.000 (25.4) | 1.375 (34.9) x 0.500 (12.7) | 76°C @ 6W | 5.8°C/W @ 200 LFM | 0.0240 (11.0) |
| 667-15ABSP | 667-15ABPP ▲ | 1.500 (38.1) | 1.375 (34.9) x 0.500 (12.7) | 66°C @ 6W | 5.5°C/W @ 200 LFM | 0.0340 (15.6) |
| 667-20ABSP | 667-20ABPP | 2.000 (50.8) | 1.375 (34.9) x 0.500 (12.7) | 58°C @ 6W | 4.7°C/W @ 200 LFM | 0.0460 (21.0) |
| 667-25ABSP | 667-25ABPP | 2.500 (63.5) | 1.375 (34.9) x 0.500 (12.7) | 48°C @ 6W | 4.2°C/W @ 200 LFM | 0.0580 (26.2) |

Wave-solderable pins. Material: Aluminum, Black Anodized

Excellent performance, choice of wave-solderable plain pins (PP-Type) or wave-solderable hex-shaped standoff pins (SP-Type), and reduced assembly cost.

Note: Order 330 SC or 285 SC SpeedClip™ separately.

MECHANICAL DIMENSIONS

667 SERIES (EXTRUSION PROFILE 8073)

NATURAL AND FORCED CONVECTION CHARACTERISTICS

Dimensions: in. (mm)



285 AND 330 SERIES 285 SC and 330 SC SpeedClips™ for 667 Series Heat Sinks

| Standard P/N | Nominal Installed Loading Force | For Use With Series | Material | Weight lbs. (grams) |
|--------------|---------------------------------|-------------------------|-----------------|---------------------|
| 285 SC | 10 lbs | 232, 237, 240, 252, 667 | Carbon Steel | 0.00053 (0.24) |
| 330 SC | 4 lbs | 232, 237, 240, 252, 667 | Stainless Steel | 0.00074 (0.34) |

SpeedClips™ employ a locking safety tab for mounting. Must be ordered separately for these heat sink series. Use these SpeedClips™ with our 237, 240, 252, and 667 Series heat sinks

for the lowest production assembly time and cost. Order one SpeedClip™ for each 667 Series heat sink purchased.

MECHANICAL DIMENSIONS

Speed Clip 330 SC 4 lb Nominal Force Installed

Speed Clip 285 SC 10 lb Nominal Force Installed

Dimensions: in. (mm)



647 SERIES High-Performance Heat Sinks for Vertical Board Mounting

TO-220

| Standard P/N | Height Above PC Board "A" in. (mm) | Maximum Footprint in. (mm) | Thermal Performance at Typical Load | | Weight lbs. (grams) |
|--------------|------------------------------------|-----------------------------|-------------------------------------|-------------------|---------------------|
| | | | Natural Convection | Forced Convection | |
| 647-10ABP ▲ | 1.000 (25.4) | 1.650 (41.9) x 1.000 (25.4) | 42°C @ 6W | 3.8°C/W @ 200 LFM | 0.055 (24.95) |
| 647-15ABP ▲ | 1.500 (38.1) | 1.650 (41.9) x 1.000 (25.4) | 37°C @ 6W | 3.5°C/W @ 200 LFM | 0.075 (34.02) |
| 647-175ABP | 1.750 (44.5) | 1.650 (41.9) x 1.000 (25.4) | 34°C @ 6W | 3.3°C/W @ 200 LFM | 0.090 (40.82) |
| 647-20ABP ▲ | 2.000 (50.8) | 1.650 (41.9) x 1.000 (25.4) | 31°C @ 6W | 3.1°C/W @ 200 LFM | 0.104 (47.17) |
| 647-25ABP | 2.500 (63.5) | 1.650 (41.9) x 1.000 (25.4) | 25°C @ 6W | 2.8°C/W @ 200 LFM | 0.125 (56.70) |

Material: Aluminum, Black Anodized

Wave-solderable pins on 1 in. centers for vertical mounting of larger devices on printed circuit boards. Maximum semiconductor package width: 0.625 (15.9). Refer to the Accessory

Products section for thermal interface materials, 126 Series silicone-free thermal compounds, and other accessories products.

MECHANICAL DIMENSIONS

647 SERIES (EXTRUSION PROFILE 5195)

NATURAL AND FORCED CONVECTION CHARACTERISTICS

Dimensions: in. (mm)

BOARD LEVEL POWER SEMICONDUCTOR HEAT SINKS



626 AND 627 SERIES High-Efficiency Heat Sinks for Vertical Board Mounting

TO-218, TO-220

| Standard P/N | Standard P/N | Height Above PC Board "A" in. (mm) | Maximum Footprint in. (mm) | Thermal Performance at Typical Load | |
|--------------|--------------|------------------------------------|----------------------------|-------------------------------------|-------------------|
| | | | | Natural Convection | Forced Convection |
| 626-10ABP | 627-10ABP | 1.000 (25.4) | 1.375 (34.9) x .500 (12.7) | 76°C @ 6W | 5.8°C/W @ 200 LFM |
| 626-15ABP | 627-15ABP | 1.500 (38.1) | 1.375 (34.9) x .500 (12.7) | 65°C @ 6W | 5.5°C/W @ 200 LFM |
| 626-20ABP | 627-20ABP | 2.000 (50.8) | 1.375 (34.9) x .500 (12.7) | 55°C @ 6W | 4.7°C/W @ 200 LFM |
| 626-25ABP | 627-25ABP | 2.500 (63.5) | 1.375 (34.9) x .500 (12.7) | 48°C @ 6W | 4.2°C/W @ 200 LFM |

Wave-solderable pins. Material: Aluminum, Black Anodized

MECHANICAL DIMENSIONS

626 AND 627 SERIES

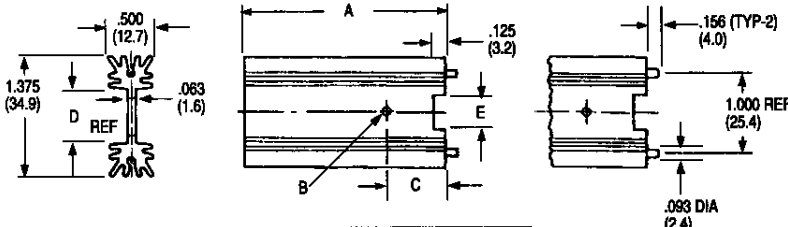

NATURAL AND FORCED CONVECTION CHARACTERISTICS

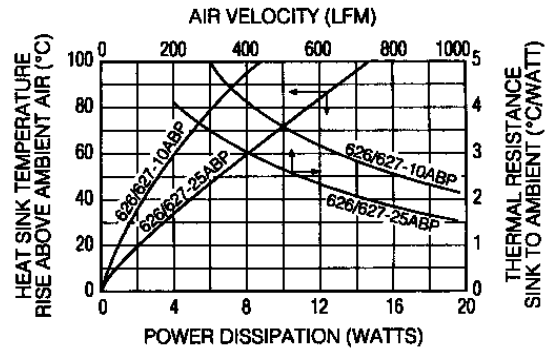

| Series | Type Device | Hole Diameter "B" | Hole Height "C" | Webb Width "D" | Notch Width "E" | Extrusion Profile |
|--------|-------------|-------------------|-----------------|----------------|-----------------|-------------------|
| 626 | TO-218 | .144 (3.7) | .850 (21.6) | .660 (16.8) | .540 (13.7) | 8420 |
| 627 | TO-220 | .128 (3.3) | .720 (18.3) | .625 (15.9) | .437 (11.1) | 5183 |

Dimensions: in. (mm)

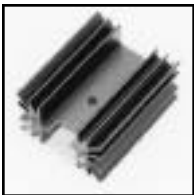

657 SERIES High-Performance Heat Sinks for Vertical Board Mounting

TO-220, TO-247, TO-218

| Standard P/N | Height Above PC Board "A" in. (mm) | Maximum Footprint in. (mm) | Thermal Performance at Typical Load | | Weight lbs (grams) |
|--------------|------------------------------------|-----------------------------|-------------------------------------|-------------------|--------------------|
| | | | Natural Convection | Forced Convection | |
| 657-10ABP ▲ | 1.000 (25.4) | 1.650 (41.9) x 1.000 (25.4) | 41°C @ 6W | 3.7°C/W @ 200 LFM | 0.0515 (23.36) |
| 657-15ABP ▲ | 1.500 (38.1) | 1.650 (41.9) x 1.000 (25.4) | 38°C @ 6W | 3.3°C/W @ 200 LFM | 0.0760 (34.60) |
| 657-20ABP ▲ | 2.000 (50.8) | 1.650 (41.9) x 1.000 (25.4) | 32°C @ 6W | 2.9°C/W @ 200 LFM | 0.1030 (47.00) |
| 657-25ABP ▲ | 2.500 (63.5) | 1.650 (41.9) x 1.000 (25.4) | 25°C @ 6W | 2.7°C/W @ 200 LFM | 0.1250 (57.00) |

Wave-solderable pins. Material: Aluminum, Black Anodized

MECHANICAL DIMENSIONS

657 SERIES

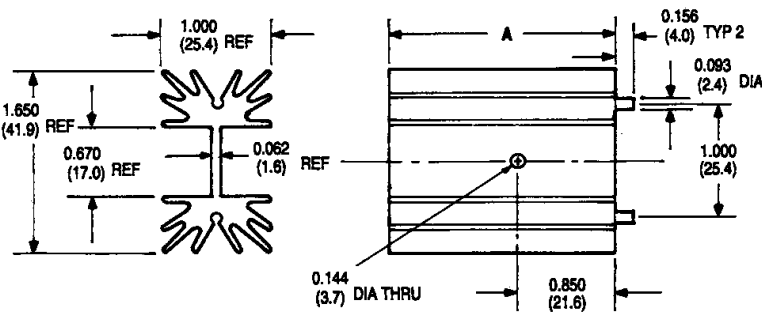

NATURAL AND FORCED CONVECTION CHARACTERISTICS

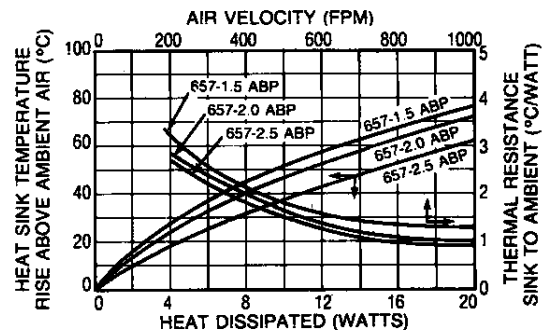

Dimensions: in. (mm)

657 SERIES
(EXTRUSION PROFILE 6533)

BOARD LEVEL POWER SEMICONDUCTOR HEAT SINKS

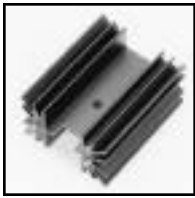

657 SERIES High-Performance Notched Heat Sinks for Vertical Board Mounting

TO-220, TO-247, TO-218

| Standard P/N | Height Above PC Board "A" in. (mm) | Maximum Footprint in. (mm) | Thermal Performance at Typical Load | |
|--------------|------------------------------------|-----------------------------|-------------------------------------|-------------------|
| | | | Natural Convection | Forced Convection |
| 657-10ABPN | 1.000 (25.4) | 1.650 (41.9) x 1.000 (25.4) | 41°C @ 6W | 3.7°C/W @ 200 LFM |
| 657-15ABPN ▲ | 1.500 (38.1) | 1.650 (41.9) x 1.000 (25.4) | 38°C @ 6W | 3.3°C/W @ 200 LFM |
| 657-20ABPN | 2.000 (50.8) | 1.650 (41.9) x 1.000 (25.4) | 32°C @ 6W | 2.9°C/W @ 200 LFM |
| 657-25ABPN | 2.500 (63.5) | 1.650 (41.9) x 1.000 (25.4) | 25°C @ 6W | 2.7°C/W @ 200 LFM |

Wave-solderable pins. Material: Aluminum, Black Anodized

MECHANICAL DIMENSIONS

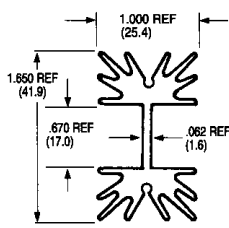

Dimensions: in. (mm)

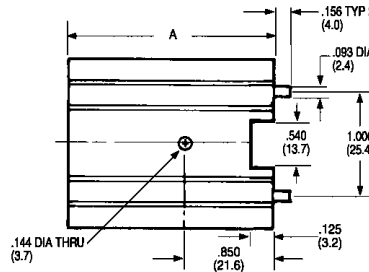

657 SERIES

657 SERIES (EXTRUSION PROFILE 6533)

NATURAL AND FORCED CONVECTION CHARACTERISTICS

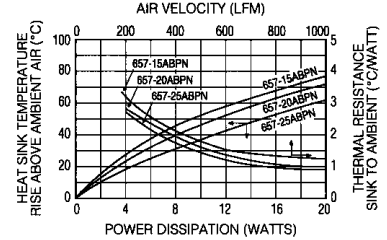

657 SERIES High-Performance Heat Sinks with SpeedClips™ for Vertical Board Mounting

TO-220, TO-247, TO-218

| Standard P/N | Height Above PC Board "A" in. (mm) | Maximum Footprint in. (mm) | Thermal Performance at Typical Load | |
|---------------|------------------------------------|-----------------------------|-------------------------------------|-------------------|
| | | | Natural Convection | Forced Convection |
| 657-10ABPSC | 1.000 (25.4) | 1.650 (41.9) x 1.000 (25.4) | 41°C @ 6W | 3.7°C/W @ 200 LFM |
| 657-15ABPSC | 1.500 (38.1) | 1.650 (41.9) x 1.000 (25.4) | 38°C @ 6W | 3.3°C/W @ 200 LFM |
| 657-20ABPSC | 2.000 (50.8) | 1.650 (41.9) x 1.000 (25.4) | 32°C @ 6W | 2.9°C/W @ 200 LFM |
| 657-25ABPSC ▲ | 2.500 (63.5) | 1.650 (41.9) x 1.000 (25.4) | 25°C @ 6W | 2.7°C/W @ 200 LFM |

Wave-solderable pins. Material: Aluminum, Black Anodized

MECHANICAL DIMENSIONS

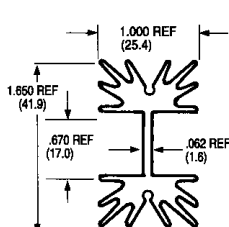

Dimensions: in. (mm)

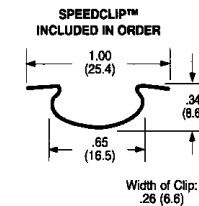
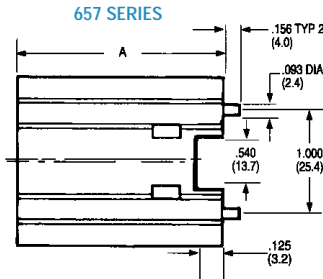

657 SERIES (EXTRUSION PROFILE 6533)

NATURAL AND FORCED CONVECTION CHARACTERISTICS

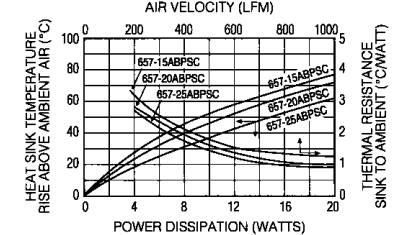

677 SERIES High-Performance, High-Power Heat Sinks for Vertical Board Mounting

TO-218, TO-220, TO-247
15-LEAD Multiwatt

| Standard P/N | Height Above PC Board "A" in. (mm) | Maximum Footprint in. (mm) | Thermal Performance at Typical Load | |
|--------------|------------------------------------|-----------------------------|-------------------------------------|-------------------|
| | | | Natural Convection | Forced Convection |
| 677-10ABP | 1.000 (25.4) | 1.650 (41.9) x 1.000 (25.4) | 52°C @ 6W | 3.1°C/W @ 200 LFM |
| 677-15ABP | 1.500 (38.1) | 1.650 (41.9) x 1.000 (25.4) | 46°C @ 6W | 2.8°C/W @ 200 LFM |
| 677-20ABP | 2.000 (50.8) | 1.650 (41.9) x 1.000 (25.4) | 40°C @ 6W | 2.5°C/W @ 200 LFM |
| 677-25ABP | 2.500 (63.5) | 1.650 (41.9) x 1.000 (25.4) | 35°C @ 6W | 2.2°C/W @ 200 LFM |

Wave-solderable pins. Material: Aluminum, Black Anodized

MECHANICAL DIMENSIONS

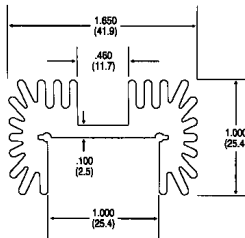

Dimensions: in. (mm)

677 SERIES

677 SERIES (EXTRUSION PROFILE 8719)

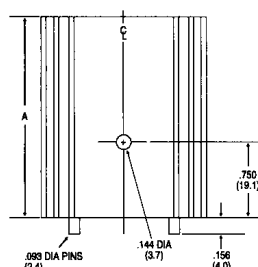

NATURAL AND FORCED CONVECTION CHARACTERISTICS

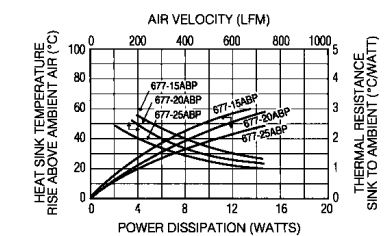

BOARD LEVEL POWER SEMICONDUCTOR HEAT SINKS



690 SERIES Highest Efficiency/Lowest Unit Cost Heat Sinks

TO-3, TO-66, TO-220

| Standard P/N | Height Above PC Board in. (mm) | Outline Dimensions in. (mm) | Thermal Performance at Typical Load | | Semiconductor Mounting Hole Pattern | Weight lbs. (grams) |
|--------------|--------------------------------|-----------------------------|-------------------------------------|-------------------|-------------------------------------|---------------------|
| | | | Natural Convection | Forced Convection | | |
| 690-3B ▲ | 1.310 (33.3) | 1.860 (47.2)-sq | 44°C @ 7.5W | 2.0°C/W @ 400 LFM | (1) TO-3 | 0.0700 (31.75) |
| 690-66B | 1.310 (33.3) | 1.860 (47.2)-sq | 44°C @ 7.5W | 2.0°C/W @ 400 LFM | (1) TO-66 | 0.0700 (31.75) |
| 690-220B | 1.310 (33.3) | 1.860 (47.2)-sq | 44°C @ 7.5W | 2.0°C/W @ 400 LFM | (2) TO-220 | 0.0700 (31.75) |

Material: Aluminum, Black Anodized

These low-cost heat sinks provide the most power dissipation at the lowest unit cost and are available in three standard types to mount and cool one TO-3 or TO-66 metal power semiconductor type or two plastic package TO-220 power semiconductor types. For higher power

semiconductors, the 690 Series can dissipate up to 20 watts while maintaining a mounting surface temperature rise above ambient air temperature of no more than 91°C.

MECHANICAL DIMENSIONS

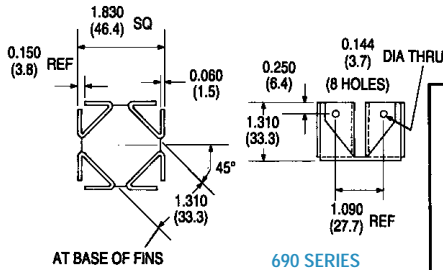

SEMICONDUCTOR MOUNTING HOLES

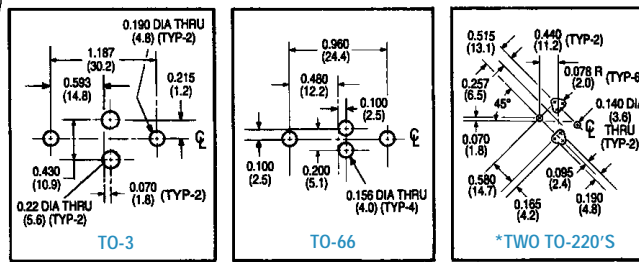

NATURAL AND FORCED CONVECTION CHARACTERISTICS

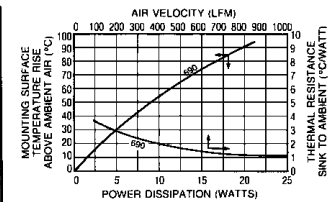

Dimensions: in. (mm)



680 SERIES Maximum Efficiency Omnidirectional Heat Sinks

TO-3, TO-220

| Standard P/N | Height Above PC Board "A" in. (mm) | Horizontal Mounting Footprint Dimensions in. (mm) | Thermal Performance at Typical Load | | Semiconductor Mounting Hole Pattern | Weight lbs. (grams) |
|--------------|------------------------------------|---|-------------------------------------|-------------------|-------------------------------------|---------------------|
| | | | Natural Convection | Forced Convection | | |
| 680-5A ▲ | 0.500 (12.7) | 1.810 (46.0)-sq | 70°C @ 7.5W | 3.0°C/W @ 400 LFM | (1) TO-3 | 0.0700 (31.75) |
| 680-75A ▲ | 0.750 (19.1) | 1.810 (46.0)-sq | 58°C @ 7.5W | 2.4°C/W @ 400 LFM | (1) TO-3 | 0.0900 (40.82) |
| 680-10A ▲ | 1.000 (25.4) | 1.810 (46.0)-sq | 52°C @ 7.5W | 2.0°C/W @ 400 LFM | (1) TO-3 | 0.0980 (44.45) |
| 680-125A ▲ | 1.250 (31.8) | 1.810 (46.0)-sq | 45°C @ 7.5W | 1.5°C/W @ 400 LFM | (1) TO-3 | 0.1100 (49.90) |
| 680-5220 | 0.500 (12.7) | 1.810 (46.0)-sq | 70°C @ 7.5W | 3.0°C/W @ 400 LFM | (2) TO-220 | 0.0700 (31.75) |
| 680-75220 | 0.750 (19.1) | 1.810 (46.0)-sq | 58°C @ 7.5W | 2.4°C/W @ 400 LFM | (2) TO-220 | 0.0900 (40.82) |
| 680-10220 ▲ | 1.000 (25.4) | 1.810 (46.0)-sq | 52°C @ 7.5W | 2.0°C/W @ 400 LFM | (2) TO-220 | 0.0980 (44.45) |
| 680-125220 ▲ | 1.250 (31.8) | 1.810 (46.0)-sq | 45°C @ 7.5W | 1.5°C/W @ 400 LFM | (2) TO-220 | 0.1100 (49.90) |

Material: Aluminum, Black Anodized

Achieve optimum natural convection cooling per unit volume occupied above the printed circuit board for TO-3 (one semiconductor package per heat sink) or for two TO-220 style cases, when this low-cost heat sink is used. Any mounting attitude will provide free circulation

of air in natural convection applications. These 680 Series heat sinks can also be specified without any semiconductor mounting hole pattern by specifying suffix "K" (Example: 680-5K).

MECHANICAL DIMENSIONS

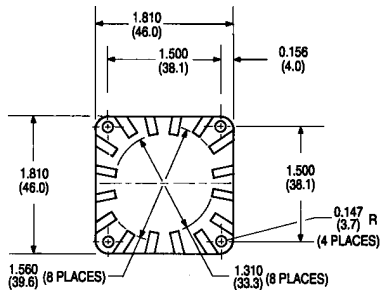

680 SERIES

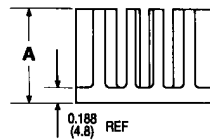

NATURAL AND FORCED CONVECTION CHARACTERISTICS

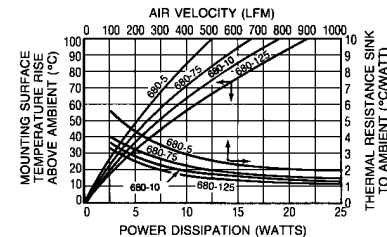

Dimensions: in. (mm)

SEMICONDUCTOR MOUNTING HOLES

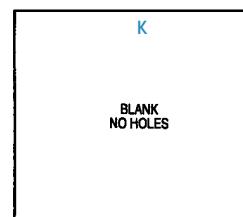
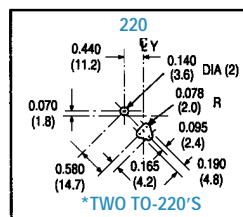
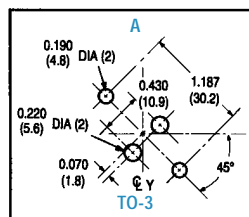

*Only one hole pattern of two is shown. Hole patterns are symmetrical about the center lines.

BOARD LEVEL POWER SEMICONDUCTOR HEAT SINKS



601 AND 603 SERIES Low-Height Heat Sinks

DO-4/DO-5 Diodes

| Standard P/N | Footprint Dimensions in. (mm) | Height in. (mm) | Mounting Hole Dia. in. (mm) | Thermal Performance at Typical Load | | Weight lbs. (grams) |
|--------------|-------------------------------|-----------------|-----------------------------|-------------------------------------|-------------------|---------------------|
| | | | | Natural Convection | Forced Convection | |
| 601E | 2.000 (50.8) x 1.250 (31.8) | 0.562 (14.3) | 0.200 (5.1) | 52°C @ 5.0W | 4.5°C/W @ 175 LFM | 0.0500 (22.68) |
| 601F | 2.000 (50.8) x 1.250 (31.8) | 0.562 (14.3) | 0.270 (6.9) | 52°C @ 5.0W | 4.5°C/W @ 175 LFM | 0.0500 (22.68) |
| 601K | 2.000 (50.8) x 1.250 (31.8) | 0.562 (14.3) | None | 52°C @ 5.0W | 4.5°C/W @ 175 LFM | 0.0500 (22.68) |
| 603K | 2.000 (50.8) x 2.000 (50.8) | 0.562 (14.3) | None | 41°C @ 5.0W | 4.0°C/W @ 175 LFM | 0.0810 (36.74) |

Material: Aluminum Alloy, Black Anodized

Use these low-height heat sinks on printed circuit board applications for TO-66 power semiconductors and DO-4 and DO-5 diodes, where close board-to-board spacing and efficient

heat dissipation are required. The 601 and 603 Series may also be attached to enclosure panels or brackets using isolation hardware where necessary.

MECHANICAL DIMENSIONS

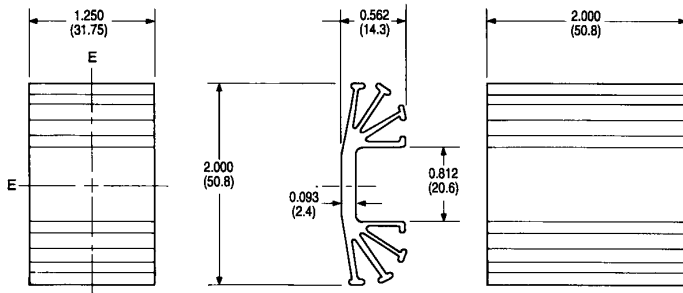

601 SERIES (EXTRUSION PROFILE 1284)

603 SERIES (EXTRUSION PROFILE 1284)

SEMICONDUCTOR MOUNTING HOLES

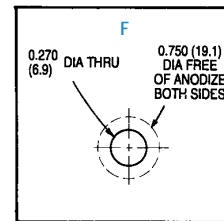
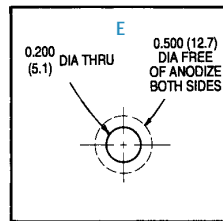
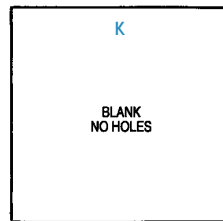

Dimensions: in. (mm)

E&F available on 601 Series only as a standard product.

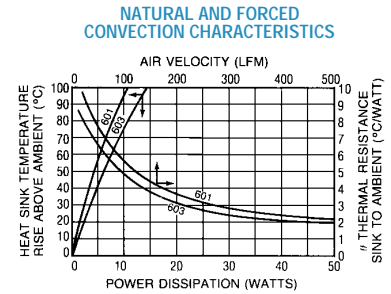

635 SERIES Space-Saving Low-Cost Heat Sinks

TO-3

| Standard P/N | Height Above PC Board "A" in. (mm) | Outline Dimensions in. (mm) | Thermal Performance at Typical Load | | Semiconductor Mounting Hole Pattern | Weight lbs. (grams) |
|--------------|------------------------------------|-----------------------------|-------------------------------------|-------------------|-------------------------------------|---------------------|
| | | | Natural Convection | Forced Convection | | |
| 635-5B2 | 0.500 (12.7) | 1.900 (48.3) x 1.420 (36.0) | 90°C @ 8.0W | 6.0°C/W @ 300 LFM | TO-3 | 0.0200 (9.07) |
| 635-75B2 | 0.750 (19.1) | 1.900 (48.3) x 1.420 (36.0) | 77°C @ 8.0W | 4.8°C/W @ 300 LFM | TO-3 | 0.0220 (9.98) |
| 635-10B2 | 1.000 (25.4) | 1.900 (48.3) x 1.420 (36.0) | 61°C @ 8.0W | 3.6°C/W @ 300 LFM | TO-3 | 0.024 (10.89) |
| 635-125B2 | 1.250 (31.8) | 1.900 (48.3) x 1.420 (36.0) | 53°C @ 8.0W | 3.1°C/W @ 300 LFM | TO-3 | 0.028 (12.70) |

Material: Aluminum Alloy, Black Anodized

Use this low-cost TO-3 heat sink style for multiple TO-3 applications on a single printed circuit board, where two or more TO-3s must be placed in proximity and minimum space is

available for heat sinking. Four different heights are available, all with TO-3 mounting hole pattern in the base. Consult factory for TO-66, TO-220, and multilead IC hole patterns.

MECHANICAL DIMENSIONS

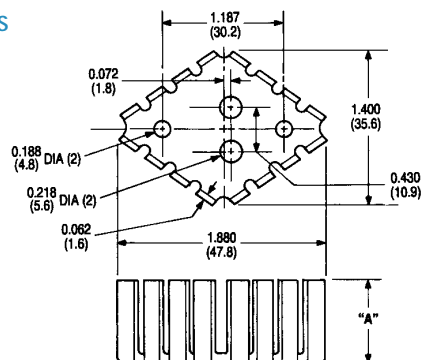

635 SERIES

Dimensions: in. (mm)

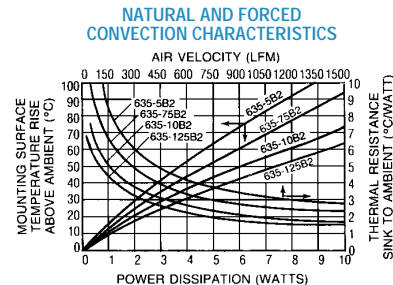

Компания «Life Electronics» занимается поставками электронных компонентов импортного и отечественного производства от производителей и со складов крупных дистрибьюторов Европы, Америки и Азии.

С конца 2013 года компания активно расширяет линейку поставок компонентов по направлению коаксиальный кабель, кварцевые генераторы и конденсаторы (керамические, пленочные, электролитические), за счёт заключения дистрибьюторских договоров

Мы предлагаем:

- Конкурентоспособные цены и скидки постоянным клиентам.
- Специальные условия для постоянных клиентов.
- Подбор аналогов.
- Поставку компонентов в любых объемах, удовлетворяющих вашим потребностям.
- Приемлемые сроки поставки, возможна ускоренная поставка.
- Доставку товара в любую точку России и стран СНГ.
- Комплексную поставку.
- Работу по проектам и поставку образцов.
- Формирование склада под заказчика.
- Сертификаты соответствия на поставляемую продукцию (по желанию клиента).
- Тестирование поставляемой продукции.
- Поставку компонентов, требующих военную и космическую приемку.
- Входной контроль качества.
- Наличие сертификата ISO.

В составе нашей компании организован Конструкторский отдел, призванный помогать разработчикам, и инженерам.

Конструкторский отдел помогает осуществить:

- Регистрацию проекта у производителя компонентов.
- Техническую поддержку проекта.
- Защиту от снятия компонента с производства.
- Оценку стоимости проекта по компонентам.
- Изготовление тестовой платы монтаж и пусконаладочные работы.



Тел: +7 (812) 336 43 04 (многоканальный)

Email: org@lifeelectronics.ru