

Keywords: Cupertino, MAXREFDES5#, subsystem reference design, analog front end, AFE, industrial sensors, isolated power and data, industrial automation, PLC, medical, MAXREFDESS#, MAXREFDE55#, MAXREFDESS, MAXREFDE55, isolation

REFERENCE DESIGN 5561 INCLUDES: ✓Tested Circuit ✓Schematic ✓BOM ✓Board Available ✓Description ✓Test Data ✓Software ✓Layout  
**Cupertino (MAXREFDES5#): 16-Bit High Accuracy Multi-Input Isolated Analog Front End (AFE)**

Jan 11, 2013

*Abstract: This document explains how the Cupertino (MAXREFDES5#) subsystem reference design meets the higher resolution, higher voltage, and isolation needs of industrial control and industrial automation applications. Hardware and firmware design files as well as FFTs and histograms from lab measurements are provided.*

### Introduction

Today's field programmable gate arrays (FPGAs) and microcontrollers with internal analog-to-digital converters (ADCs) are capable of low-resolution and low-voltage analog inputs. However, they fall short on being able to meet the needs of industrial control and industrial automation applications, where isolation, higher resolutions, and higher voltage system solutions are often needed. The Cupertino (MAXREFDES5#) subsystem reference design is a 16-bit high-accuracy industrial analog front end (AFE) that accepts -10V to +10V, 0 to 10V, and 4–20mA current loop signals with isolated power and data integrated into a small form factor. The Cupertino design integrates low-noise high-impedance analog buffers (MAX9632); a highly accurate ADC with innovative on-chip attenuation (MAX1301); an ultra-high precision 4.096V voltage reference (MAX6126); 600V<sub>RMS</sub> data isolation (MAX14850); and isolated/regulated +12V, -12V, and 5V power rails (MAX256/MAX1659). This AFE solution can be used in any application that needs high-accuracy analog-to-digital conversion, but it is mainly targeted for industrial sensors, industrial automation, process control, programmable logic controllers (PLCs), and medical applications.

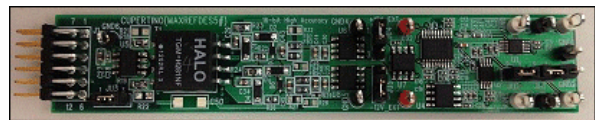

More detailed image (JPG)

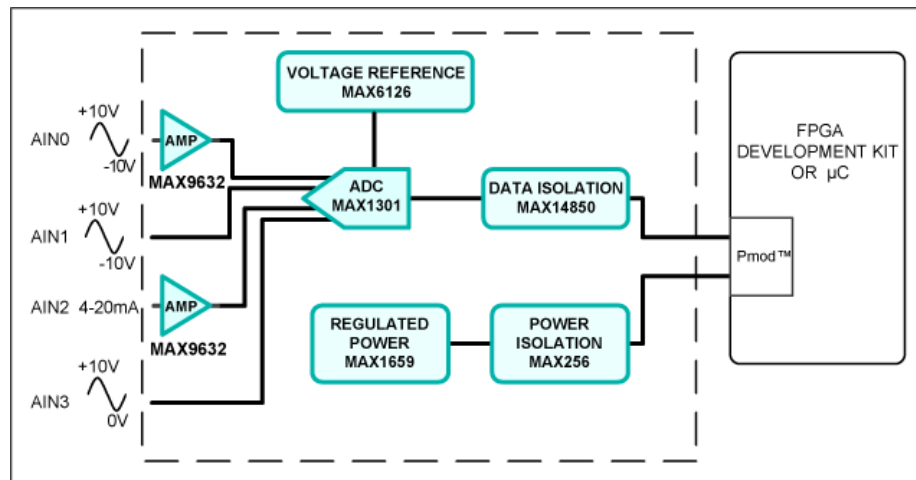

Figure 1. The Cupertino subsystem design block diagram.

### Features

- High accuracy
- ±10V, 0 to 10V, and 4–20mA Inputs
- Isolated power and data
- Small printed-circuit board (PCB) area
- Pmod™-compatible form factor

### Applications

- Industrial sensors
- Process control
- Industrial automation
- PLCs
- Medical

## Detailed Description of Hardware

The Pmod specification allows for both 3.3V and 5V modules as well as various pin assignments. This module is designed only for a supply voltage of 3.3V and uses the SPI pin assignments as illustrated on the right.

The power requirements are shown in **Table 1**. The currently supported platforms and ports are shown in **Table 2**.

Power Type	Jumper Shunt	Input Voltage (V)	Input Current (mA, typ)
On-board isolated power	JU3: 1-2 JU4: 2-3 JU5: 1-2	3.3	221
External power	JU3: 2-3 JU4: 1-2 JU5: 2-3	3.3	6.3
		+12	30.4
		-12	7.3

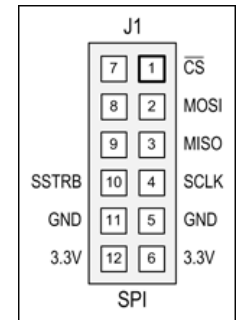

Supported Platforms	Ports
Nexys™ 3 Platform (Spartan®-6)	JB1

The Cupertino hardware design is specifically optimized for applications that use -10V to +10V, 0 to 10V, and 4–20mA signals. Depending on the application requirements, certain portions of the circuit may be omitted. A complete discussion of what portions are needed or may be omitted follows. See the file for the schematic under the [All Design Files](#) section.

The MAX1301 (U3) is a 16-bit, successive-approximation register (SAR) ADC with unique multirange inputs capable of accepting input voltage signals up to +12.288V to -12.288V. The ADC also has integrated analog input buffers with a 17kΩ input resistance.

The first MAX9632 amplifier (U1) is optimized for low-noise, -10V to +10V input voltages. The second MAX9632 amplifier (U2) is optimized for low-noise, 4–20mA input currents. Both U1 and U2 provide high input impedance for input signals that have a large source resistance, or in the case of the 4–20mA loop, a 250Ω load resistance. Large source resistances often attenuate signals by an undesirable factor.

If the signal source has a significantly low source resistance compared to 17kΩ, or in the case of the 4–20mA loop, if the parallel combination of 250Ω and 17kΩ provides acceptable accuracy in the application, then U1 and U2 can be eliminated. ADC channels AIN1 and AIN3 are examples of using only the internal 17kΩ analog input buffers.

Although the MAX1301 ADC has an internal 4.096V voltage reference, for highest accuracy use the external MAX6126 (U4) voltage reference with 0.02% initial accuracy and a 3ppm/°C maximum temperature coefficient (tempco).

The MAX256 (U5) provides an isolated, functional insulation class power solution that accepts 3.3V and converts it to ±12V using an off-the-shelf TGM-H281NF Halo® transformer with a 1:2.6 primary to secondary turns ratio plus an external on-board voltage-doubler circuit. Post-regulation is accomplished using the MAX1659 low dropout (LDO) regulators. The ±12V isolated power solution is optional and is only needed for applications that require the MAX9632 amplifiers to provide a high input impedance or when power isolation is required. If the MAX9632 amplifiers are not needed, then a single +6V isolated supply can power the entire circuit. Data isolation is also optional depending on the application and is accomplished using the MAX14850 (U9) digital data isolator. The combined power and data isolation achieved is 600V<sub>RMS</sub>.

## Detailed Description of Firmware

The Cupertino firmware design was initially released for the Nexys 3 development kit and targeted a MicroBlaze™ soft core microcontroller placed inside a Xilinx® Spartan-6 FPGA. Support for additional platforms may be added periodically under [Firmware Files](#) in the [All Design Files](#) section. The currently supported platforms and ports are shown in **Table 2**.

The firmware is a working example of how to interface to the hardware, collect samples, and save them to memory. The simple process flow is shown in **Figure 2**. The firmware is written in C using the Xilinx SDK tool, which is based on the Eclipse™ open source standard. Custom Cupertino-specific design functions were created utilizing the standard Xilinx XSpi core version 3.03a. The SPI clock frequency is set to 3.125MHz.

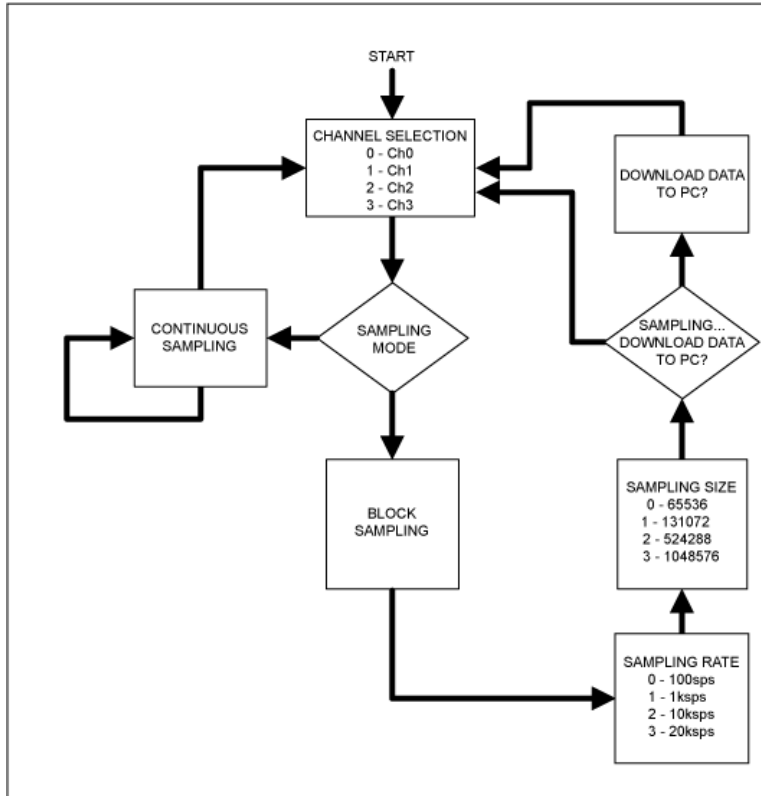

Figure 2. The Cupertino firmware flowchart.

The firmware accepts commands, writes status, and is capable of downloading blocks of sampled data to a standard terminal program via a virtual COM port. The complete source code is provided to speed up customer development. Code documentation can be found in the corresponding firmware platform files.

## Quick Start

Required equipment:

- Windows® PC with two USB ports
- Cupertino (MAXREFDES5#) board
- Cupertino-supported platform (i.e., Nexys 3 development kit)
- Industrial sensor or signal source

Download, read, and carefully follow each step in the [Cupertino \(MAXREFDES5#\) Nexys 3 Quick Start Guide](#).

## Lab Measurements

Equipment used:

- Audio Precision® SYS-2722 signal source or equivalent
- Windows PC with two USB ports
- Cupertino (MAXREFDES5#) board
- Nexys 3 development kit
- +12V power supply (for external power testing only)
- -12V power supply (for external power testing only)

Special care must be taken and the proper equipment must be used when testing the Cupertino design. The key to testing any high-accuracy design is to use sources and measurement equipment that are of higher accuracy than the design under test. A low distortion signal source is absolutely required in order to duplicate the results presented below. The input signal was generated using the Audio Precision SYS-2722. The FFTs were created using the FFT control in SignalLab from [Mitov Software](#). **Table 3** provides a quick reference for the AC and DC performance of each channel for both on-board isolated power and external power shown in **Figures 3** through **18**.

**Table 3. Quick Reference Guide for AC Performance (FFTs) or DC Performance (Histograms) in Figures 3 through 18**

Channel	Power Type	Input Type	Test Type	Figure Number
Channel 0 (AIN0)	On-board isolated	±10V, High	AC - FFT	Figure 3
Channel 0 (AIN0)	On-board isolated	±10V, High	DC - histogram	Figure 4
Channel 0 (AIN0)	External	±10V, High	AC - FFT	Figure 5
Channel 0 (AIN0)	External	±10V, High	DC - histogram	Figure 6
Channel 1 (AIN1)	On-board isolated	±10V, 17kΩ	AC - FFT	Figure 7
Channel 1 (AIN1)	On-board isolated	±10V, 17kΩ	DC - histogram	Figure 8
Channel 1 (AIN1)	External	±10V, 17kΩ	AC - FFT	Figure 9
Channel 1 (AIN1)	External	±10V, 17kΩ	DC - histogram	Figure 10
Channel 2 (AIN2)	On-board isolated	4–20mA, 250Ω	AC - FFT	Figure 11
Channel 2 (AIN2)	On-board Isolated	4–20mA, 250Ω	DC - histogram	Figure 12
Channel 2 (AIN2)	External	4–20mA, 250Ω	AC - FFT	Figure 13
Channel 2 (AIN2)	External	4–20mA, 250Ω	DC - histogram	Figure 14
Channel 3 (AIN3)	On-board isolated	0 to 10V, 17kΩ	AC - FFT	Figure 15
Channel 3 (AIN3)	On-board isolated	0 to 10V, 17kΩ	DC - histogram	Figure 16
Channel 3 (AIN3)	External	0 to 10V, 17kΩ	AC - FFT	Figure 17
Channel 3 (AIN3)	External	0 to 10V, 17kΩ	DC - histogram	Figure 18

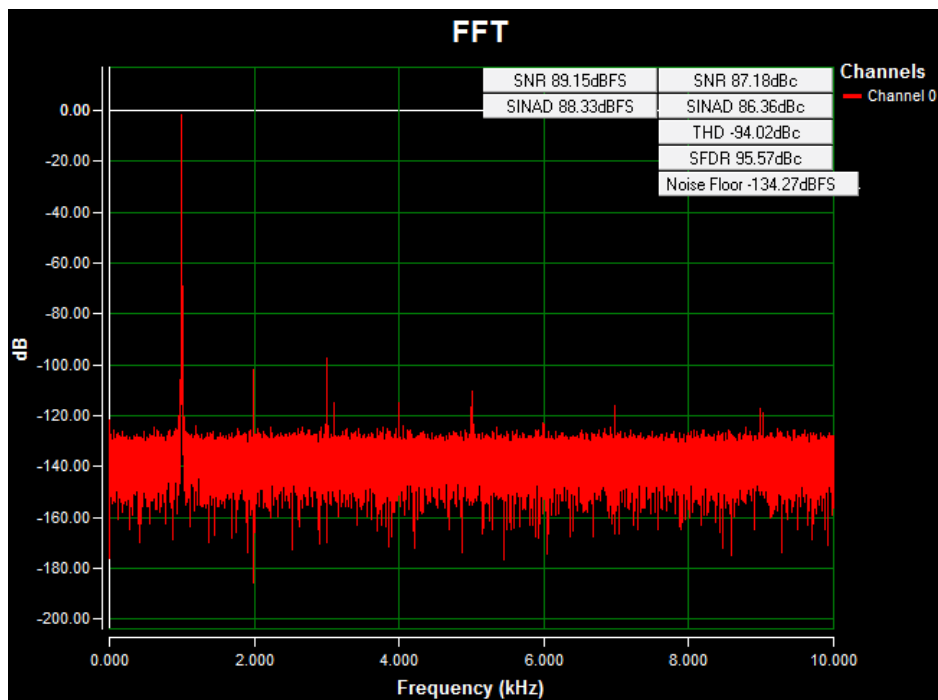

Figure 3. AC FFT for channel 0 (AIN0) using on-board isolated power, a ±10V 1kHz sine wave input signal, high-impedance input, a 20ksps sample rate, and a Blackman-Harris window.

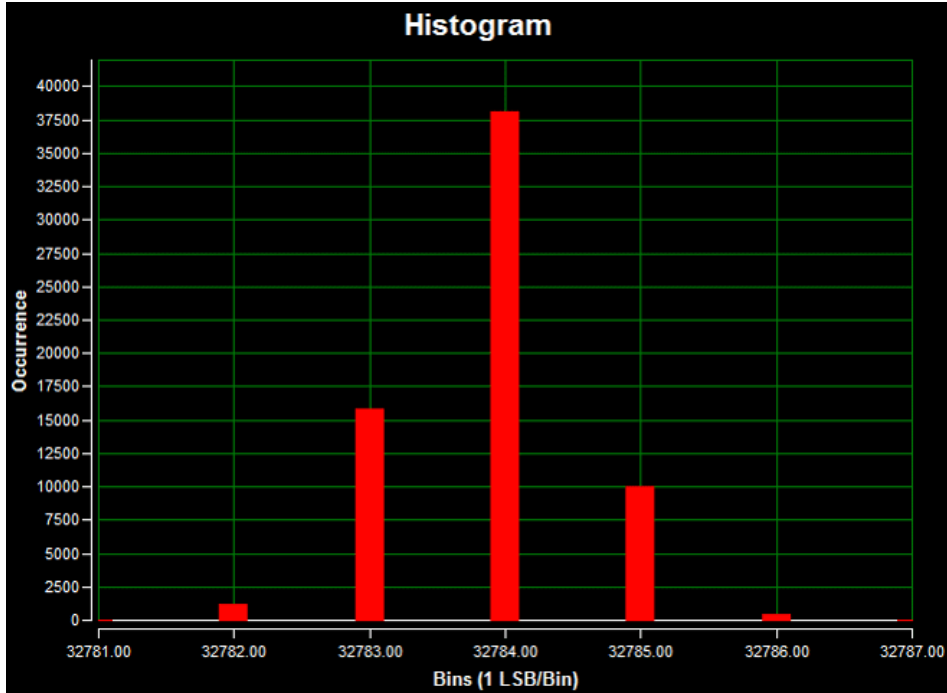

Figure 4. DC histogram for channel 0 (AIN0) using on-board isolated power; a 0V input signal; high-impedance input; a 20ksps sample rate; 65,536 samples; a code spread of 7 LSBs with 97.57% of the codes falling within the three center LSBs; and a standard deviation of 0.693.

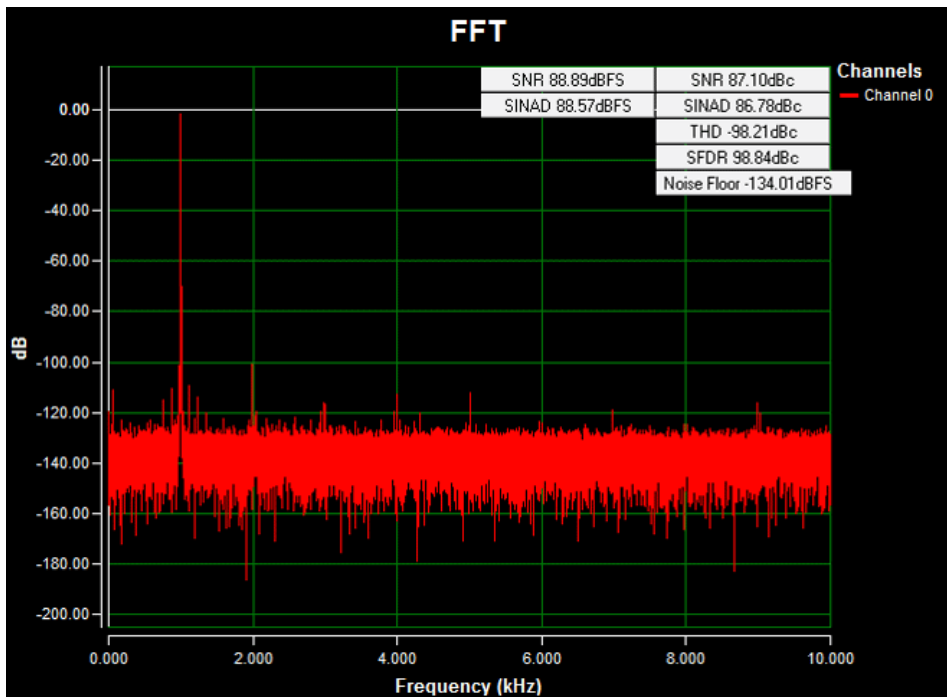

Figure 5. AC FFT for channel 0 (AIN0) using external power, a  $\pm 10V$  1kHz sine wave input signal, high-impedance input, a 20ksps sample rate, and a Blackman-Harris window.

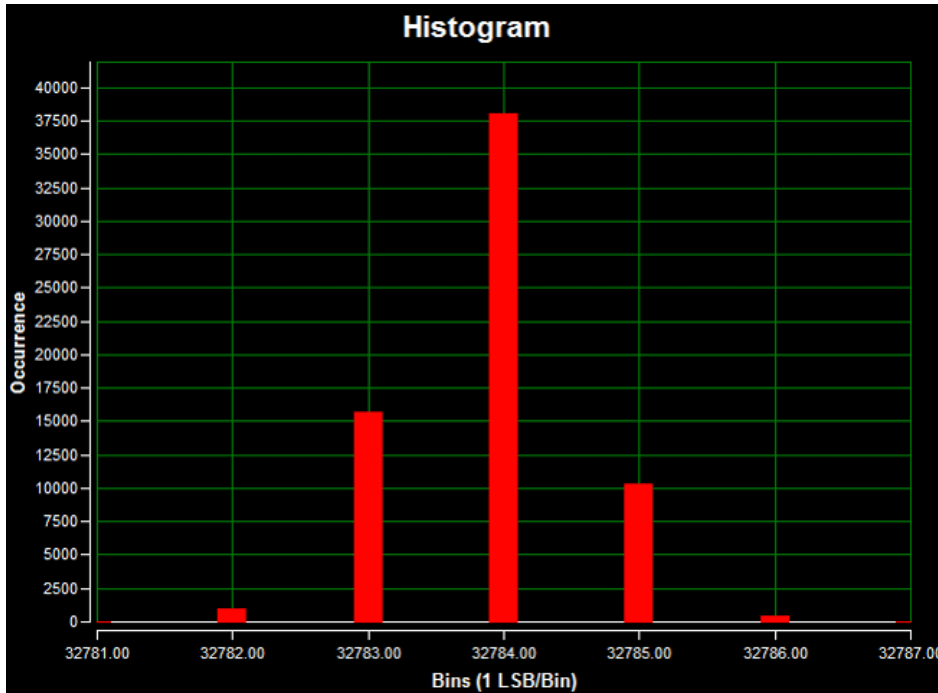

Figure 6. DC histogram for channel 0 (AIN0) using external power; a 0V input signal; high-impedance input; a 20ksps sample rate; 65,536 samples; a code spread of 7 LSBs with 97.74% of the codes falling within the three center LSBs; and a standard deviation of 0.692.

[Figures 7 to 10: Channel 1 \(AIN1\) \(PDF\)](#)

[Figures 11 to 14: Channel 2 \(AIN2\) \(PDF\)](#)

[Figures 15 to 18: Channel 3 \(AIN3\) \(PDF\)](#)

## All Design Files

[Download all design files.](#)

### Hardware Files

[Schematic](#)  
[Bill of materials \(BOM\)](#)  
[PCB layout](#)  
[PCB Gerber](#)  
[PCB CAD \(PADS 9.0\)](#)

### Firmware Files

[Nexys 3 platform \(Spartan-6\)](#)

## Buy Reference Design

[Cupertino \(MAXREFDES5#\)](#)

Audio Precision is a registered trademark of Audio Precision, Inc.  
 Eclipse is a trademark of Eclipse Foundation, Inc.  
 Halo is a registered trademark of Halo Electronics, Inc.  
 MicroBlaze is a trademark of Xilinx, Inc.  
 Nexys is a trademark of Digilent Inc.  
 Pmod is a trademark of Digilent Inc.  
 Spartan is a registered trademark of Xilinx, Inc.  
 Windows is a registered trademark and registered service mark of Microsoft Corporation.

Xilinx is a registered trademark and registered service mark of Xilinx, Inc.

Related Parts		
<a href="#">MAX1301</a>	8- and 4-Channel, $\pm 3 \times V_{REF}$ Multirange Inputs, Serial 16-Bit ADCs	<a href="#">Free Samples</a>
<a href="#">MAX14850</a>	Six-Channel Digital Isolator	
<a href="#">MAX1659</a>	350mA, 16.5V Input, Low-Dropout Linear Regulators	<a href="#">Free Samples</a>
<a href="#">MAX256</a>	3W Primary-Side Transformer H-Bridge Driver for Isolated Supplies	<a href="#">Free Samples</a>
<a href="#">MAX6126</a>	Ultra-High-Precision, Ultra-Low-Noise, Series Voltage Reference	<a href="#">Free Samples</a>
<a href="#">MAX9632</a>	36V, Precision, Low-Noise, Wide-Band Amplifier	<a href="#">Free Samples</a>
<a href="#">MAXREFDES5</a>	Cupertino (MAXREFDES5#): 16-Bit High Accuracy Multi-Input Isolated Analog Front End (AFE)	

#### More Information

For Technical Support: <http://www.maximintegrated.com/support>

For Samples: <http://www.maximintegrated.com/samples>

Other Questions and Comments: <http://www.maximintegrated.com/contact>

Application Note 5561: <http://www.maximintegrated.com/an5561>

REFERENCE DESIGN 5561, AN5561, AN 5561, APP5561, Appnote5561, Appnote 5561

© 2013 Maxim Integrated Products, Inc.

Additional Legal Notices: <http://www.maximintegrated.com/legal>

Компания «Life Electronics» занимается поставками электронных компонентов импортного и отечественного производства от производителей и со складов крупных дистрибьюторов Европы, Америки и Азии.

С конца 2013 года компания активно расширяет линейку поставок компонентов по направлению коаксиальный кабель, кварцевые генераторы и конденсаторы (керамические, пленочные, электролитические), за счёт заключения дистрибьюторских договоров

Мы предлагаем:

- Конкурентоспособные цены и скидки постоянным клиентам.
- Специальные условия для постоянных клиентов.
- Подбор аналогов.
- Поставку компонентов в любых объемах, удовлетворяющих вашим потребностям.
- Приемлемые сроки поставки, возможна ускоренная поставка.
- Доставку товара в любую точку России и стран СНГ.
- Комплексную поставку.
- Работу по проектам и поставку образцов.
- Формирование склада под заказчика.
- Сертификаты соответствия на поставляемую продукцию (по желанию клиента).
- Тестирование поставляемой продукции.
- Поставку компонентов, требующих военную и космическую приемку.
- Входной контроль качества.
- Наличие сертификата ISO.

В составе нашей компании организован Конструкторский отдел, призванный помогать разработчикам, и инженерам.

Конструкторский отдел помогает осуществить:

- Регистрацию проекта у производителя компонентов.
- Техническую поддержку проекта.
- Защиту от снятия компонента с производства.
- Оценку стоимости проекта по компонентам.
- Изготовление тестовой платы монтаж и пусконаладочные работы.



Тел: +7 (812) 336 43 04 (многоканальный)  
Email: [org@lifeelectronics.ru](mailto:org@lifeelectronics.ru)