

Insulated Single Phase Hyperfast Bridge (Power Modules), 60 A



SOT-227

FEATURES

- Hyperfast and soft recovery characteristic
- Electrically isolated base plate
- Simplified mechanical designs, rapid assembly
- High operation junction temperature (T_J max. = 175 °C)
- Designed and qualified for industrial and consumer level
- UL approved file E78996
- Material categorization: for definitions of compliance please see www.vishay.com/doc?99912

**RoHS
COMPLIANT**

PRIMARY CHARACTERISTICS	
V_{RRM}	650 V
I_O at $T_C = 123$ °C	60 A
t_{tr}	63 ns
Type	Modules - Bridge, Hyperfast
Package	SOT-227
Circuit configuration	Single phase bridge

DESCRIPTION

The semiconductor in the SOT-227 package is isolated from the copper base plate, allowing for common heatsinks and compact assemblies to be built.

ABSOLUTE MAXIMUM RATINGS			
SYMBOL	CHARACTERISTICS	VALUES	UNITS
I_O		60	A
	T_C	123	°C
I_{FSM}	50 Hz	360	A
	60 Hz	377	
I^2t	50 Hz	648	A ² s
	60 Hz	589	
V_{RRM}		650	V
T_J		-55 to +175	°C

ELECTRICAL SPECIFICATIONS

VOLTAGE RATINGS				
TYPE NUMBER	VOLTAGE CODE	V_{RRM} , MAXIMUM REPETITIVE PEAK REVERSE VOLTAGE V	V_{RSM} , MAXIMUM NON-REPETITIVE PEAK REVERSE VOLTAGE V	I_{RRM} MAXIMUM AT T_J MAXIMUM mA
UFH60BA65	65	650	700	2

ELECTRICAL SPECIFICATIONS ($T_J = 25$ °C unless otherwise specified)							
PARAMETER	SYMBOL	TEST CONDITIONS	MIN.	TYP.	MAX.	UNITS	
Cathode to anode breakdown voltage	V_{BR}	$I_R = 250$ μ A	650	-	-	V	
Forward voltage, per diode	V_{FM}	$I_F = 60$ A	-	1.7	2.35		
Reverse leakage current, per leg	I_{RM}	$V_R = 650$ V	-	1.0	100	μ A	
		$V_R = 650$ V, $T_J = 150$ °C	-	250	-		
RMS isolation voltage base plate	V_{ISOL}	$f = 50$ Hz, any terminal to case, $t = 1$ min	2500	-	-	V	



FORWARD CONDUCTION					
PARAMETER	SYMBOL	TEST CONDITIONS		VALUES	UNITS
Maximum DC output current at case temperature	I _o	Resistive or inductive load		60	A
				123	°C
Maximum peak, one-cycle non-repetitive forward current	I _{FSM}	t = 10 ms	No voltage reapplied	Initial T _J = 25 °C	A
		t = 8.3 ms			
		t = 10 ms	100 % V _{RRM} reapplied		
		t = 8.3 ms			
Maximum I ² t for fusing	I ² t	t = 10 ms	No voltage reapplied	Initial T _J = 25 °C	A ² s
		t = 8.3 ms			
		t = 10 ms	100 % V _{RRM} reapplied		
		t = 8.3 ms			
Maximum I ² √t for fusing	I ² √t	I ² t for time t _x = I ₂ √t × √t _x ; 0.1 ≤ t _x ≤ 10 ms, V _{RRM} = 0 V		6.4	kA ² √s
Low level of threshold voltage, per leg	V _{F(T0)1}	(16.7 % × π × I _{F(AV)}) < I < π × I _{F(AV)} , T _J = T _J maximum		16.49	V
Low level value of forward slope resistance	r _{f1}			0.88	mΩ
High level of threshold voltage, per leg	V _{F(T0)2}	(I > π × I _{F(AV)}), T _J = T _J maximum		15.87	V
High level value of forward slope resistance	r _{f2}			1.16	mΩ
Maximum forward voltage, per diode	V _{FM}	I _F = 60 A		2.35	V

RECOVERY CHARACTERISTICS				
PARAMETER	SYMBOL	TEST CONDITIONS	VALUES	UNITS
Typical reverse recovery time, per diode	t _{rr}	T _J = 25 °C, I _F = 50 A, V _R = 200 V, dI _F /dt = 200 A/μs	63	ns
		T _J = 125 °C, I _F = 50 A, V _R = 200 V, dI _F /dt = 200 A/μs	134	
Typical reverse recovery current, per diode	I _{rr}	T _J = 25 °C, I _F = 50 A, V _R = 200 V, dI _F /dt = 200 A/μs	4.1	A
		T _J = 125 °C, I _F = 50 A, V _R = 200 V, dI _F /dt = 200 A/μs	11.4	
Typical reverse recovery charge, per diode	Q _{rr}	T _J = 25 °C, I _F = 50 A, V _R = 200 V, dI _F /dt = 200 A/μs	130	nC
		T _J = 125 °C, I _F = 50 A, V _R = 200 V, dI _F /dt = 200 A/μs	765	
Typical junction capacitance	C _T	V _R = 650 V	77	pF

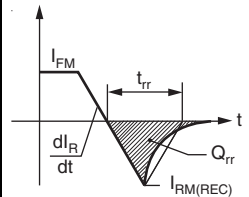

THERMAL AND MECHANICAL SPECIFICATIONS						
PARAMETER	SYMBOL	TEST CONDITIONS	MIN.	TYP.	MAX.	UNITS
Junction and storage temperature range	T _J , T _{Stg}		-55	-	175	°C
Thermal resistance junction to case	R _{thJC}		-	-	0.91	°C/W
Thermal resistance case to heatsink	R _{thCS}	Flat, greased surface	-	0.1	-	
Weight			-	30	-	g
Mounting torque		Torque to terminal	-	-	1.1 (9.7)	Nm (lbf.in)
		Torque to heatsink	-	-	1.3 (11.5)	Nm (lbf.in)
Case style			SOT-227			

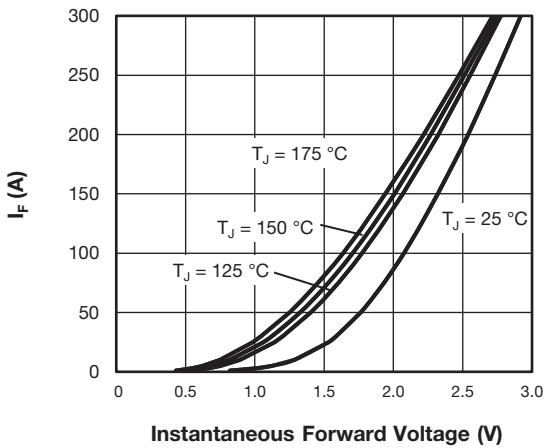

Fig. 1 - Typical Forward Voltage Characteristics

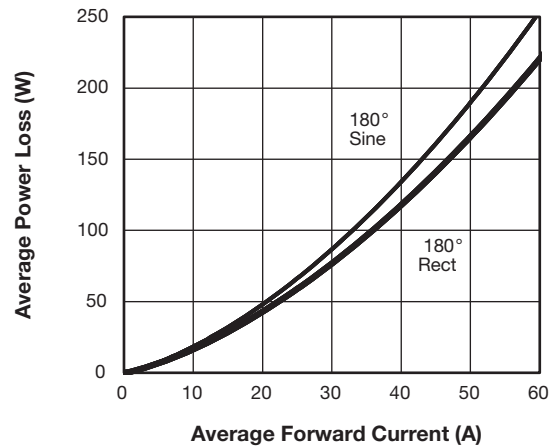

Fig. 4 - Forward Power Loss Characteristics

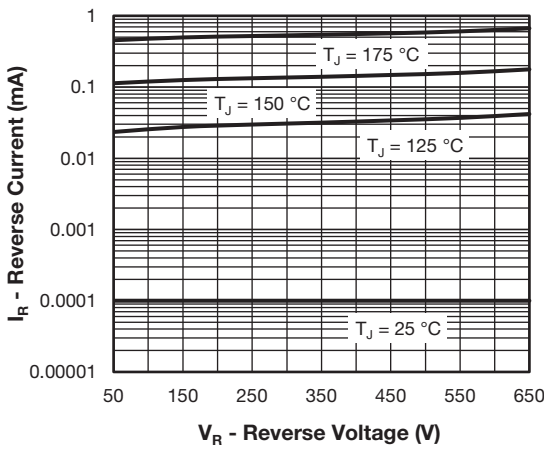

Fig. 2 - Typical Reverse Current vs. Reverse Voltage (Per Diode)

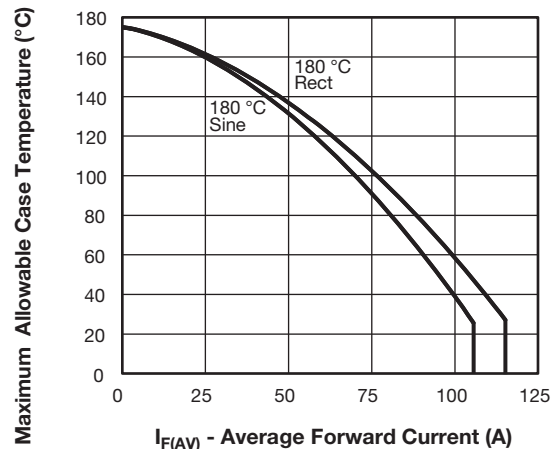

Fig. 5 - Current Rating Characteristics (A)

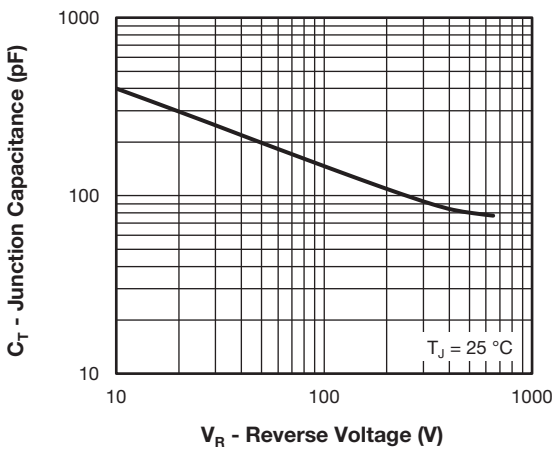

Fig. 3 - Typical Junction Capacitance vs. Reverse Voltage (Per Diode)

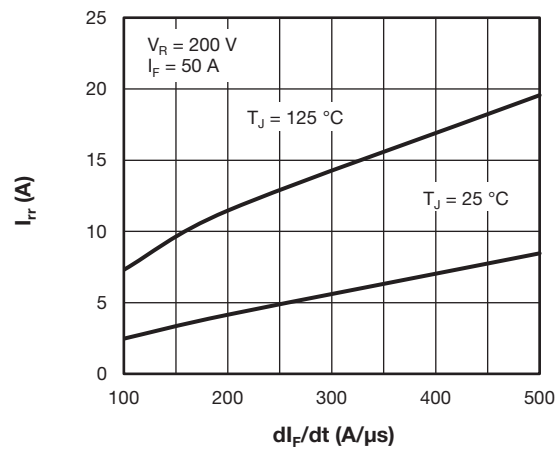

Fig. 6 - Typical Reverse Recovery Current vs. di_F/dt

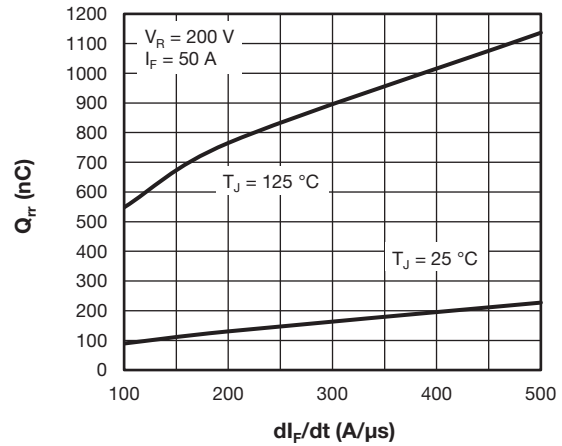
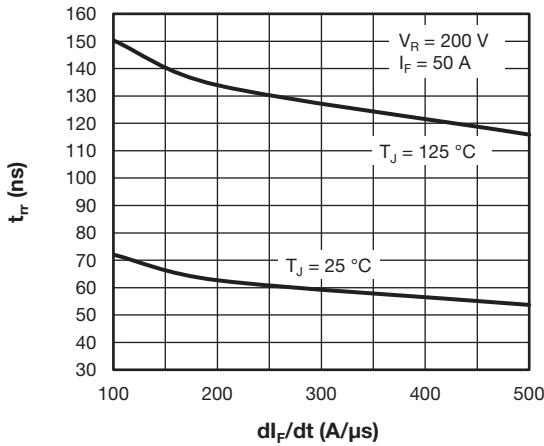

Fig. 7 - Typical Reverse Recovery Time vs. di_F/dt

Fig. 8 - Reverse Recovery Charge vs. di_F/dt

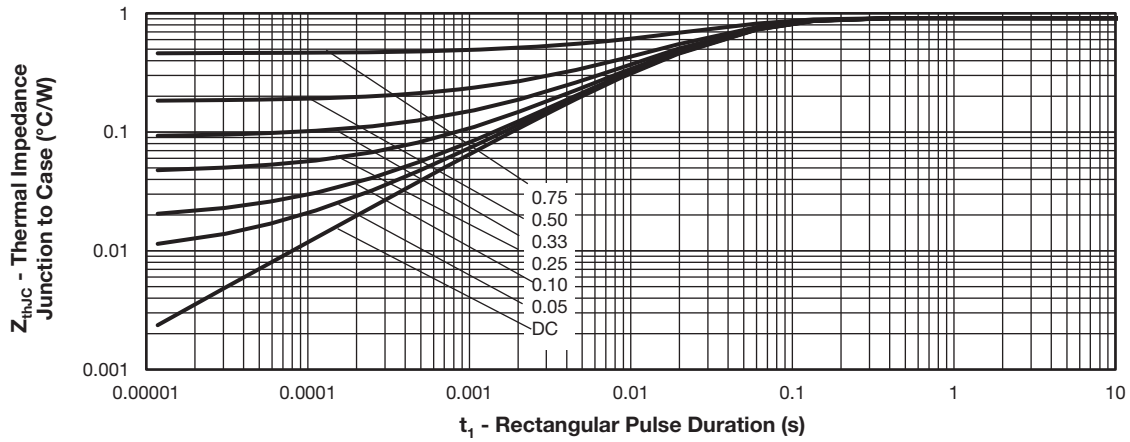
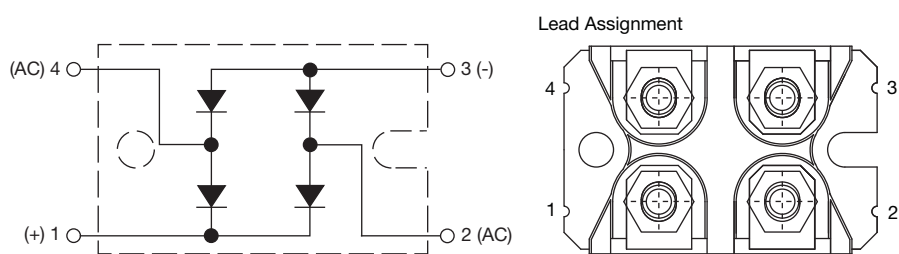

Fig. 9 - Typical Reverse Recovery Current vs. di_F/dt (Per Diode)

ORDERING INFORMATION TABLE

Device code	VS-	UF	H	60	B	A	65
	①	②	③	④	⑤	⑥	⑦

- 1** - Vishay Semiconductors product
- 2** - Ultra fast rectifier
- 3** - Hyper fast FRED Pt[®] diffused
- 4** - Current rating (60 = 60 A)
- 5** - Circuit configuration:
B = Single phase bridge
- 6** - Package indicator:
A = SOT-227, standard insulated base
- 7** - Voltage rating (65 = 650 V)

CIRCUIT CONFIGURATION		
CIRCUIT	CIRCUIT CONFIGURATION CODE	CIRCUIT DRAWING
Single phase bridge	B	

LINKS TO RELATED DOCUMENTS	
Dimensions	www.vishay.com/doc?95423
Packaging information	www.vishay.com/doc?95425



SOT-227 Generation II

DIMENSIONS in millimeters (inches)

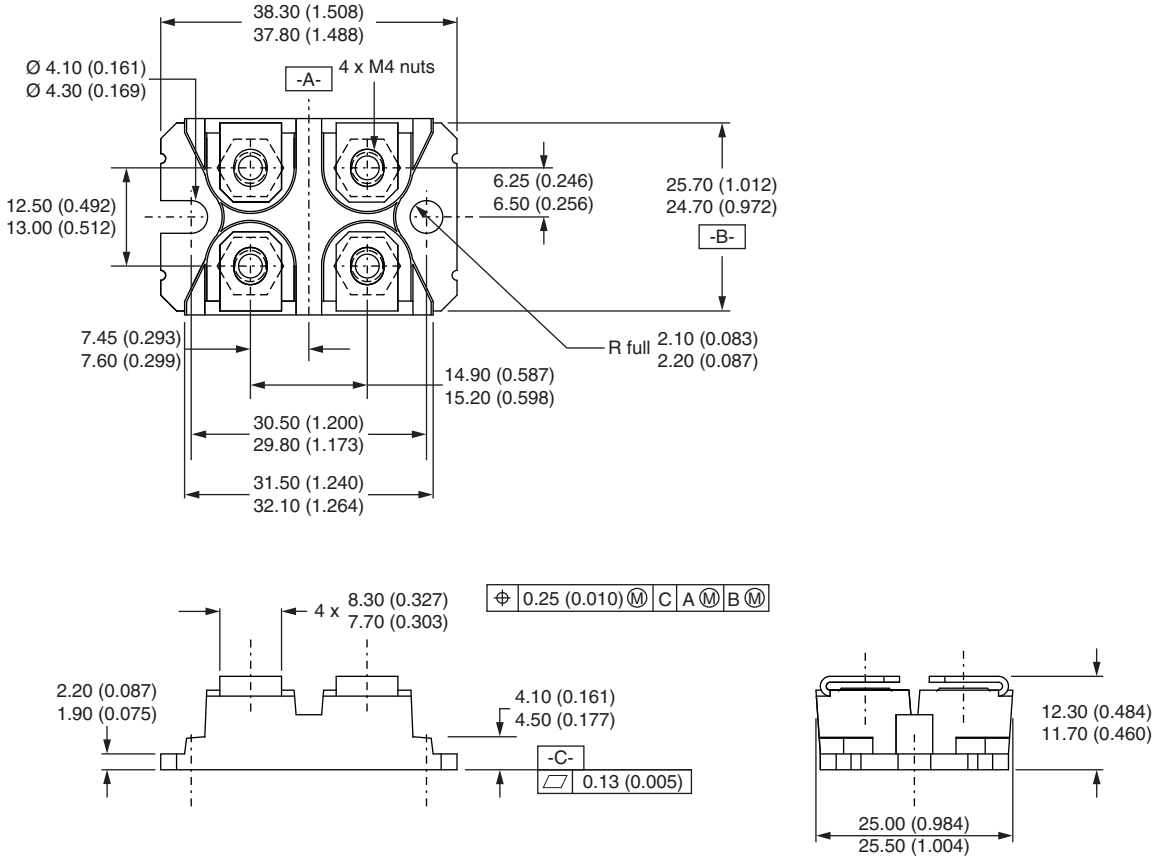

Note

- Controlling dimension: millimeter



Disclaimer

ALL PRODUCT, PRODUCT SPECIFICATIONS AND DATA ARE SUBJECT TO CHANGE WITHOUT NOTICE TO IMPROVE RELIABILITY, FUNCTION OR DESIGN OR OTHERWISE.

Vishay Intertechnology, Inc., its affiliates, agents, and employees, and all persons acting on its or their behalf (collectively, "Vishay"), disclaim any and all liability for any errors, inaccuracies or incompleteness contained in any datasheet or in any other disclosure relating to any product.

Vishay makes no warranty, representation or guarantee regarding the suitability of the products for any particular purpose or the continuing production of any product. To the maximum extent permitted by applicable law, Vishay disclaims (i) any and all liability arising out of the application or use of any product, (ii) any and all liability, including without limitation special, consequential or incidental damages, and (iii) any and all implied warranties, including warranties of fitness for particular purpose, non-infringement and merchantability.

Statements regarding the suitability of products for certain types of applications are based on Vishay's knowledge of typical requirements that are often placed on Vishay products in generic applications. Such statements are not binding statements about the suitability of products for a particular application. It is the customer's responsibility to validate that a particular product with the properties described in the product specification is suitable for use in a particular application. Parameters provided in datasheets and / or specifications may vary in different applications and performance may vary over time. All operating parameters, including typical parameters, must be validated for each customer application by the customer's technical experts. Product specifications do not expand or otherwise modify Vishay's terms and conditions of purchase, including but not limited to the warranty expressed therein.

Except as expressly indicated in writing, Vishay products are not designed for use in medical, life-saving, or life-sustaining applications or for any other application in which the failure of the Vishay product could result in personal injury or death. Customers using or selling Vishay products not expressly indicated for use in such applications do so at their own risk. Please contact authorized Vishay personnel to obtain written terms and conditions regarding products designed for such applications.

No license, express or implied, by estoppel or otherwise, to any intellectual property rights is granted by this document or by any conduct of Vishay. Product names and markings noted herein may be trademarks of their respective owners.

Компания «Life Electronics» занимается поставками электронных компонентов импортного и отечественного производства от производителей и со складов крупных дистрибьюторов Европы, Америки и Азии.

С конца 2013 года компания активно расширяет линейку поставок компонентов по направлению коаксиальный кабель, кварцевые генераторы и конденсаторы (керамические, пленочные, электролитические), за счёт заключения дистрибьюторских договоров

Мы предлагаем:

- Конкурентоспособные цены и скидки постоянным клиентам.
- Специальные условия для постоянных клиентов.
- Подбор аналогов.
- Поставку компонентов в любых объемах, удовлетворяющих вашим потребностям.
- Приемлемые сроки поставки, возможна ускоренная поставка.
- Доставку товара в любую точку России и стран СНГ.
- Комплексную поставку.
- Работу по проектам и поставку образцов.
- Формирование склада под заказчика.
- Сертификаты соответствия на поставляемую продукцию (по желанию клиента).
- Тестирование поставляемой продукции.
- Поставку компонентов, требующих военную и космическую приемку.
- Входной контроль качества.
- Наличие сертификата ISO.

В составе нашей компании организован Конструкторский отдел, призванный помогать разработчикам, и инженерам.

Конструкторский отдел помогает осуществить:

- Регистрацию проекта у производителя компонентов.
- Техническую поддержку проекта.
- Защиту от снятия компонента с производства.
- Оценку стоимости проекта по компонентам.
- Изготовление тестовой платы монтаж и пусконаладочные работы.



Тел: +7 (812) 336 43 04 (многоканальный)

Email: org@lifeelectronics.ru