

**0.5A to 2.0A High-side Power Distribution Switches****AP2822****General Description**

The AP2822 is an integrated high-side power switch that consists of N-Channel MOSFET, charge pump, over current & temperature and other related protection circuits. The switch's low  $R_{DS(ON)}$ , 85m $\Omega$ , is designed to meet USB voltage drop requirements. The IC includes soft-start to limit inrush current, over-current protection, load short protection with fold-back, and thermal shutdown to avoid switch failure during hot plug-in. Under voltage lockout (UVLO) function is used to ensure the device remain off unless there is a valid input voltage present. A FLAG output is available to indicate fault conditions to the local USB controller.

The AP2822 is available in the standard package of SOT-23-5.

**Features**

- Low MOSFET On Resistance: 85m $\Omega$
- Compliant to USB Specifications
- Available 4 Versions of Continuous Load: 0.5A/1.0A/1.5A/2.0A
- Logic Level Enable Pin: Available with Active-high or Active-low Version
- Operating Voltage Range: 2.7V to 5.5V
- Low Supply Current: 68 $\mu$ A (Typ.)
- Low Shutdown Current: 1.0 $\mu$ A (Max)
- Under-voltage Lockout
- Soft Start-up
- Over-current Protection
- Over Temperature Protection
- Load Short Protection with Fold-back
- No Reverse Current When Power Off
- Deglitched FLAG Output with Open Drain
- With Output Shutdown Pull-low Resistor

**Applications**

- USB Power Management
- USB Bus/Self Powered Hubs
- Hot-plug Power Supplies
- Battery-charger Circuits
- Notebooks, Motherboard PCs



Figure 1. Package Type of AP2822

**Pin Configuration**K/KA/KB/KE Package  
(SOT-23-5)

Figure 2. Pin Configuration of AP2822 (Top View)

**0.5A to 2.0A High-side Power Distribution Switches****AP2822****Pin Descriptions**

<b>Pin Number</b>	<b>Pin Name</b>	<b>Function</b>
1(K)	FLAG	Fault flag pin, output with open drain, need a pull-up resistor in application, active low to indicate OCP or OTP
3(KA/KE)		
2	GND	Ground
3(K)	EN	Chip enable control input, active low or high
1(KA)		
4(KB/KE)		
4(K/KA)	VIN	Supply input pin
3(KB)		
5(KE)		
5(K/KA)	VOUT	Switch output voltage
1,5(KB)		
1(KE)		

Functional Block Diagram

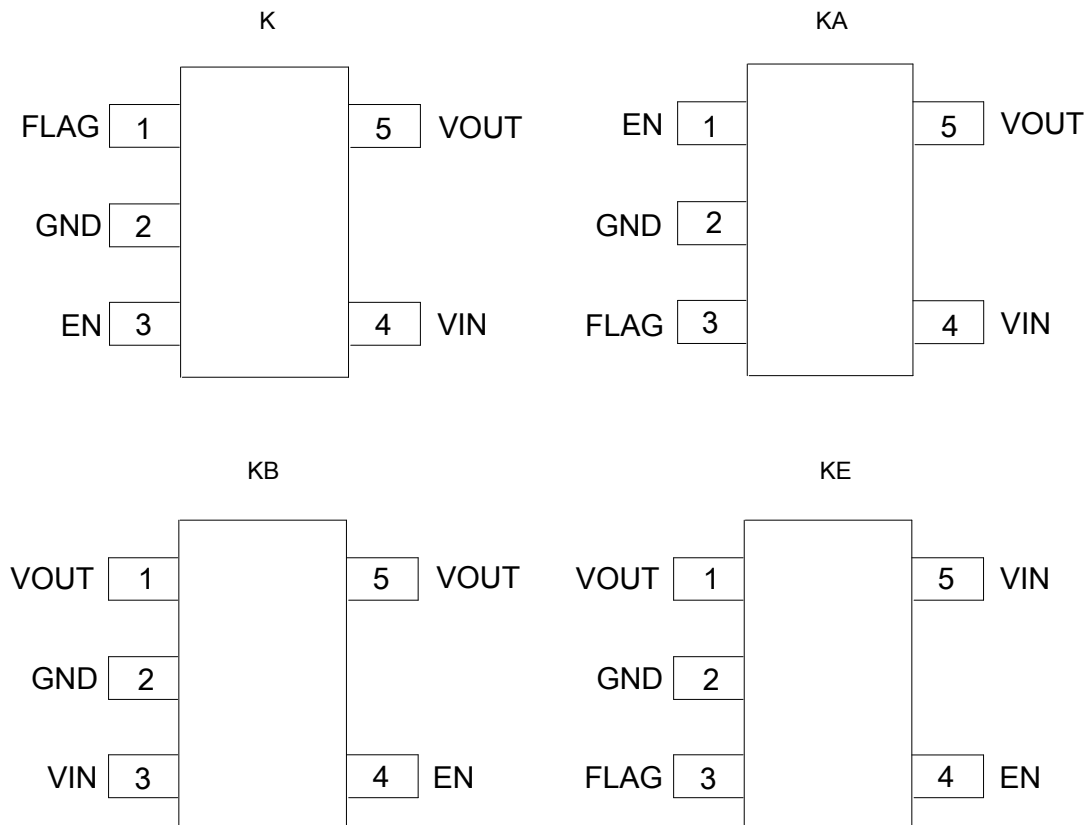

A(B){C}[D]

- A: SOT-23-5(K Package)
- B: SOT-23-5(KA Package)
- C: SOT-23-5(KB Package)
- D: SOT-23-5(KE Package)

Figure 3. Functional Block Diagram of AP2822



**0.5A to 2.0A High-side Power Distribution Switches**

**AP2822**

**Ordering Information**



Package	Temperature Range	Condition	Part Number	Marking ID	Packing Type
SOT-23-5	-40 to 85°C	Active High (Continuous 0.5A)	AP2822AKTR-G1	GCQ	Tape & Reel
		Active Low (Continuous 0.5A)	AP2822BKTR-G1	GCR	Tape & Reel
		Active High (Continuous 1.0A)	AP2822CKTR-G1	GCS	Tape & Reel
		Active Low (Continuous 1.0A)	AP2822DKTR-G1	GCT	Tape & Reel
		Active High (Continuous 1.5A)	AP2822EKTR-G1	GCU	Tape & Reel
		Active Low (Continuous 1.5A)	AP2822FKTR-G1	GCV	Tape & Reel
		Active High (Continuous 2.0A)	AP2822GKTR-G1	GCW	Tape & Reel
		Active Low (Continuous 2.0A)	AP2822HKTR-G1	GCZ	Tape & Reel

**0.5A to 2.0A High-side Power Distribution Switches****AP2822****Ordering Information (Continued)**

Package	Temperature Range	Condition	Part Number	Marking ID	Packing Type
SOT-23-5	-40 to 85°C	Active High (Continuous 0.5A)	AP2822AKATR-G1	GDQ	Tape & Reel
		Active Low (Continuous 0.5A)	AP2822BKATR-G1	GDR	Tape & Reel
		Active High (Continuous 1.0A)	AP2822CKATR-G1	GDS	Tape & Reel
		Active Low (Continuous 1.0A)	AP2822DKATR-G1	GDT	Tape & Reel
		Active High (Continuous 1.5A)	AP2822EKATR-G1	GDU	Tape & Reel
		Active Low (Continuous 1.5A)	AP2822FKATR-G1	GDV	Tape & Reel
		Active High (Continuous 2.0A)	AP2822GKATR-G1	GDW	Tape & Reel
		Active Low (Continuous 2.0A)	AP2822HKATR-G1	GDZ	Tape & Reel
SOT-23-5	-40 to 85°C	Active High (Continuous 0.5A)	AP2822AKBTR-G1	GLA	Tape & Reel
		Active Low (Continuous 0.5A)	AP2822BKBTR-G1	GLB	Tape & Reel
		Active High (Continuous 1.0A)	AP2822CKBTR-G1	GLC	Tape & Reel
		Active Low (Continuous 1.0A)	AP2822DKBTR-G1	GLD	Tape & Reel
		Active High (Continuous 1.5A)	AP2822EKBTR-G1	GLE	Tape & Reel
		Active Low (Continuous 1.5A)	AP2822FKBTR-G1	GLF	Tape & Reel
		Active High (Continuous 2.0A)	AP2822GKBTR-G1	GLG	Tape & Reel
		Active Low (Continuous 2.0A)	AP2822HKBTR-G1	GLH	Tape & Reel

**0.5A to 2.0A High-side Power Distribution Switches****AP2822****Ordering Information (Continued)**

Package	Temperature Range	Condition	Part Number	Marking ID	Packing Type
SOT-23-5	-40 to 85°C	Active High (Continuous 0.5A)	AP2822AKETR-G1	GLI	Tape & Reel
		Active Low (Continuous 0.5A)	AP2822BKETR-G1	GLJ	Tape & Reel
		Active High (Continuous 1.0A)	AP2822CKETR-G1	GLK	Tape & Reel
		Active Low (Continuous 1.0A)	AP2822DKETR-G1	GLL	Tape & Reel
		Active High (Continuous 1.5A)	AP2822EKETR-G1	GLM	Tape & Reel
		Active Low (Continuous 1.5A)	AP2822FKETR-G1	GLN	Tape & Reel
		Active High (Continuous 2.0A)	AP2822GKETR-G1	GLO	Tape & Reel
		Active Low (Continuous 2.0A)	AP2822HKETR-G1	GLP	Tape & Reel

BCD Semiconductor's Pb-free products, as designated with "G1" suffix in the part number, are RoHS compliant and green.

**0.5A to 2.0A High-side Power Distribution Switches****AP2822****Absolute Maximum Ratings (Note 1)**

Parameter	Symbol	Value	Unit
Power Supply Voltage	$V_{IN}$	6.0	V
Operating Junction Temperature Range	$T_J$	150	°C
Storage Temperature Range	$T_{STG}$	-65 to 150	°C
Lead Temperature (Soldering, 10sec)	$T_{LEAD}$	260	°C
Thermal Resistance (Junction to Ambient)	$\theta_{JA}$	TBD	°C/W
ESD (Machine Model)		200	V
ESD (Human Body Model)		2000	V

Note 1: Stresses greater than those listed under “Absolute Maximum Ratings” may cause permanent damage to the device. These are stress ratings only, and functional operation of the device at these or any other conditions beyond those indicated under “Recommended Operating Conditions” is not implied. Exposure to “Absolute Maximum Ratings” for extended periods may affect device reliability.

**Recommended Operating Conditions**

Parameter	Symbol	Min	Max	Unit
Supply Voltage	$V_{IN}$	2.7	5.5	V
Operating Ambient Temperature Range	$T_A$	-40	85	°C





**0.5A to 2.0A High-side Power Distribution Switches**

**AP2822**

**Electrical Characteristics**

( $V_{IN}=5.0V$ ,  $C_{IN}=2.2\mu F$ ,  $C_{OUT}=1.0\mu F$ , Typical  $T_A=25^\circ C$ , unless otherwise specified)

Parameter	Symbol	Condition	Min	Typ	Max	Unit
Supply Voltage	$V_{IN}$		2.7		5.5	V
Switch On Resistance	$R_{DS(ON)}$	$V_{IN}=5.0V$ , $I_{OUT}=2.0A$		85	110	m $\Omega$
Current Limit	$I_{LIMIT}$	AP2822A/B(0.5A), $V_{OUT}=4.0V$	0.7	1.0	1.4	A
		AP2822C/D(1.0A), $V_{OUT}=4.0V$	1.1	1.5	2.1	
		AP2822E/F(1.5A), $V_{OUT}=4.0V$	1.65	2.2	2.8	
		AP2822G/H(2.0A), $V_{OUT}=4.0V$	2.2	2.7	3.2	
Supply Current	$I_{SUPPLY}$	$V_{IN}=5.0V$ , No Load		68	95	$\mu A$
Fold-back Short Current	$I_{SHORT}$	AP2822 A/B/C/D, $V_{OUT}=0V$		0.7		A
		AP2822 E/F/G/H, $V_{OUT}=0V$		1.1		
Shutdown Supply Current	$I_{SHUTDOWN}$	Chip Disable, Shutdown Mode		0.1	1.0	$\mu A$
Enable High Input Threshold	$V_{ENH}$		1.6		5.5	V
Enable Low Input Threshold	$V_{ENL}$		0		1.0	V
Enable Pin Input Current	$I_{EN}$	Force 0V to 5.0V at EN Pin	-1.0		1.0	$\mu A$
Under Voltage Lockout Threshold Voltage	$V_{UVLO}$	$V_{IN}$ Increasing from 0V	2.2	2.5	3.0	V
Under Voltage Hysteresis	$V_{UVLOHY}$			0.2		V
Reverse Current	$I_{REVERSE}$	Chip Disable, $V_{OUT}>V_{IN}$		0.1	1.0	$\mu A$
Output Pull Low Resistance after Shutdown	$R_{DISCHARGE}$			100	200	$\Omega$
Output Turn-on Time	$t_{ON}$	From Enable Active to 90% of Output		500		$\mu s$
FLAG Pin Delay Time	$t_{DFLG}$	From Over Current Fault Condition to Flag Active	5	10	15	ms
FLAG Pin Low Voltage	$V_{FLG}$	$I_{SINK}=5.0mA$		35	70	mV
FLAG Pin Leakage Current	$I_{LEAKAGE}$	FLAG Disable, Force 5.0V			1.0	$\mu A$
Thermal Shutdown Temperature	$T_{OTSD}$			150		$^\circ C$
Thermal Shutdown Hysteresis	$T_{HYOTSD}$			30		



0.5A to 2.0A High-side Power Distribution Switches

AP2822

Typical Performance Characteristics

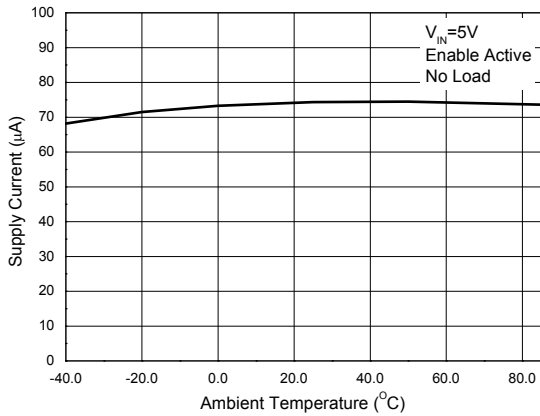

Figure 4. Supply Current vs. Ambient Temperature

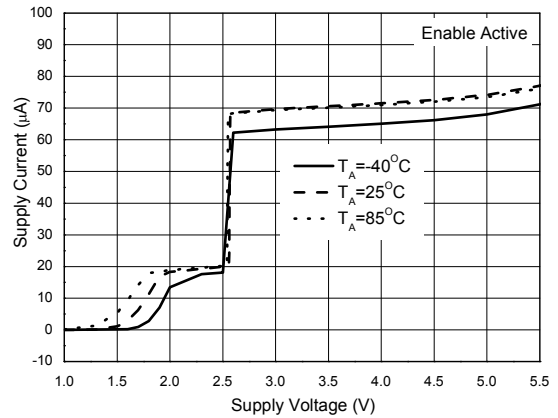

Figure 5. Supply Current vs. Supply Voltage

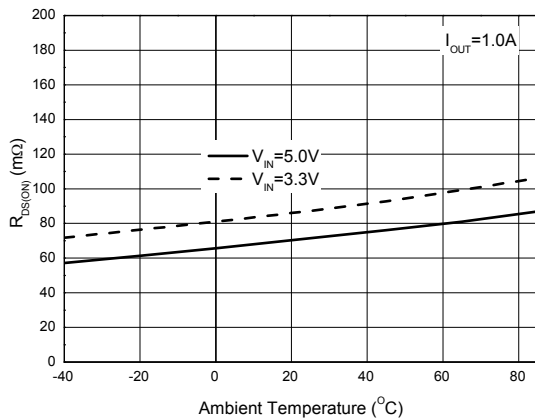

Figure 6. R<sub>DS(ON)</sub> vs. Ambient Temperature

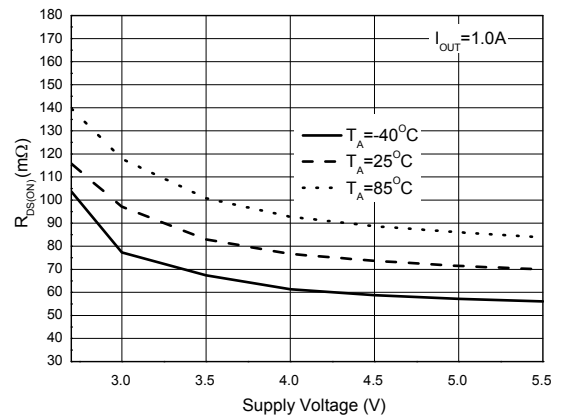

Figure 7. R<sub>DS(ON)</sub> vs. Supply Voltage

Typical Performance Characteristics (Continued)

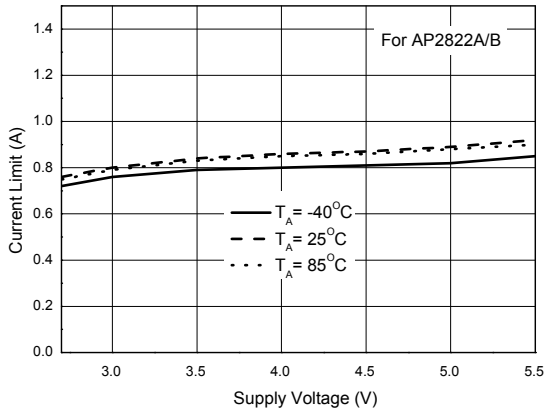

Figure 8. Current Limit vs. Supply Voltage

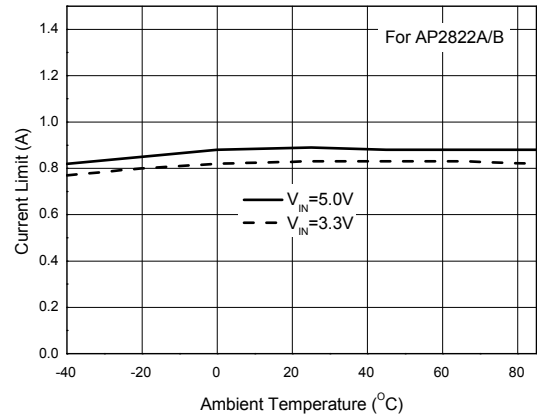

Figure 9. Current Limit vs. Ambient Temperature

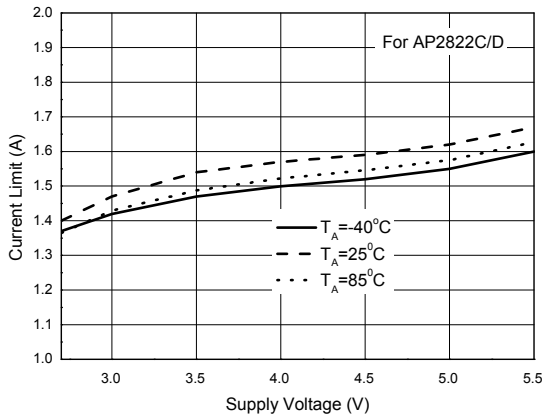

Figure 10. Current Limit vs. Supply Voltage

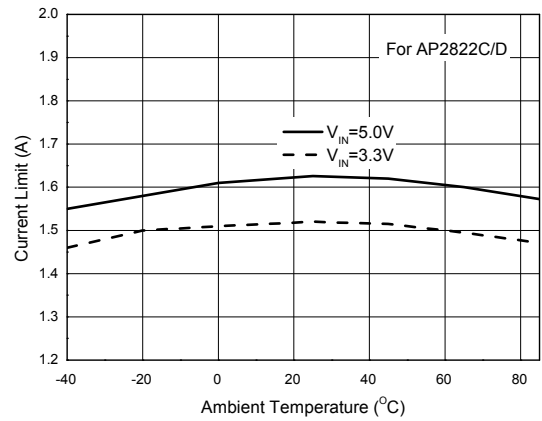

Figure 11. Current Limit vs. Ambient Temperature

**0.5A to 2.0A High-side Power Distribution Switches**

**AP2822**

**Typical Performance Characteristics (Continued)**



Figure 12. Current Limit vs. Supply Voltage



Figure 13. Current Limit vs. Ambient Temperature



Figure 14. Current Limit vs. Supply Voltage



Figure 15. Current Limit vs. Ambient Temperature

Typical Performance Characteristics (Continued)

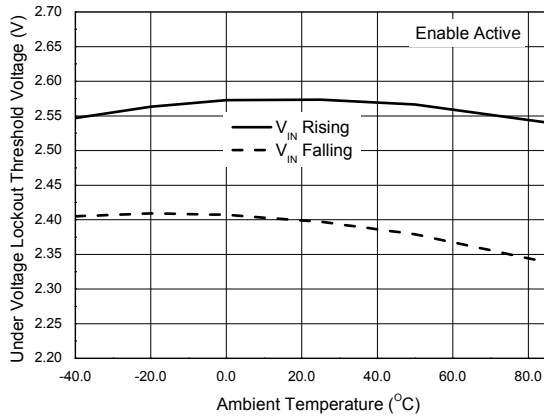

Figure 16. UVLO Voltage vs. Ambient Temperature

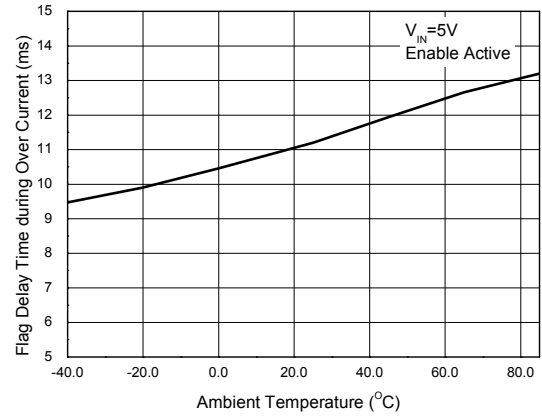

Figure 17. Flag Delay Time during Over Current vs. Ambient Temperature



Figure 18. Flag Delay Time during Over Current vs. Supply Voltage



Figure 19. Output Short to GND Current vs. Supply Voltage

**0.5A to 2.0A High-side Power Distribution Switches**

**AP2822**

**Typical Performance Characteristics (Continued)**



Figure 20. Output Short to GND Current vs. Ambient Temperature



Figure 21. Enable Threshold Voltage vs. Ambient Temperature



Figure 22. Enable Threshold Voltage vs. Supply Voltage



Figure 23. Output Turn On and Rise Time (C<sub>IN</sub>=1.0µF, C<sub>OUT</sub>=1.0µF, No Load)

**0.5A to 2.0A High-side Power Distribution Switches**
**AP2822**
**Typical Performance Characteristics (Continued)**

Time 500µs/div

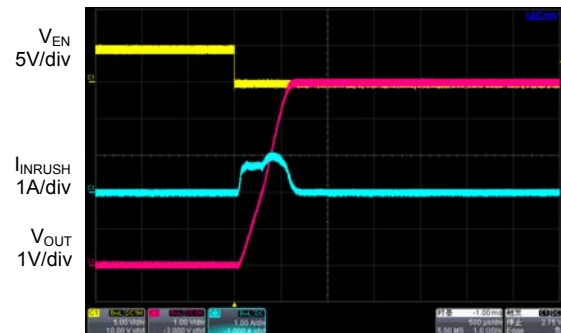
 Figure 24. Output Turn On and Rise Time  
 ( $C_{IN}=1.0\mu F$ ,  $C_{OUT}=1.0\mu F$ ,  $R_L=3.3\Omega$ )

Time 500µs/div

 Figure 25. Output Turn On and Rise Time  
 ( $C_{IN}=1.0\mu F$ ,  $C_{OUT}=100\mu F$ , No Load)

Time 5ms/div

 Figure 26. Output Turn Off and Fall Time  
 ( $V_{IN}=5V$ ,  $C_{IN}=1.0\mu F$ , No Load)

Time 500µs/div

 Figure 27. Output Turn Off and Fall Time  
 ( $V_{IN}=5V$ ,  $C_{IN}=1.0\mu F$ ,  $C_{OUT}=470\mu F$ ,  $R_L=3.3\Omega$ )

**0.5A to 2.0A High-side Power Distribution Switches**

**AP2822**

**Typical Performance Characteristics (Continued)**



Time 20ms/div

Figure 28. Output Short to GND Current ( $V_{IN}=5V$ ,  $C_{IN}=1.0\mu F$ )

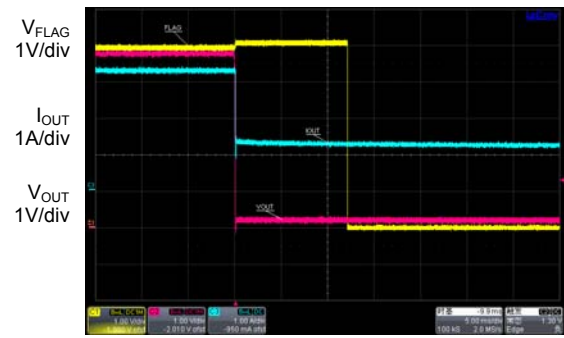

Time 5ms/div

Figure 29. FLAG Response during Over Current



Time 5ms/div

Figure 30. FLAG Response during Over Temperature ( $T_A=125\text{ }^\circ\text{C}$ )



## Typical Application

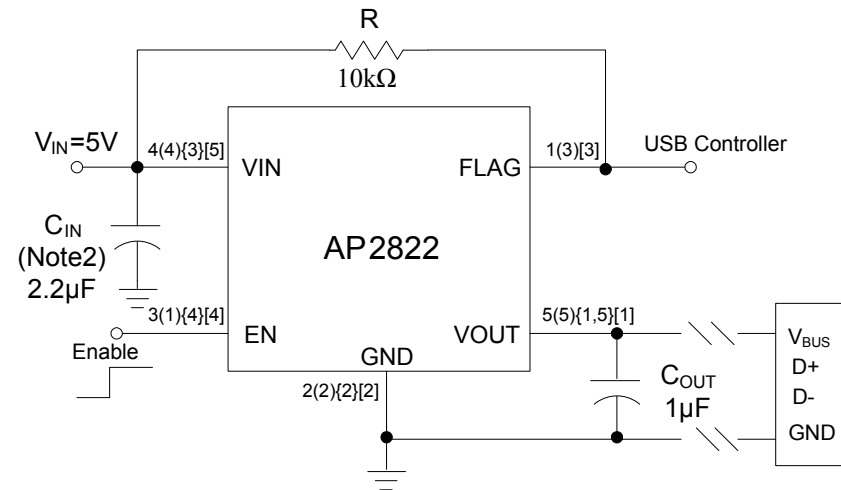

A(B){C}[D]  
 A: SOT-23-5(K Package)  
 B: SOT-23-5(KA Package)  
 C: SOT-23-5(KB Package)  
 D: SOT-23-5(KE Package)

Note 2: 2.2µF input capacitor is enough in most application cases.

If the VOUT is short to ground frequently during usage, large size input capacitor is necessary, recommend 22µF.

Figure 31. Typical Application of AP2822

**0.5A to 2.0A High-side Power Distribution Switches**

**AP2822**

**Mechanical Dimensions**

**SOT-23-5**

**Unit: mm(inch)**

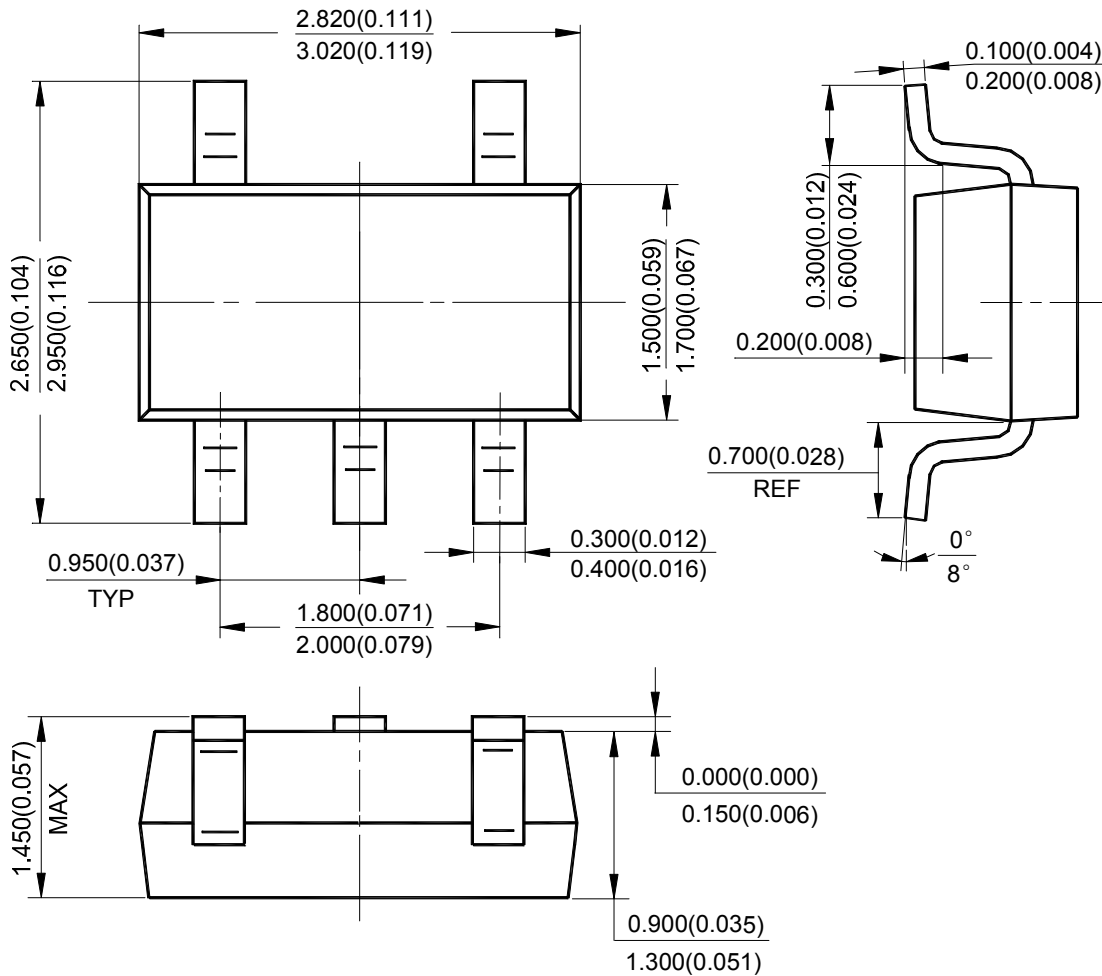



## **BCD Semiconductor Manufacturing Limited**

<http://www.bcdsemi.com>

### **IMPORTANT NOTICE**

BCD Semiconductor Manufacturing Limited reserves the right to make changes without further notice to any products or specifications herein. BCD Semiconductor Manufacturing Limited does not assume any responsibility for use of any its products for any particular purpose, nor does BCD Semiconductor Manufacturing Limited assume any liability arising out of the application or use of any its products or circuits. BCD Semiconductor Manufacturing Limited does not convey any license under its patent rights or other rights nor the rights of others.

---

#### **MAIN SITE**

##### **- Headquarters**

##### **BCD Semiconductor Manufacturing Limited**

No. 1600, Zi Xing Road, Shanghai ZiZhu Science-based Industrial Park, 200241, China  
Tel: +86-21-24162266, Fax: +86-21-24162277

##### **- Wafer Fab**

##### **Shanghai SIM-BCD Semiconductor Manufacturing Co., Ltd.**

800 Yi Shan Road, Shanghai 200233, China  
Tel: +86-21-6485 1491, Fax: +86-21-5450 0008

#### **REGIONAL SALES OFFICE**

##### **Shenzhen Office**

##### **Shanghai SIM-BCD Semiconductor Manufacturing Co., Ltd., Shenzhen Office**

Unit A Room 1203, Skyworth Bldg., Gaoxin Ave. 1.S., Nanshan District, Shenzhen, China  
Tel: +86-755-8826 7951  
Fax: +86-755-8826 7865

##### **Taiwan Office**

##### **BCD Semiconductor (Taiwan) Company Limited**

4F, 298-1, Rui Guang Road, Nei-Hu District, Taipei, Taiwan  
Tel: +886-2-2656 2808  
Fax: +886-2-2656 2806

##### **USA Office**

##### **BCD Semiconductor Corp.**

30920 Huntwood Ave. Hayward, CA 94544, USA  
Tel : +1-510-324-2988  
Fax: +1-510-324-2788

Компания «Life Electronics» занимается поставками электронных компонентов импортного и отечественного производства от производителей и со складов крупных дистрибьюторов Европы, Америки и Азии.

С конца 2013 года компания активно расширяет линейку поставок компонентов по направлению коаксиальный кабель, кварцевые генераторы и конденсаторы (керамические, пленочные, электролитические), за счёт заключения дистрибьюторских договоров

Мы предлагаем:

- Конкурентоспособные цены и скидки постоянным клиентам.
- Специальные условия для постоянных клиентов.
- Подбор аналогов.
- Поставку компонентов в любых объемах, удовлетворяющих вашим потребностям.
- Приемлемые сроки поставки, возможна ускоренная поставка.
- Доставку товара в любую точку России и стран СНГ.
- Комплексную поставку.
- Работу по проектам и поставку образцов.
- Формирование склада под заказчика.
- Сертификаты соответствия на поставляемую продукцию (по желанию клиента).
- Тестирование поставляемой продукции.
- Поставку компонентов, требующих военную и космическую приемку.
- Входной контроль качества.
- Наличие сертификата ISO.

В составе нашей компании организован Конструкторский отдел, призванный помогать разработчикам, и инженерам.

Конструкторский отдел помогает осуществить:

- Регистрацию проекта у производителя компонентов.
- Техническую поддержку проекта.
- Защиту от снятия компонента с производства.
- Оценку стоимости проекта по компонентам.
- Изготовление тестовой платы монтаж и пусконаладочные работы.



Тел: +7 (812) 336 43 04 (многоканальный)

Email: [org@lifeelectronics.ru](mailto:org@lifeelectronics.ru)