



# Chip Beads

For power line

# MPZ series

---

<b>MPZ0603</b>	<b>0603[0201 inch]*</b>
<b>MPZ1005</b>	<b>1005[0402 inch]</b>
<b>MPZ1608</b>	<b>1608[0603 inch]</b>
<b>MPZ2012</b>	<b>2012[0805 inch]</b>

\* Dimensions Code JIS[EIA]

---

## REMINDERS FOR USING THESE PRODUCTS

Before using these products, be sure to request the delivery specifications.

### SAFETY REMINDERS

Please pay sufficient attention to the warnings for safe designing when using these products.

#### REMINDERS

- The storage period is less than 12 months. Be sure to follow the storage conditions (Temperature: 5 to 40°C, Humidity: 10 to 75% RH or less).  
If the storage period elapses, the soldering of the terminal electrodes may deteriorate.
- Do not use or store in locations where there are conditions such as gas corrosion (salt, acid, alkali, etc.).
- Before soldering, be sure to preheat components.  
The preheating temperature should be set so that the temperature difference between the solder temperature and chip temperature does not exceed 150°C.
- Soldering corrections after mounting should be within the range of the conditions determined in the specifications.  
If overheated, a short circuit, performance deterioration, or lifespan shortening may occur.
- When embedding a printed circuit board where a chip is mounted to a set, be sure that residual stress is not given to the chip due to the overall distortion of the printed circuit board and partial distortion such as at screw tightening portions.
- Self heating (temperature increase) occurs when the power is turned ON, so the tolerance should be sufficient for the set thermal design.
- Carefully lay out the coil for the circuit board design of the non-magnetic shield type.  
A malfunction may occur due to magnetic interference.
- Use a wrist band to discharge static electricity in your body through the grounding wire.
- Do not expose the products to magnets or magnetic fields.
- Do not use for a purpose outside of the contents regulated in the delivery specifications.
- The products listed on this catalog are intended for use in general electronic equipment (AV equipment, telecommunications equipment, home appliances, amusement equipment, computer equipment, personal equipment, office equipment, measurement equipment, industrial robots) under a normal operation and use condition.  
The products are not designed or warranted to meet the requirements of the applications listed below, whose performance and/or quality require a more stringent level of safety or reliability, or whose failure, malfunction or trouble could cause serious damage to society, person or property.  
If you intend to use the products in the applications listed below or if you have special requirements exceeding the range or conditions set forth in the each catalog, please contact us.

(1) Aerospace/Aviation equipment  
 (2) Transportation equipment (cars, electric trains, ships, etc.)  
 (3) Medical equipment  
 (4) Power-generation control equipment  
 (5) Atomic energy-related equipment  
 (6) Seabed equipment  
 (7) Transportation control equipment

(8) Public information-processing equipment  
 (9) Military equipment  
 (10) Electric heating apparatus, burning equipment  
 (11) Disaster prevention/crime prevention equipment  
 (12) Safety equipment  
 (13) Other applications that are not considered general-purpose applications

When designing your equipment even for general-purpose applications, you are kindly requested to take into consideration securing protection circuit/device or providing backup circuits in your equipment.

# Chip Beads

## For power line

Product compatible with RoHS directive  
Halogen-free  
Compatible with lead-free solders

# Overview of the MPZ Series

## FEATURES

- Noise reduction solution for power line.
- Compared to the MMZ Series, has low direct current resistance for compatibility with large currents, optimal for low power consumption.
- Lineup includes 4 sizes from 0603 to 2012.
- Various frequency characteristics with 5 materials of different features for countermeasures against everything from general signals to high-speed signals.
- Performs well even in signal lines where low direct current resistance is required.

## APPLICATION

- Noise removal for mobile devices such as smartphones and tablet terminals, and various modules.
- Noise removal for PCs and recorders, household appliances such as STBs, smart grids, and industrial equipment.

## PART NUMBER CONSTRUCTION

MPZ	0603	S	220	C	T	000			
Series name	LxWxT Dimensions (mm)		Material name	Impedance (Ω) at 100MHz		Characteristic type	Packaging style		Internal code
	0603	0.6x0.3x0.3		S	220		22	C	
1005	1.0x0.5x0.5	Y			A			A00	
1608	1.6x0.8x0.6	B			B			AH0	
	1.6x0.8x0.8	R							
2012	2.0x1.25x0.85	D							

## OPERATING TEMPERATURE RANGE, PACKAGE QUANTITY, PRODUCT WEIGHT

Type	Temperature range		Package quantity (pieces/reel)	Individual weight (mg)	
	Operating temperature (°C)	Storage temperature* (°C)			
	MPZ0603	-55 to +125			-55 to +125
MPZ1005	-55 to +125	-55 to +125	10,000	1	
MPZ1608	t=0.6mm	-55 to +125	-55 to +125	4,000	3
	t=0.8mm	-55 to +125	-55 to +125	4,000	4
MPZ2012	-55 to +125	-55 to +125	4,000	8	

\* The Storage temperature range is for after the circuit board is mounted.

- RoHS Directive Compliant Product: See the following for more details related to RoHS Directive compliant products. <http://www.tdk.co.jp/rohs/>
- Halogen-free: Indicates that Cl content is less than 900ppm, Br content is less than 900ppm, and that the total Cl and Br content is less than 1500ppm.

• All specifications are subject to change without notice.

# Overview of the MPZ Series

## RECOMMENDED REFLOW PROFILE



Preheating			Soldering		Peak	
Temp.	Temp.	Time	Temp.	Time	Temp.	Time
T1	T2	t1	T3	t2	T4	t3
150°C	180°C	60 to 120s	230°C	30 to 60s	250 to 260°C	10s

# Overview of the MPZ Series

## MATERIAL CHARACTERISTICS

**B material:** This type is perfectly suited for fast digital signals. By equalizing R components and X components that beads possess at a frequency of 5MHz, it is able to suppress overshooting, undershooting and ringing of fast digital signals.

**R material:** For wide frequency applications calling for broad impedance characteristics.

For digital signal line applications calling requiring good waveform integrity. Impedance values selected for effectiveness at 10 to 200MHz.

**S material:** Standard type that features impedance characteristics similar to those of a typical ferrite core.

For signal line applications in which the blocking region is near 100MHz. Impedance values selected for effectiveness at 40 to 300MHz.

**Y material:** High frequency range type intended for the 100MHz region and above.

For signal line applications in which the signal frequency is far from the cutoff frequency. Impedance values selected for effectiveness at 80 to 400MHz.

**D material:** For applications calling for low insertion loss at low frequencies and sharply increasing impedance at high frequencies.

Designed for high impedance at high frequencies (300MHz to 1GHz) for signal line applications.

## TYPICAL MATERIAL IMPEDANCE CHARACTERISTICS



MPZ series

# MPZ0603 Type



## SHAPE & DIMENSIONS

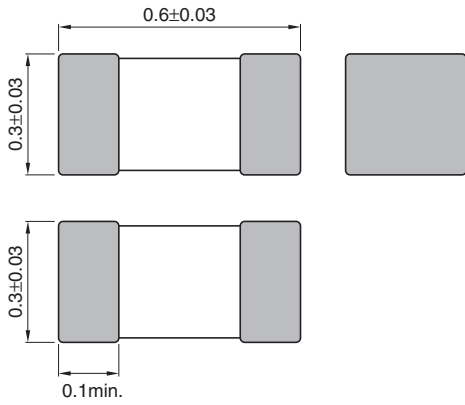

Dimensions in mm

## RECOMMENDED LAND PATTERN

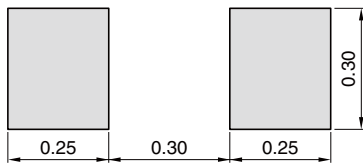

Dimensions in mm

• All specifications are subject to change without notice.

# MPZ series **MPZ0603 Type**

## ■ ELECTRICAL CHARACTERISTICS

### □ CHARACTERISTICS SPECIFICATION TABLE

Impedance [100MHz] ( $\Omega$ )	Tolerance	DC resistance ( $\Omega$ )max.	Rated current (mA)max.	Part No.
22	$\pm 25\%$	0.065	1000	MPZ0603S220CT000
33	$\pm 25\%$	0.090	750	MPZ0603S330CT000
47	$\pm 25\%$	0.120	500	MPZ0603S470CT000

### ○ Measurement equipment

Measurement item	Product No.	Manufacturer
Impedance	E4991A+16197	Agilent Technologies
DC resistance	Type-7556	Yokogawa

\* Equivalent measurement equipment may be used.

# MPZ series MPZ0603 Type

## ■ ELECTRICAL CHARACTERISTICS

### □ Z VS. FREQUENCY CHARACTERISTICS (BY SERIES)

#### MPZ0603S SERIES

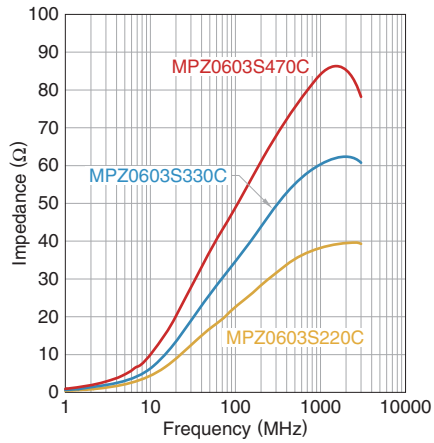



# MPZ series **MPZ0603 Type**

## ■ ELECTRICAL CHARACTERISTICS

### □ Z, X, R VS. FREQUENCY CHARACTERISTICS

**MPZ0603S220CT000**

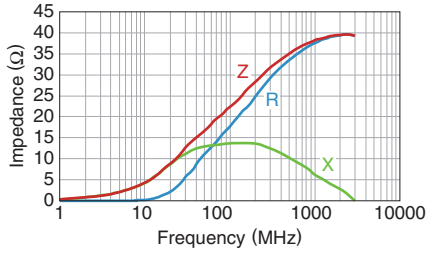

**MPZ0603S330CT000**

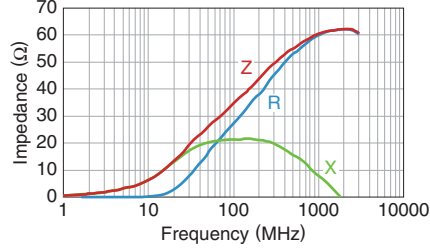

**MPZ0603S470CT000**

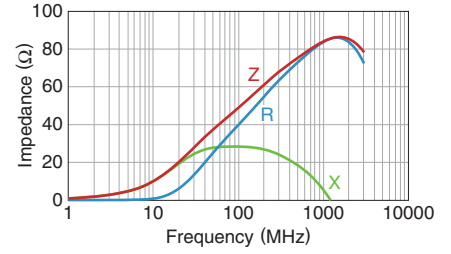

• All specifications are subject to change without notice.

MPZ series

# MPZ1005 Type



## SHAPE & DIMENSIONS

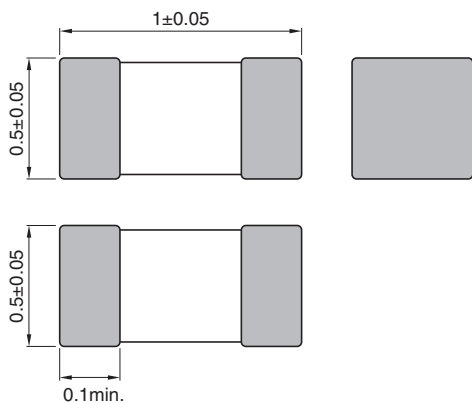

Dimensions in mm

## RECOMMENDED LAND PATTERN

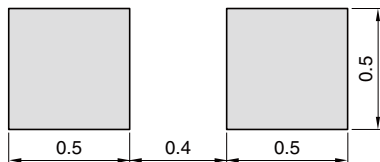

Dimensions in mm

• All specifications are subject to change without notice.

# MPZ series MPZ1005 Type

## ELECTRICAL CHARACTERISTICS

### CHARACTERISTICS SPECIFICATION TABLE

Impedance [100MHz] ( $\Omega$ )	Tolerance	DC resistance ( $\Omega$ )max.	Rated current (A)max.	Part No.
10	$\pm 5\Omega$	0.025	3.0	MPZ1005S100CT000
30	$\pm 10\Omega$	0.035	1.7	MPZ1005S300CT000
60	$\pm 25\%$	0.060	1.5	MPZ1005S600CT000
120	$\pm 25\%$	0.090	1.2	MPZ1005S121CT000
90	$\pm 25\%$	0.100	1.2	MPZ1005Y900CT000

\* Please refer to the graph of Rated current vs. temperature characteristics (derating) about the rating current at 85°C or more in temperature of the product.

#### Measurement equipment

Measurement item	Product No.	Manufacturer
Impedance	E4991A+16192A	Agilent Technologies
DC resistance	Type-7556	Yokogawa

\* Equivalent measurement equipment may be used.

#### Rated current vs. temperature characteristics (derating)



# MPZ series MPZ1005 Type

## ELECTRICAL CHARACTERISTICS

### Z VS. FREQUENCY CHARACTERISTICS (BY SERIES)

MPZ1005S SERIES



MPZ1005Y SERIES



• All specifications are subject to change without notice.

# MPZ series MPZ1005 Type

## ELECTRICAL CHARACTERISTICS

### Z, X, R VS. FREQUENCY CHARACTERISTICS

MPZ1005S100CT000

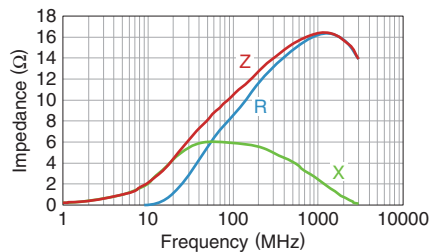

MPZ1005S300CT000

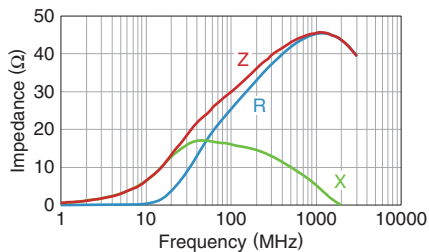

MPZ1005S600CT000



MPZ1005S121CT000

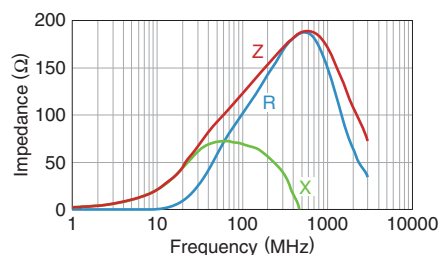

MPZ1005Y900CT000

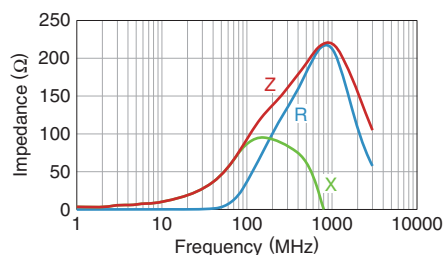

• All specifications are subject to change without notice.

MPZ series

# MPZ1608 Type



## SHAPE & DIMENSIONS



## RECOMMENDED LAND PATTERN



• All specifications are subject to change without notice.

# MPZ series MPZ1608 Type

## ELECTRICAL CHARACTERISTICS

### CHARACTERISTICS SPECIFICATION TABLE

Impedance [100MHz] ( $\Omega$ )	Tolerance	DC resistance ( $\Omega$ )max.	Rated current* (A)max.	Thickness T (mm)	Part No.
470	$\pm 25\%$	0.150	1.0	0.8	MPZ1608B471ATA00
26	$\pm 25\%$	0.007	6.0	0.6	MPZ1608S260ATAH0
30	$\pm 10\Omega$	0.010	5.0	0.6	MPZ1608S300ATAH0
60	$\pm 25\%$	0.020	3.5	0.6	MPZ1608S600ATAH0
100	$\pm 25\%$	0.030	3.0	0.6	MPZ1608S101ATAH0
120	$\pm 25\%$	0.045	2.0	0.6	MPZ1608S121ATAH0
180	$\pm 25\%$	0.050	2.0	0.6	MPZ1608S181ATAH0
220	$\pm 25\%$	0.050	2.2	0.8	MPZ1608S221ATA00
330	$\pm 25\%$	0.080	1.7	0.8	MPZ1608S331ATA00
470	$\pm 25\%$	0.150	1.0	0.8	MPZ1608S471ATA00
600	$\pm 25\%$	0.150	1.0	0.8	MPZ1608S601ATA00
1000	$\pm 25\%$	0.300	0.8	0.8	MPZ1608S102ATA00
390	$\pm 25\%$	0.120	1.2	0.8	MPZ1608R391ATA00
60	$\pm 25\%$	0.030	2.3	0.8	MPZ1608Y600BTA00
100	$\pm 25\%$	0.040	2.0	0.8	MPZ1608Y101BTA00
150	$\pm 25\%$	0.050	1.8	0.8	MPZ1608Y151BTA00
220	$\pm 25\%$	0.100	1.5	0.8	MPZ1608Y221BTA00
30	$\pm 10\Omega$	0.060	1.8	0.8	MPZ1608D300BTA00
60	$\pm 25\%$	0.100	1.2	0.8	MPZ1608D600BTA00
100	$\pm 25\%$	0.150	1.0	0.8	MPZ1608D101BTA00

\* Please refer to the graph of Rated current vs. temperature characteristics (derating) about the rating current at 85°C or more in temperature of the product.

#### Measurement equipment

Measurement item	Product No.	Manufacturer
Impedance	E4991A+16192A	Agilent Technologies
DC resistance	Type-7556	Yokogawa

\* Equivalent measurement equipment may be used.

#### Rated current vs. temperature characteristics (derating)

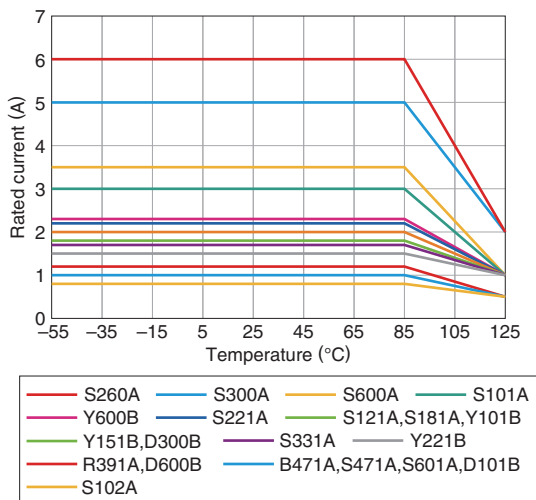

• All specifications are subject to change without notice.

# MPZ series MPZ1608 Type

## ELECTRICAL CHARACTERISTICS

### Z VS. FREQUENCY CHARACTERISTICS (BY SERIES)

MPZ1608B SERIES



MPZ1608S SERIES



MPZ1608R SERIES

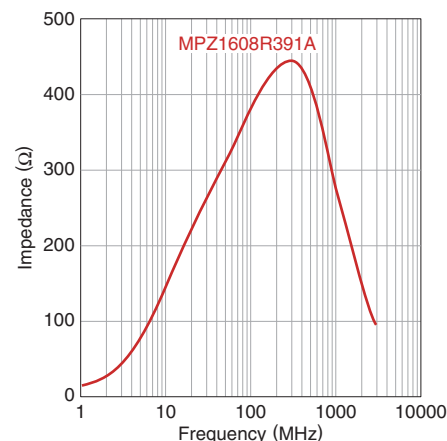

MPZ1608Y SERIES



MPZ1608D SERIES



• All specifications are subject to change without notice.



# MPZ series MPZ1608 Type

## ELECTRICAL CHARACTERISTICS

### Z, X, R VS. FREQUENCY CHARACTERISTICS

MPZ1608B471ATA00

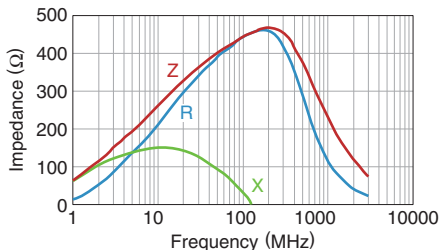

MPZ1608S260ATAH0

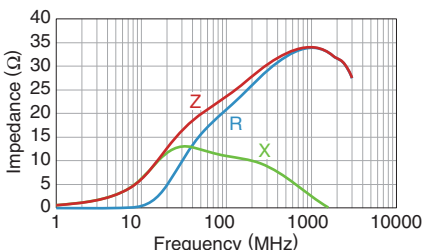

MPZ1608S300ATAH0

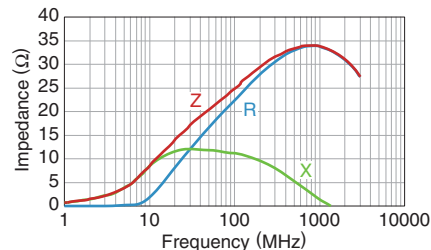

MPZ1608S600ATAH0

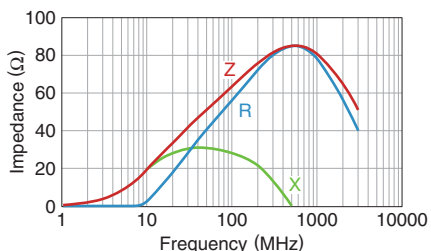

MPZ1608S101ATAH0

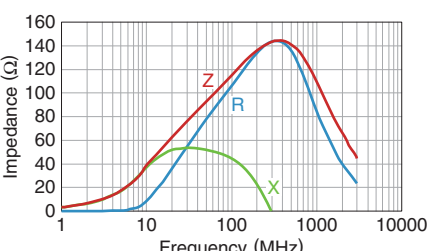

MPZ1608S121ATAH0

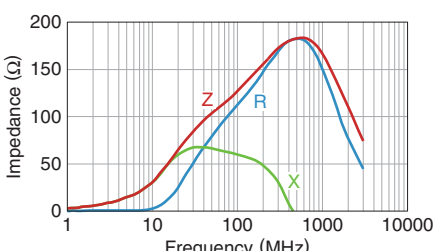

MPZ1608S181ATAH0

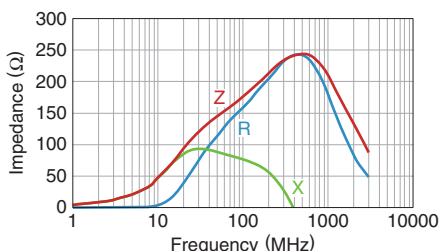

MPZ1608S221ATA00

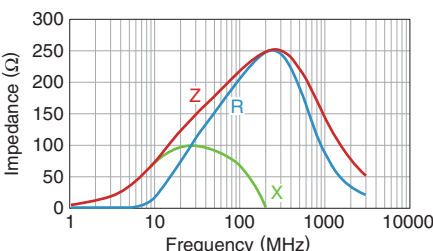

MPZ1608S331ATA00

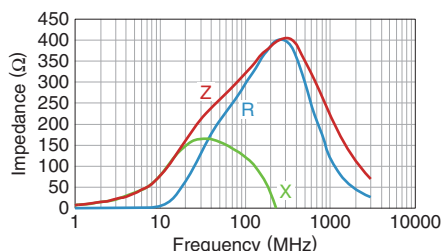

MPZ1608S471ATA00

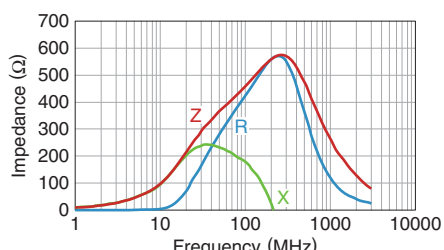

MPZ1608S601ATA00

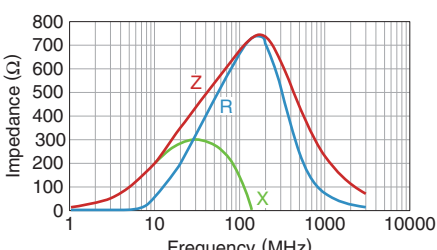

MPZ1608S102ATA00

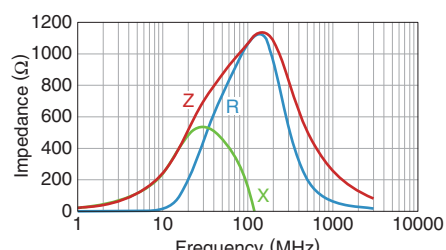

MPZ1608R391ATA00

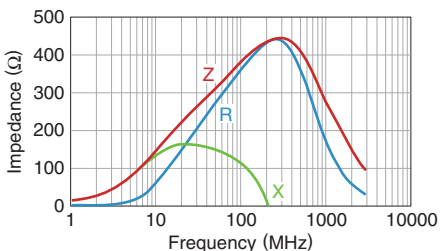

MPZ1608Y600BTA00

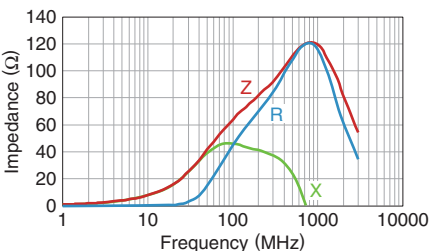

MPZ1608Y101BTA00

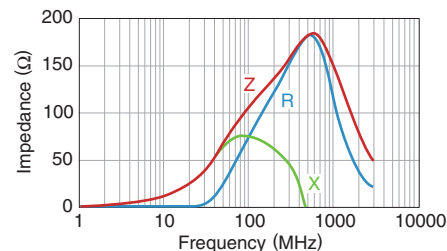

• All specifications are subject to change without notice.

# MPZ series MPZ1608 Type

## ELECTRICAL CHARACTERISTICS

### Z, X, R VS. FREQUENCY CHARACTERISTICS

MPZ1608Y151BTA00

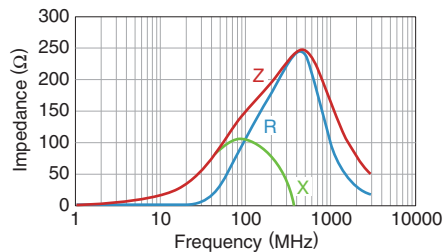

MPZ1608Y221BTA00



MPZ1608D300BTA00



MPZ1608D600BTA00

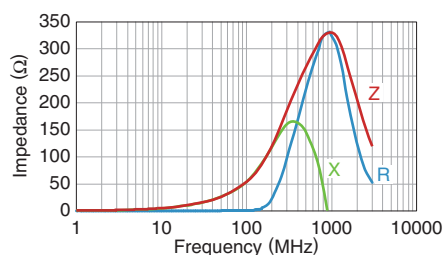

MPZ1608D101BTA00



• All specifications are subject to change without notice.

MPZ series

# MPZ2012 Type



## SHAPE & DIMENSIONS

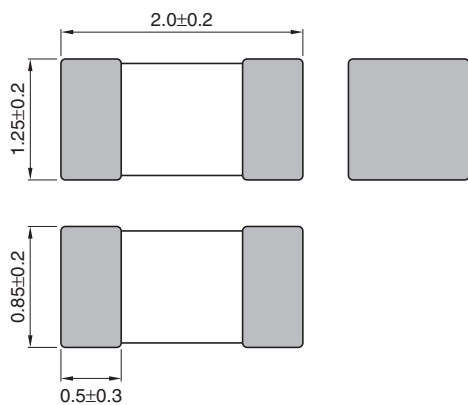

Dimensions in mm

## RECOMMENDED LAND PATTERN

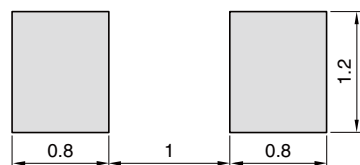

Dimensions in mm

• All specifications are subject to change without notice.

# MPZ series MPZ2012 Type

## ELECTRICAL CHARACTERISTICS

### CHARACTERISTICS SPECIFICATION TABLE

Impedance [100MHz] ( $\Omega$ )	Tolerance	DC resistance ( $\Omega$ )max.	Rated current* (A)max.	Part No.
30	$\pm 10\Omega$	0.010	6	MPZ2012S300AT000
100	$\pm 25\%$	0.020	4	MPZ2012S101AT000
220	$\pm 25\%$	0.040	3	MPZ2012S221AT000
330	$\pm 25\%$	0.050	2.5	MPZ2012S331AT000
600	$\pm 25\%$	0.100	2	MPZ2012S601AT000
1000	$\pm 25\%$	0.150	1.5	MPZ2012S102AT000

\* Please refer to the graph of Rated current vs. temperature characteristics (derating) about the rating current at 85°C or more in temperature of the product.

#### Measurement equipment

Measurement item	Product No.	Manufacturer
Impedance	E4991A+16192A	Agilent Technologies
DC resistance	Type-7556	Yokogawa

\* Equivalent measurement equipment may be used.

#### Rated current vs. temperature characteristics (derating)



# MPZ series MPZ2012 Type

## ELECTRICAL CHARACTERISTICS

### Z VS. FREQUENCY CHARACTERISTICS (BY SERIES)

#### MPZ2012S SERIES



• All specifications are subject to change without notice.

# MPZ series MPZ2012 Type

## ELECTRICAL CHARACTERISTICS

### Z, X, R VS. FREQUENCY CHARACTERISTICS

MPZ2012S300AT000



MPZ2012S101AT000



MPZ2012S221AT000



MPZ2012S331AT000



MPZ2012S601AT000

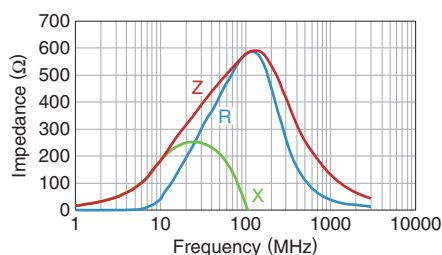

MPZ2012S102AT000



• All specifications are subject to change without notice.

MPZ series

# Packaging style

## REEL DIMENSIONS

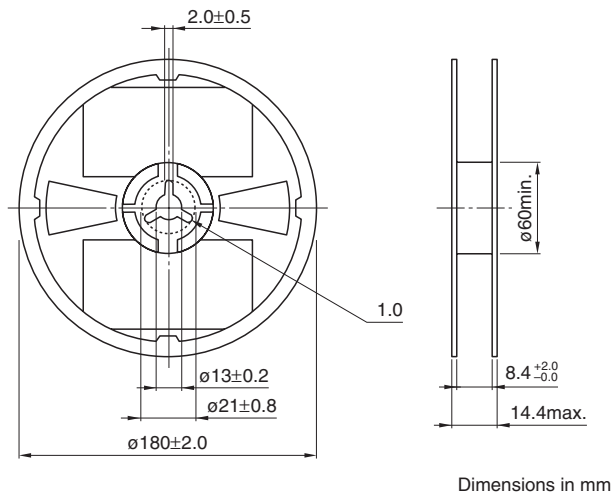

## TAPE DIMENSIONS

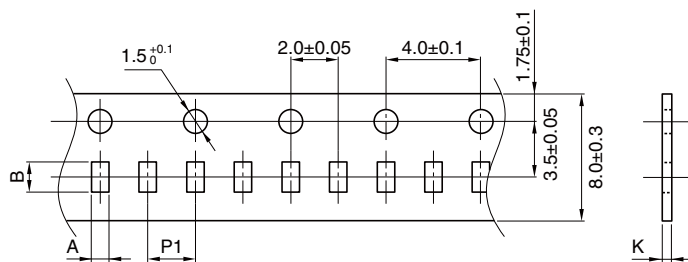

Dimensions in mm

Type	A	B	P1	K
MPZ0603	$0.38 \pm 0.05$	$0.68 \pm 0.05$	$2.0 \pm 0.05$	0.5max.
MPZ1005	$0.65 \pm 0.1$	$1.15 \pm 0.1$	$2.0 \pm 0.05$	0.8max.
MPZ1608	$1.1 \pm 0.2$	$1.9 \pm 0.2$	$4.0 \pm 0.1$	1.1max.
MPZ2012	$1.5 \pm 0.2$	$2.3 \pm 0.2$	$4.0 \pm 0.1$	1.1max.

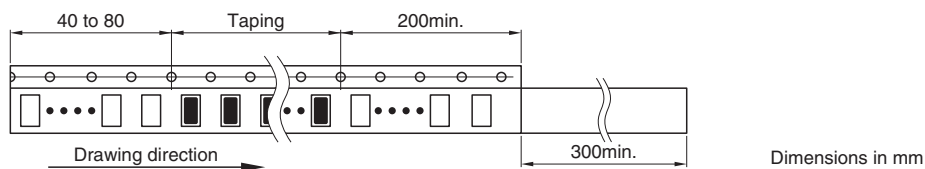

• All specifications are subject to change without notice.

Компания «Life Electronics» занимается поставками электронных компонентов импортного и отечественного производства от производителей и со складов крупных дистрибьюторов Европы, Америки и Азии.

С конца 2013 года компания активно расширяет линейку поставок компонентов по направлению коаксиальный кабель, кварцевые генераторы и конденсаторы (керамические, пленочные, электролитические), за счёт заключения дистрибьюторских договоров

Мы предлагаем:

- Конкурентоспособные цены и скидки постоянным клиентам.
- Специальные условия для постоянных клиентов.
- Подбор аналогов.
- Поставку компонентов в любых объемах, удовлетворяющих вашим потребностям.
- Приемлемые сроки поставки, возможна ускоренная поставка.
- Доставку товара в любую точку России и стран СНГ.
- Комплексную поставку.
- Работу по проектам и поставку образцов.
- Формирование склада под заказчика.
- Сертификаты соответствия на поставляемую продукцию (по желанию клиента).
- Тестирование поставляемой продукции.
- Поставку компонентов, требующих военную и космическую приемку.
- Входной контроль качества.
- Наличие сертификата ISO.

В составе нашей компании организован Конструкторский отдел, призванный помогать разработчикам, и инженерам.

Конструкторский отдел помогает осуществить:

- Регистрацию проекта у производителя компонентов.
- Техническую поддержку проекта.
- Защиту от снятия компонента с производства.
- Оценку стоимости проекта по компонентам.
- Изготовление тестовой платы монтаж и пусконаладочные работы.



Тел: +7 (812) 336 43 04 (многоканальный)

Email: [org@lifeelectronics.ru](mailto:org@lifeelectronics.ru)