

**Board Level Heat Sinks**

**BOARD LEVEL POWER SEMICONDUCTOR HEAT SINKS**

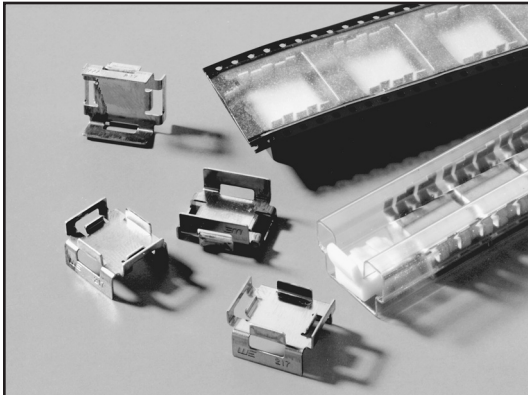

**217 SERIES Surface Mount Heat Sinks**

D<sup>2</sup>PAK, TO-220, SOT-223, SOL-20

Compatible with surface mount technology (SMT) automated production techniques for ease of assembly and a variety of soldering methods, these heat sinks allow greater packaging densities and reduction in PC-board area, increasing the power dissipation of surface mount devices (SMDs) while maintaining and improving manufacturers' component thermal specifications.

**FEATURES AND BENEFITS:**

- No interface material is needed
- Copper with matte tin plating for improved solderability and assembly
- Both the component and the heat sink are installed on the PC-board utilizing standard SMT assembly equipment for "Tape & Reel" and "Tube" formats
- EIA standards and ESD protection are specified
- Can be used with water soluble or no clean SMT solder creams or other pastes

Standard P/N	Height Above PC Board in. (mm)	Footprint Dimensions in. (mm)	Package Format	Package Quantity	Thermal Performance at Typical Load	
					Natural Convection	Forced Convection
217-36CTE6	.360 (9.1)	.600 (15.2) x .740 (18.8)	Bulk	1	55°C @ 1W	16.0°C/W @ 200 LFM
217-36CTTE6	.360 (9.1)	.600 (15.2) x .740 (18.8)	Tube	20	55°C @ 1W	16.0°C/W @ 200 LFM
217-36CTRE6	.360 (9.1)	.600 (15.2) x .740 (18.8)	Tape & Reel	250	55°C @ 1W	16.0°C/W @ 200 LFM

Material: Copper, Matte Tin Plated

**MECHANICAL DIMENSIONS**

**217 HEAT SINK WITH DPAK DEVICE**

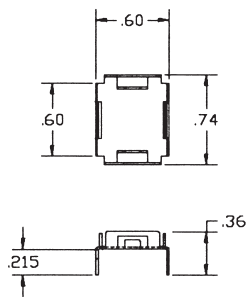

217-36CT6

**THERMAL PERFORMANCE 6 LAYER BOARD, D<sup>2</sup>PAK 125°C LEAD, 40°C AMBIENT**

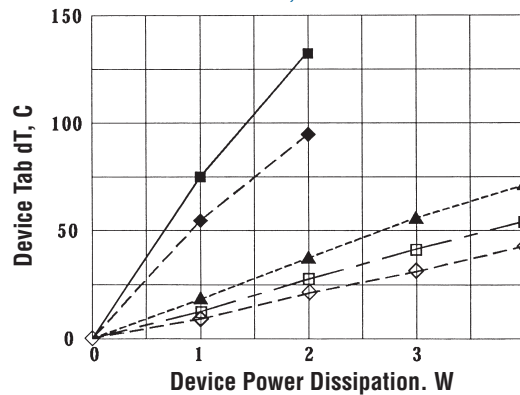

KEY: ■ Device only, NC ◆ Device + HS, NC ▲ Device + HS, 100 lfm □ Device + HS, 200 lfm ◇ Device + HS, 300 lfm



SECTION A-A

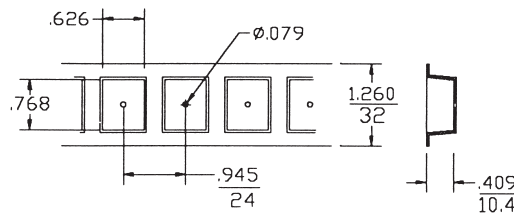

TAPE DETAILS

- NOTES**
1. Material to be "ESD"
  2. Approximately 6 Meters per Reel
  3. 250 Pieces per Reel.

217-36CTR6

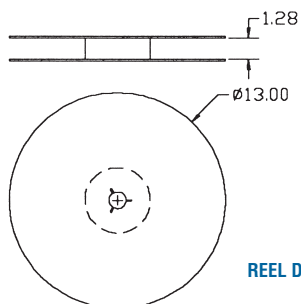

REEL DETAILS

Dimensions: in.

# BOARD LEVEL POWER SEMICONDUCTOR HEAT SINKS

**217 SERIES** Surface Mount Heat Sinks

D<sup>2</sup>PAK, TO-220, SOL-20

### MECHANICAL DIMENSIONS

#### 217 SERIES

##### TUBE DETAILS

TUBE: 16.25 Inches Long,  
Min. ESD Material with Nail Stops  
20 Pieces per Tube

**217-36CTT6**

### BOARD LAYOUT RECOMMENDATIONS

USE MAX COPPER TO ALLOW MAX CONDUCTION TO HEAT SINK

REF: JEDEC TO-220AB  
SOLDER MASK OPENING

REF: JEDEC TO-263 (DD PAK)  
REF: JEDEC MO-169 (DD PAK)

COPPER FOOTPRINT FOR HEATSINK

MIN COPPER FOR HEATSINK

**SOL 20**

**217-36CT6**

Dimensions: in.



**218 SERIES** Surface Mount Heat Sink

SMT Devices

Standard P/N	Height Above PC Board in. (mm)	Maximum Footprint in. (mm)	Thermal Performance at Typical Load	
			Natural Convection	Forced Convection
218-40CTE3	.40 (10.2)	.90 (22.9) x .315 (8.0)	62°C rise @ 2W	21°C/W @ 200LFM
218-40CTE5	.40 (10.2)	1.03 (26.2) x .50 (12.7)	62°C rise @ 2W	21°C/W @ 200LFM

Material: Copper, Matte Tin Plated

### MECHANICAL DIMENSIONS

**218-40CT3**

**218-40CT5**

### NATURAL AND FORCED CONVECTION CHARACTERISTICS

Solid line = 218-40CT5 Dashed Line = 218-40CT3



**Board Level Heat Sinks**

**BOARD LEVEL POWER SEMICONDUCTOR HEAT SINKS**



**206 SERIES**

*Vertical Mount Heat Sink*

TO-220

Standard P/N	Height Above PC Board in. (mm)	Maximum Footprint in. (mm)	Thermal Performance at Typical Load	
			Natural Convection	Forced Convection
206-1PABEH	1.18 (30.0)	1.00 (25.4) x .50 (12.7)	56°C rise @ 4W	7.3°C/W @ 200LFM

Material: Aluminum, Black Anodized

**MECHANICAL DIMENSIONS**

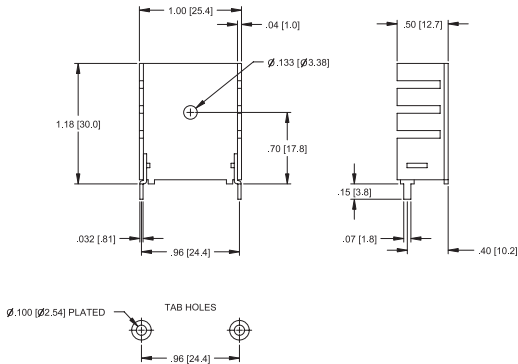

**NATURAL AND FORCED CONVECTION CHARACTERISTICS**



PATENT PENDING

**230 & 234 SERIES**

*Compact, Wavesolderable Low-Profile Self-Locking Heat Sinks*

TO-220

Standard P/N	Height Above PC Board in. (mm)	Footprint Dimensions in. (mm)	Mounting Configuration	Solderable Tab Option	Mounting Style	Thermal Performance at Typical Load	
						Natural Convection	Forced Convection
230-75AB	.750 (19.1)	.570 (14.5) x .500 (12.7)	Vert./Horiz.	No Tab	Clip/Mtg Hole	57°C @ 2W	7.5°C/W @ 400 LFM
230-75ABE-01	.750 (19.1)	.570 (14.5) x .500 (12.7)	Vertical	01	Clip/Mtg Hole	57°C @ 2W	7.5°C/W @ 400 LFM
230-75ABE-05	.500 (12.7)	.750 (19.1) x .570 (14.5)	Horizontal	05	Clip/Mtg Hole	57°C @ 2W	7.5°C/W @ 400 LFM
230-75ABE-10	.875 (22.2)	.570 (14.5) x .500 (12.7)	Vertical	10	Clip/Mtg Hole	57°C @ 2W	7.5°C/W @ 400 LFM
234-75AB	.790 (20.0)	.570 (14.5) x .500 (12.7)	Vert./Horiz.	No Tab	Clip/Mtg Hole	57°C @ 2W	7.5°C/W @ 400 LFM
234-75ABE-01	.790 (20.0)	.570 (14.5) x .500 (12.7)	Vertical	01	Clip/Mtg Hole	57°C @ 2W	7.5°C/W @ 400 LFM
234-75ABE-05	.500 (12.7)	.790 (20.0) x .570 (14.5)	Horizontal	05	Clip/Mtg Hole	57°C @ 2W	7.5°C/W @ 400 LFM

Material: Aluminum, Black Anodized

**MECHANICAL DIMENSIONS**



**230 SERIES**

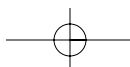
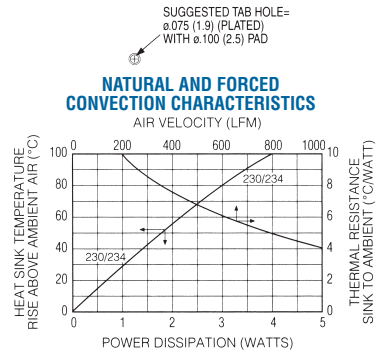

## BOARD LEVEL POWER SEMICONDUCTOR HEAT SINKS



### 241 SERIES Horizontal Mount Heat Sink

TO-220

Standard P/N	Height Above PC Board in. (mm)	Maximum Footprint in. (mm)	Thermal Performance at Typical Load	
			Natural Convection	Forced Convection
241-69ABE-03	.39 (9.9)	.86 (21.8) x .69 (17.5)	77°C rise @ 4W	12°C/W @ 200LFM

Material: Aluminum, Black Anodized



### 262 SERIES Horizontal and Vertical Mount Heat Sink

TO-220

Standard P/N	Height Above PC Board in. (mm)	Maximum Footprint in. (mm)	Thermal Performance at Typical Load	
			Natural Convection	Forced Convection
262-75ABE-05	.53 (13.4)	.75 (19.1) x .50 (12.78)	80°C rise @ 2W	10°C/W @ 200LFM
262-75ABE-01	.75 (19.1)	.53 (13.4) x .50 (12.7)	80°C rise @ 2W	10°C/W @ 200LFM

Material: Aluminum, Black Anodized



**Board Level Heat Sinks**

**BOARD LEVEL POWER SEMICONDUCTOR HEAT SINKS**

**233 & 236 SERIES**

**Self-Locking Wavesolderable Heat Sinks**

TO-220

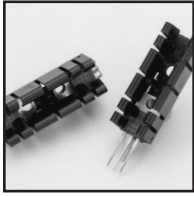

PATENT PENDING

Standard P/N	Height Above PC Board in. (mm)	Footprint Dimensions in. (mm)	Mounting Configuration	Solderable Tab Options	Mounting Style	Thermal Performance at Typical Load	
						Natural Convection	Forced Convection
233-60AB	.600 (15.2)	.570 (14.5) x .500 (12.7)	Vert./Horiz.	No Tab	Clip/Mtg Hole	58°C @ 2W	11.0°C/W @ 400 LFM
233-60ABE-01	.600 (15.2)	.570 (14.5) x .500 (12.7)	Vertical	01	Clip/Mtg Hole	58°C @ 2W	11.0°C/W @ 400 LFM
233-60ABE-05	.500 (12.7)	.600 (15.2) x .570 (14.5)	Horizontal	05	Clip/Mtg Hole	58°C @ 2W	11.0°C/W @ 400 LFM
233-60ABE-10	.725 (18.4)	.570 (14.5) x .500 (12.7)	Vertical	10	Clip/Mtg Hole	58°C @ 2W	11.0°C/W @ 400 LFM
236-150AB	1.500 (38.1)	.570 (14.5) x .500 (12.7)	Vert./Horiz.	No Tab	Clip/Mtg Hole	40°C @ 2W	4.80°C/W @ 400 LFM
236-150ABE-01	1.500 (38.1)	.570 (14.5) x .500 (12.7)	Vertical	01	Clip/Mtg Hole	40°C @ 2W	4.80°C/W @ 400 LFM
236-150ABE-05	.500 (12.7)	1.500 (38.1) x .570 (14.5)	Horizontal	05	Clip/Mtg Hole	40°C @ 2W	4.80°C/W @ 400 LFM
236-150ABE-10	1.625 (41.3)	.570 (14.5) x .570 (12.7)	Vertical	10	Clip/Mtg Hole	40°C @ 2W	4.80°C/W @ 400 LFM

Material: Aluminum, Black Anodized

**MECHANICAL DIMENSIONS 233 AND 236 SERIES**



**NATURAL AND FORCED CONVECTION CHARACTERISTICS**



SUGGESTED TAB HOLE = 0.075 (1.9) (PLATED) WITH 0.100 (2.5) PAD

**275 & 231 SERIES**

**Compact, Stress-Free Labor-Saving Locking-Tab Heat Sinks**

TO-220

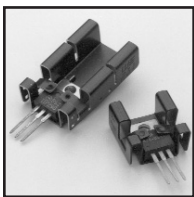

PATENT 5381041

Standard P/N	Height Above PC Board in. (mm)	Footprint Dimensions in. (mm)	Mounting Configuration	Solderable Tab Options	Mounting Style	Thermal Performance at Typical Load	
						Natural Convection	Forced Convection
275-75AB	.750 (19.1)	.835 (21.2) x .400 (12.7)	Vert./Horiz.	No Tab	Clip/Mtg Hole	44 C @ 2W	7.9°C/W @ 400 LFM
275-75ABE-01	.750 (19.1)	.835 (21.2) x .400 (12.7)	Vertical	01	Clip/Mtg Hole	44°C @ 2W	7.9°C/W @ 400 LFM
275-75ABE-10	.875 (12.7)	.835 (21.2) x .400 (14.5)	Vertical	10	Clip/Mtg Hole	44°C @ 2W	7.9°C/W @ 400 LFM
231-69PAB	.690 (18.4)	.835 (21.2) x .400 (12.7)	Vert./Horiz.	No Tab	Clip/Mtg Hole	45°C @ 2W	8°C/W @ 400 LFM
231-69PABE	.400 (10.1)	.690 (17.5) x .835 (12.7)	Horizontal	13H	Clip/Mtg Hole	45°C @ 2W	8°C/W @ 400 LFM
231-69PABE-XXX	.690 (17.5)	.835 (21.2) x .400 (12.7)	Vertical	13V, 14V, 15V	Clip/Mtg Hole	45°C @ 2W	8°C/W @ 400 LFM
231-75PAB	.750 (19.1)	.835 (21.2) x .400 (14.5)	Vert./Horiz.	No Tab	Clip/Mtg Hole	43°C @ 2W	7.9°C/W @ 400 LFM
231-75PABE	.400 (10.1)	.750 (19.1) x .835 (12.7)	Horizontal	13H	Clip/Mtg Hole	43°C @ 2W	7.9°C/W @ 400 LFM
231-75PABE-XXX	.750 (19.1)	.835 (21.2) x .400 (12.7)	Vertical	13V, 14V, 15V	Clip/Mtg Hole	43°C @ 2W	7.9°C/W @ 400 LFM
231-137PAB	1.375 (35)	.835 (21.2) x .400 (12.7)	Vert./Horiz.	No Tab	Clip/Mtg Hole	32°C @ 2W	5.9°C/W @ 400 LFM
231-137PABE	.400 (10.2)	1.375 (34.9) x .835 (12.7)	Horizontal	13H	Clip/Mtg Hole	32°C @ 2W	5.9°C/W @ 400 LFM
231-137PABE-XXX	1.375 (35)	.835 (21.2) x .400 (12.7)	Vertical	13V, 14V, 15V	Clip/Mtg Hole	32°C @ 2W	5.9°C/W @ 400 LFM

Material: Aluminum, Pre-anodized Black (PAB), Anodized Black (AB)

**MECHANICAL DIMENSIONS**



**NATURAL AND FORCED CONVECTION CHARACTERISTICS**



**NATURAL AND FORCED CONVECTION CHARACTERISTICS**





## BOARD LEVEL POWER SEMICONDUCTOR HEAT SINKS

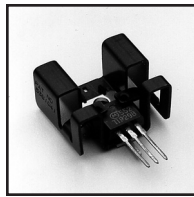

PATENT 5381041

### 235 SERIES Compact, Stress-Free Labor-Saving Locking-Tab Heat Sinks

TO-220

Standard P/N	Height Above PC Board in. (mm)	Footprint Dimensions in. (mm)	Mounting Configuration	Solderable Tab Options	Mounting Style	Thermal Performance at Typical Load	
						Natural Convection	Forced Convection
235-85AB	.850 (21.6)	1.000 (25.4) x .500 (12.7)	Vert./Horiz.	No Tab	Clip/Mtg Hole	40°C @ 2W	6.8°C/W @ 400 LFM
235-85ABE-01	.850 (21.6)	1.000 (25.4) x .500 (12.7)	Vertical	01	Clip/Mtg Hole	40°C @ 2W	6.8°C/W @ 400 LFM
235-85ABE-05	.500 (12.7)	.850 (21.6) x 1.000 (25.4)	Horizontal	05	Clip/Mtg Hole	40°C @ 2W	6.8°C/W @ 400 LFM
235-85ABE-10	.975 (24.8)	1.000 (25.4) x .500 (12.7)	Vertical	10	Clip/Mtg Hole	40°C @ 2W	6.8°C/W @ 400 LFM

Material: Aluminum, Black Anodized

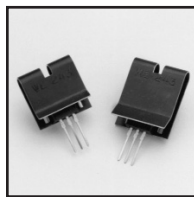
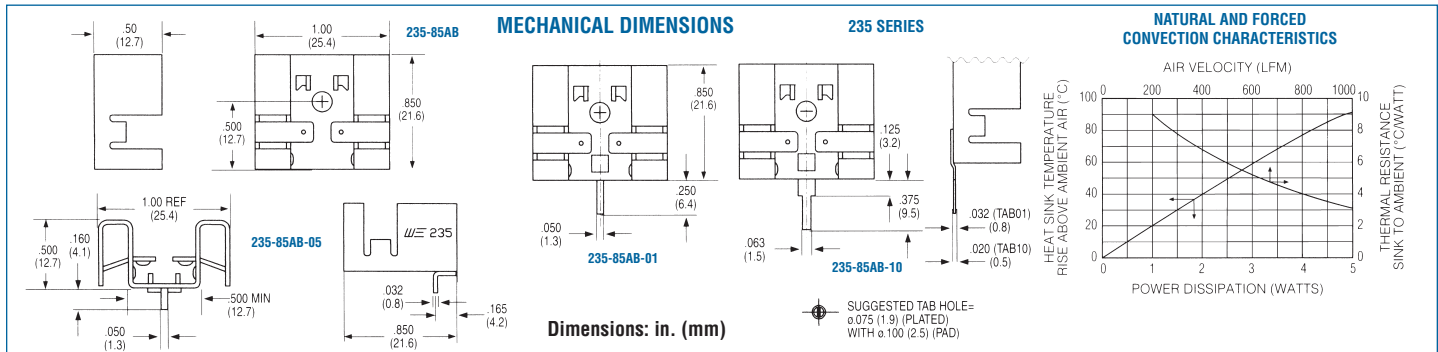

### 243 SERIES Labor-Saving Clip-On Heat Sinks

TO-220

Standard P/N	Height Above PC Board in. (mm)	Footprint Dimensions in. (mm)	Mounting Configuration	Solderable Tab Options	Mounting Style	Thermal Performance at Typical Load	
						Natural Convection	Forced Convection
243-1PAB	1.000 (25.4)	.800 (20.3) x .270 (6.9)	Vert./Horiz.	No Tab	Clip	50°C @ 2W	4.5°C/W @ 400 LFM
243-3PAB	.800 (20.3)	.800 (20.3) x .270 (6.9)	Vert./Horiz.	No Tab	Clip	78°C @ 2W	8.2°C/W @ 400 LFM

Material: Aluminum, Pre-anodized Black

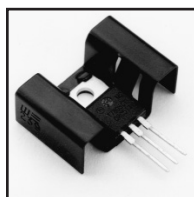
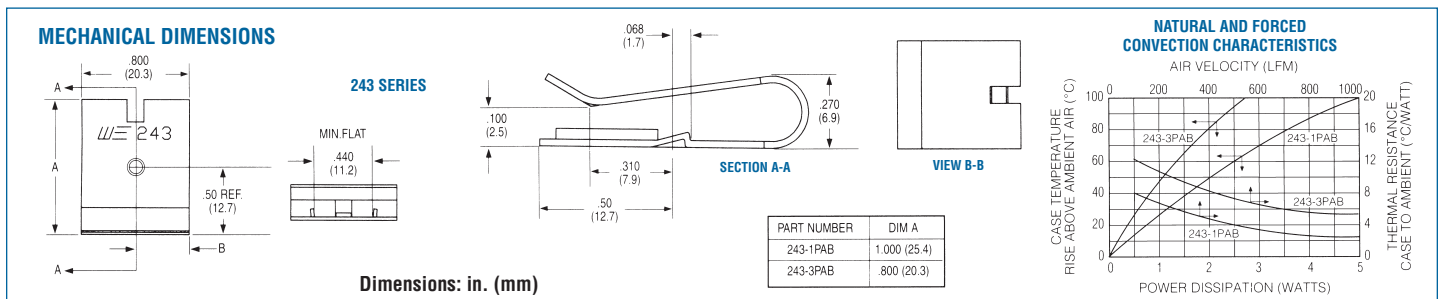

PATENT PENDING

### 239 SERIES Snap-Down Self-Locking Heat Sinks

TO-220

Standard P/N	Height Above PC Board in. (mm)	Footprint Dimensions in. (mm)	Mounting Configuration	Solderable Tab Options	Mounting Style	Thermal Performance at Typical Load	
						Natural Convection	Forced Convection
239-75AB	.750 (19.1)	1.120 (28.4) x .435 (11.0)	Vert./Horiz	No Tab	Clip/Mtg Hole	38°C @ 2W	6°C/W @ 400 LFM
239-75ABE-03	.750 (19.1)	1.120 (28.4) x .435 (11.0)	Vertical	03	Clip/Mtg Hole	38°C @ 2W	6°C/W @ 400 LFM
239-75ABE-04	.750 (19.1)	1.120 (28.4) x .435 (11.0)	Vertical	04	Clip/Mtg Hole	38°C @ 2W	6°C/W @ 400 LFM

Material: Aluminum, Black Anodized

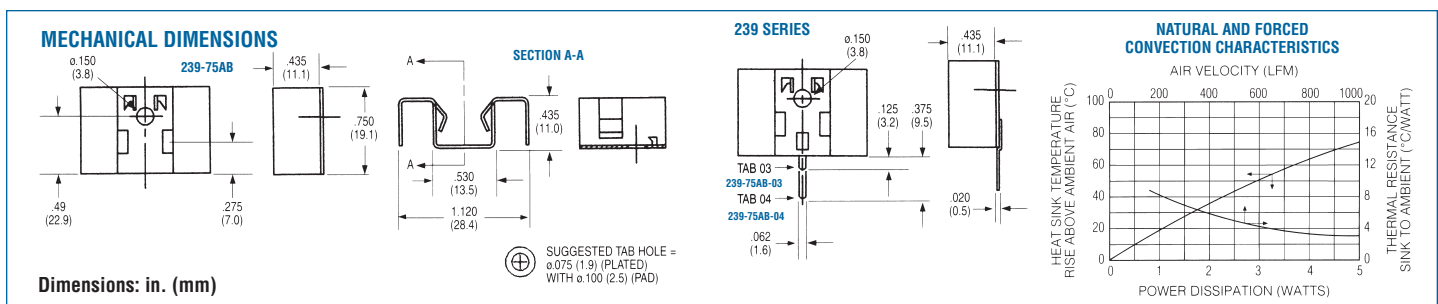

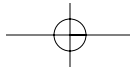

# Board Level Heat Sinks

## BOARD LEVEL POWER SEMICONDUCTOR HEAT SINKS

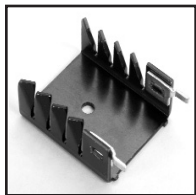

### 265 SERIES

### Vertical Mount Heat Sink

TO-220

Standard P/N	Height Above PC Board in. (mm)	Maximum Footprint in. (mm)	Thermal Performance at Typical Load	
			Natural Convection	Forced Convection
265-118ABHE-22	1.18 (30.0)	1.00 (25.4) x .50 (12.7)	56°C rise @ 4W	7.0°C/W @ 200LFM

Material: Aluminum, Black Anodized

#### MECHANICAL DIMENSIONS

Key dimensions include: 1.00 [25.4] total width, .125 [3.18] fin thickness, .70 [17.8] fin height, .030 [0.76] mounting hole offset, .95 [24.1] mounting hole diameter, .08 [2.03] fin pitch, .50 [12.7] fin length, .17 [4.3] fin base offset, .04 [1.0] fin tip offset, .40 [10.2] fin base width, and .100 [2.54] plated tab holes.

#### NATURAL AND FORCED CONVECTION CHARACTERISTICS

The graph plots Heat Sink Temperature Rise Above Ambient Air (°C) and Thermal Resistance Sink to Ambient (°C) against Heat Dissipated (Watts) and Air Velocity (LFM). Natural convection curves are shown for 0, 2, 4, 6, 8, and 10 LFM. Forced convection curves are shown for 200, 400, 600, 800, and 1000 LFM. Arrows indicate the direction of increasing performance with higher air velocity.

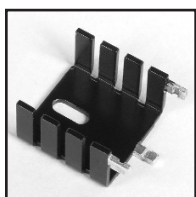

### 286DB SERIES

### Vertical Mount Heat Sink

TO-220

Standard P/N	Height Above PC Board in. (mm)	Maximum Footprint in. (mm)	Thermal Performance at Typical Load	
			Natural Convection	Forced Convection
286DBE	.95 (24.1)	1.00 (25.4) x .50 (12.7)	65°C rise @ 4W	9.0°C/W @ 200LFM

Material: Aluminum, Black Anodized

#### MECHANICAL DIMENSIONS

Key dimensions include: 1.00 [25.4] total width, .150 [3.8] fin thickness, .95 [24.1] fin height, .375 [9.5] mounting hole offset, .70 [17.8] fin height, .500 [12.7] mounting hole diameter, .081 [2.1] 3X fin pitch, .100 [2.5] fin base offset, .050 [1.3] fin tip offset, .200 [5.1] fin base width, .100 [2.5] fin base offset, and .500 [12.7] fin base width.

#### NATURAL AND FORCED CONVECTION CHARACTERISTICS

The graph plots Heat Sink Temperature Rise Above Ambient Air (°C) and Thermal Resistance Sink to Ambient (°C) against Heat Dissipated (Watts) and Air Velocity (LFM). Natural convection curves are shown for 0, 2, 4, 6, 8, and 10 LFM. Forced convection curves are shown for 200, 400, 600, 800, and 1000 LFM. Arrows indicate the direction of increasing performance with higher air velocity.

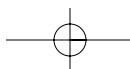

## BOARD LEVEL POWER SEMICONDUCTOR HEAT SINKS

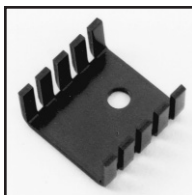

### 273 SERIES Low-Cost, Low-Height Wavesolderable Heat Sinks

TO-218, TO-220

Standard P/N	Height Above PC Board in. (mm)	Footprint Dimensions in. (mm)	Mounting Configuration	Solderable Tab Options	Mounting Style	Thermal Performance at Typical Load Natural Convection	Thermal Performance at Typical Load Forced Convection
273-AB	.375 (9.5)	.750 (19.1) x .750 (19.1)	Vert./Horiz.	No Tab	Mtg Hole	49°C @ 2W	7.2°C/W @ 400 LFM
273-ABE-01	.375 (9.5)	.750 (19.1) x .750 (19.1)	Vertical	01	Mtg Hole	49°C @ 2W	7.2°C/W @ 400 LFM
273-ABE-02	.375 (9.5)	.750 (19.1) x .750 (19.1)	Vertical	02	Mtg Hole	49°C @ 2W	7.2°C/W @ 400 LFM

Material: Aluminum, Black Anodized

#### MECHANICAL DIMENSIONS

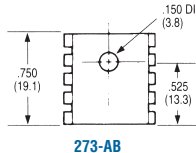

#### 273 SERIES

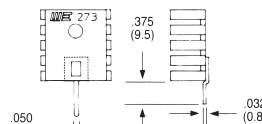
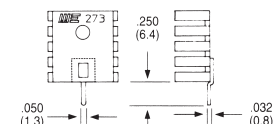
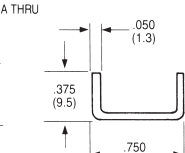

Note:  
1. Suggested Tab Hole =  $\phi$ .075 (1.9) (Plated) with  $\phi$ .100 (2.5) pad

Dimensions: in. (mm)

#### NATURAL AND FORCED CONVECTION CHARACTERISTICS

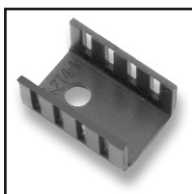
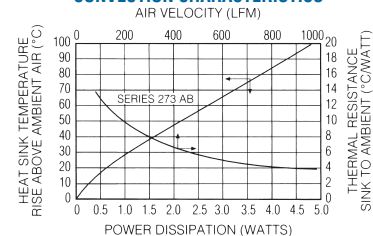

### 274 & 281 SERIES Low-Cost, Low-Height Wavesolderable Heat Sinks

TO-220

Standard P/N	Height Above PC Board in. (mm)	Footprint Dimensions in. (mm)	Mounting Configuration	Solderable Tab Options	Mounting Style	Thermal Performance at Typical Load Natural Convection	Thermal Performance at Typical Load Forced Convection
274-1AB	.375 (9.5)	.520 (13.2) x .750 (19.1)	Vert./Horiz.	No Tab	Mtg Hole	56°C @ 2W	8.0°C/W @ 400 LFM
274-1ABE-01	.375 (9.5)	.520 (13.2) x .750 (19.1)	Vertical	01	Mtg Hole	56°C @ 2W	8.0°C/W @ 400 LFM
274-1ABE-02	.375 (9.5)	.520 (13.2) x .750 (19.1)	Vertical	02	Mtg Hole	56°C @ 2W	8.0°C/W @ 400 LFM
274-2AB	.500 (12.7)	.520 (13.2) x .750 (19.1)	Vert./Horiz.	No Tab	Mtg Hole	50°C @ 2W	7.0°C/W @ 400 LFM
274-2ABE-01	.500 (12.7)	.520 (13.2) x .750 (19.1)	Vertical	01	Mtg Hole	50°C @ 2W	7.0°C/W @ 400 LFM
274-2ABE-02	.500 (12.7)	.520 (13.2) x .750 (19.1)	Vertical	02	Mtg Hole	50°C @ 2W	7.0°C/W @ 400 LFM
274-3AB	.250 (6.4)	.520 (13.2) x .750 (19.1)	Vert./Horiz.	No Tab	Mtg Hole	62°C @ 2W	9.0°C/W @ 400 LFM
274-3ABE-01	.250 (6.4)	.520 (13.2) x .750 (19.1)	Vertical	01	Mtg Hole	62°C @ 2W	9.0°C/W @ 400 LFM
274-3ABE-02	.250 (6.4)	.520 (13.2) x .750 (19.1)	Vertical	02	Mtg Hole	62°C @ 2W	9.0°C/W @ 400 LFM
281-1AB	.375 (9.5)	.520 (13.2) x .750 (19.1)	Vertical	No Tab	Mtg Hole	56°C @ 2W	8.0°C/W @ 400 LFM
281-2AB	.500 (12.7)	.520 (13.2) x .750 (19.1)	Vertical	No Tab	Mtg Hole	50°C @ 2W	7.0°C/W @ 400 LFM

Material: Aluminum, Black Anodized

#### MECHANICAL DIMENSIONS

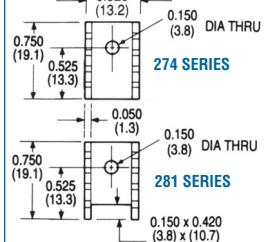

#### 274 SERIES

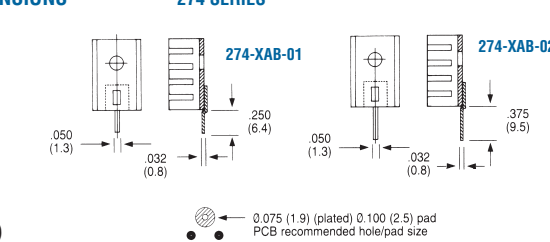
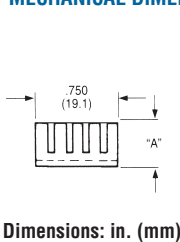

0.075 (1.9) (plated) 0.100 (2.5) pad  
PCB recommended hole/pad size

Dimensions: in. (mm)

#### NATURAL AND FORCED CONVECTION CHARACTERISTICS

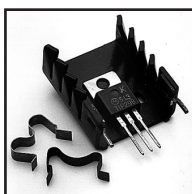
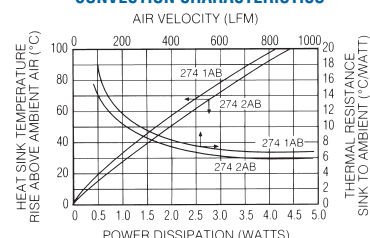

### 240 SERIES Labor-Saving Twisted Fin Heat Sinks

TO-220

Standard P/N	Height Above PC Board in. (mm)	Footprint Dimensions in. (mm)	Mounting Configuration	Solderable Tab Options	Mounting Style	Thermal Performance at Typical Load Natural Convection	Thermal Performance at Typical Load Forced Convection
240-118ABEH-22	1.180 (30.0)	1.000 (25.4) x .500 (12.7)	Vertical	22	Clip/Mtg Hole	55°C @ 4W	5.3°C/W @ 400 LFM
240-118ABES-22	1.180 (30.0)	1.000 (25.4) x .500 (12.7)	Vertical	22	Clip/Mtg Slot	55°C @ 4W	5.3°C/W @ 400 LFM

Material: Aluminum, Black Anodized

#### MECHANICAL DIMENSIONS

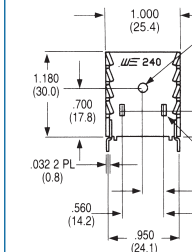

#### 240 SERIES

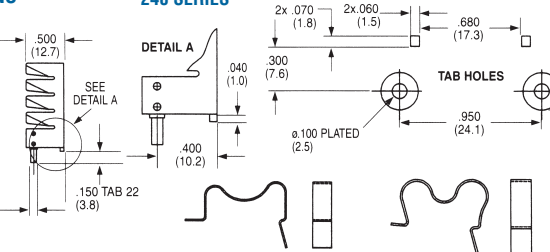
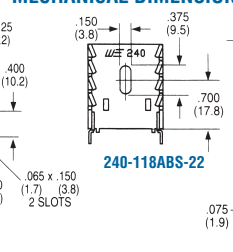

SPRING STEEL 285SC 10# STAINLESS STEEL 330SC 4#  
Order SpeedClips™ Separately

Dimensions: in. (mm)

#### NATURAL AND FORCED CONVECTION CHARACTERISTICS

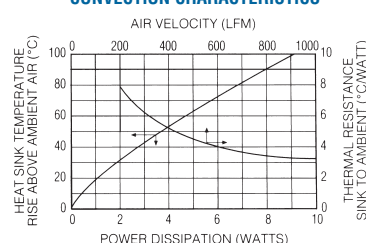



# Board Level Heat Sinks

## BOARD LEVEL POWER SEMICONDUCTOR HEAT SINKS



### 242 SERIES Low-Height, Low-Profile Twisted Fin Heat Sinks

TO-220

Standard P/N	Height Above PC Board in. (mm)	Footprint Dimensions in. (mm)	Mounting Configuration	Solderable Tab Options	Mounting Style	Thermal Performance at Typical Load	
						Natural Convection	Forced Convection
242-125ABE-22	1.285 (32.6)	.875 (22.2) x .250 (6.4)	Vertical	22	Mtg Hole	48°C @ 2W	6.2°C/W @ 400 LFM

Material: Aluminum, Black Anodized

**242-125AB-22 MECHANICAL DIMENSIONS**

Dimensions: in. (mm)

**242 SERIES MECHANICAL DIMENSIONS**

Dimensions: in. (mm)

**NATURAL AND FORCED CONVECTION CHARACTERISTICS**

AIR VELOCITY (LFM)

HEAT SINK TEMPERATURE RISE ABOVE AMBIENT AIR (°C)

THERMAL RESISTANCE SINK TO AMBIENT (°C/WATT)

POWER DISSIPATION (WATTS)



### 232 & 238 SERIES Staggered Fin Heat Sinks for Vertical Mounting

TO-202, TO-220

Standard P/N	Height Above PC Board in. (mm)	Footprint Dimensions in. (mm)	Mounting Configuration	Solderable Tab Options	Mounting Style	Thermal Performance at Typical Load	
						Natural Convection	Forced Convection
232-200AB	2.000 (50.8)	1.380 (35.1) x .500 (12.7)	Vertical	2, Twisted	Clip/Mtg Hole	48°C @ 4W	3.3°C/W @ 400 LFM
232-200ABE-23	2.000 (50.8)	1.380 (35.1) x .500 (12.7)	Vertical	2, Solderable	Clip/Mtg Hole	48°C @ 4W	3.3°C/W @ 400 LFM
238-200AB	2.000 (50.8)	1.380 (35.1) x .500 (12.7)	Vertical	2, Twisted	Mtg Slot	48°C @ 4W	3.3°C/W @ 400 LFM
238-200ABE-23	2.000 (50.8)	1.380 (35.1) x .500 (12.7)	Vertical	2, Solderable	Mtg Slot	48°C @ 4W	3.3°C/W @ 400 LFM

Material: Aluminum, Black Anodized

**232-200AB MECHANICAL DIMENSIONS**

**238-200AB MECHANICAL DIMENSIONS**

**NATURAL AND FORCED CONVECTION CHARACTERISTICS**

AIR VELOCITY (LFM)

HEAT SINK TEMPERATURE RISE ABOVE AMBIENT AIR (°C)

THERMAL RESISTANCE SINK TO AMBIENT (°C/WATT)

POWER DISSIPATION (WATTS)



### 251 SERIES Slim-Profile Heat Sinks With Integral Clips

15 Lead Multiwatt

Standard P/N	Height Above PC Board in. (mm)	Footprint Dimensions in. (mm)	Mounting Configuration	Solderable Tab Options	Mounting Style	Thermal Performance at Typical Load	
						Natural Convection	Forced Convection
251-62AB	.620 (15.7)	.910 (23.1) x .380 (9.7)	Vert./Horiz.	No Tab	Clip	66°C @ 3W	66°C/W @ 400 LFM
251-80AB	.845 (21.5)	.910 (23.1) x .380 (9.7)	Vert./Horiz.	No Tab	Clip	64°C @ 3W	66°C/W @ 400 LFM
251-80ABE-19	.875 (22.2)	.910 (23.1) x .380 (9.7)	Vertical	No Tab	Clip	64°C @ 3W	66°C/W @ 400 LFM

Material: Aluminum, Black Anodized

**251-62AB MECHANICAL DIMENSIONS**

**251-80AB MECHANICAL DIMENSIONS**

**NATURAL AND FORCED CONVECTION CHARACTERISTICS**

AIR VELOCITY (LFM)

HEAT SINK TEMPERATURE RISE ABOVE AMBIENT AIR (°C)

THERMAL RESISTANCE SINK TO AMBIENT (°C/WATT)

POWER DISSIPATION (WATTS)

**BOARD LEVEL HEAT SINKS FOR TO-220, TO-218 AND MULTIWATT™ COMPONENTS**



**244 SERIES** Low Height, Slim Profile Wavesolderable Folded Fin Heat Sinks

MULTIWATT

Standard P/N	Height Above PC Board in. (mm)	Footprint Dimensions in. (mm)	Mounting Configuration	Solderable Tab Options	Thermal Performance at Typical Load		Weight lbs. (grams)
					Natural Convection	Forced Convection	
244-145AB	1.450 (36.8)	1.300 (33.0) x 480 (12.1)	Vert./Horiz.	No Tab	44°C @ 4W	4.4°C/W @ 400 LFM	.0160 (7.25)
244-145ABE-50	1.650 (41.9)	1.300 (33.0) x 480 (12.1)	Vertical	50	44°C @ 4W	4.4°C/W @ 400 LFM	.0170 (7.20)

Material: Aluminum, Black Anodized

**MECHANICAL DIMENSIONS**

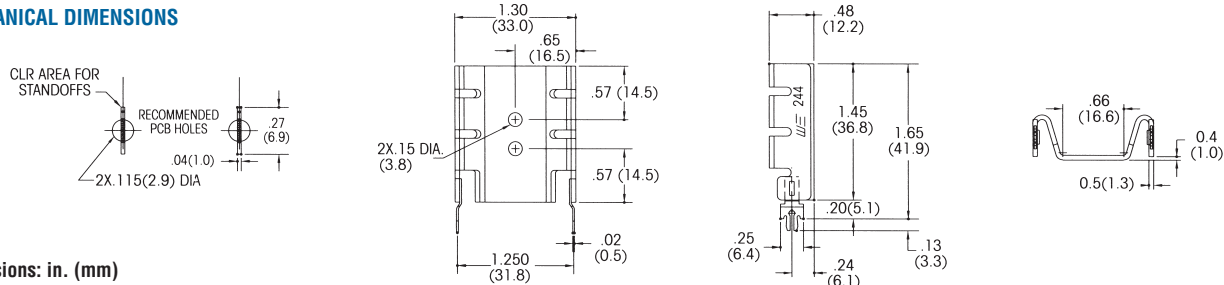

Dimensions: in. (mm)



**245 SERIES** Low Height, Slim Profile Wavesolderable Folded Fin Heat Sinks

MULTIWATT

Standard P/N	Height Above PC Board in. (mm)	Footprint Dimensions in. (mm)	Mounting Configuration	Solderable Tab Options	Thermal Performance at Typical Load		Weight lbs. (grams)
					Natural Convection	Forced Convection	
245-145AB	1.450 (36.8)	1.750 (44.5) x .380 (9.7)	Vert./Horiz.	No Tab	38°C @ 4W	3.2°C/W @ 400 LFM	.0160 (7.25)
245-145ABE-50	1.650 (41.9)	1.750 (44.5) x .380 (9.7)	Vertical	50	38°C @ 4W	3.2°C/W @ 400 LFM	.0170 (7.20)

Material: Aluminum, Black Anodized

**MECHANICAL DIMENSIONS**

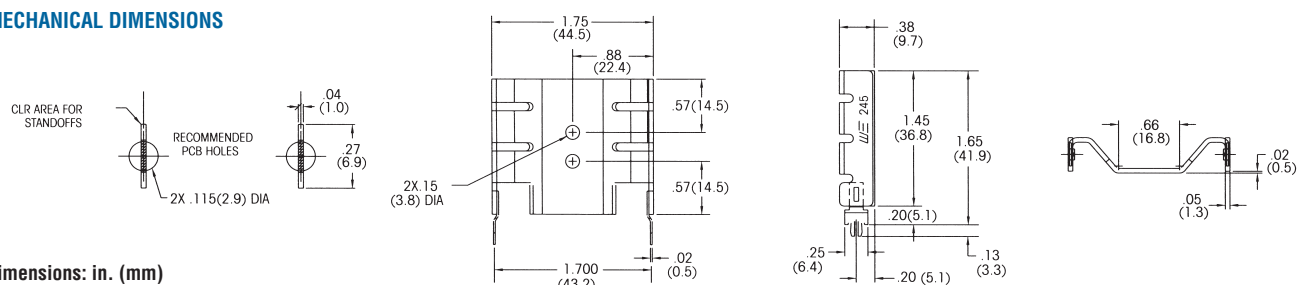

Dimensions: in. (mm)



**246 SERIES** Medium Height, Slim Profile Wavesolderable Folded Fin Heat Sinks

MULTIWATT

Standard P/N	Height Above PC Board in. (mm)	Footprint Dimensions in. (mm)	Mounting Configuration	Solderable Tab Options	Thermal Performance at Typical Load		Weight lbs. (grams)
					Natural Convection	Forced Convection	
246-197AB	1.968 (50.0)	1.986 (50.4) x 3.75 (9.5)	Vert./Horiz.	No Tab	35°C @ 4W	2.8°C/W @ 400 LFM	.0240 (10.90)
246-197ABE-50	2.168 (55.1)	1.986 (50.4) x 3.75 (9.5)	Vertical	50	35°C @ 4W	2.8°C/W @ 400 LFM	.0250 (11.40)

Order SpeedClip™ 285SC or 330SC separately. (See 248 Series section).  
Material: Aluminum, Black Anodized

**MECHANICAL DIMENSIONS**

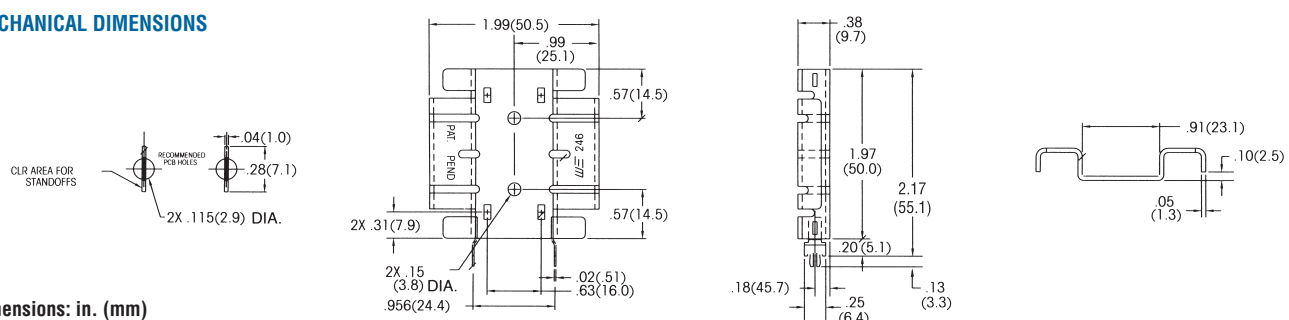

Dimensions: in. (mm)

**Board Level Heat Sinks**

**BOARD LEVEL HEAT SINKS FOR TO-220, TO-218 AND MULTIWATT™ COMPONENTS**



**247 SERIES**

*Medium Height, Deep Profile Wavesolderable Folded Fin Heat Sinks*

MULTIWATT

Standard P/N	Height Above PC Board in. (mm)	Footprint Dimensions in. (mm)	Mounting Configuration	Solderable Tab Options	Thermal Performance at Typical Load Natural Convection	Thermal Performance at Typical Load Forced Convection	Weight lbs. (grams)
247-195AB	1.950 (49.5)	1.900 (48.3) x .950 (24.1)	Vert./Horiz.	No Tab	25°C@ 4W	2.4°C/W @ 400 LFM	.0330 (15.10)
247-195ABE-50	1.950 (49.5)	1.900 (48.3) x .950 (24.1)	Vertical	50	25°C@ 4W	2.4°C/W @ 400 LFM	.0340 (15.60)

Order SpeedClip™ 285SC or 330SC separately. (See 248 Series section).  
Material: Aluminum, Black Anodized

**MECHANICAL DIMENSIONS**

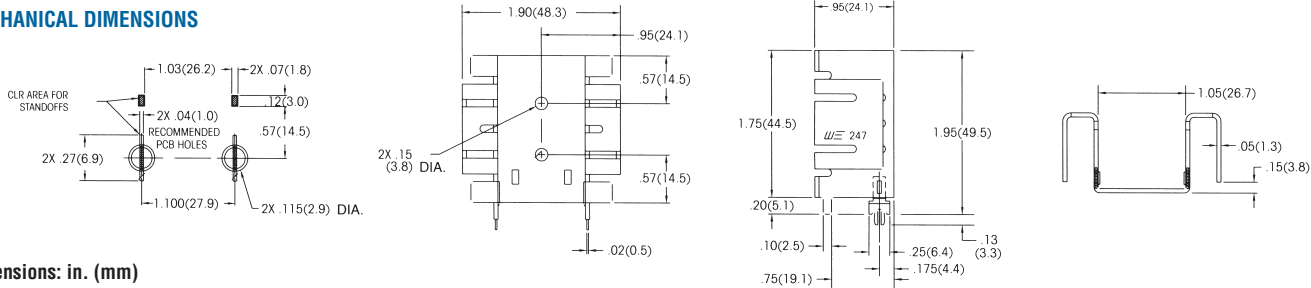

Dimensions: in. (mm)



**248 SERIES**

*Low Height, Medium Profile Wavesolderable Folded Fin Heat Sinks*

MULTIWATT

Standard P/N	Height Above PC Board in. (mm)	Footprint Dimensions in. (mm)	Mounting Configuration	Solderable Tab Options	Thermal Performance at Typical Load Natural Convection	Thermal Performance at Typical Load Forced Convection	Weight lbs. (grams)
248-162AB	1.620 (41.1)	2.000 (50.8) x .750 (19.1)	Vert./Horiz.	No Tab	35°C @ 4W	2.5°C/W @ 400 LFM	.026 (11.60)
248-162ABE-50	1.620 (41.1)	2.000 (50.8) x .750 (19.1)	Vertical	50	35°C @ 4W	2.5°C/W @ 400 LFM	.027 (12.20)

Order SpeedClip™ 285SC or 330SC separately.  
Material: Aluminum, Black Anodized

**MECHANICAL DIMENSIONS**

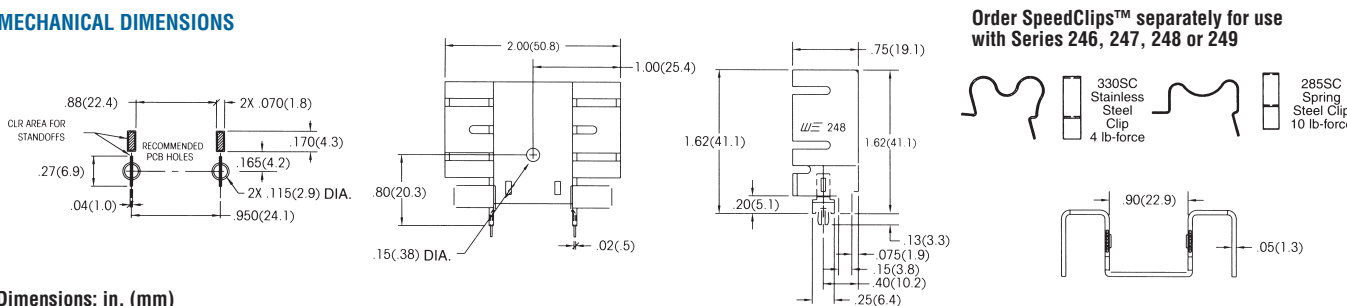

Dimensions: in. (mm)

Order SpeedClips™ separately for use with Series 246, 247, 248 or 249

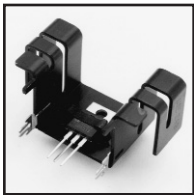
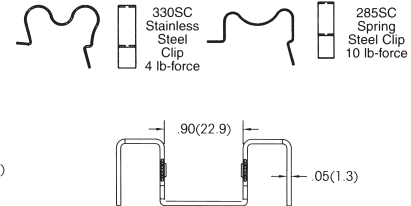

**249 SERIES**

*Medium Height, Deep Profile Wavesolderable Folded Fin Heat Sinks*

MULTIWATT

Standard P/N	Height Above PC Board in. (mm)	Footprint Dimensions in. (mm)	Mounting Configuration	Solderable Tab Options	Thermal Performance at Typical Load Natural Convection	Thermal Performance at Typical Load Forced Convection	Weight lbs. (grams)
249-113AB	1.130 (28.7)	1.900 (48.3) x .950 (24.1)	Vert./Horiz.	No Tab	35°C@ 4W	3.29°C/W @ 400 LFM	.020 (8.90)
249-113ABE-50	1.130 (28.7)	1.900 (48.3) x .950 (24.1)	Vertical	50	35°C@ 4W	3.29°C/W @ 400 LFM	.021 (9.40)

Order SpeedClip™ 285SC or 330SC separately. (See 248 Series section).  
Material: Aluminum, Black Anodized

**MECHANICAL DIMENSIONS**

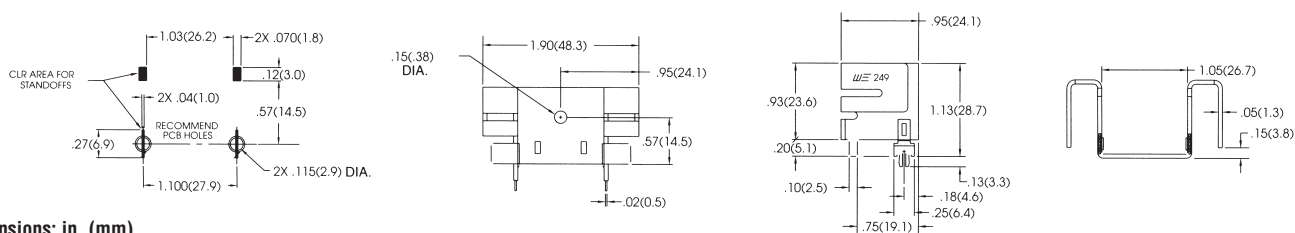

Dimensions: in. (mm)

## BOARD LEVEL POWER SEMICONDUCTOR HEAT SINKS



### 288 SERIES

Compact Wave-Solderable Low-Cost Heat Sinks

TO-220, TO-202

Standard P/N	Height Above PC Board in. (mm)	Maximum Footprint in. (mm)	Thermal Performance at Typical Load		Weight lbs. (grams)
			Natural Convection	Forced Convection	
288-1ABE	1.250 (31.8)	0.875 (22.2) x 0.215 (5.5)	85°C @ 4W	12°C/W @ 200 LFM	0.0057 (2.59)

Mounting tabs are pre-tinned to ensure excellent wave-solder bond and good electrical connections for vertical mounting of TO-220 and TO-202 semiconductor packages. These heat sinks are designed for use where minimum PC board

space is available. The 288-1AB is a stamped aluminum heat sink, black anodized, designed for applications requiring good heat dissipation from a heat sink occupying minimum space, available at minimum cost.

### MECHANICAL DIMENSIONS

### 288 SERIES



Dimensions: in. (mm)

### NATURAL AND FORCED CONVECTION CHARACTERISTICS



### 271 SERIES

Top-Mount Booster Heat Sinks for Use with 270/272/280 Series

TO-220

Standard P/N	Height Above Semiconductor Case in. (mm)	Horizontal Mounting Footprint Dimensions in. (mm)	Thermal Performance at Typical Load		Weight lbs. (grams)
			Natural Convection	Forced Convection	
271-AB	0.500 (12.7)	1.750 (44.5) x 0.700 (17.8)	62°C @ 4W (NOTE A) 31 °C @ 4W (NOTE B)	5.1°C/W @ 400 LFM 1.8°C/W 400 LFM (NOTE B)	0.0052 (2.36)

Material: Aluminum, Black Anodized

This top-hat style booster heat sink can be added to any of the 270, 272, or 280 Series for improved performance.

NOTE A: Thermal resistance with one 271-AB. NOTE B: Thermal resistance (total) as shown with (2) 271-AB types added to (1) 272-AB type.

### MECHANICAL DIMENSIONS

### 271 SERIES



Dimensions: in. (mm)

### NATURAL AND FORCED CONVECTION CHARACTERISTICS





# Board Level Heat Sinks

## BOARD LEVEL POWER SEMICONDUCTOR HEAT SINKS



### 270/272/280 SERIES

### Small Footprint Low-Cost Heat Sinks

TO-220, TO-202

Standard P/N	Height Above PC Board in. (mm)	Horizontal Mounting Maximum Footing in. (mm)	Solderable Tab Options	Thermal Performance at Typical Load		Weight lbs. (grams)
				Natural Convection	Forced Convection	
270-AB	0.375 (9.4)	1.750 (44.5) x 0.700 (17.8)	—	70°C @ 4W	6.0°C/W @ 400 LFM	0.0052 (2.36)
272-AB	0.375 (9.4)	1.750 (44.5) x 1.450 (36.8)	01,02	42°C @ 4W	3.6°C/W @ 400 LFM	0.0105 (5.72)
280-AB	0.375 (9.4)	1.750 (44.5) x 0.700 (17.8)	—	70°C @ 4W	6.0°C/W @ 400 LFM	0.0048 (2.18)

Material: Aluminum, Black Anodized

These exceptionally low-cost heat sinks can be mounted horizontally under a TO-220 or TO-202 case style with a maximum height of only 0.375 in. (9.4). For added performance, a 271 Series heat sink can also be used for double-sided heat dissipation.

The 270-AB and 280-AB accept one power semiconductor; the 272-AB is designed for two power semiconductors. Specify solderable tab options for the 272 Series by the addition of suffix "01" or "02" to the standard part number (i.e. 272-AB01 or 272-AB02).

### MECHANICAL DIMENSIONS



270 SERIES

280 SERIES



272 SERIES



### NATURAL AND FORCED CONVECTION CHARACTERISTICS

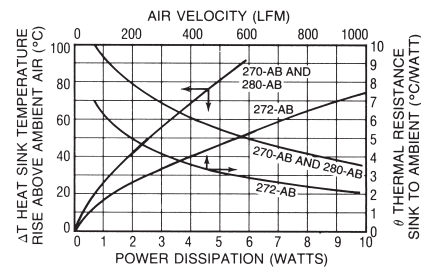

272AB01

272AB02

Dimensions: in. (mm)

Note:  
1. Suggested Tab Hole = 0.075 ±0.003 plated with 0.100 pad



### 289 & 290 SERIES

### Low-Cost Single or Dual Package Heat Sinks

TO-218, TO-202, TO-220

Standard P/N	Height Above PC Board in. (mm)	Horizontal Mounting Maximum Footing in. (mm)	Thermal Performance at Typical Load		Weight lbs. (grams)
			Natural Convection	Forced Convection	
289-AB	0.500 (12.7)	1.000 (25.4) x 0.710 (18.1)	50°C @ 2W	9.0 C/W @ 400 LFM	0.0055 (2.49)
289-AP	0.500 (12.7)	1.000 (25.4) x 0.710 (18.1)	50°C @ 2W	9.0 C/W @ 400 LFM	0.0055 (2.49)
290-1AB	0.500 (12.7)	1.000 (25.4) x 1.180 (30.0)	44°C @ 2W	7.0 C/W @ 400 LFM	0.0082 (3.72)
290-2AB	0.500 (12.7)	1.000 (25.4) x 1.180 (30.0)	44°C @ 2W	7.0 C/W @ 400 LFM	0.0081 (3.67)

Material: Aluminum, Black Anodized

Low in cost and compact in overall dimensions, one 289 Series heat sink can accommodate one semiconductor; the 289 Series is available with a black an-

odized finish (289-AB) or with no finish (289-AP). Two semiconductors can be mounted to the 290-2AB style.

### 289 SERIES

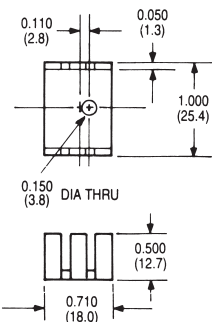

### MECHANICAL DIMENSIONS

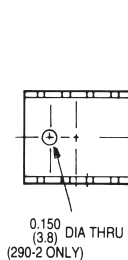

### 290 SERIES

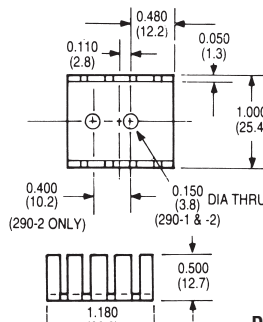

Dimensions: in. (mm)

### NATURAL AND FORCED CONVECTION CHARACTERISTICS

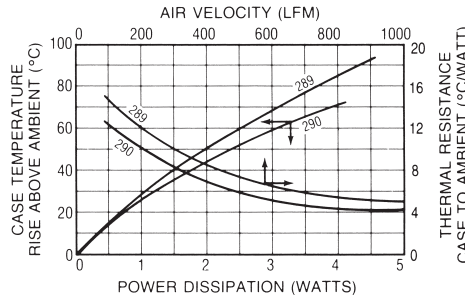



## BOARD LEVEL POWER SEMICONDUCTOR HEAT SINKS

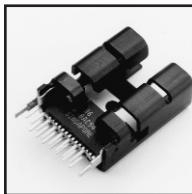

### 250 SERIES

High-Performance Slim Profile Heat Sinks With Integral Clips

MULTIWATT

Standard P/N	Height Above PC Board in. (mm)	Footprint Dimensions in. (mm)	Mounting Configuration	Solderable Tab Options	Mounting Style	Thermal Performance at Typical Load	
						Natural Convection	Forced Convection
250-122AB	1.220 (31.0)	1.000 (25.4) x .500 (12.7)	Vert./Horiz.	No Tab	Clip	50°C @ 4W	3.7°C/W @ 400 LFM
250-122ABE-09	1.220 (31.0)	1.000 (25.4) x .500 (12.7)	Vertical	09	Clip	50°C @ 4W	3.7°C/W @ 400 LFM
250-122ABE-25	1.380 (35.1)	1.000 (25.4) x .500 (12.7)	Vertical	25	Clip	50°C @ 4W	3.7°C/W @ 400 LFM

Material: Aluminum, Black Anodized

### MECHANICAL DIMENSIONS

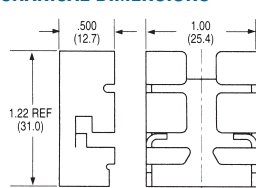

250-122AB  
Dimensions: in. (mm)

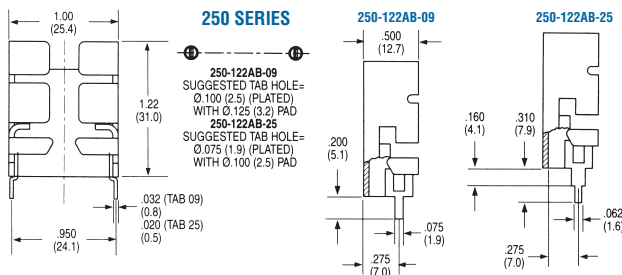

### NATURAL AND FORCED CONVECTION CHARACTERISTICS

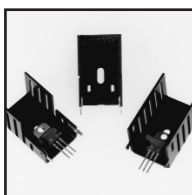
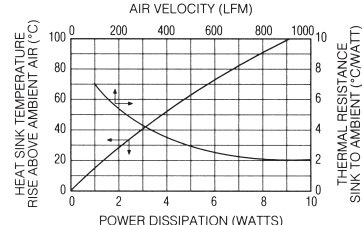

### 237 & 252 SERIES

High-Performance, High-Power Vertical Mount Heat Sinks

TO-220

Standard P/N	Height Above PC Board in. (mm)	Footprint Dimensions in. (mm)	Mounting Configuration	Solderable Tab Options	Mounting Style	Thermal Performance at Typical Load	
						Natural Convection	Forced Convection
237-167AB2	1.675 (42.5)	1.000 (25.4) x 1.000 (25.4)	Vertical	2, Twisted	Clip/Mtg Slot	46°C @ 4W	4.5°C/W @ 200 LFM
237-167AB3	1.675 (42.5)	1.000 (25.4) x 1.000 (25.4)	Vertical	3, Twisted	Clip/Mtg Slot	46°C @ 4W	4.5°C/W @ 200 LFM
237-167ABE2-24	1.675 (42.5)	1.000 (25.4) x 1.000 (25.4)	Vertical	2, Solderable	Clip/Mtg Slot	46°C @ 4W	4.5°C/W @ 200 LFM
252-167AB2	1.675 (42.5)	1.000 (25.4) x 1.000 (25.4)	Vertical	2, Twisted	Clip/Mtg Slot	40°C @ 4W	4.5°C/W @ 200 LFM
252-167AB3	1.675 (42.5)	1.000 (25.4) x 1.000 (25.4)	Vertical	3, Twisted	Clip/Mtg Slot	40°C @ 4W	4.5°C/W @ 200 LFM
252-167ABE2-24	1.675 (42.5)	1.000 (25.4) x 1.000 (25.4)	Vertical	2, Solderable	Clip/Mtg Slot	40°C @ 4W	4.5°C/W @ 200 LFM

Order SpeedClips™ 285SC or 330SC separately for rapid component installation, lowering manufacturing costs. Material: Aluminum, Black Anodized

### MECHANICAL DIMENSIONS

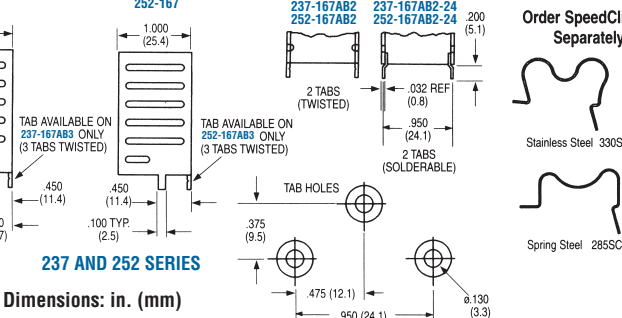
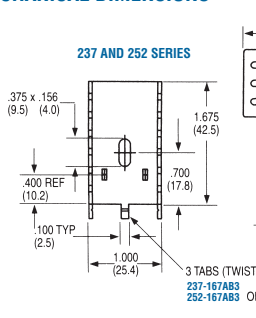

### NATURAL AND FORCED CONVECTION CHARACTERISTICS

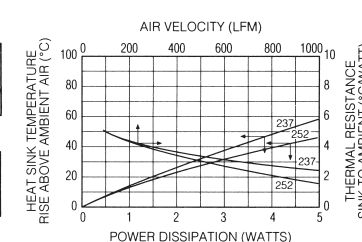

### 291 SERIES

Labor-Saving Clip-on Heat Sinks

TO-220

Standard P/N	Height Above PC Board in. (mm)	Mounting Footprint Dimensions in. (mm)	Mounting Style	Thermal Performance at Typical Load		Weight lbs. (grams)
				Natural Convection	Forced Convection	
291-C236AB	0.860 (21.9)	1.100 (27.0) x 0.360 (9.1)	TO-220 (Clip)	80°C @ 2W	24°C/W @ 600 LFM	0.0026 (1.18)
291-H36AB	0.860 (21.9)	1.100 (27.0) x 0.360 (9.1)	TO-220 (Mtg. Hole)	68°C @ 2W	16°C/W @ 600 LFM	0.0026 (1.18)

Material: Aluminum, Black Anodized

Designed for mounting horizontally or vertically on a circuit board, 291 Series heat sinks employ a unique clip for attachment of TO-220 case styles.

One type is available with a locking clip and one with a 0.140 in. (3.6) diameter mounting hole only.

### MECHANICAL DIMENSIONS

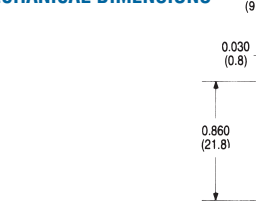

Dimensions: in. (mm)

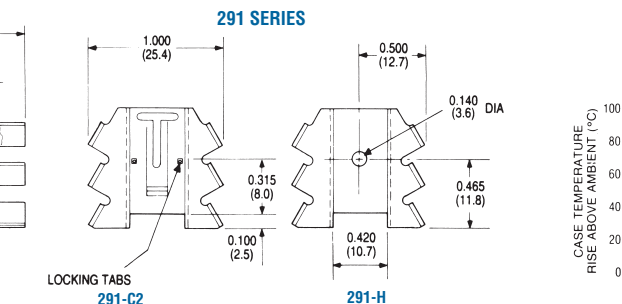

### NATURAL AND FORCED CONVECTION CHARACTERISTICS

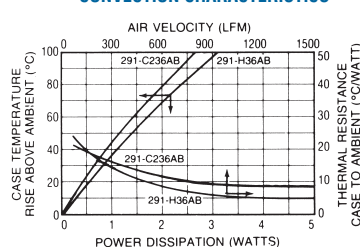

**Board Level Heat Sinks**

**BOARD LEVEL POWER SEMICONDUCTOR HEAT SINKS**

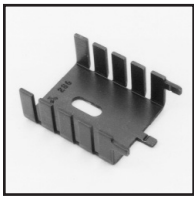

**286 SERIES**

**Aluminum and Copper Low-Cost Wave-Solderable Heat Sinks**

See also 286DB Series on Page 7.

TO-220

Standard P/N	Height Above PC Board in. (mm)	Maximum Footprint in. (mm)	Material	Thermal Performance at Typical Load		Weight lbs. (grams)
				Natural Convection	Forced Convection	
286-AB	1.190 (30.2)	1.000 (25.4) x 0.500 (12.7)	Aluminum, Anodized	58°C @ 4W	7.4°CW @ 200 LFM	0.0085 (3.86)
286-CBTE	1.190 (30.2)	1.000 (25.4) x 0.500 (12.7)	Copper, Black	58°C @ 4W	7.4°CW @ 200 LFM	0.0250 (11.34)
286-CTE	1.190 (30.2)	1.000 (25.4) x 0.500 (12.7)	Copper, Tinned	58°C @ 4W	7.4°CW @ 200 LFM	0.0250 (11.34)

Efficient heat removal at low cost can be achieved by inserting the 286 Series directly into pre-drilled circuit boards; scored mounting tabs may be bent after insertion to provide added stability. The 286 Series can be wavesoldered directly to

the board. Material: 286-AB style (aluminum, black anodized), 286-CBT style (copper, black paint tin tabs), and 286-CT style (copper, tinned).

**MECHANICAL DIMENSIONS**

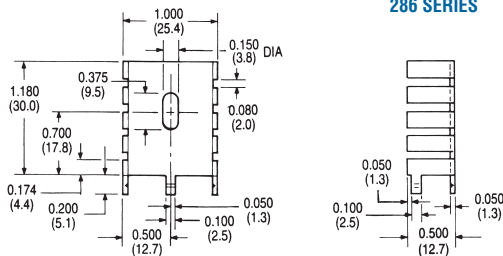

Dimensions: in. (mm)

**NATURAL AND FORCED CONVECTION CHARACTERISTICS**

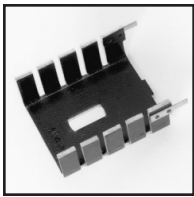
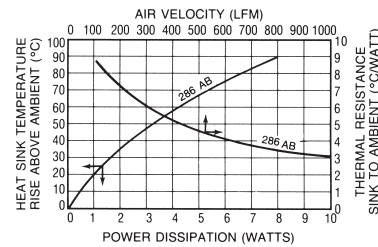

**287 SERIES**

**Wave-Solderable Low-Cost Heat Sinks**

TO-220

Standard P/N	Mounting Slot	Mounting Hole	Height Above PC Board in. (mm)	Maximum Footprint "A" in. (mm)	Thermal Performance at Typical Load		Weight lbs. (grams)
					Natural Convection	Forced Convection	
287-1ABE	287-1ABH	287-1ABH	1.180 (30.0)	1.000 (25.4) x 0.500 (12.7)	65°C @ 4W	7.8°CW @ 200 LFM	0.0090 (4.08)
287-2ABE	287-2ABH	287-2ABH	1.180 (30.0)	1.000 (25.4) x 1.000 (25.4)	55°C @ 4W	6.4°CW @ 200 LFM	0.0140 (6.35)

Material: Aluminum, Black Anodized

Mount these cost-effective TO-220 heat sinks vertically into pre-drilled printed circuit boards. Soldered, pre-tinned tabs can be wavesoldered directly to the

board. A 0.375 in. (9.5 mm) mounting slot allows for correct positioning of TO-220 and similar semiconductor packages.

**MECHANICAL DIMENSIONS**

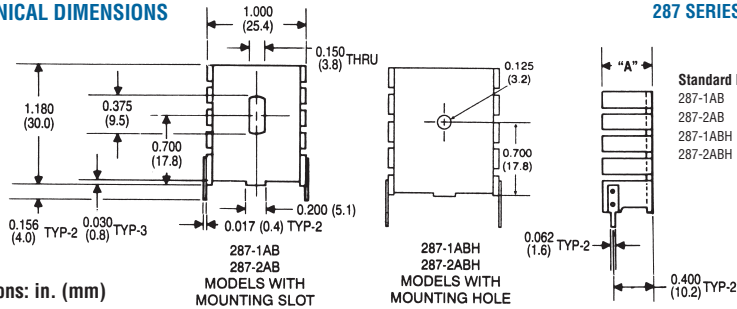

Dimensions: in. (mm)

**NATURAL AND FORCED CONVECTION CHARACTERISTICS**

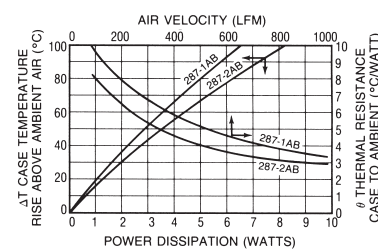

**285 & 330 SERIES**

**285 SC and 330 SC SpeedClips™**

Standard P/N	Nominal Installed Loading Force	For Use With Series	Material	Weight lbs. (grams)
285 SC	10 lbs	232, 237, 240, 252, 667	Carbon Steel	0.00053 (0.24)
330 SC	4 lbs	232, 237, 240, 252, 667	Stainless Steel	0.00074 (0.34)

SpeedClips™ employ a locking safety tab for mounting. Must be ordered separately for these heat sink series. Use these SpeedClips™ with our 237, 240, and 252 Series heat sinks for the lowest production assembly time and cost. Order

one SpeedClip™ for each heat sink purchased. Must be purchased with heat sinks.

**MECHANICAL DIMENSIONS**

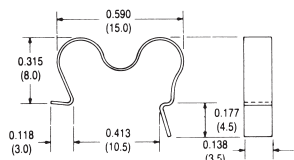

**Speed Clip 330 SC**  
4 lb (17.8N) Nominal Force Installed

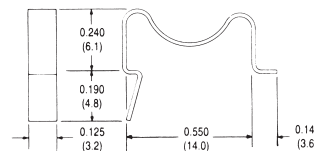

**Speed Clip 285 SC**  
10 lb (44.5N) Nominal Force Installed

Dimensions: in. (mm)

## BOARD LEVEL POWER SEMICONDUCTOR HEAT SINKS

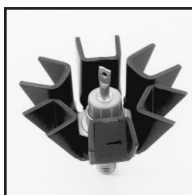

### 695 SERIES

Space-Saving Heat Sinks for Small Stud-Mounted Diodes

STUD-MOUNT

Standard P/N	Maximum Width in. (mm)	Height in. (mm)	Thermal Performance at Typical Load		Weight lbs. (grams)
			Natural Convection	Forced Convection	
695-1B	1.330 (33.8)	0.530 (13.7)	72°C @ 4.0W	5.2°C/W @ 400 LFM	0.008 (4.0)

Mount and effectively heat sink small stud-mounted diodes with the 695 Series space-saving heat sink type. Each unit is black anodized aluminum with an 0.200 in. (5.1) dia. mounting hole centered in the base. The folded fin design

provides good heat dissipation for use where height is limited above the printed circuit board or base plate.

### MECHANICAL DIMENSIONS

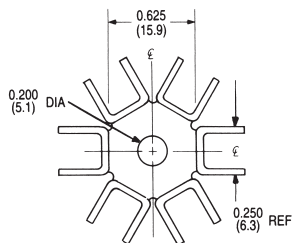

Dimensions: in. (mm)

### 695 SERIES

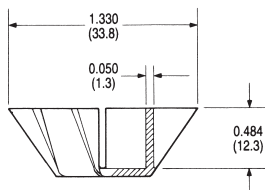

### NATURAL AND FORCED CONVECTION CHARACTERISTICS

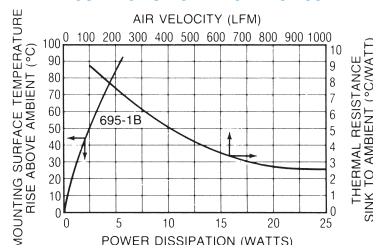

### 260 SERIES

Cup Clips for TO-5 Case Style Semiconductors

TO-5

Characteristics	TO-5
Thermal Resistance – Epoxy Insulated	14° C/W
Breakdown Voltage – Epoxy Type (VAC), 60 Hz	500
Recommended Operating Voltage, AC or DC	
Clean Conditions: % Hipot Rating	50
Dusty Conditions: % Hipot Rating	30
Dirty Conditions: % Hipot Rating	10 to 20
Temperature Range — Continuous (C°)	-73/+149

Model	Depth of Tapped Base
260-4T5E	0.093 (2.36)
260-4TH5E	0.125 (3.18)

**Thread Size:**  
4 = #4-40 UNC  
6 = #6-32 UNC

**Mounting Style:**  
T = tapped  
S = stud  
P = plain

**Base Style:** H = hex  
**Semiconductor Case Style:** 5 = TO-5  
**Insulation:** E = epoxy



### TO-5 CASE STYLE CUP CLIPS — ORDERING GUIDE

Standard P/N	Insulation Type	Outline Dimension L x W x I.D. in. (mm)	Weight lbs. (grams)	Case Style
260-4T5E	Epoxy Insulated	0.370 (9.4) x 0.380 (9.7) dia. x 0.290 (7.4)	0.0024 (1.09)	TO-5
260-4TH5E	Epoxy Insulated	0.400 (10.2) x 0.370 (9.4) hex. x 0.290 (7.4)	0.0031 (1.41)	TO-5
260-6SH5E	Epoxy Insulated	0.557 (14.1) x 0.370 (9.4) hex. x 0.290 (7.4)	0.0037 (1.68)	TO-5

Materials and Finish: Cups – beryllium copper, black ebonol “C”; Bases – brass, black ebonol “C”

### Base Mounting Configurations — TO-5

**Plain Type** — Epoxy bonded, or used with #4 pan head screws.

**Tapped Base** — #4-40 UNC screw (not supplied) fits tapped hole. Care should be taken not to use too long a screw, which could short against the semiconductor case. For correct screw lengths:

Correct Screw Length (L) =  $\text{Depth of Base} + \text{Panel Thickness} + \text{Washer Thickness}$

**Stud Mounting Base.** #6-32 UNC. Nuts and washers not supplied. Stud hole must be slightly countersunk to ensure flat mounting.

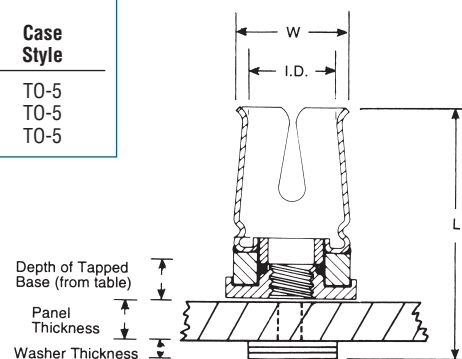
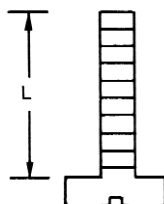

To determine the correct mounting screw lengths, add dimensions as follows:

Correct Screw Length (L) =  $\text{Depth of Base} + \text{Panel Thickness} + \text{Washer Thickness}$

**Board Level Heat Sinks**

**BOARD LEVEL POWER SEMICONDUCTOR HEAT SINKS**

**260 SERIES Epoxy Insulated For TO-5**

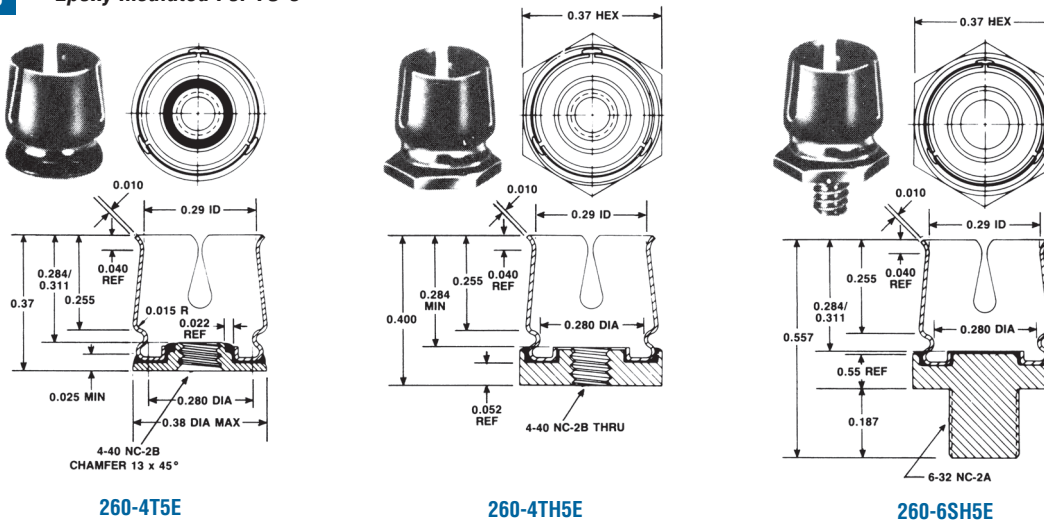

**260-4T5E**

**260-4TH5E**

**260-6SH5E**

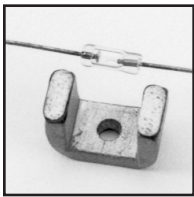

**258 SERIES Thermal Links for Fused Glass Diodes**

DIODES

Standard P/N	Dimensions in. (mm)	Material	Finish	Weight lbs. (grams)
258	0.500 (12.7) x 0.250 (6.4) x 0.340 (8.6)	Aluminum	DeltaCoate™ 151 on all surfaces except solder pads and base	0.0018 (0.82)

The thermal resistance from diode leads to chassis or heat sink is 12°C/watt, when unit is mounted with TYPE 120 Joint Compound. If a 10°C/watt chassis or

sink to ambient impedance is available, the thermal resistance from the diode leads to ambient is reduced from about 150°C/watt to 22°C/watt.

**MECHANICAL DIMENSIONS**

258 SERIES

Dimensions: in. (mm)

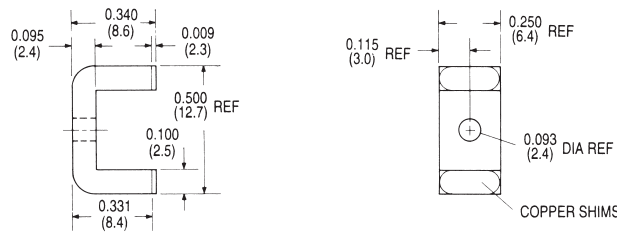

**292 SERIES Heat Sink for Single TO-92**

TO-92

Standard P/N	Height Above PC Board in. (mm)	Overall Fin Width in. (mm)	Thermal Performance Natural Convection	Finish	Weight lbs. (grams)
292-AB	0.750 (19.1)	0.600 (15.3)	0.225°C/W @ 0.250 W	Black Anodized	0.00049 (0.22)

Power semiconductors packaged in a TO-92 style plastic case can be cooled effectively at little additional cost with the addition of the 292-AB heat sink. The

292-AB is effective over the typical power range of such devices. Material: Aluminum, Black Anodized

**MECHANICAL DIMENSIONS**

Dimensions: in. (mm)

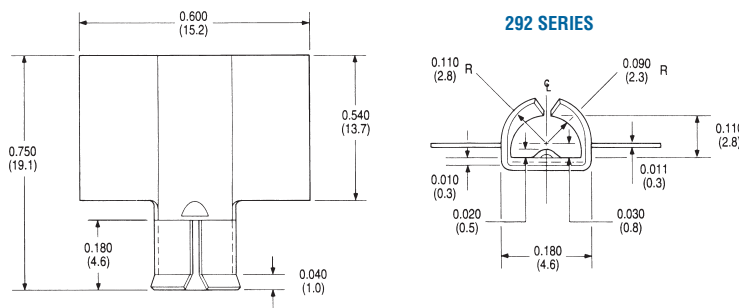

292 SERIES

**NATURAL AND FORCED CONVECTION CHARACTERISTICS**

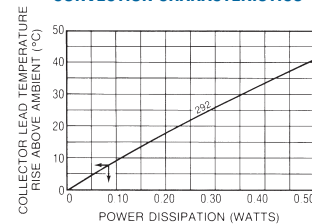

## BOARD LEVEL POWER SEMICONDUCTOR HEAT SINKS

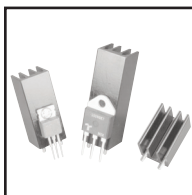

### 634 SERIES Slim Profile Unidirectional Fin Vertical Mount Heat Sink

TO-220 and TO-218

Plain Pin	Standard P/N		Height Above PC Board in. (mm)	Footprint Dimensions in. (mm)	Weight lbs. (grams)
	Without Pin	With Pin			
634-10ABEP	634-10AB		1.000 (25.4)	0.640 (16.26) x 0.640 (16.26)	0.016 (7.48)
634-15ABEP	634-15AB		1.500 (38.1)	0.640 (16.26) x 0.640 (16.26)	0.025 (11.21)
634-20ABEP	634-20AB		2.000 (50.8)	0.640 (16.26) x 0.640 (16.26)	0.033 (14.95)

Material: Aluminum, Black Anodized.

These slim profile unidirectional fin heat sinks offer users two assembly alternatives for vertically mounting TO-220 and TO-218 components. Models are available with or without wave-

solderable pins on 0.40 in. (10.2) centers, making them ideal for a variety of applications where quick assembly is needed and space is at a premium.

#### MECHANICAL DIMENSIONS

#### 634 SERIES

##### Notes:

1. Thermal compound is assumed between device and heat sink.
2. Tab temp with longer heat sink (634-20ABP) will typically be about 15% cooler. Tab temp with shorter heat sink (634-10ABP) will typically be about 25% higher.

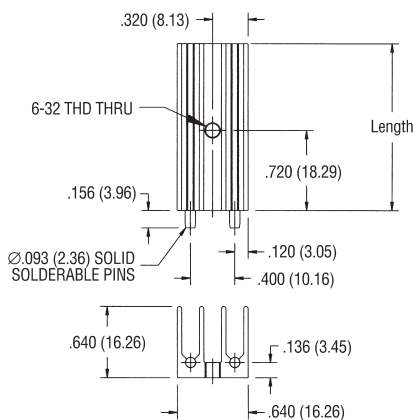

Dimensions: in. (mm)

#### TYPICAL THERMAL PERFORMANCE FOR 634-15ABP

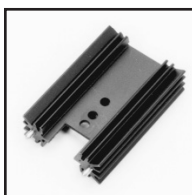
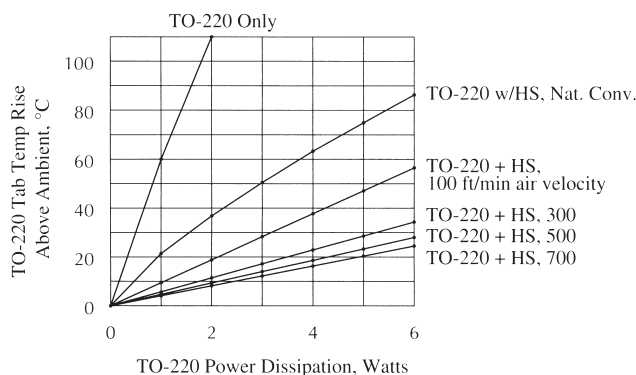

### 637 SERIES High-Efficiency Heat Sinks For Vertical Board Mounting

TO-220

Standard P/N	Height Above PC Board "A" in. (mm)	Maximum Footprint in. (mm)	Thermal Performance at Typical Load		Weight lbs. (grams)
			Natural Convection	Forced Convection	
637-10ABEP	1.000 (25.4)	1.375 (34.9) x 0.500 (12.7)	76°C @ 6W	5.8°C/W @ 200 LFM	0.023 (10.43)
637-15ABEP	1.500 (38.1)	1.375 (34.9) x 0.500 (12.7)	65°C @ 6w	5.5°C/W @ 200 LFM	0.035 (15.88)
637-20ABEP	2.000 (50.8)	1.375 (34.9) x 0.500 (12.7)	55°C @ 6W	4.7°C/W @ 200 LFM	0.050 (22.68)
637-25ABEP	2.500 (63.5)	1.375 (34.9) x 0.500 (12.7)	48°C @ 6W	4.2°C/W @ 200 LFM	0.062 (28.12)

Material: Aluminum, Black Anodized

Wave-solderable pins on 1 in. centers for vertical mounting on printed circuit boards. Maximum semiconductor package width 0.625 in. (15.9). Use this heat sink where weight and

board space occupied must be minimized. Refer to the Accessory products section for thermal interface materials, thermal compounds, and other accessories products.

#### MECHANICAL DIMENSIONS

#### 637 SERIES (EXTRUSION PROFILE 5183)

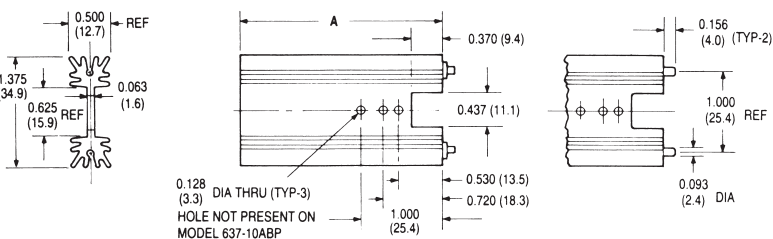

Dimensions: in. (mm)

#### NATURAL AND FORCED CONVECTION CHARACTERISTICS

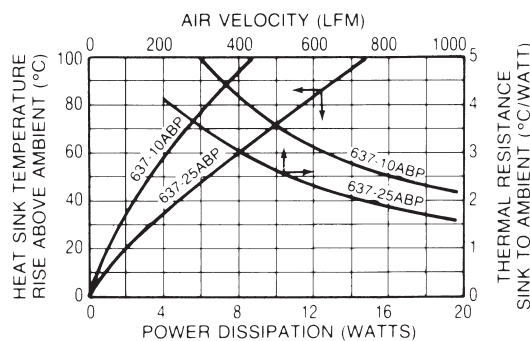



**Board Level Heat Sinks**

**BOARD LEVEL POWER SEMICONDUCTOR HEAT SINKS**

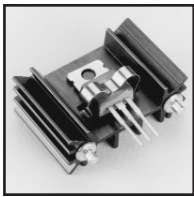

**667 SERIES Labor-Saving SpeedClip™ Heat Sinks for Vertical Board Mounting**

TO-220

Standard P/N Standoff Pin	Standard P/N Plain Pin	Height Above PC Board "A" in. (mm)	Maximum Footprint in. (mm)	Thermal Performance at Typical Load		Weight lbs (grams)
				Natural Convection	Forced Convection	
667-10ABESP	667-10ABPP	1.000 (25.4)	1.375 (34.9) x 0.500 (12.7)	76°C @ 6W	5.8°C/W @ 200 LFM	0.0240 (11.0)
667-15ABESP	667-15ABPP	1.500 (38.1)	1.375 (34.9) x 0.500 (12.7)	66°C @ 6W	5.5°C/W @ 200 LFM	0.0340 (15.6)
667-20ABESP	667-20ABPP	2.000 (50.8)	1.375 (34.9) x 0.500 (12.7)	58°C @ 6W	4.7°C/W @ 200 LFM	0.0460 (21.0)
667-25ABESP	667-25ABPP	2.500 (63.5)	1.375 (34.9) x 0.500 (12.7)	48°C @ 6W	4.2°C/W @ 200 LFM	0.0580 (26.2)

**Wave-solderable pins.** Material: Aluminum, Black Anodized

Excellent performance, choice of wave-solderable plain pins (PP-Type) or wave-solderable hex-shaped standoff pins (SP-Type), and reduced assembly cost.  
**Note:** Order 330 SC or 285 SC SpeedClip™ separately.

**MECHANICAL DIMENSIONS**

Dimensions: in. (mm)

**667 SERIES**  
(EXTRUSION PROFILE 8073)

**NATURAL AND FORCED CONVECTION CHARACTERISTICS**

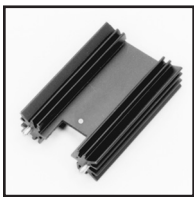

**626 & 627 SERIES High-Efficiency Heat Sinks for Vertical Board Mounting**

TO-218, TO-220

Standard P/N	Standard P/N	Height Above PC Board "A" in. (mm)	Maximum Footprint in. (mm)	Thermal Performance at Typical Load	
				Natural Convection	Forced Convection
626-10ABEP	627-10ABP	1.000 (25.4)	1.375 (34.9) x .500 (12.7)	76°C @ 6W	5.8°C/W @ 200 LFM
626-15ABEP	627-15ABP	1.500 (38.1)	1.375 (34.9) x .500 (12.7)	65°C @ 6W	5.5°C/W @ 200 LFM
626-20ABEP	627-20ABP	2.000 (50.8)	1.375 (34.9) x .500 (12.7)	55°C @ 6W	4.7°C/W @ 200 LFM
626-25ABEP	627-25ABP	2.500 (63.5)	1.375 (34.9) x .500 (12.7)	48°C @ 6W	4.2°C/M @ 200 LFM

**Wave-solderable pins.** Material: Aluminum, Black Anodized

**MECHANICAL DIMENSIONS**

Dimensions: in. (mm)

**626 AND 627 SERIES**

**NATURAL AND FORCED CONVECTION CHARACTERISTICS**

Series	Type Device	Hole Diameter "B"	Hole Height "C"	Webb Width "D"	Notch Width "E"	Extrusion Profile
626	TO-218	.144 (3.7)	.850 (21.6)	.660 (16.8)	.540 (13.7)	8420
627	TO-220	.128 (3.3)	.720 (18.3)	.625 (15.9)	.437 (11.1)	5183

## BOARD LEVEL POWER SEMICONDUCTOR HEAT SINKS

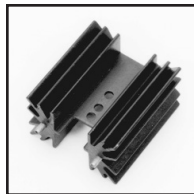

### 647 SERIES High-Performance Heat Sinks for Vertical Board Mounting

TO-220

Standard P/N	Height Above PC Board "A" in. (mm)	Maximum Footprint in. (mm)	Thermal Performance at Typical Load		Weight lbs. (grams)
			Natural Convection	Forced Convection	
647-10ABEP	1.000 (25.4)	1.650 (41.9) x 1.000 (25.4)	42°C @ 6W	3.8°C/W @ 200 LFM	0.055 (24.95)
647-15ABEP	1.500 (38.1)	1.650 (41.9) x 1.000 (25.4)	37°C @ 6W	3.5°C/W @ 200 LFM	0.075 (34.02)
647-175ABEP	1.750 (44.5)	1.650 (41.9) x 1.000 (25.4)	34°C @ 6W	3.3°C/W @ 200 LFM	0.090 (40.82)
647-20ABEP	2.000 (50.8)	1.650 (41.9) x 1.000 (25.4)	31°C @ 6W	3.1°C/W @ 200 LFM	0.104 (47.17)
647-25ABEP	2.500 (63.5)	1.650 (41.9) x 1.000 (25.4)	25°C @ 6W	2.8°C/W @ 200 LFM	0.125 (56.70)

Material: Aluminum, Black Anodized

Wave-solderable pins on 1 in. centers for vertical mounting of larger devices on printed circuit boards. Maximum semiconductor package width: 0.625 (15.9). Refer to the Accessory

Products section for thermal interface materials, 126 Series silicone-free thermal compounds, and other accessories products.

#### MECHANICAL DIMENSIONS

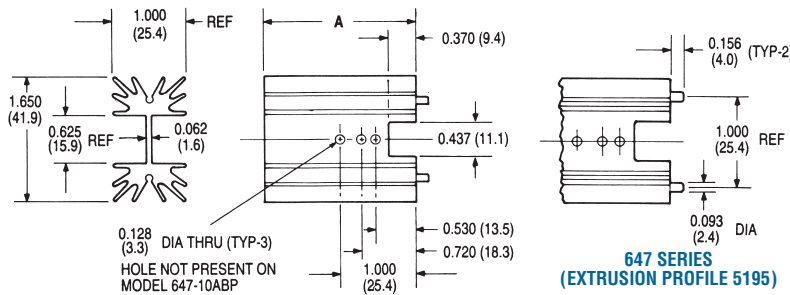

#### NATURAL AND FORCED CONVECTION CHARACTERISTICS

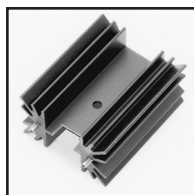
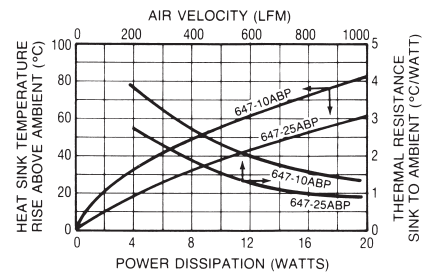

### 657 SERIES High-Performance Heat Sinks for Vertical Board Mounting

TO-220, TO-247, TO-218

Standard P/N	Height Above PC Board "A" in. (mm)	Maximum Footprint in. (mm)	Thermal Performance at Typical Load		Weight lbs. (grams)
			Natural Convection	Forced Convection	
657-10ABEP	1.000 (25.4)	1.650 (41.9) x 1.000 (25.4)	41°C @ 6W	3.7°C/W @ 200 LFM	0.0515 (23.36)
657-15ABEP	1.500 (38.1)	1.650 (41.9) x 1.000 (25.4)	38°C @ 6W	3.3°C/W @ 200 LFM	0.0760 (34.60)
657-20ABEP	2.000 (50.8)	1.650 (41.9) x 1.000 (25.4)	32°C @ 6W	2.9°C/W @ 200 LFM	0.1030 (47.00)
657-25ABEP	2.500 (63.5)	1.650 (41.9) x 1.000 (25.4)	25°C @ 6W	2.7°C/W @ 200 LFM	0.1250 (57.00)

Wave-solderable pins. Material: Aluminum, Black Anodized

#### MECHANICAL DIMENSIONS

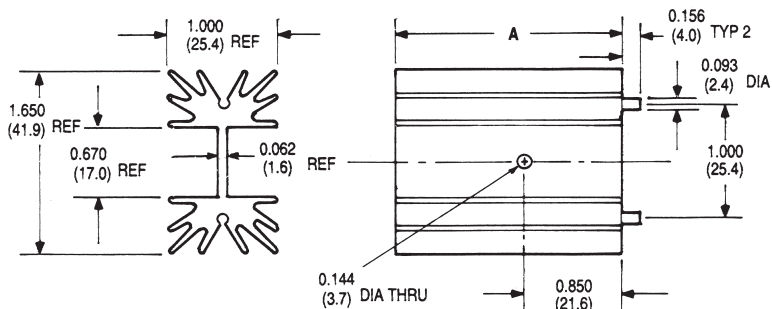

#### NATURAL AND FORCED CONVECTION CHARACTERISTICS

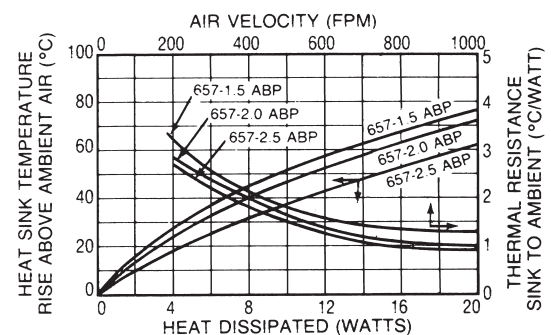

**Board Level Heat Sinks**

**BOARD LEVEL POWER SEMICONDUCTOR HEAT SINKS**

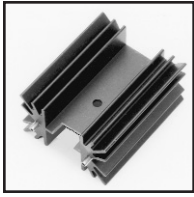

**657 SERIES High-Performance Notched Heat Sinks for Vertical Board Mounting**

TO-220, TO-247, TO-218

Standard P/N	Height Above PC Board "A" in. (mm)	Maximum Footprint in. (mm)	Thermal Performance at Typical Load Natural Convection	Thermal Performance at Typical Load Forced Convection
657-10ABEPN	1.000 (25.4)	1.650 (41.9) x 1.000 (25.4)	41°C @ 6W	3.7°C/W @ 200 LFM
657-15ABEPN	1.500 (38.1)	1.650 (41.9) x 1.000 (25.4)	38°C @ 6W	3.3°C/W @ 200 LFM
657-20ABEPN	2.000 (50.8)	1.650 (41.9) x 1.000 (25.4)	32°C @ 6W	2.9°C/W @ 200 LFM
657-25ABEPN	2.500 (63.5)	1.650 (41.9) x 1.000 (25.4)	25°C @ 6W	2.7°C/W @ 200 LFM

Wave-solderable pins. Material: Aluminum, Black Anodized

**MECHANICAL DIMENSIONS**

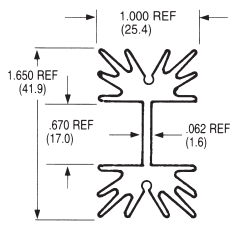

Dimensions: in. (mm)

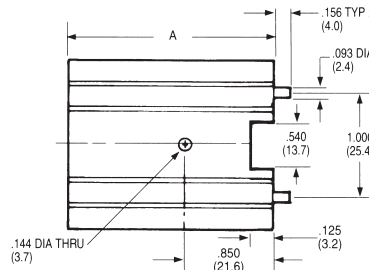

**657 SERIES**

657 SERIES (EXTRUSION PROFILE 6533)

**NATURAL AND FORCED CONVECTION CHARACTERISTICS**

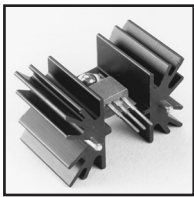
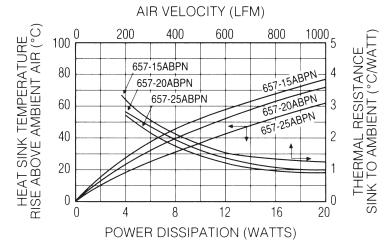

**657 SERIES High-Performance Heat Sinks with SpeedClips™ for Vertical Board Mounting**

TO-220, TO-247, TO-218

Standard P/N	Height Above PC Board "A" in. (mm)	Maximum Footprint in. (mm)	Thermal Performance at Typical Load Natural Convection	Thermal Performance at Typical Load Forced Convection
657-10ABEPSC	1.000 (25.4)	1.650 (41.9) x 1.000 (25.4)	41°C @ 6W	3.7°C/W @ 200 LFM
657-15ABEPSC	1.500 (38.1)	1.650 (41.9) x 1.000 (25.4)	38°C @ 6W	3.3°C/W @ 200 LFM
657-20ABEPSC	2.000 (50.8)	1.650 (41.9) x 1.000 (25.4)	32°C @ 6W	2.9°C/W @ 200 LFM
657-25ABEPSC	2.500 (63.5)	1.650 (41.9) x 1.000 (25.4)	25°C @ 6W	2.7°C/W @ 200 LFM

Wave-solderable pins. Material: Aluminum, Black Anodized

**MECHANICAL DIMENSIONS**

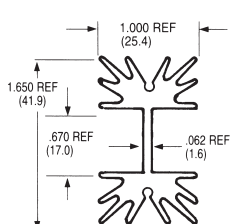

Dimensions: in. (mm)

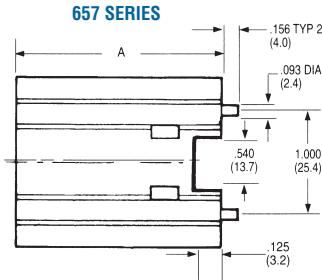

**657 SERIES**

657 SERIES (EXTRUSION PROFILE 6533)

**NATURAL AND FORCED CONVECTION CHARACTERISTICS**

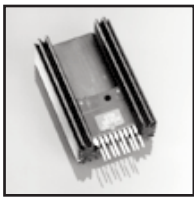
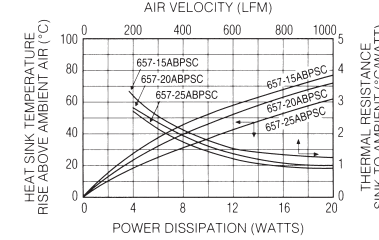

**677 SERIES High-Performance, High-Power Heat Sinks for Vertical Board Mounting**

TO-218, TO-220, TO-247 15-LEAD Multiwatt

Standard P/N	Height Above PC Board "A" in. (mm)	Maximum Footprint in. (mm)	Thermal Performance at Typical Load Natural Convection	Thermal Performance at Typical Load Forced Convection
677-10ABEP	1.000 (25.4)	1.650 (41.9) x 1.000 (25.4)	52°C @ 6W	3.1°C/W @ 200 LFM
677-15ABEP	1.500 (38.1)	1.650 (41.9) x 1.000 (25.4)	46°C @ 6W	2.8°C/W @ 200 LFM
677-20ABEP	2.000 (50.8)	1.650 (41.9) x 1.000 (25.4)	40°C @ 6W	2.5°C/W @ 200 LFM
677-25ABEP	2.500 (63.5)	1.650 (41.9) x 1.000 (25.4)	35°C @ 6W	2.2°C/W @ 200 LFM

Wave-solderable pins. Material: Aluminum, Black Anodized

**MECHANICAL DIMENSIONS**

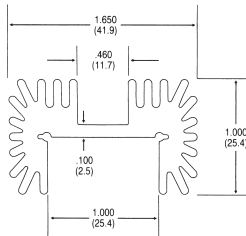

Dimensions: in. (mm)

**677 SERIES**

677 SERIES (EXTRUSION PROFILE 8719)

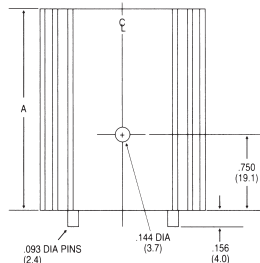

**NATURAL AND FORCED CONVECTION CHARACTERISTICS**

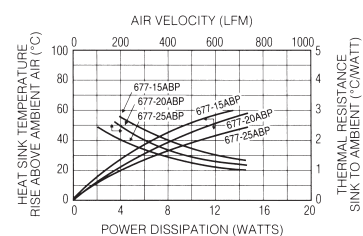

## BOARD LEVEL POWER SEMICONDUCTOR HEAT SINKS



### 690 SERIES

Highest Efficiency/Lowest Unit Cost Heat Sinks

TO-3, TO-66, TO-220

Standard P/N	Height Above PC Board in. (mm)	Outline Dimensions in. (mm)	Thermal Performance at Typical Load Natural Convection	Thermal Performance at Typical Load Forced Convection	Semiconductor Mounting Hole Pattern	Weight lbs. (grams)
690-3B	1.310 (33.3)	1.860 (47.2)-sq	44°C @ 7.5W	2.0°C/W @ 400 LFM	(1) TO-3	0.0700 (31.75)
690-66B	1.310 (33.3)	1.860 (47.2)-sq	44°C @ 7.5W	2.0°C/W @ 400 LFM	(1) TO-66	0.0700 (31.75)
690-220B	1.310 (33.3)	1.860 (47.2)-sq	44°C @ 7.5W	2.0°C/W @ 400 LFM	(2) TO-220	0.0700 (31.75)

Material: Aluminum, Black Anodized

These low-cost heat sinks provide the most power dissipation at the lowest unit cost and are available in three standard types to mount and cool one TO-3 or TO-66 metal power semiconductor type or two plastic package TO-220 power semiconductor types. For higher power

semiconductors, the 690 Series can dissipate up to 20 watts while maintaining a mounting surface temperature rise above ambient air temperature of no more than 91°C.

### MECHANICAL DIMENSIONS

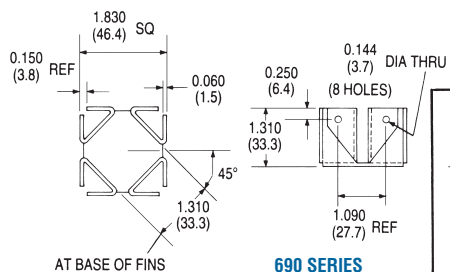

### SEMICONDUCTOR MOUNTING HOLES

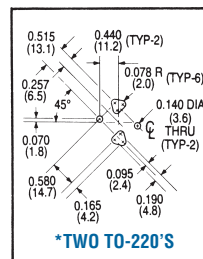
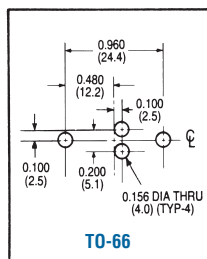
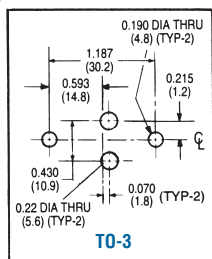

### NATURAL AND FORCED CONVECTION CHARACTERISTICS

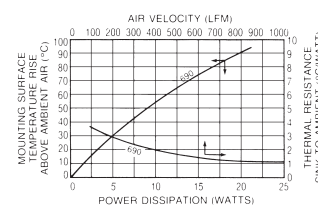

### 680 SERIES

Maximum Efficiency Omnidirectional Heat Sinks

TO-3, TO-220

Standard P/N	Height Above PC Board "A" in. (mm)	Horizontal Mounting Footprint Dimensions in. (mm)	Thermal Performance at Typical Load Natural Convection	Thermal Performance at Typical Load Forced Convection	Semiconductor Mounting Hole Pattern	Weight lbs. (grams)
680-5A	0.500 (12.7)	1.810 (46.0)-sq	70°C @ 7.5W	3.0°C/W @ 400 LFM	(1) TO-3	0.0700 (31.75)
680-75A	0.750 (19.1)	1.810 (46.0)-sq	58°C @ 7.5W	2.4°C/W @ 400 LFM	(1) TO-3	0.0900 (40.82)
680-10A	1.000 (25.4)	1.810 (46.0)-sq	52°C @ 7.5W	2.0°C/W @ 400 LFM	(1) TO-3	0.0980 (44.45)
680-125A	1.250 (31.8)	1.810 (46.0)-sq	45°C @ 7.5W	1.5°C/W @ 400 LFM	(1) TO-3	0.1100 (49.90)
680-5220	0.500 (12.7)	1.810 (46.0)-sq	70°C @ 7.5W	3.0°C/W @ 400 LFM	(2) TO-220	0.0700 (31.75)
680-75220	0.750 (19.1)	1.810 (46.0)-sq	58°C @ 7.5W	2.4°C/W @ 400 LFM	(2) TO-220	0.0900 (40.82)
680-10220	1.000 (25.4)	1.810 (46.0)-sq	52°C @ 7.5W	2.0°C/W @ 400 LFM	(2) TO-220	0.0980 (44.45)
680-125220	1.250 (31.8)	1.810 (46.0)-sq	45°C @ 7.5W	1.5°C/W @ 400 LFM	(2) TO-220	0.1100 (49.90)

Material: Aluminum, Black Anodized

Achieve optimum natural convection cooling per unit volume occupied above the printed circuit board for TO-3 (one semiconductor package per heat sink) or for two TO-220 style cases, when this low-cost heat sink is used. Any mounting attitude will provide free circulation of air in

natural convection applications. These 680 Series heat sinks can also be specified without any semiconductor mounting hole pattern by specifying suffix "K" (Example: 680-5K).

### MECHANICAL DIMENSIONS

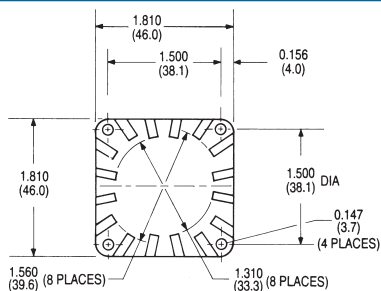

### 680 SERIES

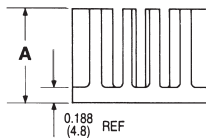

### NATURAL AND FORCED CONVECTION CHARACTERISTICS

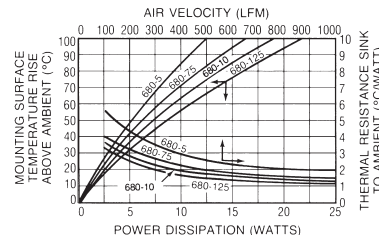

### SEMICONDUCTOR MOUNTING HOLES

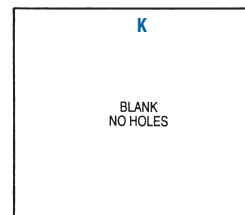
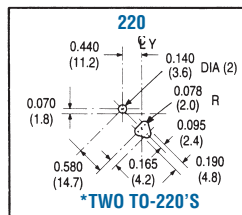
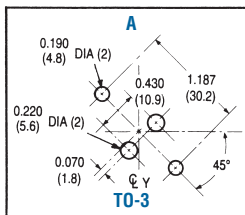

\*Only one hole pattern of two is shown. Hole patterns are symmetrical about the center lines.

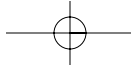

**Board Level Heat Sinks**

**BOARD LEVEL POWER SEMICONDUCTOR HEAT SINKS**

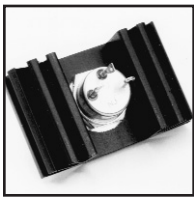

**601 & 603 SERIES Low-Height Heat Sinks**

DO-4/DO-5 Diodes

Standard P/N	Footprint Dimensions in. (mm)	Height in. (mm)	Mounting Hole Dia. in. (mm)	Thermal Performance at Typical Load		Weight lbs. (grams)
				Natural Convection	Forced Convection	
601E	2.000 (50.8) x 1.250 (31.8)	0.562 (14.3)	0.200 (5.1)	52°C @ 5.0W	4.5°C/W @ 175 LFM	0.0500 (22.68)
601F	2.000 (50.8) x 1.250 (31.8)	0.562 (14.3)	0.270 (6.9)	52°C @ 5.0W	4.5°C/W @ 175 LFM	0.0500 (22.68)
601K	2.000 (50.8) x 1.250 (31.8)	0.562 (14.3)	None	52°C @ 5.0W	4.5°C/W @ 175 LFM	0.0500 (22.68)
603K	2.000 (50.8) x 2.000 (50.8)	0.562 (14.3)	None	41°C @ 5.0W	4.0°C/W @ 175 LFM	0.0810 (36.74)

Material: Aluminum Alloy, Black Anodized

Use these low-height heat sinks on printed circuit board applications for TO-66 power semi-conductors and DO-4 and DO-5 diodes, where close board-to-board spacing and efficient heat

dissipation are required. The 601 and 603 Series may also be attached to enclosure panels or brackets using isolation hardware where necessary.

**MECHANICAL DIMENSIONS**

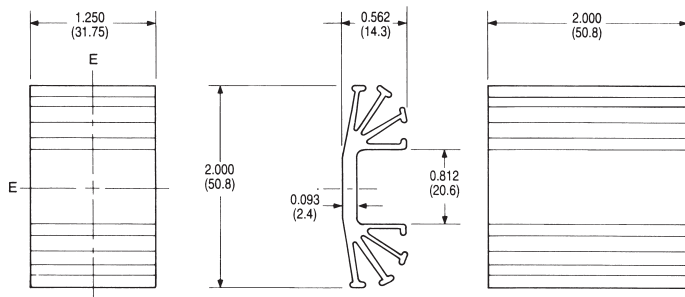

**601 SERIES (EXTRUSION PROFILE 1284)**

**603 SERIES (EXTRUSION PROFILE 1284)**

**NATURAL AND FORCED CONVECTION CHARACTERISTICS**

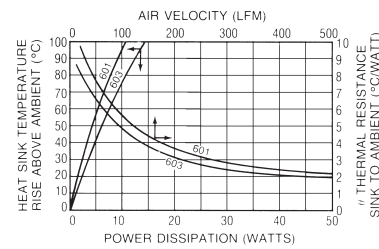

**SEMICONDUCTOR MOUNTING HOLES**

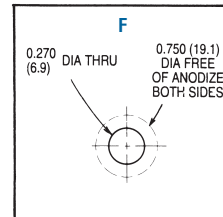
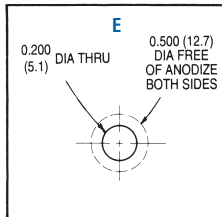
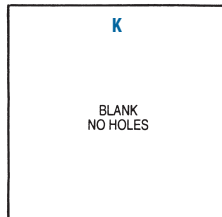

Dimensions: in. (mm)

E&F available on 601 Series only as a standard product.

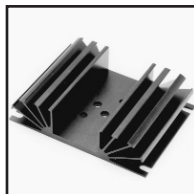

**641 SERIES Maximum Performance Natural Convection Heat Sink for all Metal-Case Semiconductors**

TO-3

Standard P/N	Outline Dimensions in. (mm)	Height in. (mm)	Mounting Hole Pattern	Thermal Performance at Typical Load		Weight lbs. (grams)
				Natural Convection	Forced Convection	
641A	4.125 (104.8) x 3.000 (76.2)	1.000 (25.4)	(1) TO-3	36°C @ 15W	0.9°C/W @ 250 LFM	0.2900 (131.54)
641K	4.125 (104.8) x 3.000 (76.2)	1.000 (25.4)	None	36°C @ 15W	0.9°C/W @ 250 LFM	0.2900 (131.54)

Available with a standard TO-3 mounting hole pattern predrilled for cost-effective mounting in limited-height applications, the 641 Series provides maximum performance in natural convection with an optimized heat sink surface area. The 641K type with an open channel area of

1.300 in. (33.0) and no predrilled mounting holes can be adapted to meet mounting requirements for most metal case power semiconductor types. Material: Aluminum Alloy, Black Anodized.

**MECHANICAL DIMENSIONS**

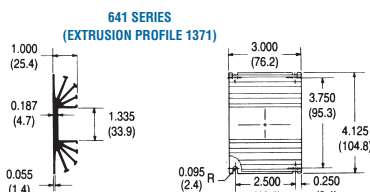

Dimensions: in. (mm)

**SEMICONDUCTOR MOUNTING HOLES**

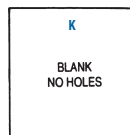
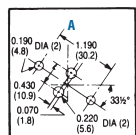

**NATURAL AND FORCED CONVECTION CHARACTERISTICS**

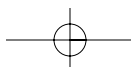
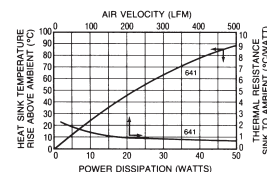



Компания «Life Electronics» занимается поставками электронных компонентов импортного и отечественного производства от производителей и со складов крупных дистрибьюторов Европы, Америки и Азии.

С конца 2013 года компания активно расширяет линейку поставок компонентов по направлению коаксиальный кабель, кварцевые генераторы и конденсаторы (керамические, пленочные, электролитические), за счёт заключения дистрибьюторских договоров

Мы предлагаем:

- Конкурентоспособные цены и скидки постоянным клиентам.
- Специальные условия для постоянных клиентов.
- Подбор аналогов.
- Поставку компонентов в любых объемах, удовлетворяющих вашим потребностям.
- Приемлемые сроки поставки, возможна ускоренная поставка.
- Доставку товара в любую точку России и стран СНГ.
- Комплексную поставку.
- Работу по проектам и поставку образцов.
- Формирование склада под заказчика.
- Сертификаты соответствия на поставляемую продукцию (по желанию клиента).
- Тестирование поставляемой продукции.
- Поставку компонентов, требующих военную и космическую приемку.
- Входной контроль качества.
- Наличие сертификата ISO.

В составе нашей компании организован Конструкторский отдел, призванный помогать разработчикам, и инженерам.

Конструкторский отдел помогает осуществить:

- Регистрацию проекта у производителя компонентов.
- Техническую поддержку проекта.
- Защиту от снятия компонента с производства.
- Оценку стоимости проекта по компонентам.
- Изготовление тестовой платы монтаж и пусконаладочные работы.



Тел: +7 (812) 336 43 04 (многоканальный)

Email: [org@lifeelectronics.ru](mailto:org@lifeelectronics.ru)

[www.lifeelectronics.ru](http://www.lifeelectronics.ru)