

The S-8211E Series has high-accuracy voltage detections circuit and delay circuits.

The S-8211E Series is suitable for monitoring overcharge and overdischarge of 1-cell lithium ion / lithium polymer rechargeable battery pack.

## ■ Features

- |   |  |  |
|---|--|--|
| (1) High-accuracy voltage detection circuit   |  |  |
| • Overcharge detection voltage  | 3.6 V to 4.5 V (5 mV step)                 | Accuracy $\pm 25$ mV (+25°C)<br>Accuracy $\pm 30$ mV (-5°C to +55°C) |
| • Overcharge release voltage  | 3.5 V to 4.4 V <sup>*1</sup>               | Accuracy $\pm 50$ mV   |
| • Overdischarge detection voltage   | 2.0 V to 3.0 V (10 mV step)                | Accuracy $\pm 50$ mV   |
| • Overdischarge release voltage   | 2.0 V to 3.4 V <sup>*2</sup>               | Accuracy $\pm 100$ mV  |
| (2) Detection delay times are generated by an internal circuit<br>(external capacitors are unnecessary) |  | Accuracy $\pm 20\%$  |
| (3) Wide operating temperature range  | -40°C to +85°C                             |  |
| (4) Low current consumption   |  |  |
| • During operation  | 3.0 $\mu$ A typ., 5.5 $\mu$ A max. (+25°C) |  |
| • During overdischarge  | 2.0 $\mu$ A typ., 3.5 $\mu$ A max. (+25°C) |  |
| (5) Output logic of CO pin is selectable.   | Active "H", Active "L"                     |  |
| (6) Lead-free, Sn 100%, halogen-free <sup>*3</sup>  |  |  |

\*1. Overcharge release voltage = Overcharge detection voltage – Overcharge hysteresis voltage  
(Overcharge hysteresis voltage can be selected as 0 V or from a range of 0.1 V to 0.4 V in 50 mV step.)

\*2. Overdischarge release voltage = Overdischarge detection voltage + Overdischarge hysteresis voltage  
(Overdischarge hysteresis voltage can be selected as 0 V or from a range of 0.1 V to 0.7 V in 100 mV step.)

\*3. Refer to "■ Product Name Structure" for details.

## ■ Applications

- Lithium-ion rechargeable battery pack
- Lithium-polymer rechargeable battery pack

## ■ Packages

- SOT-23-5
- SNT-6A

■ **Block Diagram**



**Remark** All diodes shown in figure are parasitic diodes.

**Figure 1**

■ **Product Name Structure**

**1. Product Name**



\*1. Refer to the tape drawing.

\*2. Refer to “3. Product Name List”.

**2. Packages**

Package Name	Drawing Code			
	Package	Tape	Reel	Land
SOT-23-5	MP005-A-P-SD	MP005-A-C-SD	MP005-A-R-SD	-
SNT-6A	PG006-A-P-SD	PG006-A-C-SD	PG006-A-R-SD	PG006-A-L-SD

**3. Product Name List**

**3.1 SOT-23-5**

**Table 1**

Product Name	Overcharge Detection Voltage [V <sub>CU</sub> ]	Overcharge Release Voltage [V <sub>CL</sub> ]	Overdischarge Detection Voltage [V <sub>DL</sub> ]	Overdischarge Release Voltage [V <sub>DU</sub> ]	Delay Time Combination* <sup>1</sup>	CO Pin Output Form
S-8211EAC-M5T1U	3.600 V	3.600 V	2.00 V	2.00 V	(1)	CMOS output active "L"
S-8211EAF-M5T1U	3.650 V	3.550 V	2.00 V	2.30 V	(2)	CMOS output active "L"
S-8211EAG-M5T1U	3.800 V	3.600 V	2.00 V	2.30 V	(2)	CMOS output active "L"
S-8211EAJ-M5T1U	4.180 V	4.180 V	2.50 V	3.00 V	(1)	CMOS output active "H"
S-8211EAK-M5T1U	3.600 V	3.600 V	2.00 V	2.30 V	(1)	CMOS output active "H"

\*1. Refer to the **Table 3** about the details of the delay time combinations (1), (2).

**Remark** Please contact our sales office for the products with detection voltage value other than those specified above.

**3.2 SNT-6A**

**Table 2**

Product Name	Overcharge Detection Voltage [V <sub>CU</sub> ]	Overcharge Release Voltage [V <sub>CL</sub> ]	Overdischarge Detection Voltage [V <sub>DL</sub> ]	Overdischarge Release Voltage [V <sub>DU</sub> ]	Delay Time Combination* <sup>1</sup>	CO Pin Output Form
S-8211EAA-I6T1U	4.220 V	4.220 V	2.00 V	2.00 V	(2)	CMOS output active "L"
S-8211EAB-I6T1U	4.270 V	4.270 V	2.00 V	2.00 V	(2)	CMOS output active "L"
S-8211EAD-I6T1U	4.220 V	4.220 V	2.50 V	2.50 V	(2)	CMOS output active "L"
S-8211EAE-I6T1U	4.220 V	4.220 V	2.30 V	2.30 V	(2)	CMOS output active "L"
S-8211EAH-I6T1U	4.000 V	3.800 V	3.00 V	3.20 V	(1)	CMOS output active "L"
S-8211EAI-I6T1U	3.800 V	3.700 V	2.30 V	2.40 V	(1)	CMOS output active "L"
S-8211EAP-I6T1U	4.280 V	4.080 V	2.50 V	2.50 V	(1)	CMOS output active "L"

\*1. Refer to the **Table 3** about the details of the delay time combinations (1), (2).

**Remark** Please contact our sales office for the products with detection voltage value other than those specified above.

**Table 3**

Delay Time Combination	Overcharge Detection Delay Time [t <sub>CU</sub> ]	Overdischarge Detection Delay Time [t <sub>DL</sub> ]
(1)	1.2 s	150 ms
(2)	573 ms	300 ms

**Remark** The delay times can be changed within the range listed **Table 4**. For details, please contact our sales office.

**Table 4**

Delay Time	Symbol	Selection Range			Remark
Overcharge detection delay time	t <sub>CU</sub>	143 ms	573 ms	1.2 s	Select a value from the left.
Overdischarge detection delay time	t <sub>DL</sub>	38 ms	150 ms	300 ms	Select a value from the left.

**Remark** The value surrounded by bold lines is the delay time of the standard products.

### ■ Pin Configurations

#### 1. SOT-23-5



Figure 2

Table 5

Pin No.	Symbol	Description
1	VM	Negative power supply input pin for CO pin
2	VDD	Input pin for positive power supply
3	VSS	Input pin for negative power supply
4	DO	Output pin for overdischarge detection (CMOS output)
5	CO	Output pin for overcharge detection (CMOS output)

#### 2. SNT-6A



Figure 3

Table 6

Pin No.	Symbol	Description
1	NC <sup>*1</sup>	No connection
2	CO	Output pin for overcharge detection (CMOS output)
3	DO	Output pin for overdischarge detection (CMOS output)
4	VSS	Input pin for negative power supply
5	VDD	Input pin for positive power supply
6	VM	Negative power supply input pin for CO pin

\*1. The NC pin is electrically open.

The NC pin can be connected to VDD pin or VSS pin.

■ **Absolute Maximum Ratings**

**Table 7**

(Ta = +25°C unless otherwise specified)

Item	Symbol	Applied pin	Absolute Maximum Ratings	Unit
Input voltage between VDD pin and VSS pin	$V_{DS}$	VDD	$V_{SS} - 0.3$ to $V_{SS} + 12$	V
VM pin input voltage	$V_{VM}$	VM	$V_{DD} - 28$ to $V_{DD} + 0.3$	V
DO pin output voltage	$V_{DO}$	DO	$V_{SS} - 0.3$ to $V_{DD} + 0.3$	V
CO pin output voltage	$V_{CO}$	CO	$V_{VM} - 0.3$ to $V_{DD} + 0.3$	V
Power dissipation	SOT-23-5	—	600 <sup>*1</sup>	mW
	SNT-6A	—	400 <sup>*1</sup>	mW
Operating ambient temperature	$T_{opr}$	—	-40 to +85	°C
Storage temperature	$T_{stg}$	—	-55 to +125	°C

\*1. When mounted on board  
 [Mounted board]

- (1) Board size: 114.3 mm × 76.2 mm × t1.6 mm
- (2) Board name: JEDEC STANDARD51-7

**Caution** The absolute maximum ratings are rated values exceeding which the product could suffer physical damage. These values must therefore not be exceeded under any conditions.



**Figure 4 Power Dissipation of Package (When Mounted on Board)**

### ■ Electrical Characteristics

#### 1. Except Detection Delay Time (+25°C)

Table 8

(Ta = +25°C unless otherwise specified)

Item	Symbol	Condition	Min.	Typ.	Max.	Unit	Test Condition	Test Circuit	
<b>DETECTION VOLTAGE</b>									
Overcharge detection voltage	V <sub>CU</sub>	3.60 V to 4.50 V, Adjustable	V <sub>CU</sub> -0.025	V <sub>CU</sub>	V <sub>CU</sub> +0.025	V	1	1	
		3.60 V to 4.50 V, Adjustable, Ta = -5°C to +55°C*1	V <sub>CU</sub> -0.03	V <sub>CU</sub>	V <sub>CU</sub> +0.03	V	1	1	
Overcharge release voltage	V <sub>CL</sub>	3.50 V to 4.40 V, Adjustable	V <sub>CL</sub> ≠ V <sub>CU</sub>	V <sub>CL</sub> -0.05	V <sub>CL</sub>	V <sub>CL</sub> +0.05	V	1	1
			V <sub>CL</sub> = V <sub>CU</sub>	V <sub>CL</sub> -0.05	V <sub>CL</sub>	V <sub>CL</sub> +0.025	V	1	1
Overdischarge detection voltage	V <sub>DL</sub>	2.00 V to 3.00 V, Adjustable	V <sub>DL</sub> -0.05	V <sub>DL</sub>	V <sub>DL</sub> +0.05	V	2	2	
Overdischarge release voltage	V <sub>DU</sub>	2.00 V to 3.40 V, Adjustable	V <sub>DU</sub> ≠ V <sub>DL</sub>	V <sub>DU</sub> -0.10	V <sub>DU</sub>	V <sub>DU</sub> +0.10	V	2	2
			V <sub>DU</sub> = V <sub>DL</sub>	V <sub>DU</sub> -0.05	V <sub>DU</sub>	V <sub>DU</sub> +0.05	V	2	2
<b>INPUT VOLTAGE</b>									
Operating voltage between VDD pin and VSS pin	V <sub>DSOP1</sub>	–	1.5	–	8	V	–	–	
<b>INPUT CURRENT</b>									
Current consumption during operation	I <sub>OPE</sub>	V <sub>DD</sub> = 3.5 V, V <sub>VM</sub> = 0 V	1.0	3.0	5.5	μA	3	2	
Current consumption during overdischarge	I <sub>OPED</sub>	V <sub>DD</sub> = 1.5 V, V <sub>VM</sub> = 0 V	0.3	2.0	3.5	μA	3	2	
<b>OUTPUT RESISTANCE</b>									
CO pin resistance "H"	R <sub>COH</sub>	–	2.5	5	10	kΩ	4	3	
CO pin resistance "L"	R <sub>COL</sub>	CO pin output logic active "H"	2.5	9	15	kΩ	4	3	
		CO pin output logic active "L"	2.5	5	10	kΩ	4	3	
DO pin resistance "H"	R <sub>DOH</sub>	–	2.5	5	10	kΩ	5	3	
DO pin resistance "L"	R <sub>DOL</sub>	–	2.5	5	10	kΩ	5	3	

\*1. Since products are not screened at high and low temperature, the specification for this temperature range is guaranteed by design, not tested in production.

**2. Except Detection Delay Time (−40°C to +85°C \*1)**

**Table 9**

(Ta = −40°C to +85°C \*1 unless otherwise specified)

Item	Symbol	Condition	Min.	Typ.	Max.	Unit	Test Condition	Test Circuit
<b>DETECTION VOLTAGE</b>								
Overcharge detection voltage	V <sub>CU</sub>	3.60 V to 4.50 V, Adjustable	V <sub>CU</sub> − 0.060	V <sub>CU</sub>	V <sub>CU</sub> + 0.040	V	1	1
Overcharge release voltage	V <sub>CL</sub>	3.50 V to 4.40 V, Adjustable	V <sub>CL</sub> ≠ V <sub>CU</sub>	V <sub>CL</sub> − 0.08	V <sub>CL</sub> + 0.065	V	1	1
			V <sub>CL</sub> = V <sub>CU</sub>	V <sub>CL</sub> − 0.08	V <sub>CL</sub> + 0.04	V	1	1
Overdischarge detection voltage	V <sub>DL</sub>	2.00 V to 3.00 V, Adjustable	V <sub>DL</sub> − 0.11	V <sub>DL</sub>	V <sub>DL</sub> + 0.13	V	2	2
Overdischarge release voltage	V <sub>DU</sub>	2.00 V to 3.40 V, Adjustable	V <sub>DU</sub> ≠ V <sub>DL</sub>	V <sub>DU</sub> − 0.15	V <sub>DU</sub> + 0.19	V	2	2
			V <sub>DU</sub> = V <sub>DL</sub>	V <sub>DU</sub> − 0.11	V <sub>DU</sub> + 0.13	V	2	2
<b>INPUT VOLTAGE</b>								
Operating voltage between VDD pin and VSS pin	V <sub>DSOP1</sub>	−	1.5	−	8	V	−	−
<b>INPUT CURRENT</b>								
Current consumption during operation	I <sub>OPe</sub>	V <sub>DD</sub> = 3.5 V, V <sub>VM</sub> = 0 V	0.7	3.0	6.0	μA	3	2
Current consumption during overdischarge	I <sub>OPeD</sub>	V <sub>DD</sub> = 1.5 V, V <sub>VM</sub> = 0 V	0.2	2.0	3.8	μA	3	2
<b>OUTPUT RESISTANCE</b>								
CO pin resistance "H"	R <sub>COH</sub>	−	1.2	5	15	kΩ	4	3
CO pin resistance "L"	R <sub>COL</sub>	CO pin output logic active "H"	1.2	9	27	kΩ	4	3
		CO pin output logic active "L"	1.2	5	15	kΩ	4	3
DO pin resistance "H"	R <sub>DOH</sub>	−	1.2	5	15	kΩ	5	3
DO pin resistance "L"	R <sub>DOL</sub>	−	1.2	5	15	kΩ	5	3

\*1. Since products are not screened at high and low temperature, the specification for this temperature range is guaranteed by design, not tested in production.



### 3. Detection Delay Time

#### 3.1 S-8211EAC, S-8211EAH, S-8211EAI, S-8211EAJ, S-8211EAK, S-8211EAP

**Table 10**

Item	Symbol	Condition	Min.	Typ.	Max.	Unit	Test Condition	Test Circuit
<b>DELAY TIME (Ta = +25°C)</b>								
Overcharge detection delay time	t <sub>CU</sub>	–	0.96	1.2	1.4	s	6	4
Overdischarge detection delay time	t <sub>DL</sub>	–	120	150	180	ms	6	4
<b>DELAY TIME (Ta = –40°C to +85°C) *1</b>								
Overcharge detection delay time	t <sub>CU</sub>	–	0.7	1.2	2.0	s	6	4
Overdischarge detection delay time	t <sub>DL</sub>	–	83	150	255	ms	6	4

\*1. Since products are not screened at high and low temperature, the specification for this temperature range is guaranteed by design, not tested in production.

#### 3.2 S-8211EAA, S-8211EAB, S-8211EAD, S-8211EAE, S-8211EAF, S-8211EAG

**Table 11**

Item	Symbol	Condition	Min.	Typ.	Max.	Unit	Test Condition	Test Circuit
<b>DELAY TIME (Ta = +25°C)</b>								
Overcharge detection delay time	t <sub>CU</sub>	–	458	573	687	ms	6	4
Overdischarge detection delay time	t <sub>DL</sub>	–	240	300	360	ms	6	4
<b>DELAY TIME (Ta = –40°C to +85°C) *1</b>								
Overcharge detection delay time	t <sub>CU</sub>	–	334	573	955	ms	6	4
Overdischarge detection delay time	t <sub>DL</sub>	–	166	300	510	ms	6	4

\*1. Since products are not screened at high and low temperature, the specification for this temperature range is guaranteed by design, not tested in production.

## ■ Test Circuits

**Caution** Unless otherwise specified, the output voltage levels “H” and “L” at CO pin ( $V_{CO}$ ) are judged by  $V_{VM} + 1.0$  V, and the output voltage levels “H” and “L” at DO pin ( $V_{DO}$ ) are judged by  $V_{SS} + 1.0$  V. Judge the CO pin level with respect to  $V_{VM}$  and the DO pin level with respect to  $V_{SS}$ .

### 1. Overcharge Detection Voltage, Overcharge Release Voltage (Test Condition 1, Test Circuit 1)

#### 1. 1 CO pin output logic = Active “H”

Overcharge detection voltage ( $V_{CU}$ ) is defined as the voltage between the VDD pin and VSS pin at which  $V_{CO}$  goes from “L” to “H” when the voltage  $V_1$  is gradually increased from the starting condition of  $V_1 = 3.5$  V. Overcharge release voltage ( $V_{CL}$ ) is defined as the voltage between the VDD pin and VSS pin at which  $V_{CO}$  goes from “H” to “L” when the voltage  $V_1$  is then gradually decreased. Overcharge hysteresis voltage ( $V_{HC}$ ) is defined as the difference between overcharge detection voltage ( $V_{CU}$ ) and overcharge release voltage ( $V_{CL}$ ).

#### 1. 2 CO pin output logic = Active “L”

Overcharge detection voltage ( $V_{CU}$ ) is defined as the voltage between the VDD pin and VSS pin at which  $V_{CO}$  goes from “H” to “L” when the voltage  $V_1$  is gradually increased from the starting condition of  $V_1 = 3.5$  V. Overcharge release voltage ( $V_{CL}$ ) is defined as the voltage between the VDD pin and VSS pin at which  $V_{CO}$  goes from “L” to “H” when the voltage  $V_1$  is then gradually decreased. Overcharge hysteresis voltage ( $V_{HC}$ ) is defined as the difference between overcharge detection voltage ( $V_{CU}$ ) and overcharge release voltage ( $V_{CL}$ ).

### 2. Overdischarge Detection Voltage, Overdischarge Release Voltage (Test Condition 2, Test Circuit 2)

Overdischarge detection voltage ( $V_{DL}$ ) is defined as the voltage between the VDD pin and VSS pin at which  $V_{DO}$  goes from “H” to “L” when the voltage  $V_1$  is gradually decreased from the starting condition of  $V_1 = 3.5$  V,  $V_2 = 0$  V. Overdischarge release voltage ( $V_{DU}$ ) is defined as the voltage between the VDD pin and VSS pin at which  $V_{DO}$  goes from “L” to “H” when the voltage  $V_1$  is then gradually increased. Overdischarge hysteresis voltage ( $V_{HD}$ ) is defined as the difference between overdischarge release voltage ( $V_{DU}$ ) and overdischarge detection voltage ( $V_{DL}$ ).

### 3. Current Consumption during Operation (Test Condition 3, Test Circuit 2)

The current consumption during operation ( $I_{OPE}$ ) is the current that flows through the VDD pin ( $I_{DD}$ ) under the set conditions of  $V_1 = 3.5$  V and  $V_2 = 0$  V (normal status).

### 4. Current Consumption during Overdischarge (Test Condition 3, Test Circuit 2)

The current consumption during overdischarge ( $I_{OPED}$ ) is the current that flows through the VDD pin ( $I_{DD}$ ) under the set conditions of  $V_1 = 1.5$  V,  $V_2 = 0$  V (overdischarge status).

## **5. CO Pin Resistance “H”**

### **(Test Condition 4, Test Circuit 3)**

#### **5.1 CO pin output logic = Active “H”**

The CO pin resistance “H” ( $R_{COH}$ ) is the resistance at the CO pin under the set conditions of  $V1 = 4.5\text{ V}$ ,  $V2 = 0\text{ V}$ ,  $V3 = 4.0\text{ V}$ .

#### **5.2 CO pin output logic = Active “L”**

The CO pin resistance “H” ( $R_{COH}$ ) is the resistance at the CO pin under the set conditions of  $V1 = 3.5\text{ V}$ ,  $V2 = 0\text{ V}$ ,  $V3 = 3.0\text{ V}$ .

## **6. CO Pin Resistance “L”**

### **(Test Condition 4, Test Circuit 3)**

#### **6.1 CO pin output logic = Active “H”**

The CO pin resistance “L” ( $R_{COL}$ ) is the resistance at the CO pin under the set conditions of  $V1 = 3.5\text{ V}$ ,  $V2 = 0\text{ V}$ ,  $V3 = 0.5\text{ V}$ .

#### **6.2 CO pin output logic = Active “L”**

The CO pin resistance “L” ( $R_{COL}$ ) is the resistance at the CO pin under the set conditions of  $V1 = 4.5\text{ V}$ ,  $V2 = 0\text{ V}$ ,  $V3 = 0.5\text{ V}$ .

## **7. DO Pin Resistance “H”**

### **(Test Condition 5, Test Circuit 3)**

The DO pin “H” resistance ( $R_{DOH}$ ) is the resistance at the DO pin under the set conditions of  $V1 = 3.5\text{ V}$ ,  $V2 = 0\text{ V}$ ,  $V4 = 3.0\text{ V}$ .

## **8. DO Pin Resistance “L”**

### **(Test Condition 5, Test Circuit 3)**

The DO pin “L” resistance ( $R_{DOL}$ ) is the resistance at the DO pin under the set conditions of  $V1 = 1.8\text{ V}$ ,  $V2 = 0\text{ V}$ ,  $V4 = 0.5\text{ V}$ .

## **9. Overcharge Detection Delay Time**

### **(Test Condition 6, Test Circuit 4)**

#### **9.1 CO pin output logic = Active “H”**

The overcharge detection delay time ( $t_{CU}$ ) is the time needed for  $V_{CO}$  to change from “L” to “H” just after the voltage  $V1$  momentarily increases (within  $10\text{ }\mu\text{s}$ ) from overcharge detection voltage ( $V_{CU}$ )  $-0.2\text{ V}$  to overcharge detection voltage ( $V_{CU}$ )  $+0.2\text{ V}$  under the set conditions of  $V2 = 0\text{ V}$ .

#### **9.2 CO pin output logic = Active “L”**

The overcharge detection delay time ( $t_{CU}$ ) is the time needed for  $V_{CO}$  to change from “H” to “L” just after the voltage  $V1$  momentarily increases (within  $10\text{ }\mu\text{s}$ ) from overcharge detection voltage ( $V_{CU}$ )  $-0.2\text{ V}$  to overcharge detection voltage ( $V_{CU}$ )  $+0.2\text{ V}$  under the set conditions of  $V2 = 0\text{ V}$ .

## **10. Overdischarge Detection Delay Time**

### **(Test Condition 6, Test Circuit 4)**

The overdischarge detection delay time ( $t_{DL}$ ) is the time needed for  $V_{DO}$  to change from “H” to “L” just after the voltage  $V1$  momentarily decreases (within  $10\text{ }\mu\text{s}$ ) from overdischarge detection voltage ( $V_{DL}$ )  $+0.2\text{ V}$  to overdischarge detection voltage ( $V_{DL}$ )  $-0.2\text{ V}$  under the set condition of  $V2 = 0\text{ V}$ .



**Figure 5 Test Circuit 1**



**Figure 6 Test Circuit 2**



**Figure 7 Test Circuit 3**



**Figure 8 Test Circuit 4**

## ■ Operation

**Remark** Refer to the “■ Battery Protection IC Connection Example”.

### 1. Normal Status

The S-8211E Series monitors the voltage of the battery connected between the VDD and VSS pins. In case of overdischarge detection voltage ( $V_{DL}$ )  $\leq$  battery voltage  $\leq$  overcharge detection voltage ( $V_{CU}$ ), the output levels of CO and DO pins are as follows. This is the normal status.

**Table 12**

CO Pin Output Logic	CO Pin	DO Pin
Active “H”	$V_{VM}$	$V_{DD}$
Active “L”	$V_{DD}$	$V_{DD}$

### 2. Overcharge Status

When the battery voltage in the normal status exceeds the overcharge detection voltage ( $V_{CU}$ ) during charge, and this status is held for the overcharge detection delay time ( $t_{CU}$ ) or more, the output levels of CO and DO pins are as follows. This is the overcharge status.

This overcharge status is released when the battery voltage decreases to the overcharge release voltage ( $V_{CL}$ ) or less.

**Table 13**

CO Pin Output Logic	CO Pin	DO Pin
Active “H”	$V_{DD}$	$V_{DD}$
Active “L”	$V_{VM}$	$V_{DD}$

### 3. Overdischarge Status

When the battery voltage in the normal status decreases than the overcharge detection voltage ( $V_{DL}$ ) during discharge, and this status is held for the overdischarge detection delay time ( $t_{DL}$ ) or more, the output levels of CO and DO pins are as follows. This is the overdischarge status.

This overdischarge status is released when the battery voltage increases to the overdischarge release voltage ( $V_{DU}$ ) or more.

**Table 14**

CO Pin Output Logic	CO Pin	DO Pin
Active “H”	$V_{VM}$	$V_{SS}$
Active “L”	$V_{DD}$	$V_{SS}$

### 4. Delay Circuit

The detection delay times are determined by dividing a clock of approximately 3.5 kHz by the counter.

■ **Timing Chart**

**1. Overcharge Detection, Overdischarge Detection**



- \*1. (1) : Normal status  
 (2) : Overcharge status  
 (3) : Overdischarge status

**Figure 9**

■ Battery Protection IC Connection Example

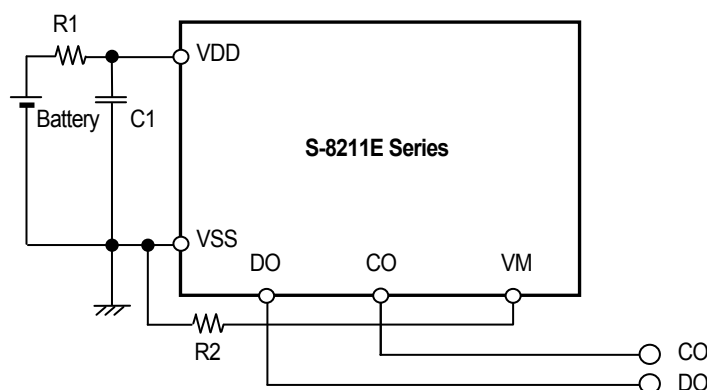

Figure 10

Table 15 Constants for External Components

Symbol	Part	Purpose	Min.	Typ.	Max.	Remark
R1	Resistor	ESD protection, For power fluctuation	100 Ω	220 Ω	330 Ω	Resistance should be as small as possible to avoid lowering the overcharge detection accuracy due to current consumption. *1
C1	Capacitor	For power fluctuation	0.022 μF	0.1 μF	1.0 μF	Connect a capacitor of 0.022 μF or higher between VDD pin and VSS pin. *2
R2 <sup>*3</sup>	Resistor	ESD protection	300 Ω	1 kΩ	4 kΩ	-

\*1. Insert a resistor of 100 Ω or higher as R1 for ESD protection.

\*2. If a capacitor of less than 0.022 μF is connected to C1, DO pin may oscillate. Be sure to connect a capacitor of 0.022 μF or higher to C1.

\*3. Be sure to using R2, connect the VM pin with the VSS pin.

**Caution** 1. The above constants may be changed without notice.

2. It has not been confirmed whether the operation is normal or not in circuits other than the above example of connection. In addition, the example of connection shown above and the constant do not guarantee proper operation. Perform thorough evaluation using the actual application to set the constant.

■ **Application Circuit Examples**

1. **Protection circuits series multi-cells**



Figure 11



**2. Charge cell-balance detection circuit**



**Figure 12**

■ **Precautions**

- The application conditions for the input voltage, output voltage, and load current should not exceed the package power dissipation.
- Be sure to using R2, connect the VM pin with the VSS pin.
- Do not apply an electrostatic discharge to this IC that exceeds the performance ratings of the built-in electrostatic protection circuit.
- ABLIC Inc. claims no responsibility for any and all disputes arising out of or in connection with any infringement by products including this IC of patents owned by a third party.

■ Characteristics (Typical Data)

1. Current Consumption

1.1  $I_{OPE}$  vs.  $T_a$



1.2  $I_{OPED}$  vs.  $T_a$

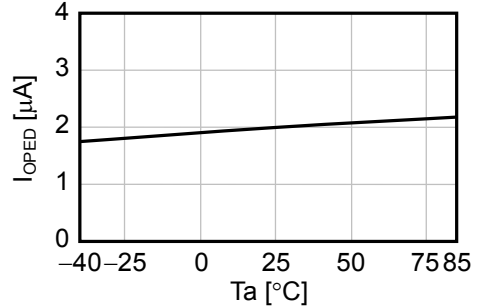

1.3  $I_{OPE}$  vs.  $V_{DD}$



2. Overcharge Detection / Release Voltage, Overdischarge Detection / Release Voltage, Overcurrent Detection Voltage, and Delay Time

2.1  $V_{CU}$  vs.  $T_a$

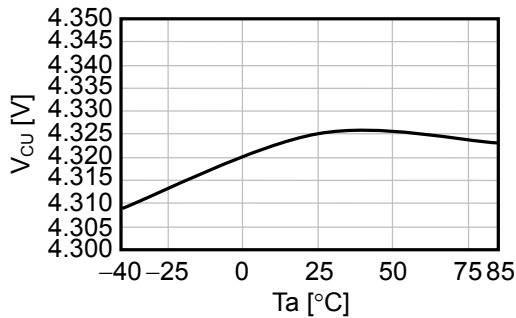

2.2  $V_{CL}$  vs.  $T_a$

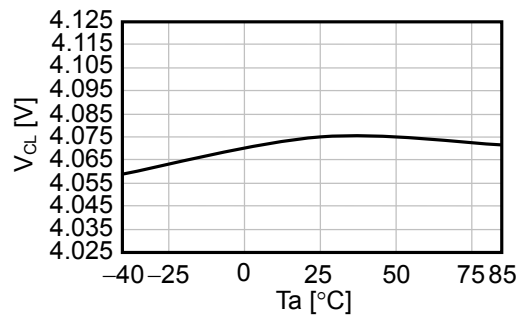

2.3  $V_{DU}$  vs.  $T_a$



2.4  $V_{DL}$  vs.  $T_a$

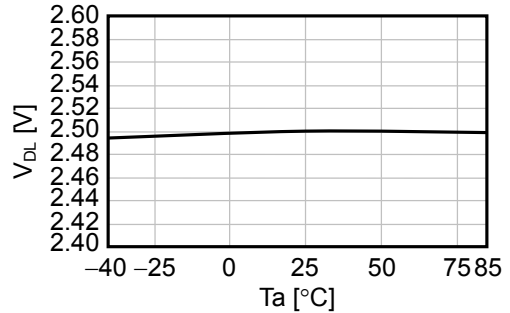

**2.5  $t_{CU}$  vs.  $T_a$**



**2.6  $t_{DL}$  vs.  $T_a$**



**3. CO pin / DO pin**

**3.1  $I_{COH}$  vs.  $V_{CO}$**



**3.2  $I_{COL}$  vs.  $V_{CO}$**



**3.3  $I_{DOH}$  vs.  $V_{DO}$**



**3.4  $I_{DOL}$  vs.  $V_{DO}$**



■ **Marking Specifications**

**1. SOT-23-5**



(1) to (3): Product Code (refer to **Product Name vs. Product Code**)  
(4) : Lot number

**Product Name vs. Product Code**

Product Name	Product Code		
	(1)	(2)	(3)
S-8211EAC-M5T1U	R	3	C
S-8211EAF-M5T1U	R	3	F
S-8211EAG-M5T1U	R	3	G
S-8211EAJ-M5T1U	R	3	J
S-8211EAK-M5T1U	R	3	K

**2. SNT-6A**



(1) to (3): Product Code (refer to **Product Name vs. Product Code**)  
(4) to (6): Lot number

**Product Name vs. Product Code**

Product Name	Product Code		
	(1)	(2)	(3)
S-8211EAA-I6T1U	R	3	A
S-8211EAB-I6T1U	R	3	B
S-8211EAD-I6T1U	R	3	D
S-8211EAE-I6T1U	R	3	E
S-8211EAH-I6T1U	R	3	H
S-8211EAI-I6T1U	R	3	I
S-8211EAP-I6T1U	R	3	P



No. MP005-A-P-SD-1.3

TITLE	SOT235-A-PKG Dimensions
No.	MP005-A-P-SD-1.3
ANGLE	
UNIT	mm
<b>ABLIC Inc.</b>	



Feed direction →

No. MP005-A-C-SD-2.1

TITLE	SOT235-A-Carrier Tape
No.	MP005-A-C-SD-2.1
ANGLE	
UNIT	mm
<b>ABLIC Inc.</b>	



Enlarged drawing in the central part



No. MP005-A-R-SD-1.1

TITLE	SOT235-A-Reel		
No.	MP005-A-R-SD-1.1		
ANGLE		QTY.	3,000
UNIT	mm		
<b>ABLIC Inc.</b>			



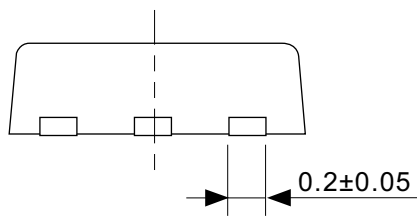
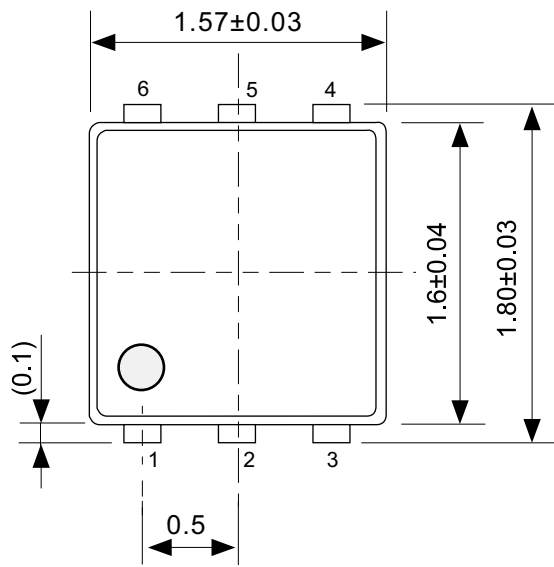

No. PG006-A-P-SD-2.1

TITLE	SNT-6A-A-PKG Dimensions
No.	PG006-A-P-SD-2.1
ANGLE	
UNIT	mm
<b>ABLIC Inc.</b>	



No. PG006-A-C-SD-2.0

TITLE	SNT-6A-A-Carrier Tape
No.	PG006-A-C-SD-2.0
ANGLE	
UNIT	mm
<b>ABLIC Inc.</b>	



Enlarged drawing in the central part



No. PG006-A-R-SD-1.0

TITLE	SNT-6A-A-Reel		
No.	PG006-A-R-SD-1.0		
ANGLE		QTY.	5,000
UNIT	mm		
<b>ABLIC Inc.</b>			



※1. ランドパターンの幅に注意してください (0.25 mm min. / 0.30 mm typ.).  
 ※2. パッケージ中央にランドパターンを広げないでください (1.30 mm ~ 1.40 mm)。

- 注意
1. パッケージのモールド樹脂下にシルク印刷やハンダ印刷などしないでください。
  2. パッケージ下の配線上のソルダーレジストなどの厚みをランドパターン表面から0.03 mm 以下にしてください。
  3. マスク開口サイズと開口位置はランドパターンと合わせてください。
  4. 詳細は "SNTパッケージ活用の手引き" を参照してください。

※1. Pay attention to the land pattern width (0.25 mm min. / 0.30 mm typ.).  
 ※2. Do not widen the land pattern to the center of the package ( 1.30 mm ~ 1.40 mm ).

- Caution**
1. Do not do silkscreen printing and solder printing under the mold resin of the package.
  2. The thickness of the solder resist on the wire pattern under the package should be 0.03 mm or less from the land pattern surface.
  3. Match the mask aperture size and aperture position with the land pattern.
  4. Refer to "SNT Package User's Guide" for details.

※1. 请注意焊盘模式的宽度 (0.25 mm min. / 0.30 mm typ.).  
 ※2. 请勿向封装中间扩展焊盘模式 (1.30 mm ~ 1.40 mm)。

- 注意
1. 请勿在树脂型封装的下面印刷丝网、焊锡。
  2. 在封装下、布线上的阻焊膜厚度 (从焊盘模式表面起) 请控制在 0.03 mm 以下。
  3. 钢网的开口尺寸和开口位置请与焊盘模式对齐。
  4. 详细内容请参阅 "SNT 封装的应用指南"。

No. PG006-A-L-SD-4.1

TITLE	SNT-6A-A -Land Recommendation
No.	PG006-A-L-SD-4.1
ANGLE	
UNIT	mm
<b>ABLIC Inc.</b>	

## Disclaimers (Handling Precautions)

1. All the information described herein (product data, specifications, figures, tables, programs, algorithms and application circuit examples, etc.) is current as of publishing date of this document and is subject to change without notice.
2. The circuit examples and the usages described herein are for reference only, and do not guarantee the success of any specific mass-production design.  
ABLIC Inc. is not liable for any losses, damages, claims or demands caused by the reasons other than the products described herein (hereinafter "the products") or infringement of third-party intellectual property right and any other right due to the use of the information described herein.
3. ABLIC Inc. is not liable for any losses, damages, claims or demands caused by the incorrect information described herein.
4. Be careful to use the products within their ranges described herein. Pay special attention for use to the absolute maximum ratings, operation voltage range and electrical characteristics, etc.  
ABLIC Inc. is not liable for any losses, damages, claims or demands caused by failures and / or accidents, etc. due to the use of the products outside their specified ranges.
5. Before using the products, confirm their applications, and the laws and regulations of the region or country where they are used and verify suitability, safety and other factors for the intended use.
6. When exporting the products, comply with the Foreign Exchange and Foreign Trade Act and all other export-related laws, and follow the required procedures.
7. The products are strictly prohibited from using, providing or exporting for the purposes of the development of weapons of mass destruction or military use. ABLIC Inc. is not liable for any losses, damages, claims or demands caused by any provision or export to the person or entity who intends to develop, manufacture, use or store nuclear, biological or chemical weapons or missiles, or use any other military purposes.
8. The products are not designed to be used as part of any device or equipment that may affect the human body, human life, or assets (such as medical equipment, disaster prevention systems, security systems, combustion control systems, infrastructure control systems, vehicle equipment, traffic systems, in-vehicle equipment, aviation equipment, aerospace equipment, and nuclear-related equipment), excluding when specified for in-vehicle use or other uses by ABLIC, Inc. Do not apply the products to the above listed devices and equipments.  
ABLIC Inc. is not liable for any losses, damages, claims or demands caused by unauthorized or unspecified use of the products.
9. In general, semiconductor products may fail or malfunction with some probability. The user of the products should therefore take responsibility to give thorough consideration to safety design including redundancy, fire spread prevention measures, and malfunction prevention to prevent accidents causing injury or death, fires and social damage, etc. that may ensue from the products' failure or malfunction.  
The entire system in which the products are used must be sufficiently evaluated and judged whether the products are allowed to apply for the system on customer's own responsibility.
10. The products are not designed to be radiation-proof. The necessary radiation measures should be taken in the product design by the customer depending on the intended use.
11. The products do not affect human health under normal use. However, they contain chemical substances and heavy metals and should therefore not be put in the mouth. The fracture surfaces of wafers and chips may be sharp. Be careful when handling these with the bare hands to prevent injuries, etc.
12. When disposing of the products, comply with the laws and ordinances of the country or region where they are used.
13. The information described herein contains copyright information and know-how of ABLIC Inc. The information described herein does not convey any license under any intellectual property rights or any other rights belonging to ABLIC Inc. or a third party. Reproduction or copying of the information from this document or any part of this document described herein for the purpose of disclosing it to a third-party is strictly prohibited without the express permission of ABLIC Inc.
14. For more details on the information described herein or any other questions, please contact ABLIC Inc.'s sales representative.
15. This Disclaimers have been delivered in a text using the Japanese language, which text, despite any translations into the English language and the Chinese language, shall be controlling.

2.4-2019.07

# Mouser Electronics

Authorized Distributor

Click to View Pricing, Inventory, Delivery & Lifecycle Information:

## ABLIC:

[S-8211EAC-M5T1U](#) [S-8211EAB-I6T1U](#) [S-8211EAA-I6T1U](#) [S-8211EAE-I6T1U](#) [S-8211EAD-I6T1U](#) [S-8211EAF-M5T1U](#) [S-8211EAL-M5T1U](#) [S-8211EAP-I6T1U](#) [S-8211EAO-M5T1U](#) [S-8211EAN-M5T1U](#) [S-8211EAJ-M5T1U](#) [S-8211EAM-M5T1U](#) [S-8211EAI-I6T1U](#) [S-8211EAK-M5T1U](#) [S-8211EAH-I6T1U](#) [S-8211EAB-M5T1U](#) [S-8211EAG-M5T1U](#)

Компания «Life Electronics» занимается поставками электронных компонентов импортного и отечественного производства от производителей и со складов крупных дистрибьюторов Европы, Америки и Азии.

С конца 2013 года компания активно расширяет линейку поставок компонентов по направлению коаксиальный кабель, кварцевые генераторы и конденсаторы (керамические, пленочные, электролитические), за счёт заключения дистрибьюторских договоров

Мы предлагаем:

- Конкурентоспособные цены и скидки постоянным клиентам.
- Специальные условия для постоянных клиентов.
- Подбор аналогов.
- Поставку компонентов в любых объемах, удовлетворяющих вашим потребностям.
- Приемлемые сроки поставки, возможна ускоренная поставка.
- Доставку товара в любую точку России и стран СНГ.
- Комплексную поставку.
- Работу по проектам и поставку образцов.
- Формирование склада под заказчика.
- Сертификаты соответствия на поставляемую продукцию (по желанию клиента).
- Тестирование поставляемой продукции.
- Поставку компонентов, требующих военную и космическую приемку.
- Входной контроль качества.
- Наличие сертификата ISO.

В составе нашей компании организован Конструкторский отдел, призванный помогать разработчикам, и инженерам.

Конструкторский отдел помогает осуществить:

- Регистрацию проекта у производителя компонентов.
- Техническую поддержку проекта.
- Защиту от снятия компонента с производства.
- Оценку стоимости проекта по компонентам.
- Изготовление тестовой платы монтаж и пусконаладочные работы.



Тел: +7 (812) 336 43 04 (многоканальный)  
Email: [org@lifeelectronics.ru](mailto:org@lifeelectronics.ru)