



The full plastic circular connector

UTP provides the complete answer to the need for economical lightweight and robust circular connector



Flammability rating ■ UL94-V0 compliant

Rapid and secure locking ■ Locks with audible positive «click»

Interconnectivité & intermariable ■ Intermateable and interchangeable with UTO, UTG and UTS Series

Complete range of contacts ■ Trim Trio contacts #16

Layout

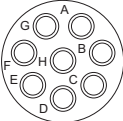
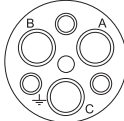
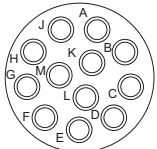
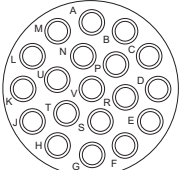
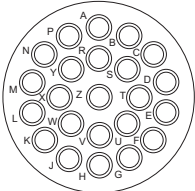
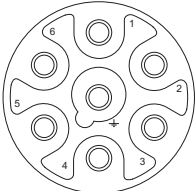
| Shell size | Contact # 16 (Ø 1,6) | Mixed power / signal versions |
|------------|--|---|
| 10 |  <p>10-4</p> |  <p>10-3 3 x #16 (Ø 1,6) Group C 250V</p> |
| 12 |  <p>12-8</p> |  <p>12-2G1</p> |
| 14 |  <p>14-12</p> | |
| 16 |  <p>16-19</p> | |
| 18 |  <p>18-23</p> |  <p>18-7 Group C 380V 7 x # 16 (Ø 1,6)</p> |

UTP Series

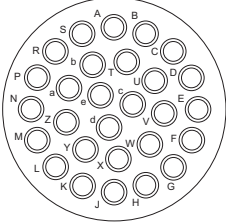
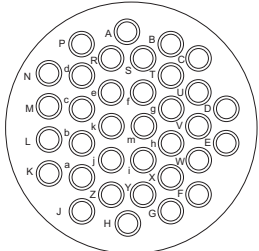
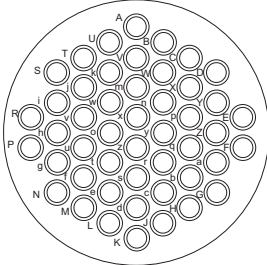
| Shell size | Contact # 16 (Ø 1,6) | Mixed power / signal versions |
|------------|--|-------------------------------|
| 20 |  <p style="text-align: center;">20-28</p> | |
| 22 |  <p style="text-align: center;">22-35</p> | |
| 24 |  <p style="text-align: center;">24-48</p> | |

Contact identification positions shown are for mating face of pin contact connectors and wire face of socket contact connectors.

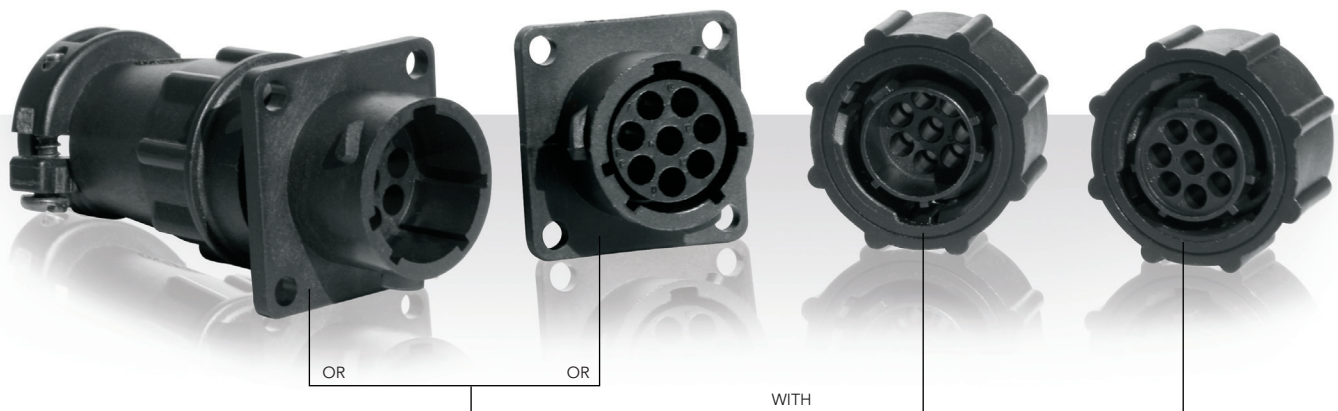

Specifications

| Connector type | Shell size | Contacts number* | Part number | |
|---------------------------|------------|------------------|-------------|---------------|
| | | | Male insert | Female insert |
| Cable plug | 10 | 4 | UTP6104P | UTP6104S |
| | | | UTP6103P | UTP6103S |
| | 12 | 8 | UTP6128P | UTP6128S |
| | | | 2 + ground | UTP6122G1P |
| | 14 | 12 | UTP61412P | UTP61412S |
| | 16 | 19 | UTP61619P | UTP61619S |
| | 18 | 23 | UTP61823P | UTP61823S |
| | | | 6 + ground | UTP6187P |
| 20 | 28 | UTP62028P | UTP62028S | |
| 22 | 35 | UTP62235P | UTP62235S | |
| 24 | 48 | UTP62448P | UTP62448S | |
| Panel mounting receptacle | 10 | 4 | UTP0104P | UTP0104S |
| | | | UTP0103P | UTP0103S |
| | 12 | 8 | UTP0128P | UTP0128S |
| | | | 2 + ground | UTP0122G1P |
| | 14 | 12 | UTP01412P | UTP01412S |
| | 16 | 19 | UTP01619P | UTP01619S |
| | 18 | 23 | UTP01823P | UTP01823S |
| | | | 6 + ground | UTP0187P |
| 20 | 28 | UTP02028P | UTP02028S | |
| 22 | 35 | UTP02235P | UTP02235S | |
| 24 | 48 | UTP02448P | UTP02448S | |

*Contacts supply separately

Dimensions

Cable Plug - UTP6

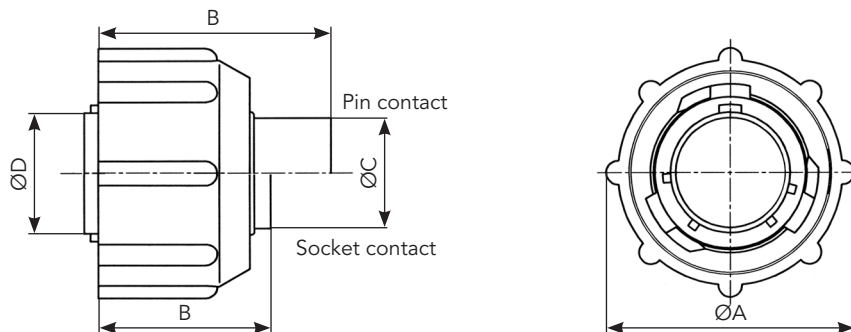

| Shell size | ØA ^{±0.2} | B max | | ØC ^{±0.15} | ØD ^{±0.15} | ØE ^{±0.2} |
|------------|--------------------|-------------|----------------|---------------------|---------------------|--------------------|
| | | Pin contact | Socket contact | | | |
| 10 | 26.7 | 31.8 | 23.9 / 26.75 | 10.9 | 12.2 | 19.1 |
| 12 | 31.4 | | 23.9 | 13.8 | 15.1 | |
| 14 | 34.5 | | | 17.0 | 18.3 | |
| 16 | 37.8 | | 19.9 | 21.5 | | |
| 18 | 40.8 | 31.8 / 33.0 | 23.9 / 29.0 | 22.4 | 24.0 | |
| 20 | 43.9 | 31.8 | 24.9 | 25.6 | 27.2 | |
| 22 | 47.0 | | | 28.5 | 30.4 | |
| 24 | 50.1 | | | 31.7 | 33.5 | |

Panel Mounting - UTP0

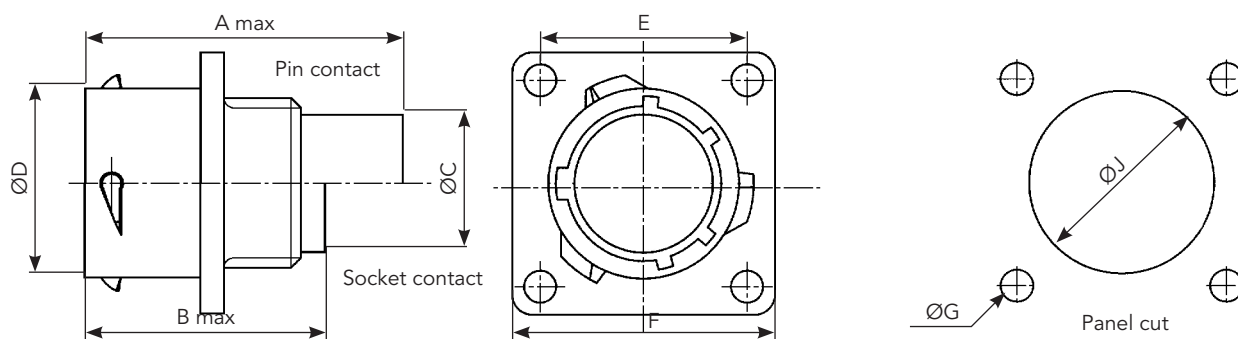

| Shell size | A max | | B ^{±0.15} | C ^{±0.2} | ØD ^{±0.15} | ØE ^{±0.2} | F ^{±0.25} | ØG ^{±0.1} | ØJ ^{±0.1} |
|------------|-------------|----------------|--------------------|-------------------|---------------------|--------------------|--------------------|--------------------|--------------------|
| | Pin contact | Socket contact | | | | | | | |
| 10 | 31.7 | 24.3 / 27.6 | 2.3 | 11.3 | 15.0 | 18.3 | 23.8 | 3.2 | 15.1 |
| 12 | | 24.3 | | | 19.0 | 20.6 | 26.2 | | 18.2 |
| 14 | | | | | 22.2 | 23.0 | 28.6 | | 21.4 |
| 16 | | 25.3 | | | 24.6 | 31.0 | 24.6 | | |
| 18 | 31.7 / 34.0 | 24.3 / 30.4 | 2.5 | 11.3 / 17.9 | 28.5 | 27.0 | 33.3 | | 27.7 |
| 20 | 33.3 | 27.0 | 3.5 | 14.5 | 31.7 | 29.4 | 36.5 | | 30.9 |
| 22 | | 28.0 | | | 34.9 | 31.8 | 39.7 | | 34.1 |
| 24 | | 30.4 | | | 38.0 | 34.9 | 42.9 | | 3.9 |

Note: all dimensions are in mm

Accessories and tooling

Cable Clamp



| Part number | Shell size |
|-------------|------------|
| UTG10AC | 10 |
| UTG12AC | 12 |
| UTG14AC | 14 |
| UTG16AC | 16 |
| UTG18AC | 18 |
| UTG20AC | 20 |
| UTG22AC | 22 |
| UTG24AC | 24 |

Cable Clamp for Waterprotected (IP65) Applications



| Part number | Shell size |
|-------------|------------|
| UTG10PG | 10 |
| UTG12PG | 12 |
| UTG14PG | 14 |
| UTG16PG | 16 |
| UTG18PG | 18 |
| UTG20PG | 20 |
| UTG22PG | 22 |
| UTG24PG | 24 |

Cable Gland for Waterprotected (IP65) Applications



| Part number | Shell size |
|-------------|------------|
| UTG10ST | 10 |
| UTG12ST | 12 |
| UTG14ST | 14 |
| UTG16ST | 16 |
| UTG18ST | 18 |
| UTG20ST | 20 |
| UTG22ST | 22 |
| UTG24ST | 24 |

Metal Shrink Boot



| Part number | Shell size |
|-------------|------------|
| UTG10AD | 10 |
| UTG12AD | 12 |
| UTG14AD | 14 |
| UTG16AD | 16 |
| UTG18AD | 18 |
| UTG20AD | 20 |
| UTG22AD | 22 |
| UTG24AD | 24 |

Dustcap (Receptacle)



| Part number | Shell size |
|-------------|------------|
| UTP10DC | 10 |
| UTP12DC | 12 |
| UTP14DC | 14 |
| UTP16DC | 16 |
| UTP18DC | 18 |
| UTP20DC | 20 |
| UTP22DC | 22 |
| UTP24DC | 24 |

Dustcap with Chain (Receptacle)



| Part number | Shell size |
|-------------|------------|
| UTP10DCG | 10 |
| UTP12DCG | 12 |
| UTP14DCG | 14 |
| UTP16DCG | 16 |
| UTP18DCG | 18 |
| UTP20DCG | 20 |
| UTP22DCG | 22 |
| UTP24DCG | 24 |

Plastic Protective Cap for Receptacle



| Part number | Shell size |
|-------------|------------|
| 8500-5586A | 10 |
| 8500-5587A | 12 |
| 8500-5588A | 14 |
| 8500-5589A | 16 |
| 8500-5590A | 18 |
| 8500-5591A | 20 |
| 8500-5592A | 22 |
| 8500-5593A | 24 |

Gasket



| Part number | Shell size |
|-------------|------------|
| UTFD12B | 10 |
| UTFD13B | 12 |
| UTFD14B | 14 |
| UTFD15B | 16 |
| UTFD16B | 18 |
| UTFD17B | 20 |
| UTFD18B | 22 |
| UTFD19B | 24 |

Handle



Part number
SHANDLES

Tool Kit



Part number
TOOLKIT

Crimp Tooling

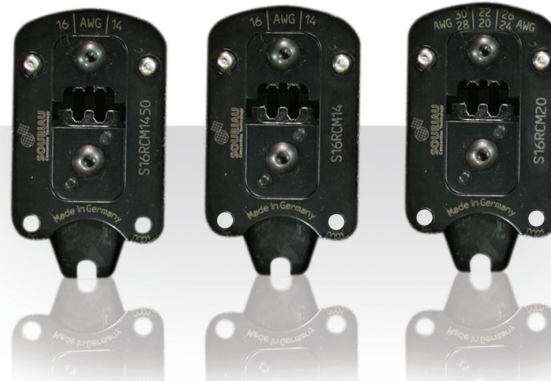

| Contacts | Contact size | Part number of head | |
|--------------------------------|---|---------------------|---|
| RM/RC 28M1K ⁽¹⁾ | Standard contacts #16 Ø 1.6mm | S16RCM20* | |
| RM/RC 24M9K ⁽¹⁾ | | S16RCM20* | |
| RM/RC 20M13K ⁽¹⁾ | | S16RCM20* | |
| RM/RC 20M12K ⁽¹⁾ | | S16RCM20* | |
| RM/RC 16M23K ⁽¹⁾ | | S16RCM16* | |
| RM/RC 14M30K ⁽¹⁾ | | S16RCM14* | |
| SM/SC 24ML1TK6 ⁽¹⁾ | | S16SCM20* | |
| SM/SC 20ML1TK6 ⁽¹⁾ | | S16SCM20* | |
| SM/SC 16ML1TK6 ⁽¹⁾ | | S16SCML1* | |
| SM/SC 14ML1TK6 ⁽¹⁾ | | S16SCML1* | |
| SM/SC 16ML11TK6 ⁽¹⁾ | | S16SCML11* | |
| RMDXK10D28K | | Coaxial contacts | M10S-1J with die set & stop bushing |
| RCDXK1D28K | | | |
| RM/RC DX60xxD28K | | | |
| RM/RC DXK10D28 + york090 | | | |
| RM/RC DX60xxD28 | | | |

(1): example of plating, for other plating contact us

* Heads to be used with Handle PN: SHANDLES

SOURIAU

souriau-industrial.com

contactindustry@souriau.com



Компания «Life Electronics» занимается поставками электронных компонентов импортного и отечественного производства от производителей и со складов крупных дистрибьюторов Европы, Америки и Азии.

С конца 2013 года компания активно расширяет линейку поставок компонентов по направлению коаксиальный кабель, кварцевые генераторы и конденсаторы (керамические, пленочные, электролитические), за счёт заключения дистрибьюторских договоров

Мы предлагаем:

- Конкурентоспособные цены и скидки постоянным клиентам.
- Специальные условия для постоянных клиентов.
- Подбор аналогов.
- Поставку компонентов в любых объемах, удовлетворяющих вашим потребностям.
- Приемлемые сроки поставки, возможна ускоренная поставка.
- Доставку товара в любую точку России и стран СНГ.
- Комплексную поставку.
- Работу по проектам и поставку образцов.
- Формирование склада под заказчика.
- Сертификаты соответствия на поставляемую продукцию (по желанию клиента).
- Тестирование поставляемой продукции.
- Поставку компонентов, требующих военную и космическую приемку.
- Входной контроль качества.
- Наличие сертификата ISO.

В составе нашей компании организован Конструкторский отдел, призванный помогать разработчикам, и инженерам.

Конструкторский отдел помогает осуществить:

- Регистрацию проекта у производителя компонентов.
- Техническую поддержку проекта.
- Защиту от снятия компонента с производства.
- Оценку стоимости проекта по компонентам.
- Изготовление тестовой платы монтаж и пусконаладочные работы.



Тел: +7 (812) 336 43 04 (многоканальный)
Email: org@lifeelectronics.ru