



## The full plastic circular connector

UTP provides the complete answer to the need for economical lightweight and robust circular connector



**Flammability rating** ■ UL94-V0 compliant

**Rapid and secure locking** ■ Locks with audible positive «click»

**Interconnectivité & intermariable** ■ Intermateable and interchangeable with UTO, UTG and UTS Series

**Complete range of contacts** ■ Trim Trio contacts #16

## Layout

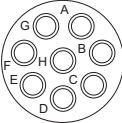
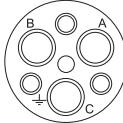
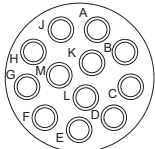
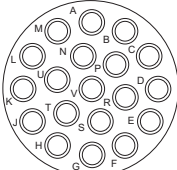
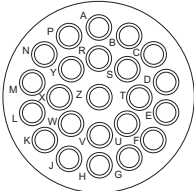
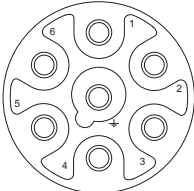
Shell size	Contact # 16 (Ø 1,6)	Mixed power / signal versions
10	 <p>10-4</p>	 <p>10-3 3 x #16 (Ø 1,6) Group C 250V</p>
12	 <p>12-8</p>	 <p>12-2G1</p>
14	 <p>14-12</p>	
16	 <p>16-19</p>	
18	 <p>18-23</p>	 <p>18-7 Group C 380V 7 x # 16 (Ø 1,6)</p>

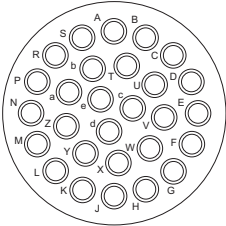
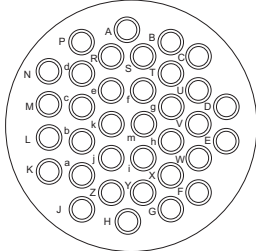
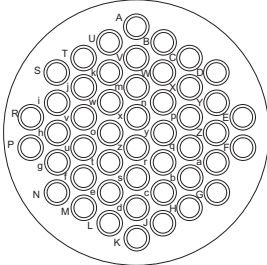
Shell size	Contact # 16 (Ø 1,6)	Mixed power / signal versions
20	 <p data-bbox="591 663 656 688">20-28</p>	
22	 <p data-bbox="591 1075 656 1100">22-35</p>	
24	 <p data-bbox="591 1461 656 1486">24-48</p>	

Contact identification positions shown are for mating face of pin contact connectors and wire face of socket contact connectors.

# UTP Series

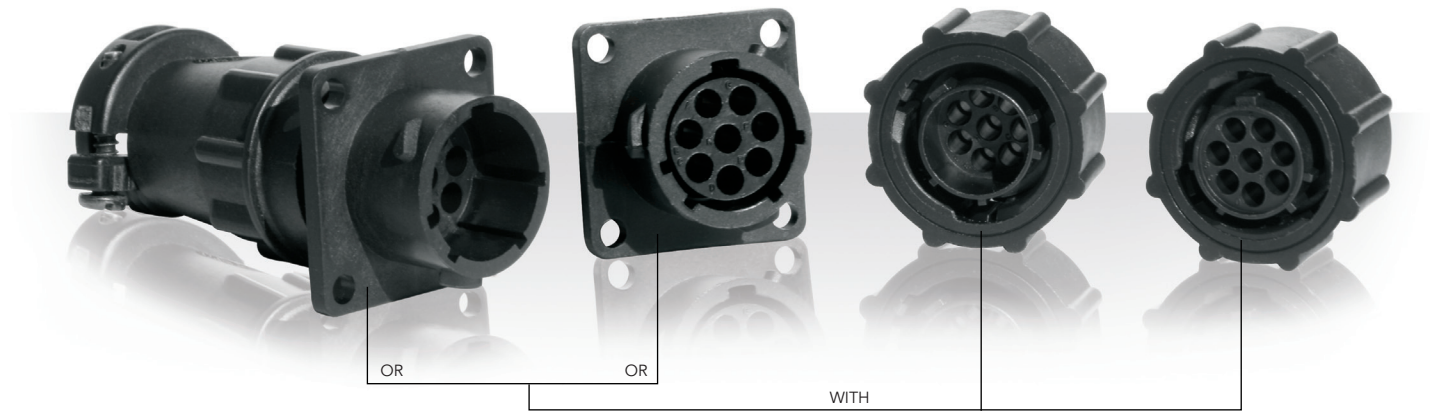

## Specifications

Connector type	Shell size	Contacts number*	Part number	
			Male insert	Female insert
Cable plug	10	4	UTP6104P	UTP6104S
			UTP6103P	UTP6103S
	12	8	UTP6128P	UTP6128S
			2 + ground	UTP6122G1P
	14	12	UTP61412P	UTP61412S
	16	19	UTP61619P	UTP61619S
	18	23	UTP61823P	UTP61823S
			6 + ground	UTP6187P
20	28	UTP62028P	UTP62028S	
22	35	UTP62235P	UTP62235S	
24	48	UTP62448P	UTP62448S	
Panel mounting receptacle	10	4	UTP0104P	UTP0104S
			UTP0103P	UTP0103S
	12	8	UTP0128P	UTP0128S
			2 + ground	UTP0122G1P
	14	12	UTP01412P	UTP01412S
	16	19	UTP01619P	UTP01619S
	18	23	UTP01823P	UTP01823S
			6 + ground	UTP0187P
20	28	UTP02028P	UTP02028S	
22	35	UTP02235P	UTP02235S	
24	48	UTP02448P	UTP02448S	

\*Contacts supply separately

## Dimensions

### Cable Plug - UTP6

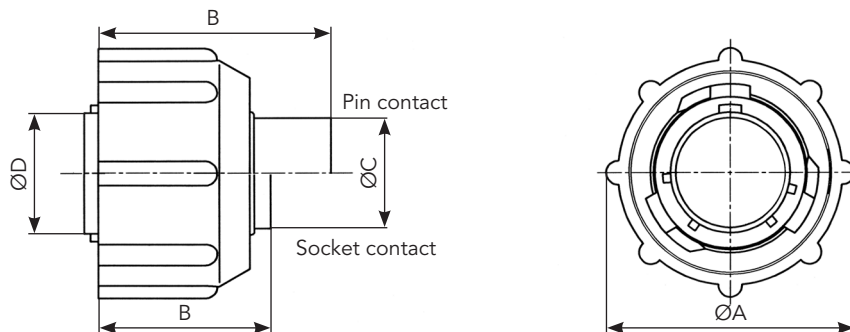

Shell size	ØA <sup>±0.2</sup>	B max		ØC <sup>±0.15</sup>	ØD <sup>±0.15</sup>	ØE <sup>±0.2</sup>
		Pin contact	Socket contact			
10	26.7	31.8	23.9 / 26.75	10.9	12.2	19.1
12	31.4		23.9	13.8	15.1	
14	34.5			17.0	18.3	
16	37.8		19.9	21.5		
18	40.8	31.8 / 33.0	23.9 / 29.0	22.4	24.0	
20	43.9	31.8	24.9	25.6	27.2	
22	47.0			28.5	30.4	
24	50.1			31.7	33.5	

### Panel Mounting - UTP0



Shell size	A max		B <sup>±0.15</sup>	C <sup>±0.2</sup>	ØD <sup>±0.15</sup>	ØE <sup>±0.2</sup>	F <sup>±0.25</sup>	ØG <sup>±0.1</sup>	ØJ <sup>±0.1</sup>
	Pin contact	Socket contact							
10	31.7	24.3 / 27.6	2.3	11.3	15.0	18.3	23.8	3.2	15.1
12		24.3			19.0	20.6	26.2		18.2
14					22.2	23.0	28.6		21.4
16		25.3			24.6	31.0	24.6		
18	31.7 / 34.0	24.3 / 30.4	2.5	11.3 / 17.9	28.5	27.0	33.3		27.7
20	33.3	27.0	3.5	14.5	31.7	29.4	36.5		30.9
22		28.0			34.9	31.8	39.7		34.1
24		30.4			15.3	38.0	34.9		42.9

Note: all dimensions are in mm

## Accessories and tooling

### Cable Clamp



Part number	Shell size
UTG10AC	10
UTG12AC	12
UTG14AC	14
UTG16AC	16
UTG18AC	18
UTG20AC	20
UTG22AC	22
UTG24AC	24

### Cable Clamp for Waterprotected (IP65) Applications



Part number	Shell size
UTG10PG	10
UTG12PG	12
UTG14PG	14
UTG16PG	16
UTG18PG	18
UTG20PG	20
UTG22PG	22
UTG24PG	24

### Cable Gland for Waterprotected (IP65) Applications



Part number	Shell size
UTG10ST	10
UTG12ST	12
UTG14ST	14
UTG16ST	16
UTG18ST	18
UTG20ST	20
UTG22ST	22
UTG24ST	24

### Metal Shrink Boot



Part number	Shell size
UTG10AD	10
UTG12AD	12
UTG14AD	14
UTG16AD	16
UTG18AD	18
UTG20AD	20
UTG22AD	22
UTG24AD	24

### Dustcap (Receptacle)



Part number	Shell size
UTP10DC	10
UTP12DC	12
UTP14DC	14
UTP16DC	16
UTP18DC	18
UTP20DC	20
UTP22DC	22
UTP24DC	24

### Dustcap with Chain (Receptacle)



Part number	Shell size
UTP10DCG	10
UTP12DCG	12
UTP14DCG	14
UTP16DCG	16
UTP18DCG	18
UTP20DCG	20
UTP22DCG	22
UTP24DCG	24

## Plastic Protective Cap for Receptacle



Part number	Shell size
8500-5586A	10
8500-5587A	12
8500-5588A	14
8500-5589A	16
8500-5590A	18
8500-5591A	20
8500-5592A	22
8500-5593A	24

## Gasket



Part number	Shell size
UTFD12B	10
UTFD13B	12
UTFD14B	14
UTFD15B	16
UTFD16B	18
UTFD17B	20
UTFD18B	22
UTFD19B	24

## Handle



Part number  
SHANDLES

## Tool Kit



Part number  
TOOLKIT

## Crimp Tooling



Contacts	Contact size	Part number of head	
RM/RC 28M1K <sup>(1)</sup>	Standard contacts  #16 Ø 1.6mm	S16RCM20*	
RM/RC 24M9K <sup>(1)</sup>		S16RCM20*	
RM/RC 20M13K <sup>(1)</sup>		S16RCM20*	
RM/RC 20M12K <sup>(1)</sup>		S16RCM20*	
RM/RC 16M23K <sup>(1)</sup>		S16RCM16*	
RM/RC 14M30K <sup>(1)</sup>		S16RCM14*	
SM/SC 24ML1TK6 <sup>(1)</sup>		S16SCM20*	
SM/SC 20ML1TK6 <sup>(1)</sup>		S16SCM20*	
SM/SC 16ML1TK6 <sup>(1)</sup>		S16SCML1*	
SM/SC 14ML1TK6 <sup>(1)</sup>		S16SCML1*	
SM/SC 16ML11TK6 <sup>(1)</sup>		S16SCML11*	
RMDXK10D28K		Coaxial contacts	M10S-1J with die set & stop bushing
RCDXK1D28K			
RM/RC DX60xxD28K			
RM/RC DXK10D28 + york090			
RM/RC DX60xxD28			

(1): example of plating, for other plating contact us

\* Heads to be used with Handle PN: SHANDLES

# SOURIAU

souriau-industrial.com

contactindustry@souriau.com





Компания «Life Electronics» занимается поставками электронных компонентов импортного и отечественного производства от производителей и со складов крупных дистрибьюторов Европы, Америки и Азии.

С конца 2013 года компания активно расширяет линейку поставок компонентов по направлению коаксиальный кабель, кварцевые генераторы и конденсаторы (керамические, пленочные, электролитические), за счёт заключения дистрибьюторских договоров

Мы предлагаем:

- Конкурентоспособные цены и скидки постоянным клиентам.
- Специальные условия для постоянных клиентов.
- Подбор аналогов.
- Поставку компонентов в любых объемах, удовлетворяющих вашим потребностям.
- Приемлемые сроки поставки, возможна ускоренная поставка.
- Доставку товара в любую точку России и стран СНГ.
- Комплексную поставку.
- Работу по проектам и поставку образцов.
- Формирование склада под заказчика.
- Сертификаты соответствия на поставляемую продукцию (по желанию клиента).
- Тестирование поставляемой продукции.
- Поставку компонентов, требующих военную и космическую приемку.
- Входной контроль качества.
- Наличие сертификата ISO.

В составе нашей компании организован Конструкторский отдел, призванный помогать разработчикам, и инженерам.

Конструкторский отдел помогает осуществить:

- Регистрацию проекта у производителя компонентов.
- Техническую поддержку проекта.
- Защиту от снятия компонента с производства.
- Оценку стоимости проекта по компонентам.
- Изготовление тестовой платы монтаж и пусконаладочные работы.



Тел: +7 (812) 336 43 04 (многоканальный)  
Email: [org@lifeelectronics.ru](mailto:org@lifeelectronics.ru)