



The full plastic circular connector

UTP provides the complete answer to the need for economical lightweight and robust circular connector



Flammability rating ■ UL94-V0 compliant

Rapid and secure locking ■ Locks with audible positive «click»

Interconnectivité & intermariable ■ Intermateable and interchangeable with UTO, UTG and UTS Series

Complete range of contacts ■ Trim Trio contacts #16

Layout

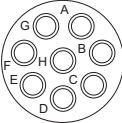
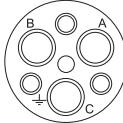
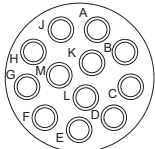
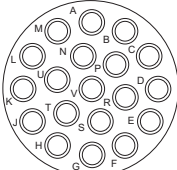
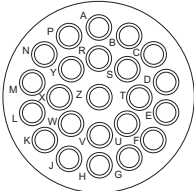
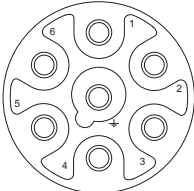
Shell size	Contact # 16 (Ø 1,6)	Mixed power / signal versions
10	 <p>10-4</p>	 <p>10-3 3 x #16 (Ø 1,6) Group C 250V</p>
12	 <p>12-8</p>	 <p>12-2G1</p>
14	 <p>14-12</p>	
16	 <p>16-19</p>	
18	 <p>18-23</p>	 <p>18-7 Group C 380V 7 x # 16 (Ø 1,6)</p>

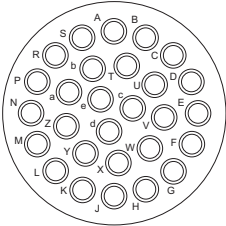
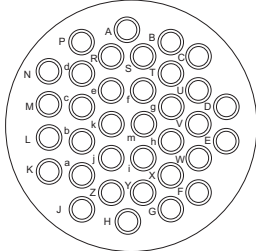
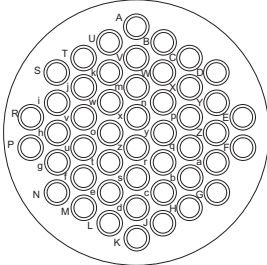
Shell size	Contact # 16 (Ø 1,6)	Mixed power / signal versions
20	 <p data-bbox="591 663 656 688">20-28</p>	
22	 <p data-bbox="591 1073 656 1098">22-35</p>	
24	 <p data-bbox="591 1461 656 1486">24-48</p>	

Contact identification positions shown are for mating face of pin contact connectors and wire face of socket contact connectors.

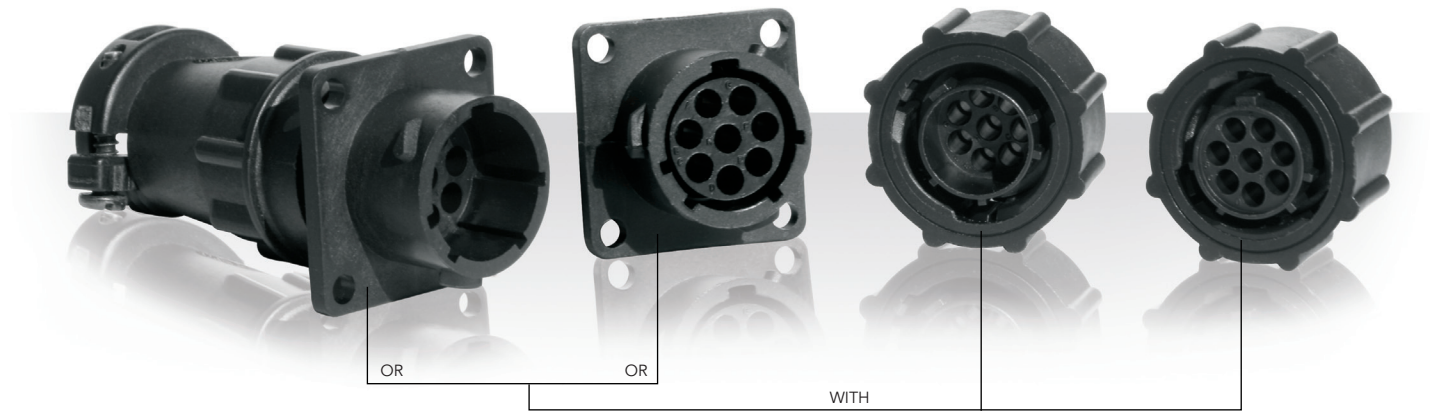

Specifications

Connector type	Shell size	Contacts number*	Part number	
			Male insert	Female insert
Cable plug	10	4	UTP6104P	UTP6104S
			UTP6103P	UTP6103S
	12	8	UTP6128P	UTP6128S
			2 + ground	UTP6122G1P
	14	12	UTP61412P	UTP61412S
	16	19	UTP61619P	UTP61619S
	18	23	UTP61823P	UTP61823S
			6 + ground	UTP6187P
20	28	UTP62028P	UTP62028S	
22	35	UTP62235P	UTP62235S	
24	48	UTP62448P	UTP62448S	
Panel mounting receptacle	10	4	UTP0104P	UTP0104S
			UTP0103P	UTP0103S
	12	8	UTP0128P	UTP0128S
			2 + ground	UTP0122G1P
	14	12	UTP01412P	UTP01412S
	16	19	UTP01619P	UTP01619S
	18	23	UTP01823P	UTP01823S
			6 + ground	UTP0187P
20	28	UTP02028P	UTP02028S	
22	35	UTP02235P	UTP02235S	
24	48	UTP02448P	UTP02448S	

*Contacts supply separately

Dimensions

Cable Plug - UTP6

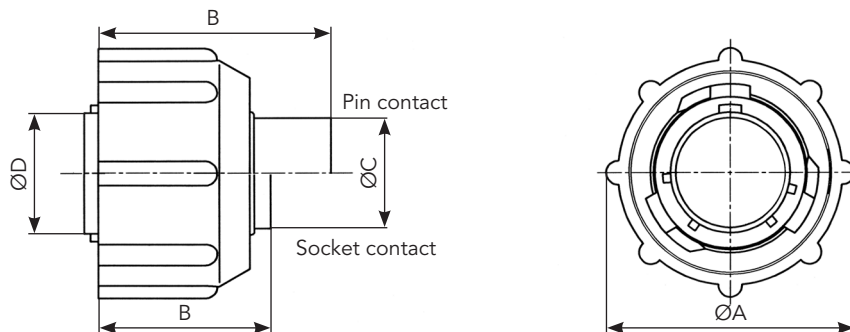

Shell size	ØA ^{±0.2}	B max		ØC ^{±0.15}	ØD ^{±0.15}	ØE ^{±0.2}
		Pin contact	Socket contact			
10	26.7	31.8	23.9 / 26.75	10.9	12.2	19.1
12	31.4		23.9	13.8	15.1	
14	34.5			17.0	18.3	
16	37.8		19.9	21.5		
18	40.8	31.8 / 33.0	23.9 / 29.0	22.4	24.0	
20	43.9	31.8	24.9	25.6	27.2	
22	47.0			28.5	30.4	
24	50.1			31.7	33.5	

Panel Mounting - UTP0

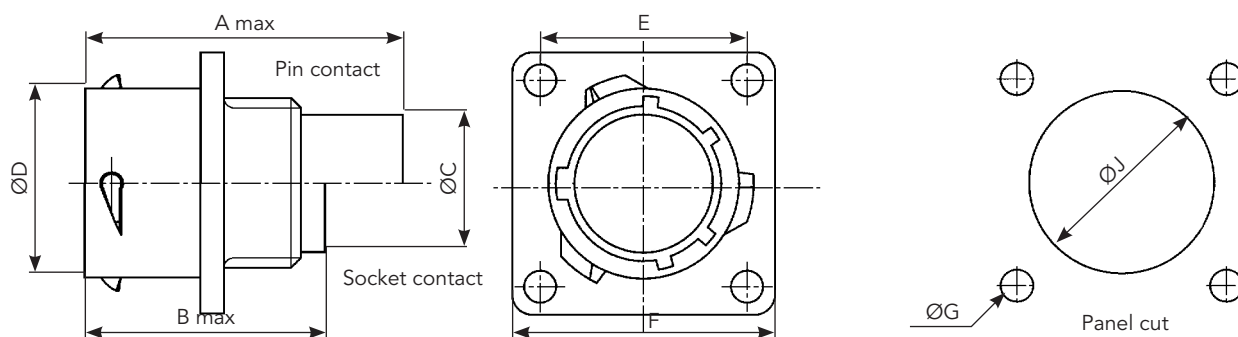

Shell size	A max		B ^{±0.15}	C ^{±0.2}	ØD ^{±0.15}	ØE ^{±0.2}	F ^{±0.25}	ØG ^{±0.1}	ØJ ^{±0.1}
	Pin contact	Socket contact							
10	31.7	24.3 / 27.6	2.3	11.3	15.0	18.3	23.8	3.2	15.1
12		24.3			19.0	20.6	26.2		18.2
14					22.2	23.0	28.6		21.4
16		25.3			24.6	31.0	24.6		
18	31.7 / 34.0	24.3 / 30.4	2.5	11.3 / 17.9	28.5	27.0	33.3		27.7
20	33.3	27.0	3.5	14.5	31.7	29.4	36.5		30.9
22		28.0			34.9	31.8	39.7		34.1
24		30.4			15.3	38.0	34.9		42.9

Note: all dimensions are in mm

Accessories and tooling

Cable Clamp



Part number	Shell size
UTG10AC	10
UTG12AC	12
UTG14AC	14
UTG16AC	16
UTG18AC	18
UTG20AC	20
UTG22AC	22
UTG24AC	24

Cable Clamp for Waterprotected (IP65) Applications



Part number	Shell size
UTG10PG	10
UTG12PG	12
UTG14PG	14
UTG16PG	16
UTG18PG	18
UTG20PG	20
UTG22PG	22
UTG24PG	24

Cable Gland for Waterprotected (IP65) Applications



Part number	Shell size
UTG10ST	10
UTG12ST	12
UTG14ST	14
UTG16ST	16
UTG18ST	18
UTG20ST	20
UTG22ST	22
UTG24ST	24

Metal Shrink Boot



Part number	Shell size
UTG10AD	10
UTG12AD	12
UTG14AD	14
UTG16AD	16
UTG18AD	18
UTG20AD	20
UTG22AD	22
UTG24AD	24

Dustcap (Receptacle)



Part number	Shell size
UTP10DC	10
UTP12DC	12
UTP14DC	14
UTP16DC	16
UTP18DC	18
UTP20DC	20
UTP22DC	22
UTP24DC	24

Dustcap with Chain (Receptacle)



Part number	Shell size
UTP10DCG	10
UTP12DCG	12
UTP14DCG	14
UTP16DCG	16
UTP18DCG	18
UTP20DCG	20
UTP22DCG	22
UTP24DCG	24

Plastic Protective Cap for Receptacle



Part number	Shell size
8500-5586A	10
8500-5587A	12
8500-5588A	14
8500-5589A	16
8500-5590A	18
8500-5591A	20
8500-5592A	22
8500-5593A	24

Gasket



Part number	Shell size
UTFD12B	10
UTFD13B	12
UTFD14B	14
UTFD15B	16
UTFD16B	18
UTFD17B	20
UTFD18B	22
UTFD19B	24

Handle



Part number
SHANDLES

Tool Kit



Part number
TOOLKIT

Crimp Tooling



Contacts	Contact size	Part number of head	
RM/RC 28M1K ⁽¹⁾	Standard contacts #16 Ø 1.6mm	S16RCM20*	
RM/RC 24M9K ⁽¹⁾		S16RCM20*	
RM/RC 20M13K ⁽¹⁾		S16RCM20*	
RM/RC 20M12K ⁽¹⁾		S16RCM20*	
RM/RC 16M23K ⁽¹⁾		S16RCM16*	
RM/RC 14M30K ⁽¹⁾		S16RCM14*	
SM/SC 24ML1TK6 ⁽¹⁾		S16SCM20*	
SM/SC 20ML1TK6 ⁽¹⁾		S16SCM20*	
SM/SC 16ML1TK6 ⁽¹⁾		S16SCML1*	
SM/SC 14ML1TK6 ⁽¹⁾		S16SCML1*	
SM/SC 16ML11TK6 ⁽¹⁾		S16SCML11*	
RMDXK10D28K		Coaxial contacts	M10S-1J with die set & stop bushing
RCDXK1D28K			
RM/RC DX60xxD28K			
RM/RC DXK10D28 + york090			
RM/RC DX60xxD28			

(1): example of plating, for other plating contact us

* Heads to be used with Handle PN: SHANDLES

SOURIAU

souriau-industrial.com

contactindustry@souriau.com



Компания «Life Electronics» занимается поставками электронных компонентов импортного и отечественного производства от производителей и со складов крупных дистрибьюторов Европы, Америки и Азии.

С конца 2013 года компания активно расширяет линейку поставок компонентов по направлению коаксиальный кабель, кварцевые генераторы и конденсаторы (керамические, пленочные, электролитические), за счёт заключения дистрибьюторских договоров

Мы предлагаем:

- Конкурентоспособные цены и скидки постоянным клиентам.
- Специальные условия для постоянных клиентов.
- Подбор аналогов.
- Поставку компонентов в любых объемах, удовлетворяющих вашим потребностям.
- Приемлемые сроки поставки, возможна ускоренная поставка.
- Доставку товара в любую точку России и стран СНГ.
- Комплексную поставку.
- Работу по проектам и поставку образцов.
- Формирование склада под заказчика.
- Сертификаты соответствия на поставляемую продукцию (по желанию клиента).
- Тестирование поставляемой продукции.
- Поставку компонентов, требующих военную и космическую приемку.
- Входной контроль качества.
- Наличие сертификата ISO.

В составе нашей компании организован Конструкторский отдел, призванный помогать разработчикам, и инженерам.

Конструкторский отдел помогает осуществить:

- Регистрацию проекта у производителя компонентов.
- Техническую поддержку проекта.
- Защиту от снятия компонента с производства.
- Оценку стоимости проекта по компонентам.
- Изготовление тестовой платы монтаж и пусконаладочные работы.



Тел: +7 (812) 336 43 04 (многоканальный)

Email: org@lifeelectronics.ru