



Micro Commercial Components



Micro Commercial Components
 20736 Marilla Street Chatsworth
 CA 91311
 Phone: (818) 701-4933
 Fax: (818) 701-4939

MMBD4448HT/ HTA/HTC/HTS

150mW Switching Diodes

Features

- Fast Switching Speed
- For General Purpose Switching Applications
- High Conductance, Power Dissipation
- Ultra-Small Surface Mount Package
- Epoxy meets UL 94 V-0 flammability rating
- Moisture Sensitivity Level 1
- Lead Free Finish/Rohs Compliant ("P" Suffix designates RoHS Compliant. See ordering information)
- Halogen free available upon request by adding suffix "-HF"

Maximum Ratings

Symbol	Rating	Rating	Unit
V_{RM}	Non-Repetitive Peak Reverse Voltage	100	V
V_{RRM}	Peak Repetitive Reverse Voltage	80	V
V_{RWM}	Working Peak Reverse Voltage		
V_R	DC Blocking Voltage		
$V_{R(RMS)}$	RMS Reverse Voltage	57	V
I_{FM}	Forward Continuous Current	500	mA
I_O	Average Rectified Output Current	250	mA
I_{FSM}	Peak Forward Surge Current @ 1.0 μ s	4.0	A
		@ 1.0s	
$R_{\theta JA}$	Thermal Resistance Junction to Ambient	833	$^{\circ}C/W$
P_D	Power dissipation	150	mW
T_J	Junction Temperature	150	$^{\circ}C$
T_{STG}	Storage Temperature	-65 to +150	$^{\circ}C$

Electrical Characteristics @ 25°C Unless Otherwise Specified

Symbol	Parameter	Min	Max	Test Conditions
$V_{(BR)}$	Reverse Breakdown Voltage	80V	---	$I_R=2.5 \mu A$
I_R	Reverse Voltage Leakage Current	---	0.1 μA	$V_R=70V$
			25 nA	$V_R=20V$
V_F	Forward Voltage	0.62	0.72V	$I_F=5.0mA$
		---	0.855V	$I_F=10mA$
		---	1.0V	$I_F=100mA$
		---	1.25V	$I_F=150mA$
C_T	Total Capacitance	---	3.5pF	$V_R=6V, f=1MHz$
t_{rr}	Reverse Recovery Time	---	4.0ns	$I_F=5mA, V_R=6V$

SOT-523

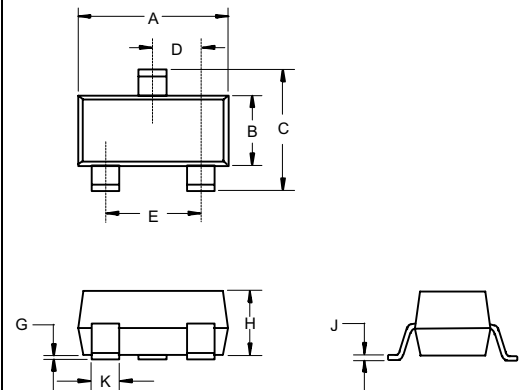

DIM	INCHES		MM		NOTE
	MIN	MAX	MIN	MAX	
A	.059	.067	1.50	1.70	
B	.030	.033	0.75	0.85	
C	.057	.069	1.45	1.75	
D	.020 Nominal		0.50 Nominal		
E	.035	.043	0.90	1.10	
G	.000	.004	.000	.100	
H	.028	.031	.70	0.80	
J	.004	.008	.100	.200	
K	.010	.014	.25	.35	

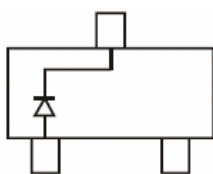

MMBD4448HT Marking: A3

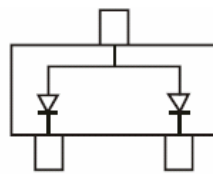

MMBD4448HTA Marking: A6

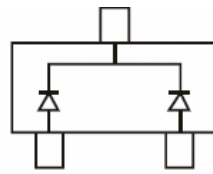

MMBD4448HTC Marking: A7

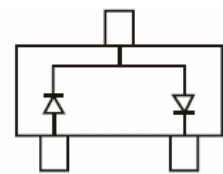

MMBD4448HTS Marking: AB

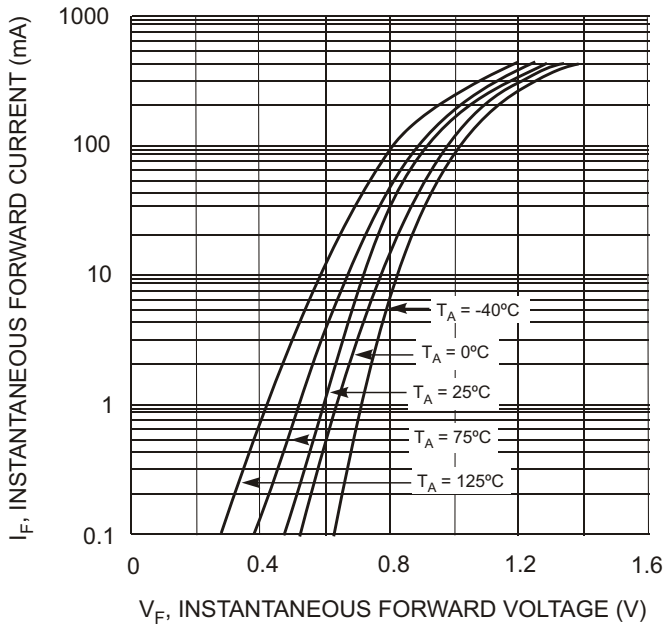

Fig. 1 Typical Forward Characteristics

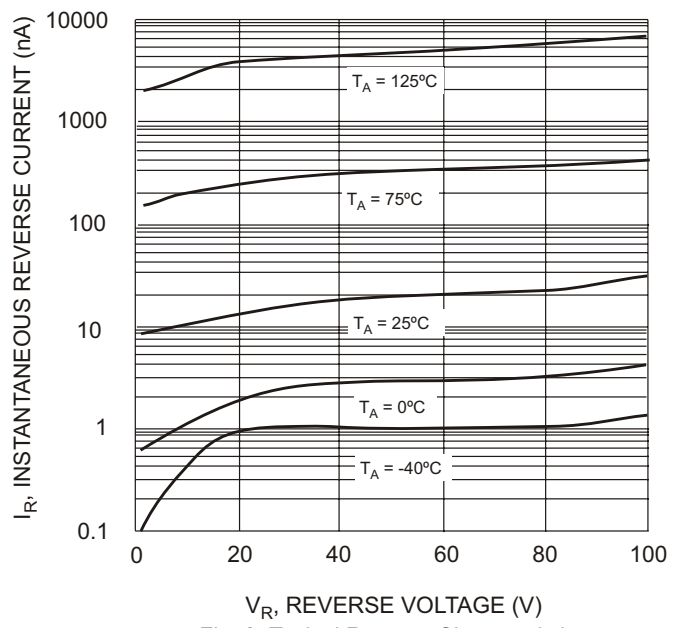

Fig. 2 Typical Reverse Characteristics

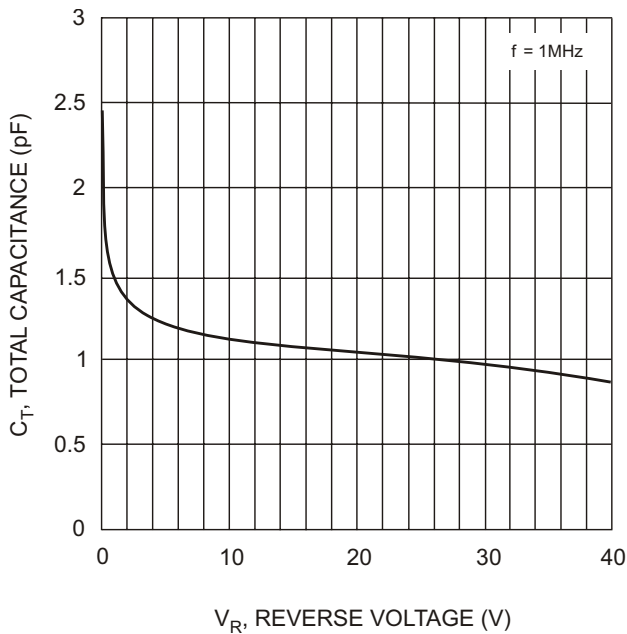

Fig. 3 Typical Capacitance vs. Reverse Voltage

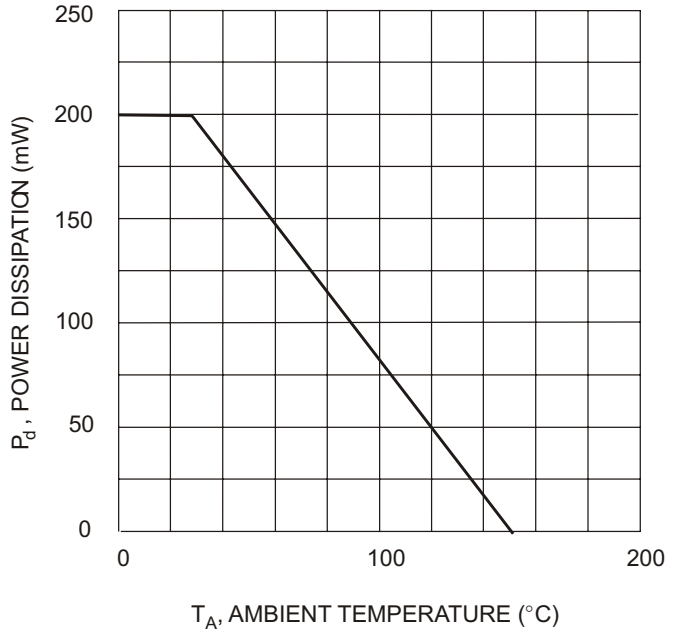

Fig. 4 Power Derating Curve, Total Package



TM

Micro Commercial Components

Ordering Information :

Device	Packing
Part Number-TP	Tape&Reel: 3Kpcs/Reel

Note : Adding "-HF" suffix for halogen free, eg. Part Number-TP-HF

IMPORTANT NOTICE

Micro Commercial Components Corp. reserves the right to make changes without further notice to any product herein to make corrections, modifications , enhancements , improvements , or other changes . **Micro Commercial Components Corp .** does not assume any liability arising out of the application or use of any product described herein; neither does it convey any license under its patent rights ,nor the rights of others . The user of products in such applications shall assume all risks of such use and will agree to hold **Micro Commercial Components Corp .** and all the companies whose products are represented on our website, harmless against all damages.

LIFE SUPPORT

MCC's products are not authorized for use as critical components in life support devices or systems without the express written approval of Micro Commercial Components Corporation.

CUSTOMER AWARENESS

Counterfeiting of semiconductor parts is a growing problem in the industry. Micro Commercial Components (MCC) is taking strong measures to protect ourselves and our customers from the proliferation of counterfeit parts. MCC strongly encourages customers to purchase MCC parts either directly from MCC or from Authorized MCC Distributors who are listed by country on our web page cited below. Products customers buy either from MCC directly or from Authorized MCC Distributors are genuine parts, have full traceability, meet MCC's quality standards for handling and storage. **MCC will not provide any warranty coverage or other assistance for parts bought from Unauthorized Sources.** MCC is committed to combat this global problem and encourage our customers to do their part in stopping this practice by buying direct or from authorized distributors.

www.mccsemi.com

Компания «Life Electronics» занимается поставками электронных компонентов импортного и отечественного производства от производителей и со складов крупных дистрибьюторов Европы, Америки и Азии.

С конца 2013 года компания активно расширяет линейку поставок компонентов по направлению коаксиальный кабель, кварцевые генераторы и конденсаторы (керамические, пленочные, электролитические), за счёт заключения дистрибьюторских договоров

Мы предлагаем:

- Конкуренспособные цены и скидки постоянным клиентам.
- Специальные условия для постоянных клиентов.
- Подбор аналогов.
- Поставку компонентов в любых объемах, удовлетворяющих вашим потребностям.
- Приемлемые сроки поставки, возможна ускоренная поставка.
- Доставку товара в любую точку России и стран СНГ.
- Комплексную поставку.
- Работу по проектам и поставку образцов.
- Формирование склада под заказчика.
- Сертификаты соответствия на поставляемую продукцию (по желанию клиента).
- Тестирование поставляемой продукции.
- Поставку компонентов, требующих военную и космическую приемку.
- Входной контроль качества.
- Наличие сертификата ISO.

В составе нашей компании организован Конструкторский отдел, призванный помогать разработчикам, и инженерам.

Конструкторский отдел помогает осуществить:

- Регистрацию проекта у производителя компонентов.
- Техническую поддержку проекта.
- Защиту от снятия компонента с производства.
- Оценку стоимости проекта по компонентам.
- Изготовление тестовой платы монтаж и пусконаладочные работы.



Тел: +7 (812) 336 43 04 (многоканальный)
Email: org@lifeelectronics.ru