

## Power Relay B

- Pin assignment similar to ISO 7588 part 1
- Plug-in terminals
- Customized versions on request
  - 24VDC versions with contact gap >0.8mm
  - Integrated components (e.g. resistor, diode)
  - Customized marking/color
  - Special covers (e.g. notches, release features, brackets)
  - Various contact arrangements and materials

### Typical applications

Cross carline up to 35A for example: rear window defogger, battery disconnection, power distribution (clamp 15)

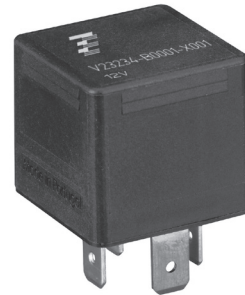

F234\_fw1\_bw

Contact Data	1 A	1 A	1 C	1 C
Contact arrangement	1 form A, 1 NO	1 form A, 1 NO	1 form C, 1 CO	1 form C, 1 CO
Rated voltage	12VDC	24VDC	12VDC	24VDC
Limiting continuous current form A/form B (NO/NC)				
23°C	50A	50A	50/35A	50/35A
85°C	35A	35A	35/25A	35/25A
125°C	15A	15A	15/10A	15/10A
Limiting making current <sup>1)</sup> A/B (NO/NC)	120A	120A	120/45A	120/45A
Limiting breaking current, A/B (NO/NC)	30A	20A	30/20A	20/10A
Limiting short-time current overload current, ISO 8820-3 <sup>2)</sup>		1.35 x 35A, 1800s	2.00 x 35A, 5s	3.50 x 35A, 0.5s
			6.00 x 35A, 0.1s	
Jump start test, ISO 16750-1		24VDC for 5min, conducting nominal current at 23°C		
Contact material		Silver based		
Min. recommended contact load <sup>3)</sup>		1A at 5VDC		
Initial voltage drop, at 10A, typ./max.				
form A (NO)	15/200mV	15/200mV	15/200mV	15/200mV
form B (NC)	-	-	20/250mV	20/250mV
Frequency of operation, at nominal load		6 ops./min (0.1Hz)		
Operate/release time typ.		7/2ms <sup>4)</sup>		
Electrical endurance, ops. <sup>5)</sup>				
resistive load, A (NO)	>2.5x10 <sup>5</sup>	>2.5x10 <sup>5</sup>	>2.5x10 <sup>5</sup>	>2.5x10 <sup>5</sup>
	30A, 14VDC	20A, 28VDC	30A, 14VDC	20A, 28VDC
resistive load, B (NC)	-	-	>1x10 <sup>5</sup>	>2.5x10 <sup>5</sup>
			20A, 14VDC	10A, 28VDC
Mechanical endurance		1x10 <sup>6</sup> ops.		

- 1) The values apply to a resistive or inductive load with suitable spark suppression and at maximum 14VDC for 12VDC or 28VDC for 24VDC load voltages. For a load current duration of maximum 3s for a make/break ratio of 1:10.
- 2) Current and time are compatible with circuit protection by a typical automotive fuse. Relay will make, carry and break the specified current.
- 3) See chapter Diagnostics of Relays in our Application Notes or consult the internet at <http://relays.te.com/appnotes/>
- 4) For unsuppressed relay coil. Any parallel device to the coil will increase the release time.
- 5) Electrical endurance data is not valid for diode versions. Any diode or pn-junction parallel to the coil (internal or external) will significantly decrease the electrical lifetime, especially when used for inductive loads.

Coil Data	
Rated coil voltage	12/24VDC

### Coil versions, DC coil

Coil code	Rated voltage VDC	Operate voltage VDC	Release voltage VDC	Coil resistance <sup>6)</sup> Ω±10%	Rated coil power <sup>6)</sup> W
001	12	8	1.5	85	1.7
002	12	6.5	1	75	1.9
004	24	16	3	255	2.3

6) Without components in parallel.

All figures are given for coil without pre-energization, at ambient temperature +23°C.

### Insulation Data

Initial dielectric strength	
between open contacts	500V <sub>rms</sub>
between contact and coil	500V <sub>rms</sub>
between adjacent contacts	500V <sub>rms</sub>
Load dump test	
ISO 7637-1 (12VDC), test pulse 5	V <sub>s</sub> =+86.5VDC
ISO 7637-2 (24VDC), test pulse 5	V <sub>s</sub> =+200VDC

### Other Data

EU RoHS/ELV compliance	compliant
Protection to heat and fire according UL94	HB or better <sup>7)</sup>
Ambient temperature	-40 to 125°C
Climatic cycling with condensation, EN ISO 6988	6 cycles, storage 8/16h
Temperature cycling, IEC 60068-2-14, Nb	10 cycles, -40/+85°C (5°C/min)
Damp heat cyclic, IEC 60068-2-30, Db, Variant 1	6 cycles, upper air temp. 55°C
Damp heat constant, IEC 60068-2-3, Ca	56 days
Category of environmental protection, IEC 61810	RT I – dustproof
Degree of protection, IEC 60529	IP54
Corrosive gas	
IEC 60068-2-42	10±2cm <sup>3</sup> /m <sup>3</sup> SO <sub>2</sub> , 10 days
IEC 60068-2-43	1±0.3cm <sup>3</sup> /m <sup>3</sup> H <sub>2</sub> S, 10 days
Vibration resistance (functional)	
IEC 60068-2-6 (sine sweep)	10 to 500Hz, min. 5g <sup>8)</sup>
Shock resistance (functional)	
IEC 60068-2-27 (half sine)	11ms, min. 20g <sup>8)</sup>
Drop test, free fall, IEC 60068-2-32	1m onto concrete

7) Refers to used materials.

8) No change in the switching state >10µs. Valid for NC contacts, NO contact values significantly higher.

**Power Relay B** (Continued)

**Other Data** (continued)

Terminal type	plug-in, QC
Cover retention	
pull force	200N
push force	200N
Terminal retention	
pull force	100N
push force	100N
resistance to bending <sup>9)</sup>	10N
force applied to side <sup>9)</sup>	10N
torque	0.3Nm
Weight	approx. 35g (1.2oz)
Packaging unit	200 pcs.

9) Values apply 2mm from the end of the terminal. When the force is removed, the terminal must not have moved by more than 0.3mm.

**Accessories**

For details see datasheet      Connectors for Mini ISO Relays

**Terminal Assignment**

NO  
1 form A, NO

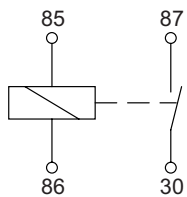

NOR  
1 form A, NO with resistor

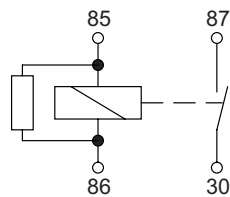

NO\_2x87  
1 form A, 1 NO (2x87)

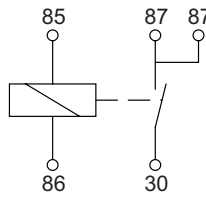

NOR\_2x87  
1 form A, 1 NO (2x87) with resistor

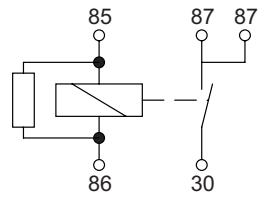

NOD\_2x87  
1 form A, 1 NO (2x87) with diode

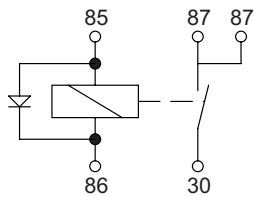

CO  
1 form C, CO

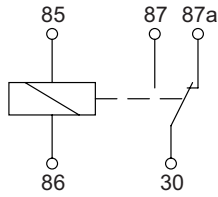

COR  
1 form C, CO with resistor

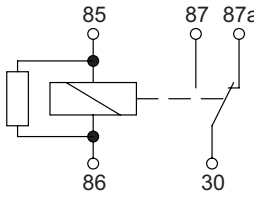

COD  
1 form C, CO with diode

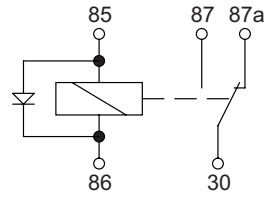

**Power Relay B** (Continued)

**Dimensions**

Power Relay B with bracket

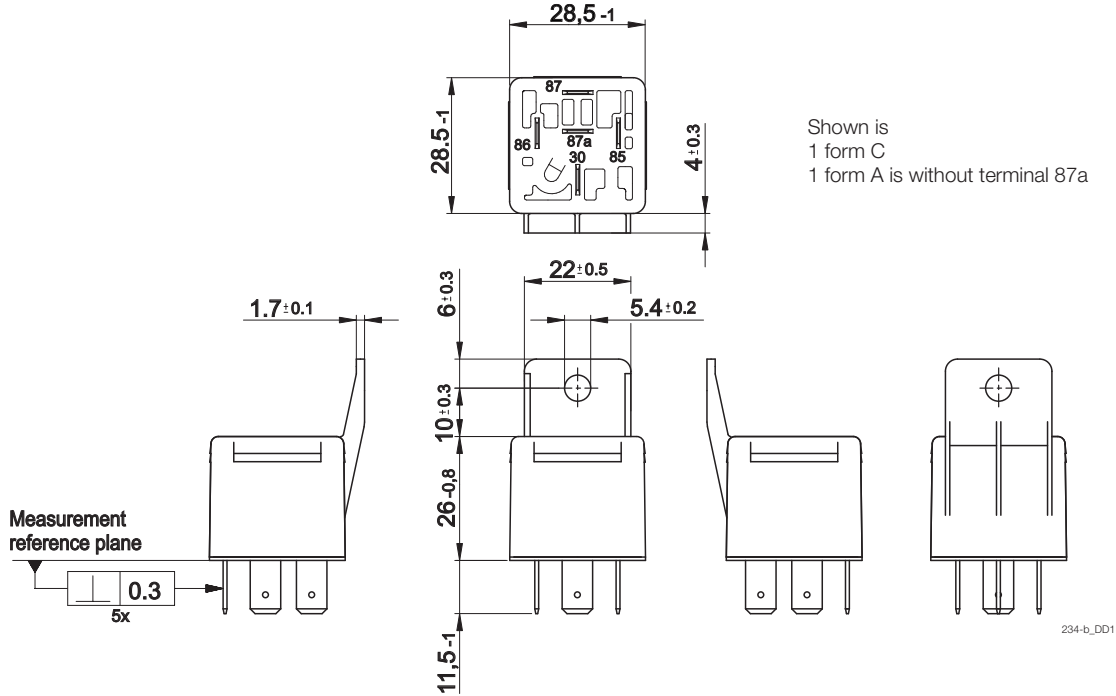

Power Relay B without bracket

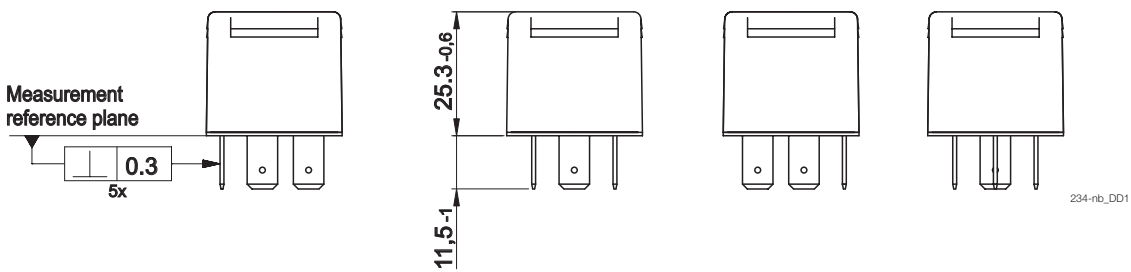

View of the terminals (bottom view)

1 form C  
1 form A is without 87a

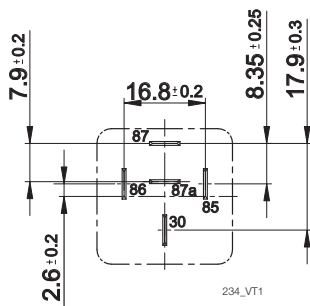

1 form A (2x87)

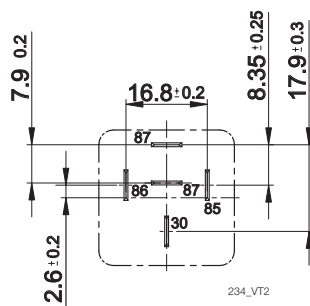

1 form A non ISO  
(Terminals 30 and 86 changed position)

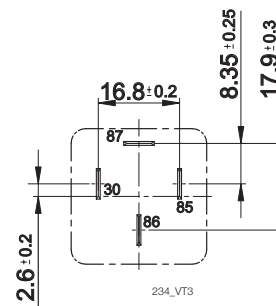

**Power Relay B** (Continued)

**Product code structure**

Typical product code **V23234 -A 0 001 -X040**

<b>Type</b> V23234 Power Relay B	
<b>Contact arrangement</b>	
<b>A</b> 1 form C, 1 CO	<b>B</b> 1 form A, 1 NO
<b>C</b> 1 form A, 1 NO (2x87)	<b>K</b> 1 form A, 1 NO (non ISO)
<b>Cover</b>	
<b>0</b> Standard	<b>1</b> Bracket near terminal 30 ISO
<b>Coil</b>	
<b>001</b> 12VDC	<b>002</b> 12VDC
<b>004</b> 24VDC	
<b>Terminal/arrangement</b>	
<b>Xnnn</b> Customized (nnn: version number)	

Product code	Arrangement	Cover	Coil suppr.	Circuit <sup>1)</sup>	Coil	Contact mat.	Terminals	Part number
V23234-A0001-X032	1 form C, 1 CO	Standard	Resistor 680Ω	COR	12VDC	Silver based	Plug-in, QC	1-1904020-2
V23234-A0001-X038			Diode (cathode 86)	COD				1-1904020-5
V23234-A0001-X040				CO				4-1904020-7
V23234-A0004-X055					24VDC			2-1904025-6
V23234-A0004-X051			Diode (cathode 86)	COD				2-1904025-3
V23234-A0004-X053			Resistor 1400Ω	COR				2-1904025-5
V23234-A1001-X033		Bracket	Resistor 680Ω		12VDC			1-1904022-1
V23234-A1001-X036			CO			3-1904022-2		
V23234-A1001-X041			Diode (cathode 86)	COD				2-1904022-3
V23234-A1004-X050				CO	24VDC			1-1904027-1
V23234-A1004-X054			Resistor 1400Ω	COR				3-1904027-2
V23234-A1004-X094			Diode (cathode 86)	COD				4-1904099-3
V23234-B0001-X001	1 form A, 1 NO	Standard	Resistor 680Ω	NOR	12VDC			5-1904006-1
V23234-B0002-X012			NO			1-1904008-2		
V23234-B1001-X004		Bracket	Resistor 680Ω	NOR				1-1904007-1
V23234-B1001-X010			NO			1-1904007-2		
V23234-C0001-X003	1 form A, 1 NO (2x87)	Standard	Diode (cathode 86)	NOD_2x87				2-1904011-1
V23234-C0001-X006			NO_2x87		2-1904011-2			
V23234-C0004-X018			Resistor 1400Ω	NOR_2x87	24VDC			2-1904015-1
V23234-C0004-X020				NO_2x87				1-1904015-3
V23234-C1001-X005		Bracket			12VDC			5-1904012-1
V23234-C1004-X017			24VDC			5-1904014-1		
V23234-C1004-X085			Resistor 1400Ω	NOR_2x87				1904015-5
V23234-K1001-X024	1 form A, 1 NO		Resistor 680Ω	NOR (non ISO)	12VDC		Plug-in, QC /non ISO	5-1904018-1

1) See terminal assignment diagrams.

Other types on request.

This list represents the most common types and does not show all variants covered by this datasheet.

Компания «Life Electronics» занимается поставками электронных компонентов импортного и отечественного производства от производителей и со складов крупных дистрибьюторов Европы, Америки и Азии.

С конца 2013 года компания активно расширяет линейку поставок компонентов по направлению коаксиальный кабель, кварцевые генераторы и конденсаторы (керамические, пленочные, электролитические), за счёт заключения дистрибьюторских договоров

Мы предлагаем:

- Конкуренспособные цены и скидки постоянным клиентам.
- Специальные условия для постоянных клиентов.
- Подбор аналогов.
- Поставку компонентов в любых объемах, удовлетворяющих вашим потребностям.
- Приемлемые сроки поставки, возможна ускоренная поставка.
- Доставку товара в любую точку России и стран СНГ.
- Комплексную поставку.
- Работу по проектам и поставку образцов.
- Формирование склада под заказчика.
- Сертификаты соответствия на поставляемую продукцию (по желанию клиента).
- Тестирование поставляемой продукции.
- Поставку компонентов, требующих военную и космическую приемку.
- Входной контроль качества.
- Наличие сертификата ISO.

В составе нашей компании организован Конструкторский отдел, призванный помогать разработчикам, и инженерам.

Конструкторский отдел помогает осуществить:

- Регистрацию проекта у производителя компонентов.
- Техническую поддержку проекта.
- Защиту от снятия компонента с производства.
- Оценку стоимости проекта по компонентам.
- Изготовление тестовой платы монтаж и пусконаладочные работы.



Тел: +7 (812) 336 43 04 (многоканальный)

Email: [org@lifeelectronics.ru](mailto:org@lifeelectronics.ru)