

## Description

The 74LVC2G04 is a dual inverter gate with standard push-pull outputs. The device is designed for operation with a power supply range of 1.65V to 5.5V. The inputs are tolerant to 5.5V allowing this device to be used in a mixed voltage environment. The device is fully specified for partial power down applications using I<sub>OFF</sub>. The I<sub>OFF</sub> circuitry disables the output preventing damaging current backflow when the device is powered down.

The gate performs the positive Boolean function:

$$Y = \overline{A}$$

## Pin Assignments

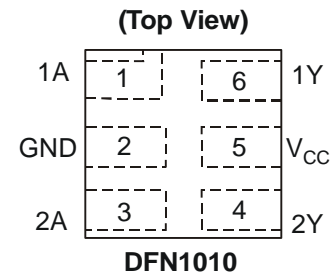
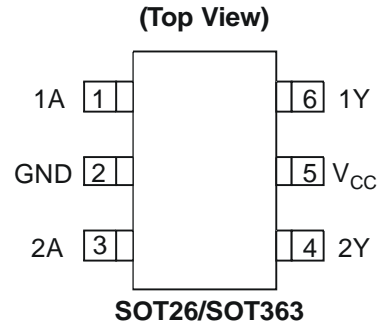

## Features

- Wide Supply Voltage Range from 1.65V to 5.5V
- ±24mA Output Drive at 3.0V
- CMOS low power consumption
- IOFF Supports Partial-Power-Down Mode Operation
- Inputs accept up to 5.5V
- ESD Protection Tested per JESD 22
  - Exceeds 200-V Machine Model (A115-A)
  - Exceeds 2000-V Human Body Model (A114-A)
  - Exceeds 1000-V Charged Device Model (C101)
- Latch-Up Exceeds 100mA per JESD 78, Class II
- Range of Package Options
- SOT26, SOT363, and DFN1010 Available in “Green” Molding Compound (no Br, Sb)
- Lead Free Finish/ RoHS Compliant (Note 1)

## Applications

- Voltage Level Shifting
- General Purpose Logic
- Power Down Signal Isolation
- Wide array of products such as:
  - PCs, networking, notebooks, netbooks, PDAs
  - Computer peripherals, hard drives, CD/DVD ROM
  - TV, DVD, DVR, set top box
  - Cell Phones, Personal Navigation / GPS
  - MP3 players ,Cameras, Video Recorders

Notes: 1. EU Directive 2002/95/EC (RoHS). All applicable RoHS exemptions applied. Please visit our website at [http://www.diodes.com/products/lead\\_free.html](http://www.diodes.com/products/lead_free.html).

**Pin Descriptions**

Pin Name	Pin NO.	Description
1A	1	Data Input
GND	2	Ground
2A	3	Data Input
2Y	4	Data Output
V <sub>CC</sub>	5	Supply Voltage
1Y	6	Data Output

**Logic Diagram**

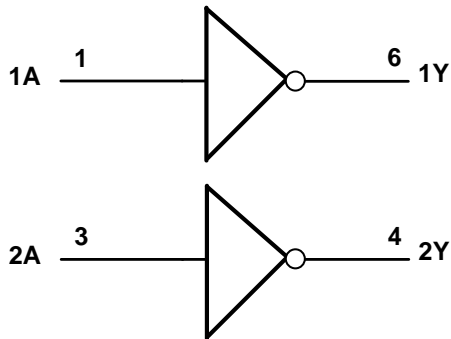

**Function Table**

Inputs	Output
A	Y
H	L
L	H

### Absolute Maximum Ratings (Note 2)

Symbol	Description	Rating	Unit
ESD HBM	ESD Human Body Model ESD Protection	2	KV
ESD CDM	Charged Device Model ESD Protection	1	KV
ESD MM	Machine Model ESD Protection	200	V
$V_{CC}$	Supply Voltage Range	-0.5 to 6.5	V
$V_I$	Input Voltage Range	-0.5 to 6.5	V
$V_O$	Voltage applied to output in high impedance or $I_{OFF}$ state	-0.5 to 6.5	V
$V_O$	Voltage applied to output in high or low state.	-0.3 to $V_{CC} + 0.5$	V
$I_{IK}$	Input Clamp Current $V_I < 0$	-50	mA
$I_{OK}$	Output Clamp Current	-50	mA
$I_O$	Continuous output current	$\pm 50$	mA
	Continuous current through Vdd or GND	$\pm 100$	mA
$T_J$	Operating Junction Temperature	-40 to 150	$^{\circ}C$
$T_{STG}$	Storage Temperature	-65 to 150	$^{\circ}C$

Notes: 2. Stresses beyond the absolute maximum may result in immediate failure or reduced reliability. These are stress values and device operation should be within recommend values.

### Recommended Operating Conditions (Note 3)

Symbol	Parameter		Min	Max	Unit
V <sub>CC</sub>	Operating Voltage	Operating	1.65	5.5	V
		Data retention only	1.5		V
V <sub>IH</sub>	High-level Input Voltage	V <sub>CC</sub> = 1.65V to 1.95V	0.65 X V <sub>CC</sub>		V
		V <sub>CC</sub> = 2.3V to 2.7V	1.7		
		V <sub>CC</sub> = 3V to 3.6V	2		
		V <sub>CC</sub> = 4.5V to 5.5V	0.7 X V <sub>CC</sub>		
V <sub>IL</sub>	Low-level input voltage	V <sub>CC</sub> = 1.65V to 1.95V		0.35 X V <sub>CC</sub>	V
		V <sub>CC</sub> = 2.3V to 2.7V		0.7	
		V <sub>CC</sub> = 3V to 3.6V		0.8	
		V <sub>CC</sub> = 4.5V to 5.5V		0.3 X V <sub>CC</sub>	
V <sub>I</sub>	Input Voltage		0	5.5	V
V <sub>O</sub>	Output Voltage		0	V <sub>CC</sub>	V
I <sub>OH</sub>	High-level output current	V <sub>CC</sub> = 1.65V		-4	mA
		V <sub>CC</sub> = 2.3V		-8	
		V <sub>CC</sub> = 3V		-16	
		V <sub>CC</sub> = 4.5V		-24	
I <sub>OL</sub>	Low-level output current	V <sub>CC</sub> = 1.65V		4	mA
		V <sub>CC</sub> = 2.3V		8	
		V <sub>CC</sub> = 3V		16	
		V <sub>CC</sub> = 4.5V		24	
Δt/ΔV	Input transition rise or fall rate	V <sub>CC</sub> = 1.8V ± 0.15V, 2.5V ± 0.2V		20	ns/V
		V <sub>CC</sub> = 3.3V ± 0.3V		10	
		V <sub>CC</sub> = 5V ± 0.5V		5	
T <sub>A</sub>	Operating free-air temperature		-40	125	°C

Notes: 3. Unused inputs should be held at V<sub>CC</sub> or Ground.

### Electrical Characteristics

Symbol	Parameter	Test Conditions	V <sub>CC</sub>	40°C to 85°C		-40°C to 125°C		Unit	
				Min	Max	Min	Max		
V <sub>OH</sub>	High Level Output Voltage	I <sub>OH</sub> = -100μA	1.65V to 5.5V	V <sub>CC</sub> - 0.1		V <sub>CC</sub> - 0.1		V	
		I <sub>OH</sub> = -4mA	1.65V	1.2		0.95			
		I <sub>OH</sub> = -8mA	2.3V	1.9		1.7			
		I <sub>OH</sub> = -16mA	3V	2.4		1.9			
		I <sub>OH</sub> = -24mA		2.3		2.0			
		I <sub>OH</sub> = -32mA	4.5V	3.8		3.4			
V <sub>OL</sub>	Low Level Output Voltage	I <sub>OL</sub> = 100μA	1.65V to 5.5V		0.1		0.1	V	
		I <sub>OL</sub> = 4mA	1.65V		0.45		0.70		
		I <sub>OL</sub> = 8mA	2.3V		0.3		0.45		
		I <sub>OL</sub> = 16mA	3V			0.4			0.60
		I <sub>OL</sub> = 24mA				0.55			0.80
		I <sub>OL</sub> = 32mA	4.5V		0.55		0.80		
I <sub>I</sub>	Input Current	V <sub>I</sub> = 5.5 V or GND	0 to 5.5V		± 5		± 20	μA	
I <sub>OFF</sub>	Power Down Leakage Current	V <sub>I</sub> or V <sub>O</sub> = 5.5V	0		± 10		± 20	μA	
I <sub>CC</sub>	Supply Current	V <sub>I</sub> = 5.5V of GND I <sub>O</sub> =0	1.65V to 5.5V		10		40	μA	
ΔI <sub>CC</sub>	Additional Supply Current	Input at V <sub>CC</sub> - 0.6V	3 V to 5.5V		500		5000	μA	

### Package Characteristics (All typical values are at V<sub>CC</sub> = 3.3V, T<sub>A</sub> = 25°C)

Symbol	Parameter	Test Conditions	V <sub>CC</sub>	Min	Typ.	Max	Unit
C <sub>I</sub>	Input Capacitance	V <sub>I</sub> = V <sub>CC</sub> - or GND	3.3		4		pF
θ <sub>JA</sub>	Thermal Resistance Junction-to-Ambient	SOT26	(Note 4)		204		°C/W
		SOT363			371		
		DFN1010			430		
θ <sub>JC</sub>	Thermal Resistance Junction-to-Case	SOT26	(Note 4)		52		°C/W
		SOT363			143		
		DFN1010			190		

Notes: 4. Test condition for SOT26, SOT363 and DFN1010: Device mounted on FR-4 substrate PC board, 2oz copper, with minimum recommended pad layout.

### Switching Characteristics

$T_A = -40^{\circ}\text{C}$  to  $85^{\circ}\text{C}$ ,  $C_L = 30$  or  $50\text{pF}$  (see Figure 1)

Parameter	From (Input)	TO (OUTPUT)	$V_{CC} = 1.8\text{V} \pm 0.15\text{V}$		$V_{CC} = 2.5\text{V} \pm 0.2\text{V}$		$V_{CC} = 3.3\text{V} \pm 0.3\text{V}$		$V_{CC} = 5\text{V} \pm 0.5\text{V}$		Unit
			Min	Max	Min	Max	Min	Max	Min	Max	
$t_{pd}$	A	Y	0.5	8.0	1.0	4.4	0.5	4.1	0.5	3.2	ns

$T_A = -40^{\circ}\text{C}$  to  $125^{\circ}\text{C}$ ,  $C_L = 30$  or  $50\text{pF}$  (see Figure 1)

Parameter	From (Input)	TO (OUTPUT)	$V_{CC} = 1.8\text{V} \pm 0.15\text{V}$		$V_{CC} = 2.5\text{V} \pm 0.2\text{V}$		$V_{CC} = 3.3\text{V} \pm 0.3\text{V}$		$V_{CC} = 5\text{V} \pm 0.5\text{V}$		Unit
			Min	Max	Min	Max	Min	Max	Min	Max	
$t_{pd}$	A	Y	0.5	9.5	0.5	5.4	0.5	5.5	0.5	3.8	ns

### Operating Characteristics

$T_A = 25^{\circ}\text{C}$

Parameter		Test Conditions	$V_{CC} = 1.8\text{V}$	$V_{CC} = 2.5\text{V}$	$V_{CC} = 3.3\text{V}$	$V_{CC} = 5\text{V}$	Unit
			Typ.	Typ.	Typ.	Typ.	
$C_{pd}$	Power dissipation capacitance	$f = 10\text{MHz}$	17	19	20	21	pF

**Parameter Measurement Information**

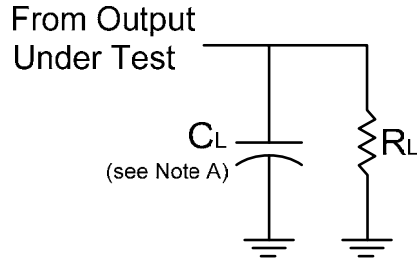

V <sub>CC</sub>	Inputs		V <sub>M</sub>	C <sub>L</sub>	R <sub>L</sub>
	V <sub>I</sub>	t <sub>r</sub> /t <sub>f</sub>			
1.8V±0.15V	V <sub>CC</sub>	≤2ns	V <sub>CC</sub> /2	30 pF	1 KΩ
2.5V±0.2V	V <sub>CC</sub>	≤2ns	V <sub>CC</sub> /2	30 pF	500 Ω
3.3V±0.3V	3V	≤2.5ns	1.5 V	50 pF	500 Ω
5V±0.5V	V <sub>CC</sub>	≤2.5ns	V <sub>CC</sub> /2	50 pF	500 Ω

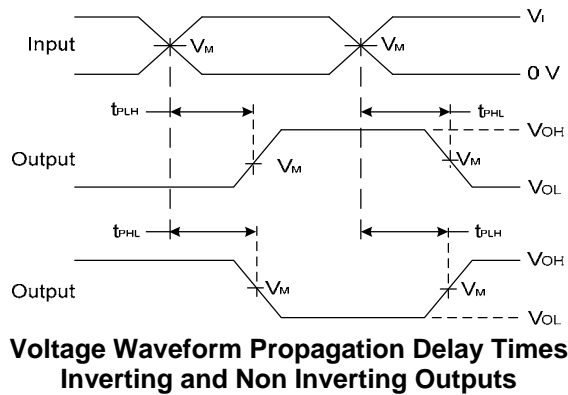
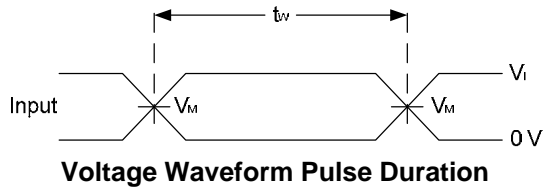
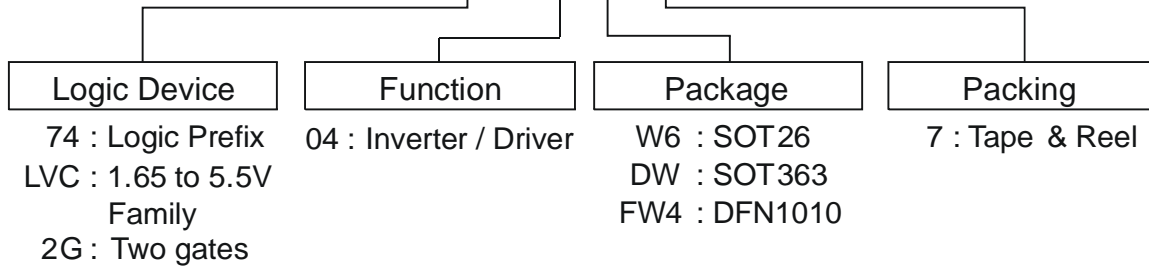

**Figure 1. Load Circuit and Voltage Waveforms**

- Notes:
- A. Includes test lead and test apparatus capacitance.
  - B. All pulses are supplied at pulse repetition rate ≤ 10 MHz.
  - C. Inputs are measured separately one transition per measurement.
  - D. t<sub>PLH</sub> and t<sub>PHL</sub> are the same as t<sub>PD</sub>.

**Ordering Information**

**74LVC2G 04 XX - 7**



Device	Package Code	Packaging (Note 5)	7" Tape and Reel	
			Quantity	Part Number Suffix
74LVC2G04W6-7	W6	SOT26	3000/Tape & Reel	-7
74LVC2G04DW-7	DW	SOT363	3000/Tape & Reel	-7
74LVC2G04FW4-7	FW4	DFN1010	5000/Tape & Reel	-7



- Notes:
5. Pad layout as shown on Diodes Inc. suggested pad layout document AP02001, which can be found on our website at <http://www.diodes.com/datasheets/ap02001.pdf>.
  6. The taping orientation is located on our website at <http://www.diodes.com/datasheets/ap02007.pdf>

NEW PRODUCT



**Marking Information**

(1) SOT26, SOT363

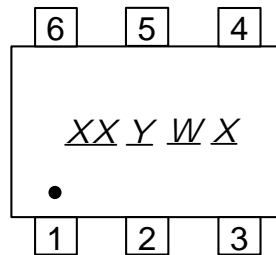

XX : Identification code  
Y : Year 0~9  
W : Week : A~Z : 1~26 week;  
a~z : 27~52 week; z represents  
52 and 53 week  
X : A~Z : Internal Code

Part Number	Package	Identification Code
74LVC2G04W6	SOT26	Z2
74LVC2G04DW	SOT363	Z2

(2) DFN1010

(Top View)

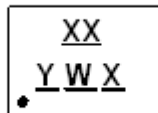

XX : Identification Code  
Y : Year : 0~9  
W : Week : A~Z : 1~26 week;  
a~z : 27~52 week; z represents  
52 and 53 week  
X : A~Z : Internal code

Part Number	Package	Identification Code
74LVC2G04FW4	DFN1010	Z2

**Package Outline Dimensions (All Dimensions in mm)**

**(1) Package Type: SOT26**

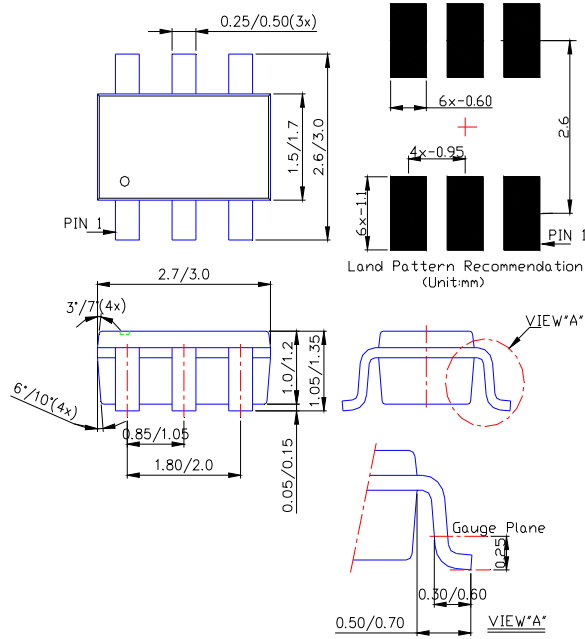

**(2) Package Type: SOT363**

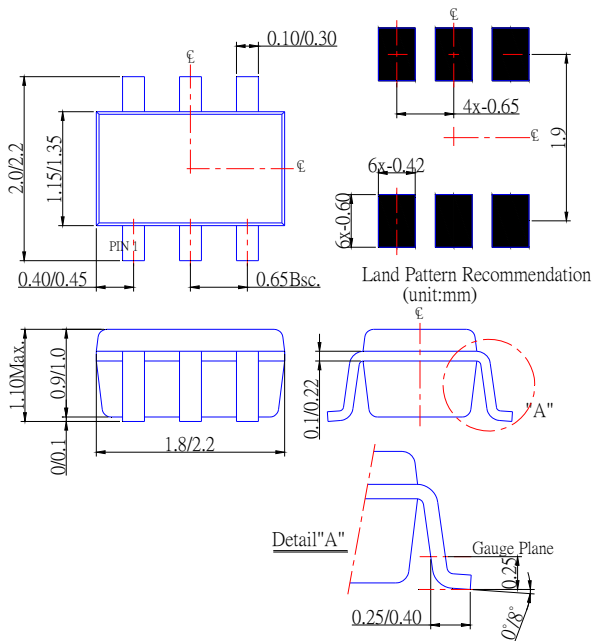



**IMPORTANT NOTICE**

DIODES INCORPORATED MAKES NO WARRANTY OF ANY KIND, EXPRESS OR IMPLIED, WITH REGARDS TO THIS DOCUMENT, INCLUDING, BUT NOT LIMITED TO, THE IMPLIED WARRANTIES OF MERCHANTABILITY AND FITNESS FOR A PARTICULAR PURPOSE (AND THEIR EQUIVALENTS UNDER THE LAWS OF ANY JURISDICTION).

Diodes Incorporated and its subsidiaries reserve the right to make modifications, enhancements, improvements, corrections or other changes without further notice to this document and any product described herein. Diodes Incorporated does not assume any liability arising out of the application or use of this document or any product described herein; neither does Diodes Incorporated convey any license under its patent or trademark rights, nor the rights of others. Any Customer or user of this document or products described herein in such applications shall assume all risks of such use and will agree to hold Diodes Incorporated and all the companies whose products are represented on Diodes Incorporated website, harmless against all damages.

Diodes Incorporated does not warrant or accept any liability whatsoever in respect of any products purchased through unauthorized sales channel.

Should Customers purchase or use Diodes Incorporated products for any unintended or unauthorized application, Customers shall indemnify and hold Diodes Incorporated and its representatives harmless against all claims, damages, expenses, and attorney fees arising out of, directly or indirectly, any claim of personal injury or death associated with such unintended or unauthorized application.

Products described herein may be covered by one or more United States, international or foreign patents pending. Product names and markings noted herein may also be covered by one or more United States, international or foreign trademarks.

**LIFE SUPPORT**

Diodes Incorporated products are specifically not authorized for use as critical components in life support devices or systems without the express written approval of the Chief Executive Officer of Diodes Incorporated. As used herein:

A. Life support devices or systems are devices or systems which:

1. are intended to implant into the body, or
2. support or sustain life and whose failure to perform when properly used in accordance with instructions for use provided in the labeling can be reasonably expected to result in significant injury to the user.

B. A critical component is any component in a life support device or system whose failure to perform can be reasonably expected to cause the failure of the life support device or to affect its safety or effectiveness.

Customers represent that they have all necessary expertise in the safety and regulatory ramifications of their life support devices or systems, and acknowledge and agree that they are solely responsible for all legal, regulatory and safety-related requirements concerning their products and any use of Diodes Incorporated products in such safety-critical, life support devices or systems, notwithstanding any devices- or systems-related information or support that may be provided by Diodes Incorporated. Further, Customers must fully indemnify Diodes Incorporated and its representatives against any damages arising out of the use of Diodes Incorporated products in such safety-critical, life support devices or systems.

Copyright © 2011, Diodes Incorporated

[www.diodes.com](http://www.diodes.com)

Компания «Life Electronics» занимается поставками электронных компонентов импортного и отечественного производства от производителей и со складов крупных дистрибьюторов Европы, Америки и Азии.

С конца 2013 года компания активно расширяет линейку поставок компонентов по направлению коаксиальный кабель, кварцевые генераторы и конденсаторы (керамические, пленочные, электролитические), за счёт заключения дистрибьюторских договоров

Мы предлагаем:

- Конкуренеспособные цены и скидки постоянным клиентам.
- Специальные условия для постоянных клиентов.
- Подбор аналогов.
- Поставку компонентов в любых объемах, удовлетворяющих вашим потребностям.
- Приемлемые сроки поставки, возможна ускоренная поставка.
- Доставку товара в любую точку России и стран СНГ.
- Комплексную поставку.
- Работу по проектам и поставку образцов.
- Формирование склада под заказчика.
- Сертификаты соответствия на поставляемую продукцию (по желанию клиента).
- Тестирование поставляемой продукции.
- Поставку компонентов, требующих военную и космическую приемку.
- Входной контроль качества.
- Наличие сертификата ISO.

В составе нашей компании организован Конструкторский отдел, призванный помогать разработчикам, и инженерам.

Конструкторский отдел помогает осуществить:

- Регистрацию проекта у производителя компонентов.
- Техническую поддержку проекта.
- Защиту от снятия компонента с производства.
- Оценку стоимости проекта по компонентам.
- Изготовление тестовой платы монтаж и пусконаладочные работы.



Тел: +7 (812) 336 43 04 (многоканальный)  
Email: [org@lifeelectronics.ru](mailto:org@lifeelectronics.ru)