

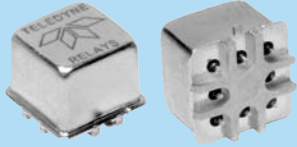

A Unit of Teledyne Electronics and Communications



# SERIES GRF172

## SURFACE MOUNT, CENTIGRID® 2.5 GHz RF RELAYS DPDT

SERIES DESIGNATION	RELAY TYPE
GRF172	Surface mount, RF Centigrd® relay
GRF172D	Surface mount, RF Centigrd® relay with coil transient suppresson diode

### INTERNAL CONSTRUCTION

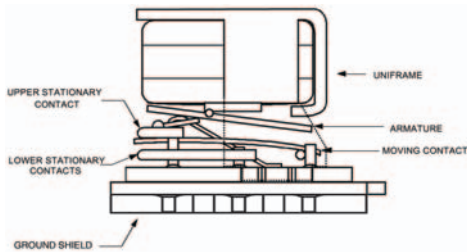

### DESCRIPTION

The GRF172 surface-mount Centigrd® relay is an ultraminiature, hermetically sealed, armature relay for 2.5 GHz RF applications. Its low profile height (.330") and .100" grid spaced terminals make it an ideal choice where extreme packaging density and/or close PC board spacing are required.

The GRF172 features a unique ground shield that isolates and shields each lead to ensure excellent contact-to-contact and pole-to-pole isolation. This ground shield provides a ground interface that results in improved high-frequency performance as well as parametric repeatability. The GRF172 extends performance advantages over similar RF devices that simply offer formed leads for surface mounting.

Unique construction features and manufacturing techniques provide overall high reliability and excellent resistance to environmental extremes:

- All welded construction.
- Unique uni-frame design providing high magnetic efficiency and mechanical rigidity.
- High force/mass ratios for resistance to shock and vibration.
- Advanced cleaning techniques provide maximum assurance of internal cleanliness.
- Precious metal alloy contact material with gold plating assures excellent high current and dry circuit switching capabilities.

The Series GRF172D has an internal discrete silicon diode for coil transient suppression.

Applications include telecommunications, test instruments, mobile communications, attenuators, and automatic test equipment.

ENVIRONMENTAL AND PHYSICAL SPECIFICATIONS		
Temperature (Ambient)	Storage	-65°C to +125°C
	Operating	-55°C to +85°C
Vibration (General Note 1)		10 g's to 500 Hz
Shock (General Note 1)		30 g's, 6 msec, half-sine
Enclosure		Hermetically sealed
Weight		0.09 oz. (2.55g) max.

**SERIES GRF172**  
**TYPICAL RF CHARACTERISTICS (See RF Notes)**

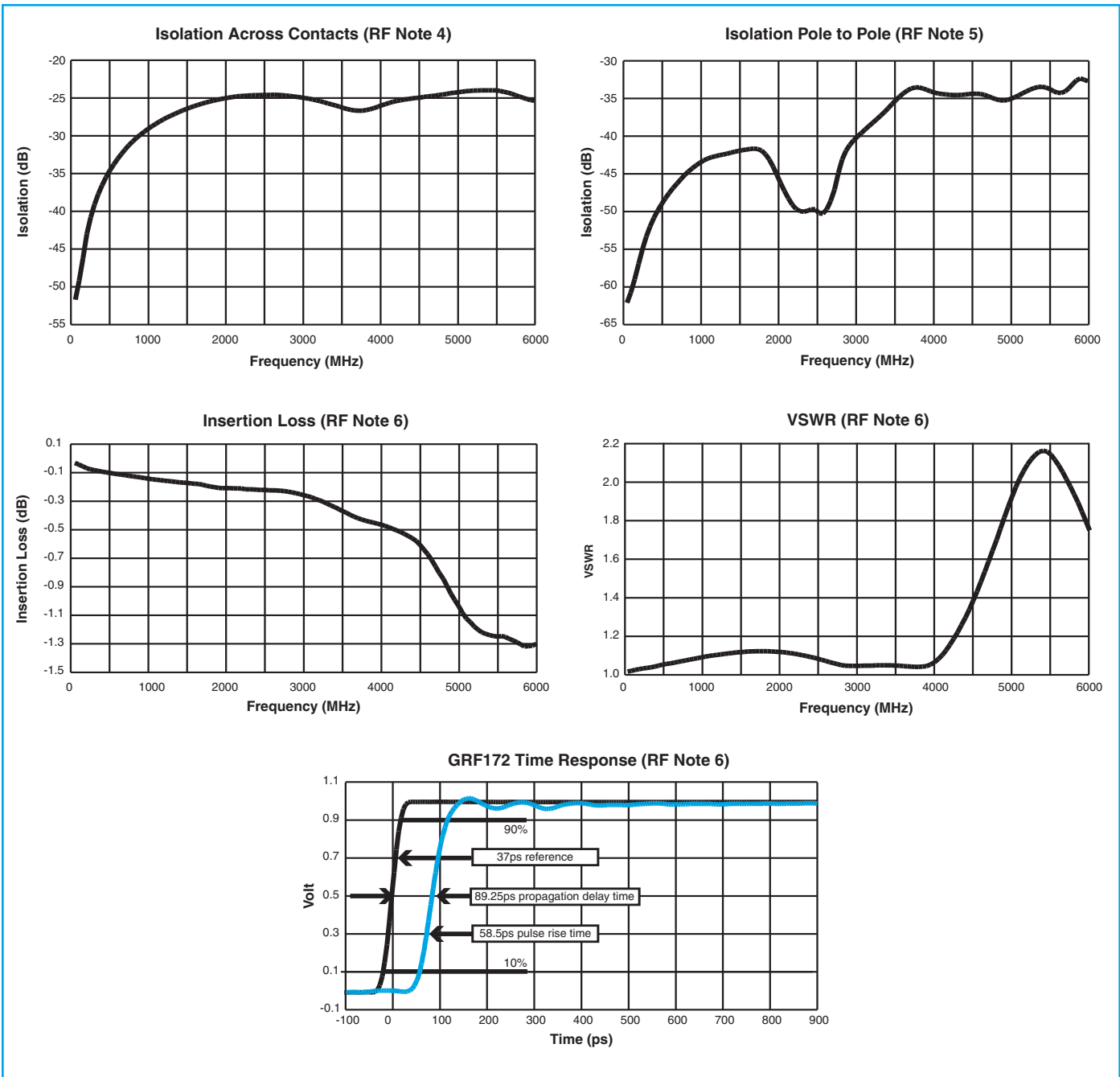

**RF NOTES**

1. Test conditions:
  - a. Fixture: .031" copper clad, reinforced PTFE, RT/duroid® 6002 with SMA connectors. (RT/duroid® is a registered trademark of Rogers Corporation.)
  - b. RF ground shield is soldered to PCB RF ground plane.
  - c. Room ambient temperature.
  - d. Terminals not tested were terminated with 50-ohm load.
  - e. Contact signal level: -10 dBm.
  - f. No. of test samples: 2.
2. Data presented herein represents typical characteristics and is not intended for use as specification limits.
3. Data is per pole, except for pole-to-pole data.
4. Data is the average from readings taken on all open contacts.
5. Data is the average from readings taken on poles with coil energized and de-energized.
6. Data is the average from readings taken on all closed contacts.
7. Test fixture effect de-embedded from frequency and time response data.

## SERIES GRF172

### TYPICAL RF INSERTION LOSS REPEATABILITY CHARACTERISTICS (See RF Insertion Loss Repeatability Notes)

#### REPEATABILITY CHARACTERISTICS GRF172 RELAYS

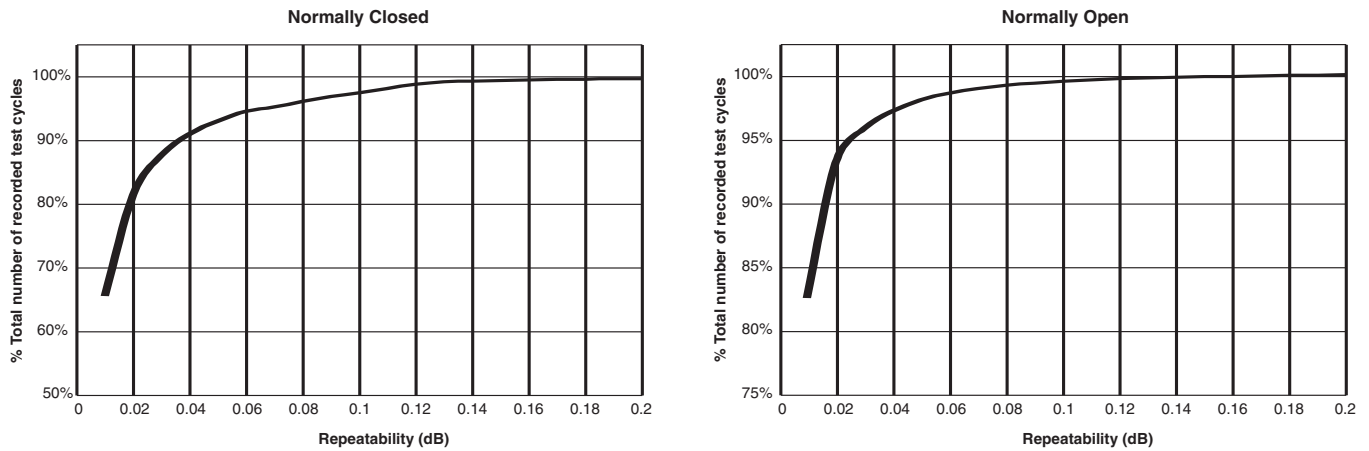

#### RF INSERTION LOSS REPEATABILITY NOTES

1. Test conditions:
  - a. Fixture: .031" copper clad, reinforced PTFE, RT/duroid® 6002 with SMA connectors. (RT/duroid® is a registered trademark of Rogers Corporation.)
  - b. Test performed at room ambient temperature.
  - c. Contact signal level: -10 dBm.
2. Data presented herein represents typical characteristics and is not intended for use as specification limits.
3. Insertion loss repeatability measured over frequency range from 50 MHz to 4 GHz.

**SERIES GRF172**  
**GENERAL ELECTRICAL SPECIFICATIONS (@25°C Notes 2 & 5)**

<b>Contact Arrangement</b>	2 Form C (DPDT)
<b>Rated Duty</b>	Continuous
<b>Contact Resistance</b>	0.15 ohm max. before life; 0.3 ohm max. after life at 1A/28Vdc (measured 1/8" from header)
<b>Contact Load Rating (DC)</b> (See Fig. 1 for other DC resistive voltage/current ratings)	Resistive: 1 Amp/28Vdc Inductive: 100 mA/28Vdc (320 mH) Lamp: 100 mA/28Vdc Low Level: 10 to 50 $\mu$ A/10 to 50mV
<b>Contact Life Ratings</b>	5,000,000 cycles (typical) at low level 500,000 cycles (typical) at 0.5A/28Vdc resistive 100,000 cycles min. at all other loads specified above
<b>Contact Overload Rating</b>	2A/28Vdc Resistive (100 cycles min.)
<b>Contact Carry Rating</b>	Contact factory
<b>Operate Time</b>	6.0 msec max. at nominal rated coil voltage
<b>Release Time</b>	GRF172: 3.0 msec max. GRF172D: 6.0 msec max.
<b>Intercontact Capacitance</b>	0.4 pf typical
<b>Insulation Resistance</b>	1,000 megohms min. between mutually isolated terminals
<b>Dielectric Strength</b>	Atmospheric pressure: 350 Vrms/60Hz
<b>Negative Coil Transient GRF172</b>	2.0 Vdc Max.
<b>Diode P.I.V. GRF172D</b>	60 Vdc Min.

**DETAILED ELECTRICAL SPECIFICATIONS (@25°C Note 2)**

	BASE PART NUMBERS	GRF172-5 GRF172D-5	GRF172-12 GRF172D-12	GRF172-26 GRF172D-26
	<b>Coil Voltage, Nominal (Vdc)</b>	Nom.	5.0	12.0
	Max.	5.8	16.0	32.0
<b>Coil Resistance (Ohms <math>\pm</math>20%)</b>		64	400	1600
<b>Pick-up Voltage (Vdc, Max.)</b>		3.8	9.0	18.0
<b>Coil Operating Power at Nominal Voltage (Milliwatts)</b>		405	360	440

**GENERAL NOTES**

1. Relays will exhibit no contact chatter in excess of 10  $\mu$ sec or transfer in excess of 1  $\mu$ sec.
2. Unless otherwise specified, parameters are initial values.
3. Relays may be subjected to 260°C, peak solder reflow temperature, 1 minute, 3 passes.
4. Butt-lead ends are coplanar within .003" (0.08).
5. "Typical" characteristics are based on available data and are best estimates. No on-going verification tests are performed.
6. Application notes available for PCB layout and mounting information.

**OUTLINE DIMENSIONS**

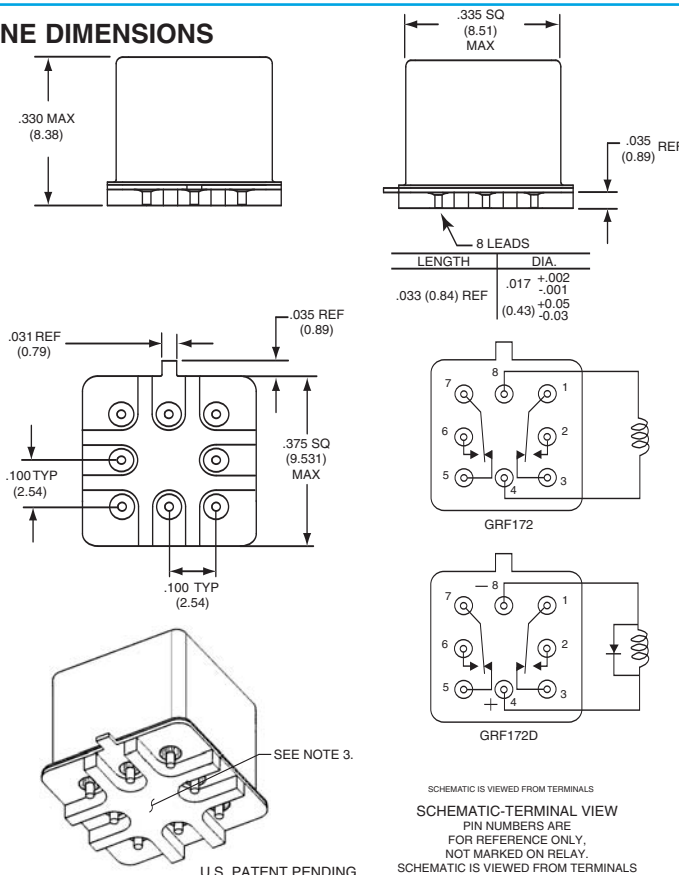

NOTES:  
 1. DIMENSIONS ARE IN INCHES. METRIC EQUIVALENTS IN MILLIMETERS ARE SHOWN IN ( ).  
 2. UNLESS OTHERWISE SPECIFIED, TOLERANCES ON DIMENSIONS ARE  $\pm$ .010 INCH (0.025 mm).  
 3. FOR OPTIMAL RF PERFORMANCE, SOLDER BOTTOM OF GROUND SHIELD TO PCB RF GROUND PLANE.

# Appendix A: Spacer Pads

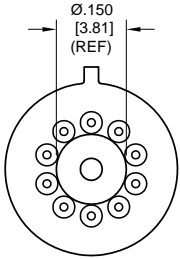
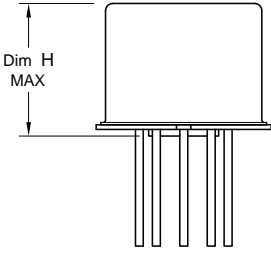
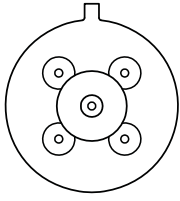
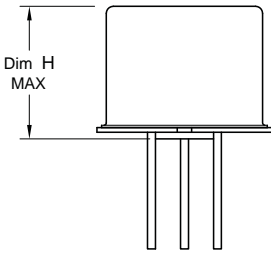
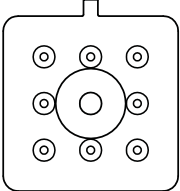
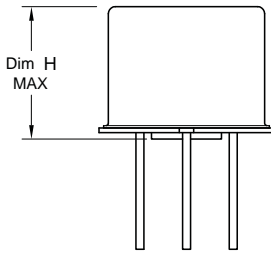
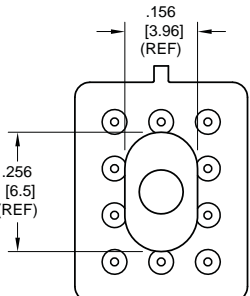
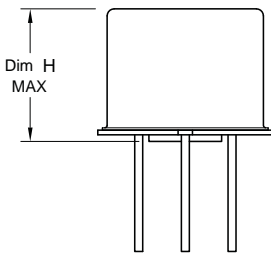
Pad designation and bottom view dimensions	Height	For use with the following:	Dim. H Max.
 <p style="text-align: center;">“M4” Pad for TO-5</p>		ER411T ER412, ER412D, ER412DD	.295 (7.49)
		712, 712D, 712TN, RF300, RF310, RF320	.300 (7.62)
		ER420, ER422D, ER420DD, 421, ER421D, ER421DD, ER422, ER422D, ER422DD, 722, 722D, RF341	.305 (7.75)
		ER431T, ER432T, ER432, ER432D, ER432DD	.400 (10.16)
		732, 732D, 732TN, RF303, RF313, RF323	.410 (10.41)
		RF312	.350 (8.89)
 <p style="text-align: center;">“M4” Pad for TO-5</p>		ER411, ER411D, ER411DD	.295 (7.49)
		ER431, ER431D, ER431DD	.400 (10.16)
		RF311	.300 (7.62)
		RF331	.410 (10.41)
 <p style="text-align: center;">“M4” Pad for Centigrid®</p>		172, 172D	.305 (7.75)
		ER114, ER114D, ER114DD, J114, J114D, J114DD	.300 (7.62)
		ER134, ER134D, ER134DD, J134, J134D, J134DD	.400 (10.16)
		RF100	.315 (8.00)
		RF103	.420 (10.67)
 <p style="text-align: center;">“M9” Pad for Centigrid®</p>		122C, A152	.320 (8.13)
		ER116C, J116C	.300 (7.62)
		ER136C, J136C	.400 (10.16)
		RF180	.325 (8.25)
		A150	.305 (7.75)

**Notes:**

1. Spacer pad material: Polyester film.
2. To specify an “M4” or “M9” spacer pad, refer to the mounting variants portion of the part numbering example in the applicable datasheet.
3. Dimensions are in inches (mm).
4. Unless otherwise specified, tolerance is  $\pm .010$  (.25).
5. Add 10 m $\Omega$  to the contact resistance show in the datasheet.
6. Add 0.01 oz. (0.25 g) to the weight of the relay assembly shown in the datasheet.

# Appendix A: Spreader Pads

Pad designation and bottom view dimensions	Height	For use with the following:	Dim. H Max.
<p style="text-align: center;">“M” Pad <u>5/</u> <u>6/</u></p>		ER411T, J411T, ER412, ER412D ER412DD, J412, J412D, J412DD ER412T, J412T	.388 (9.86)
		712, 712D, 712TN	.393 (9.99)
		ER431T, J431T, ER432, ER432D ER432DD, J432, J432D, J432DD ER432T, J432T	.493 (12.52)
		732, 732D, 732TN	.503 (12.78)
		ER420, J420, ER420D, J420D ER420DD, J420DD, ER421, J421 ER421D, J421D, ER421DD J422D, ER422DD, J422DD, 722	.398 (10.11)
<p style="text-align: center;">“M4” Pad <u>7/</u> <u>8/</u></p>		ER411T ER412, ER412D, ER412DD J412, J412D, J412DD	.441 (11.20)
		712, 712D	.451 (11.46)
		ER421, ER421D, ER421DD 722, 732D	.451 (11.46)
		ER431T ER432, ER432D, ER432DD	.546 (13.87)
		732, 732D	.556 (14.12)
<p style="text-align: center;">“M5” Pad <u>5/</u> <u>6/</u> <u>9/</u></p>		ER411, ER411D, ER411DD ER411TX ER412X, ER412DX, ER412DDX ER412TX	.388 (9.86)
		712X, 712DX, 712TNX	.393 (9.99)
		ER420X, ER420DX, ER420DDX ER421X, ER421DX, ER421DDX ER422X, ER422DX ER422DDX, 722X, 722DDX	.398 (10.11)
		ER431, ER431D, ER431DD ER431TX ER432X, ER432DX, ER432DDX ER432TX	.493 (12.52)
		732X, 732DX, 732TNX	.503 (12.78)

**Notes:**

1. Spreader pad material: Diallyl Phthalate.
2. To specify an “M”, “M2” or “M3” spreader pad, refer to the mounting variants portion of the part number example in the applicable datasheet.
3. Dimensions are in inches (mm).
4. Unless otherwise specified, tolerance is  $\pm .010$ ” (0.25).
- 5/. Add 25 mΩ to the contact resistance shown in the datasheet.
- 6/. Add .01 oz. (0.25 g) to the weight of the relay assembly shown in the datasheet.
- 7/. Add 50 mΩ to the contact resistance shown in the datasheet.
- 8/. Add 0.025 oz (0.71 g) to the weight of the relay assembly shown in the datasheet.
- 9/. M3 pad to be used only when the relay has a center pin (e.g. ER411M3-12A, 722XM3-26.)

# Appendix A: Ground Pin Positions

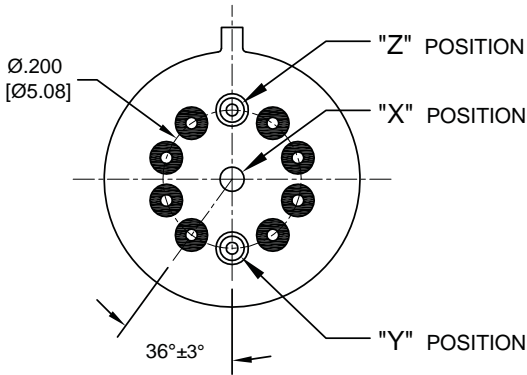

### TO-5 Relays:

ER411T, ER412, ER412T, ER420, ER421, ER422,  
ER431T, ER432, ER432T, 712, 712TN, 400H, 400K,  
400V, RF300, RF303, RF341, RF312, RF310, RF313,  
RF320, RF323

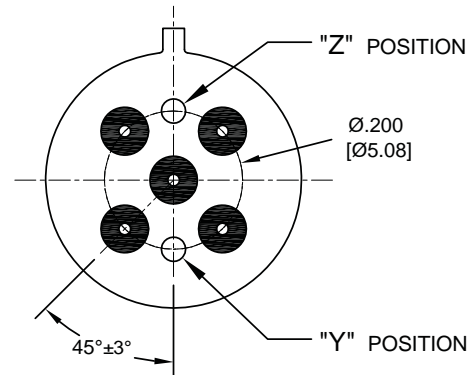

### TO-5 Relays:

ER411, ER431, RF311, RF331

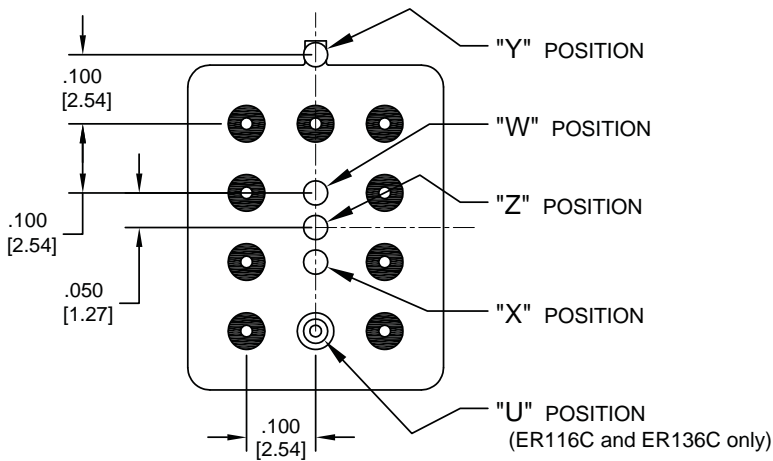

### Centigrid® Relays:

RF180, ER116C, 122C, ER136C

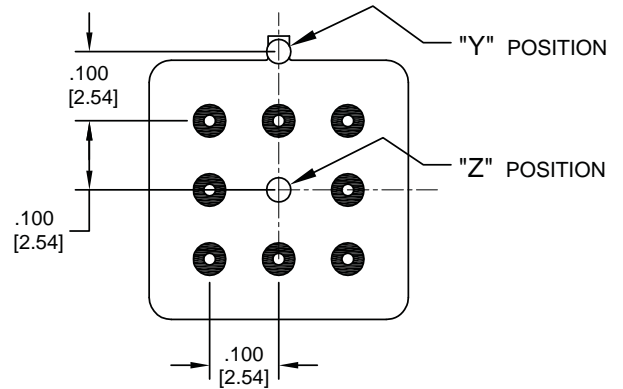

### Centigrid® Relays:

RF100, RF103, ER114, ER134, 172

- Indicates ground pin position
- Indicates glass insulated lead position
- ◎ Indicates ground pin or lead position depending on relay type

### NOTES

1. Terminal views shown
2. Dimensions are in inches (mm)
3. Tolerances: ± .010 (±.25) unless otherwise specified
4. Ground pin positions are within .015 (0.38) dia. of true position
5. Ground pin head dia., 0.035 (0.89) ref: height 0.010 (0.25) ref.
6. Lead dia. 0.017 (0.43) nom.



Компания «Life Electronics» занимается поставками электронных компонентов импортного и отечественного производства от производителей и со складов крупных дистрибьюторов Европы, Америки и Азии.

С конца 2013 года компания активно расширяет линейку поставок компонентов по направлению коаксиальный кабель, кварцевые генераторы и конденсаторы (керамические, пленочные, электролитические), за счёт заключения дистрибьюторских договоров

Мы предлагаем:

- Конкуренспособные цены и скидки постоянным клиентам.
- Специальные условия для постоянных клиентов.
- Подбор аналогов.
- Поставку компонентов в любых объемах, удовлетворяющих вашим потребностям.
- Приемлемые сроки поставки, возможна ускоренная поставка.
- Доставку товара в любую точку России и стран СНГ.
- Комплексную поставку.
- Работу по проектам и поставку образцов.
- Формирование склада под заказчика.
- Сертификаты соответствия на поставляемую продукцию (по желанию клиента).
- Тестирование поставляемой продукции.
- Поставку компонентов, требующих военную и космическую приемку.
- Входной контроль качества.
- Наличие сертификата ISO.

В составе нашей компании организован Конструкторский отдел, призванный помогать разработчикам, и инженерам.

Конструкторский отдел помогает осуществить:

- Регистрацию проекта у производителя компонентов.
- Техническую поддержку проекта.
- Защиту от снятия компонента с производства.
- Оценку стоимости проекта по компонентам.
- Изготовление тестовой платы монтаж и пусконаладочные работы.



Тел: +7 (812) 336 43 04 (многоканальный)

Email: [org@lifeelectronics.ru](mailto:org@lifeelectronics.ru)