

Typical Applications

The HMC570LC5 is ideal for:

- Point-to-Point and Point-to-Multi-Point Radio
- Military Radar, EW & ELINT
- Satellite Communications

Features

- 10 dB Conversion Gain
- Image Rejection: 18 dB
- 2 LO to RF Isolation: 65 dB
- Noise Figure: 3 dB
- Input IP3: +2 dBm
- 32 Lead 5x5mm SMT Package: 25mm²

Functional Diagram

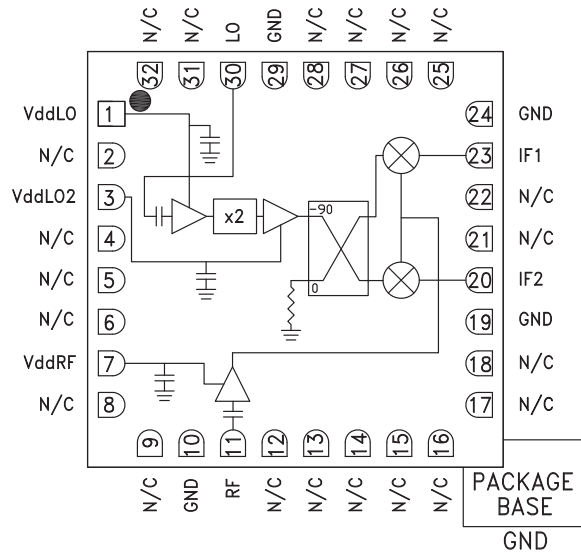

General Description

The HMC570LC5 is a compact GaAs MMIC I/Q downconverter in a leadless RoHS compliant SMT package. This device provides a small signal conversion gain of 10 dB with a noise figure of 3 dB and 18 dB of image rejection across the frequency band. The HMC570LC5 utilizes an LNA followed by an image reject mixer which is driven by an active x2 multiplier. The image reject mixer eliminates the need for a filter following the LNA, and removes thermal noise at the image frequency. I and Q mixer outputs are provided and an external 90° hybrid is needed to select the required sideband. The HMC570LC5 is a much smaller alternative to hybrid style image reject mixer downconverter assemblies, and it eliminates the need for wire bonding by allowing the use of surface mount manufacturing techniques.

Electrical Specifications, $T_A = +25^\circ C$, $IF = 100 MHz$, $LO = +4 dBm$, $Vdd = 3.5 Vdc^*$

Parameter	Min.	Typ.	Max.	Min.	Typ.	Max.	Units
Frequency Range, RF		17.7 - 19.7		17 - 21			GHz
Frequency Range, LO		7 - 12		7 - 12			GHz
Frequency Range, IF		DC - 3.5		DC - 3.5			GHz
Conversion Gain (As IRM)	9	10		8	10		dB
Noise Figure		3			3		dB
Image Rejection	14	17		14	22		dB
1 dB Compression (Input)	-5	-4		-10	-5		dBm
2 LO to RF Isolation	55	70		50	60		dB
2 LO to IF Isolation	35	50		35	45		dB
IP3 (Input)	-5	-2		-5	+2		dBm
Amplitude Balance		0.5			0.5		dB
Phase Balance		12			4		Deg
Total Supply Current		125	165		125	165	mA

*Data taken as IRM with external IF Hybrid

Data Taken As IRM With External IF Hybrid

Conversion Gain vs. Temperature

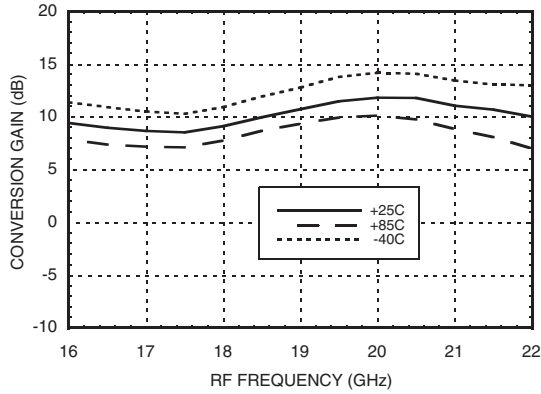
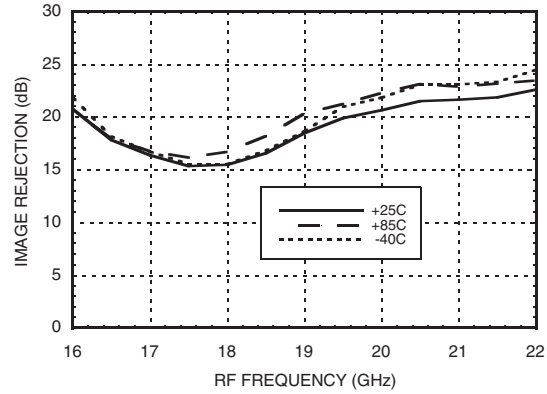
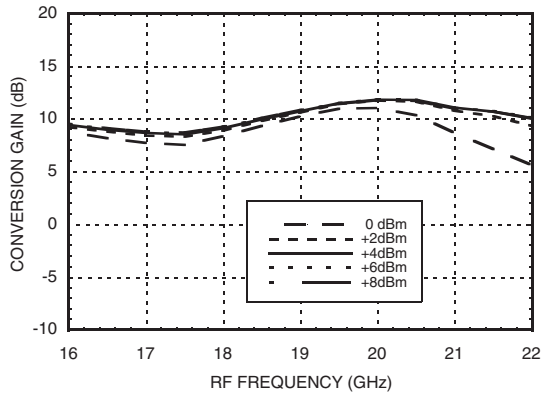

Image Rejection vs. Temperature



Conversion Gain vs. LO Drive



Return Loss

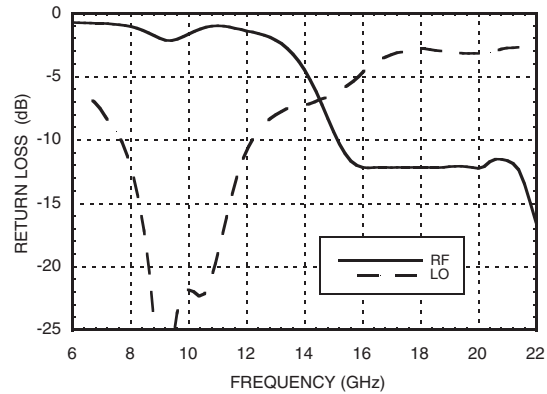

Input P1dB vs. Temperature

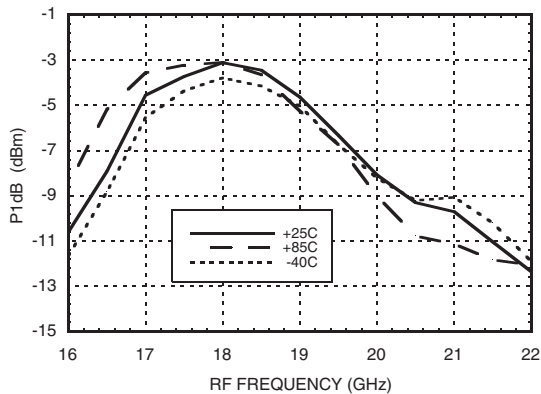

Input IP3 vs. LO Drive

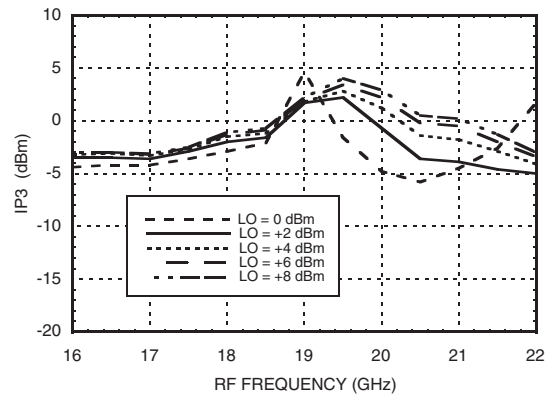

Quadrature Channel Data Taken Without IF Hybrid

Isolations

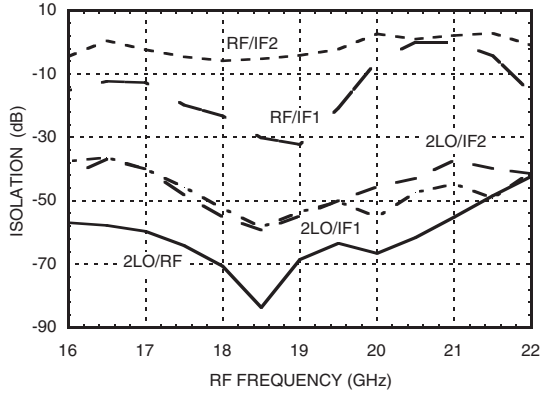

IF Bandwidth*

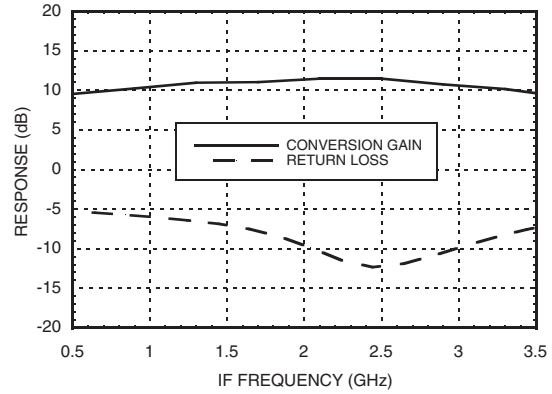

Amplitude Balance vs. LO Drive

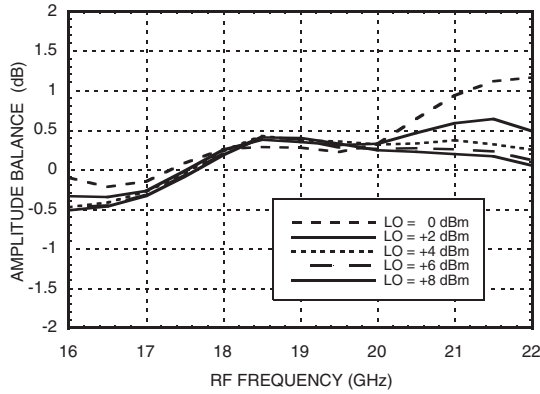

Phase Balance vs. LO Drive

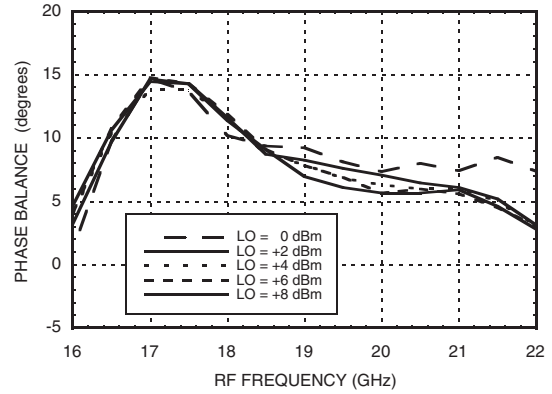

Noise Figure vs. LO Drive, LO Frequency = 8.6 GHz

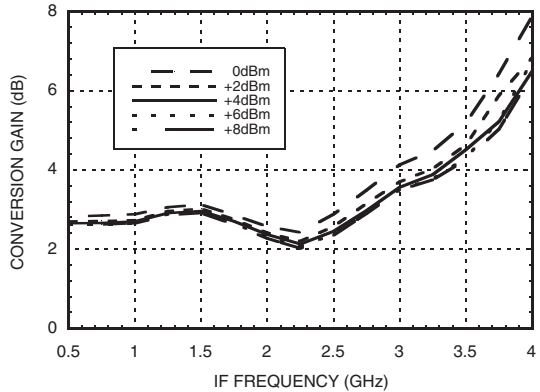

Noise Figure vs. LO Drive, IF Frequency = 100 MHz

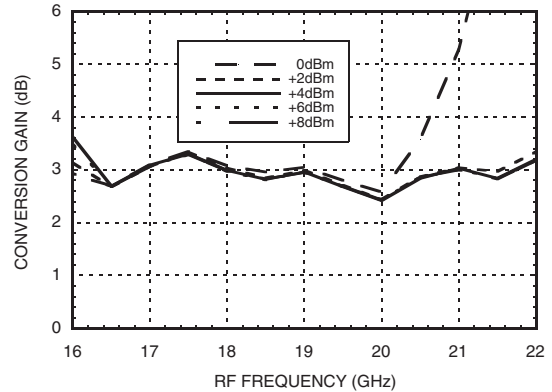

* Conversion gain data taken with external IF hybrid, LO frequency fixed at 8.6 GHz and RF varied

MxN Spurious Outputs

mRF	nLO				
	0	1	2	3	4
0	xx	21	25	32	35
1	32	26	0	25	41
2	54	81	69	61	46
3	xx	xx	xx	79	79
4	xx	xx	xx	xx	xx

RF = 18 GHz @ -20 dBm
 LO = 8.5 GHz @ +4 dBm
 Data taken without IF hybrid
 All values in dBc below IF power level (1RF -2LO = 1 GHz)

Absolute Maximum Ratings

RF	2 dBm
LO Drive	13 dBm
Vdd	5.5V
Channel Temperature	175°C
Continuous P _{diss} (T=85°C) (derate 9.56 mW/°C above 85°C)	860 mW
Thermal Resistance (R _{TH}) (channel to package bottom)	104.6 °C/W
Storage Temperature	-65 to +150 °C
Operating Temperature	-55 to +85 °C
ESD Sensitivity (HBM)	Class 1B



ELECTROSTATIC SENSITIVE DEVICE
OBSERVE HANDLING PRECAUTIONS

Outline Drawing

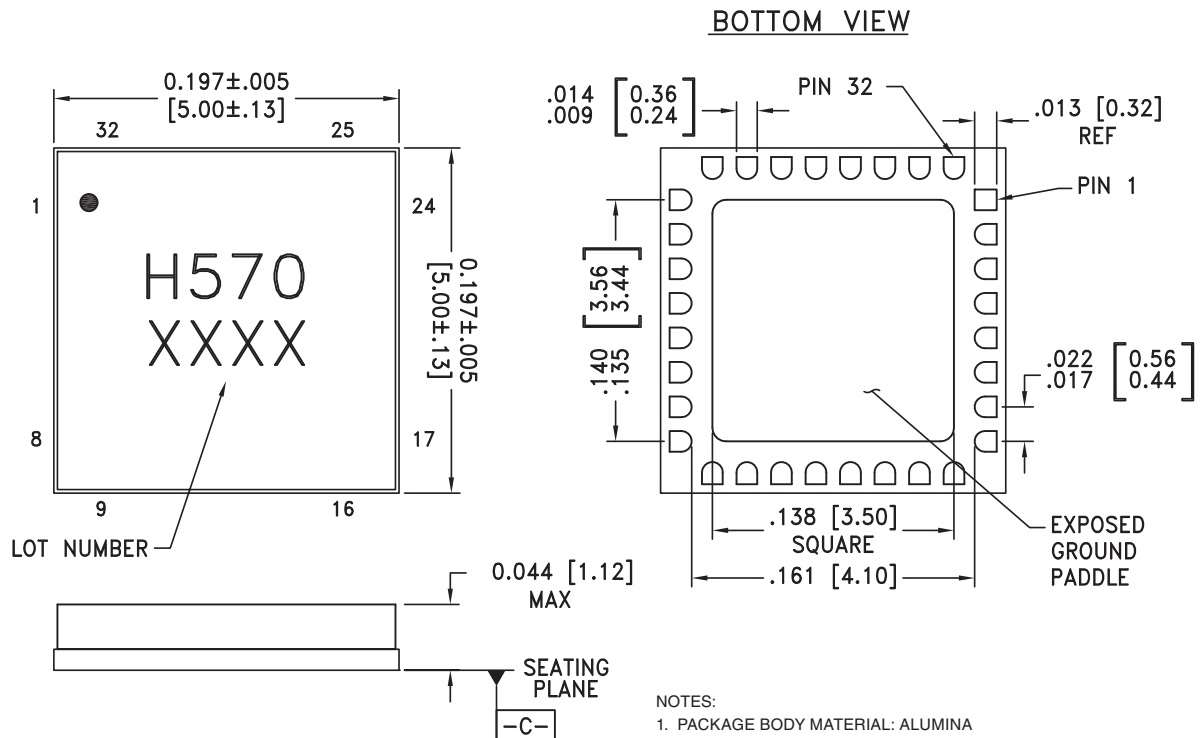

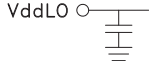
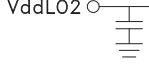
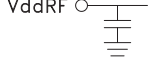
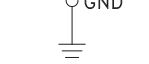
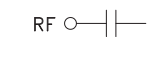
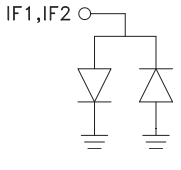
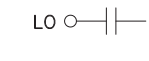

Pin Descriptions

Pin Number	Function	Description	Interface Schematic
1	VddLO	Power supply for first stage of LO amplifier.	
2, 4 - 6, 8, 9, 12 - 18, 21, 22, 25 - 28, 31, 32	N/C	No connection required. These pins may be connected to RF/DC ground without affecting performance.	
3	VddLO2	Power supply for second stage of LO amplifier.	
7	VddRF	Power supply for RF LNA.	
10, 19, 24, 29	GND	These pins and ground paddle must be connected to RF/DC ground.	
11	RF	This pin is AC coupled and matched to 50 Ohms	
20	IF2	This pin is DC coupled for applications not requiring operation to DC. This port should be DC blocked externally using a series capacitor whose value has been chosen to pass the necessary frequency range. For operation to DC, this pin must not sink / source more than 3 mA of current or part non-function and possible failure will result.	
23	IF1		
30	LO	This pin is AC coupled and matched to 50 Ohms.	

Typical Application

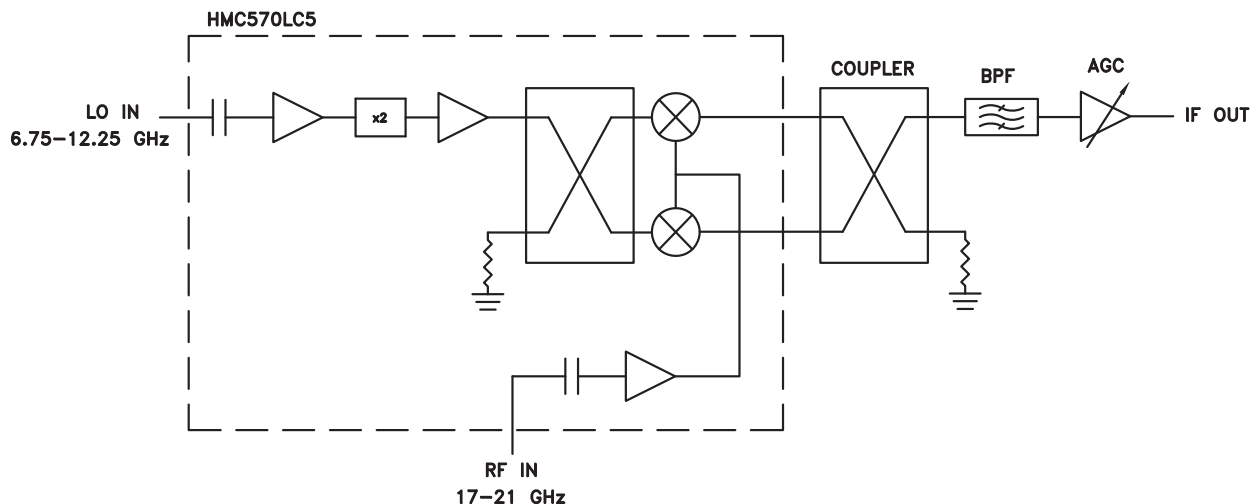

Evaluation PCB

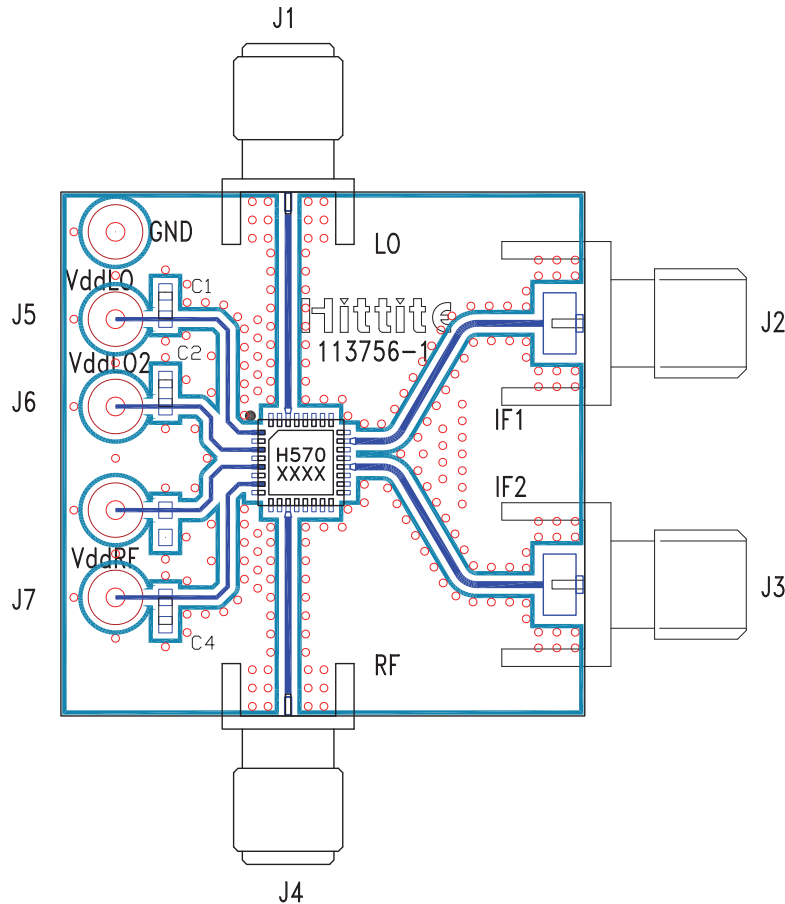

List of Materials for Evaluation PCB 113758 [1]

Item	Description
C1 - C4	Capacitor 0603, 0.01 μ F
J1, J4	PCB Mount SMA RF Connector, SRI
J2, J3	PCB Mount SMA Connector, Johnson
J5 - J7	DC Pin
U1	HMC570LC5
PCB [2]	113756 Evaluation Board

[1] Reference this number when ordering complete evaluation PCB

[2] Circuit Board Material: Rogers 4350

The circuit board used in the final application should use RF circuit design techniques. Signal lines should have 50 ohm impedance while the package ground leads and exposed paddle should be connected directly to the ground plane similar to that shown. A sufficient number of via holes should be used to connect the top and bottom ground planes. The evaluation circuit board shown is available from Hittite upon request.

Компания «Life Electronics» занимается поставками электронных компонентов импортного и отечественного производства от производителей и со складов крупных дистрибьюторов Европы, Америки и Азии.

С конца 2013 года компания активно расширяет линейку поставок компонентов по направлению коаксиальный кабель, кварцевые генераторы и конденсаторы (керамические, пленочные, электролитические), за счёт заключения дистрибьюторских договоров

Мы предлагаем:

- Конкурентоспособные цены и скидки постоянным клиентам.
- Специальные условия для постоянных клиентов.
- Подбор аналогов.
- Поставку компонентов в любых объемах, удовлетворяющих вашим потребностям.
- Приемлемые сроки поставки, возможна ускоренная поставка.
- Доставку товара в любую точку России и стран СНГ.
- Комплексную поставку.
- Работу по проектам и поставку образцов.
- Формирование склада под заказчика.
- Сертификаты соответствия на поставляемую продукцию (по желанию клиента).
- Тестирование поставляемой продукции.
- Поставку компонентов, требующих военную и космическую приемку.
- Входной контроль качества.
- Наличие сертификата ISO.

В составе нашей компании организован Конструкторский отдел, призванный помогать разработчикам, и инженерам.

Конструкторский отдел помогает осуществить:

- Регистрацию проекта у производителя компонентов.
- Техническую поддержку проекта.
- Защиту от снятия компонента с производства.
- Оценку стоимости проекта по компонентам.
- Изготовление тестовой платы монтаж и пусконаладочные работы.



Тел: +7 (812) 336 43 04 (многоканальный)

Email: org@lifeelectronics.ru