



## Features

- Balanced Mini-TRIGARD™ (5 mm diameter, 7.5 mm length)
- Ideal for board level protection of broadband circuits
- Symmetrical breakdown voltage (L-L, L-G)
- Leadless, surface mount for economical assembly
- High surge current rating, low insertion loss
- Stable breakdown throughout life
- RoHS compliant\* versions available

### 2038 Series Miniature Symmetrical 3-Electrode Surface Mount Gas Discharge Tube

Bourns offers a symmetrical surface mount (SM) 3-electrode GDT surge protection device. The industry-leading quality and features of the Bourns® miniature-TRIGARD™ series GDT continue in the 2038 symmetrical version. The 2038 series is ideal for board level protection of high bandwidth applications such as xDSL, cable broadband and high speed Ethernet, due to its symmetrical turn on characteristics as well as high energy-handling capability, long and stable life performance and low capacitance of less than 1 pF. The 2038 series breakdown voltages are nearly equal line to line as well as line to ground. Bourns® Gas Discharge Tubes (GDT) are designed to prevent damage from transient disturbances by acting as a “crowbar” in creating a virtual short-to-ground circuit during conduction. When an electrical surge exceeds the defined breakdown voltage level of the GDT, the gas becomes ionized and rapid conduction takes place. When the surge passes and the system voltage returns to normal levels, the GDT returns to its high-impedance (off) state.

## Characteristics



Test Methods per ITU-T (CCITT) K.12 and IEEE C62.31

Characteristic	Model No.				
	2038-15-SM	2038-20-SM	2038-23-SM	2038-30-SM	2038-35-SM
DC Sparkover $\pm 25\%$ @ 100 V/s L1/L2 to Gnd (NOTE 1)	150 V	200 V	230 V	300 V	350 V
Typical Impulse Sparkover L1/L2 to Gnd					
100V/ $\mu$ s	350 V	425 V	450 V	500 V	600 V
1000V/ $\mu$ s	500 V	575 V	600 V	650 V	750 V

Characteristic	Model No.				
	2038-42-SM	2038-47-SM	2038-60-SM	2038-80-SM	2038-110-SM
DC Sparkover $\pm 25\%$ @ 100 V/s L1/L2 to Gnd (NOTE 1)	420 V	470 V	600 V	800 V	1100 V
Typical Impulse Sparkover L1/L2 to Gnd					
100V/ $\mu$ s	675 V	750 V	850 V	1150 V	1500 V
1000V/ $\mu$ s	850 V	950 V	1100 V	1400 V	1700 V

Impulse Transverse Delay .....	100 V/ $\mu$ s.....	< 50 ns
Insulation Resistance (IR) .....	100 V .....	> $10^9 \Omega$
Glow Voltage .....	10 mA.....	~ 70 V
Arc Voltage .....	1 A.....	~ 10 V
Glow-Arc Transition Current .....		< 0.5 A
Capacitance.....	1 MHz .....	< 1 pF
DC Holdover Voltage (NOTE 2) .....	135 V (80 V for Model 2038-15) .....	< 150 ms
Impulse Discharge Current.....	10000 A, 8/20 $\mu$ s (NOTE 3) .....	1 operation min.
	5000 A, 8/20 $\mu$ s.....	> 10 operations
	200 A, 10/1000 $\mu$ s.....	> 300 operations
	200 A, 10/700 $\mu$ s .....	> 500 operations
	10 A, 10/1000 $\mu$ s .....	> 1500 operations
Alternating Discharge Current .....	10 Arms, 1 s (NOTE 3) .....	1 operation min.
	5 Arms, 1 s.....	> 10 operations
Operating Temperature.....		-40 to +90 °C
Climatic Category (IEC 60068-1).....		40/90/21

## Notes:

- 2038-35 UL Recognized  file E153537, 2038-110 CSA Approved  file LR93265 (UL 1449).
  - The rated discharge current for Mini-TRIGARD™ GDTs is the total current equally divided between each line to ground.
  - Surface Mount (SM) parts may show a temporary increase in DCBD after the solder reflow process. Most devices will recover within 24 hours time. It should be noted that there is no quality defect nor change in protection levels during the temporary change in DCBD.
  - Sparkover limits after life  $\pm 30\%$ . IR  $> 10^8 \Omega$ .
  - Operating characteristics per RUS PE-80 and Telcordia GR 1361 available on request.
  - At delivery AQL 0.65 Level II, DIN ISO 2859.
- <sup>1</sup> Line to Line DC Sparkover tolerance typically less than +30 % at 100 V/s.  
<sup>2</sup> Network applied.  
<sup>3</sup> DC Sparkover may exceed  $\pm 30\%$  but will continue to protect without venting.

2038 Series Miniature Symmetrical 3-Electrode Surface Mount Gas Discharge Tube



Product Dimensions

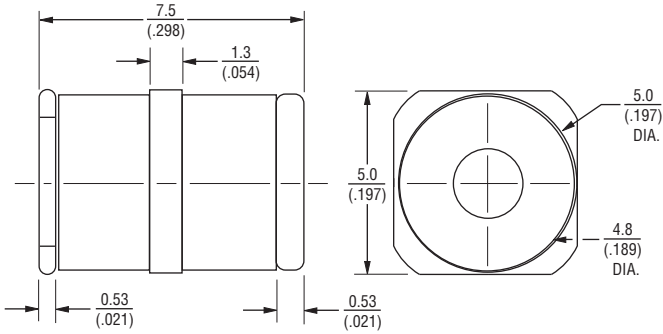

Recommended Pad Layout

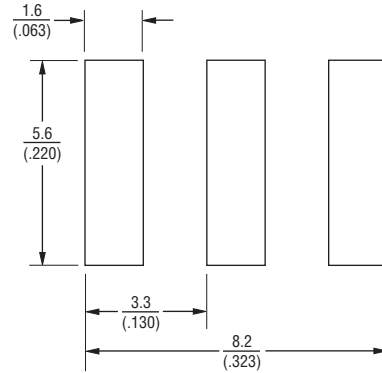

DIMENSIONS:  $\frac{\text{MM}}{\text{(INCHES)}}$

How to Order

2038 - xx - SM - RP LF

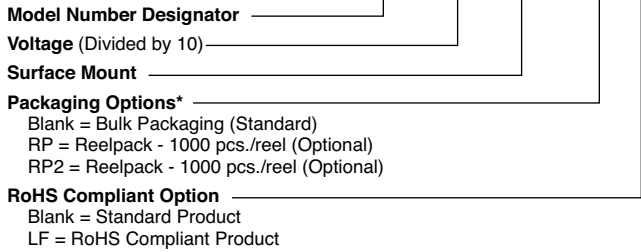

\*The optional -RP & -RP2 reelpacks contain 1000 pcs./reel. The reels are 330 mm (13 inches) in diameter. The -RP reelpack is 18 mm (0.71 inches) wide. The -RP2 reelpack is 26 mm (1.02 inches) wide.

## 2038 Series Miniature Symmetrical 3-Electrode Surface Mount Gas Discharge Tube

**BOURNS®**

### Packaging Specifications

The Model 2038-xx-SM ships standard bulk pack, 100 pieces per bag.

The optional -RP & -RP2 reelpacks contain 1000 pcs./reel. The reels are 330 mm (13 inches) in diameter. The -RP reelpack is 18 mm (0.71 inches) wide. The -RP2 reelpack is 26 mm (1.02 inches) wide.

-RP

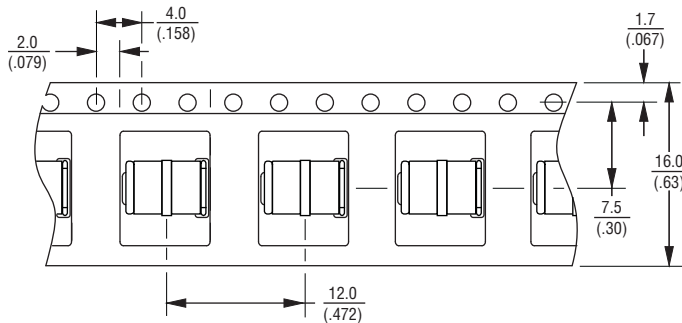

-RP2

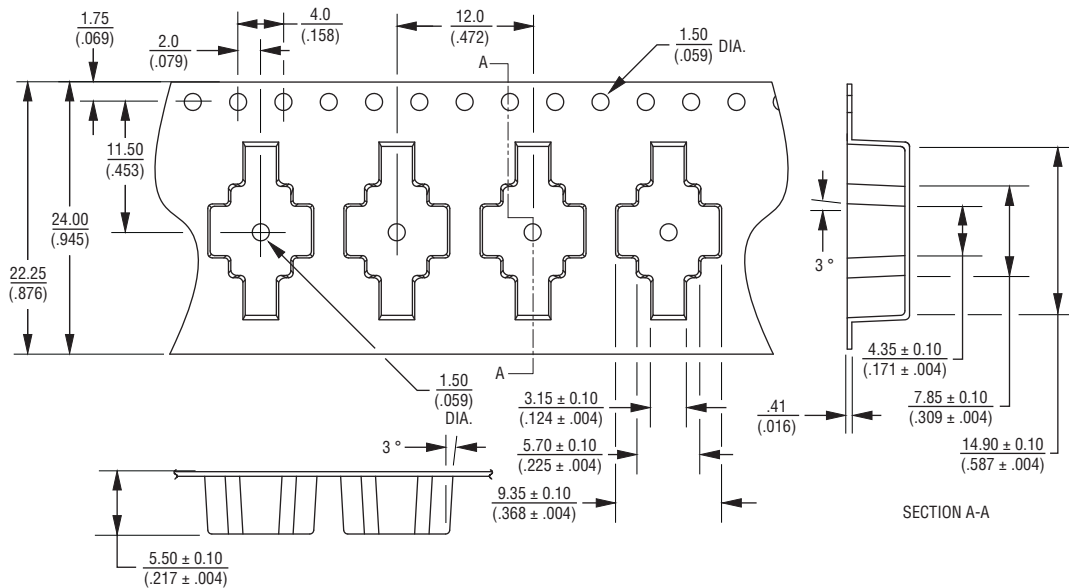

DIMENSIONS:  $\frac{\text{MM}}{\text{(INCHES)}}$

TOLERANCES:  $\frac{.13}{(.005)}$  UNLESS OTHERWISE NOTED

REV. I 12/12

Specifications are subject to change without notice.  
Customers should verify actual device performance in their specific applications.

Компания «Life Electronics» занимается поставками электронных компонентов импортного и отечественного производства от производителей и со складов крупных дистрибьюторов Европы, Америки и Азии.

С конца 2013 года компания активно расширяет линейку поставок компонентов по направлению коаксиальный кабель, кварцевые генераторы и конденсаторы (керамические, пленочные, электролитические), за счёт заключения дистрибьюторских договоров

Мы предлагаем:

- Конкурентоспособные цены и скидки постоянным клиентам.
- Специальные условия для постоянных клиентов.
- Подбор аналогов.
- Поставку компонентов в любых объемах, удовлетворяющих вашим потребностям.
- Приемлемые сроки поставки, возможна ускоренная поставка.
- Доставку товара в любую точку России и стран СНГ.
- Комплексную поставку.
- Работу по проектам и поставку образцов.
- Формирование склада под заказчика.
- Сертификаты соответствия на поставляемую продукцию (по желанию клиента).
- Тестирование поставляемой продукции.
- Поставку компонентов, требующих военную и космическую приемку.
- Входной контроль качества.
- Наличие сертификата ISO.

В составе нашей компании организован Конструкторский отдел, призванный помогать разработчикам, и инженерам.

Конструкторский отдел помогает осуществить:

- Регистрацию проекта у производителя компонентов.
- Техническую поддержку проекта.
- Защиту от снятия компонента с производства.
- Оценку стоимости проекта по компонентам.
- Изготовление тестовой платы монтаж и пусконаладочные работы.



Тел: +7 (812) 336 43 04 (многоканальный)

Email: [org@lifeelectronics.ru](mailto:org@lifeelectronics.ru)