

Single Inverter with Schmitt-Trigger Input

MC74HC1G14

The MC74HC1G14 is a high speed CMOS inverter with Schmitt-Trigger input fabricated with silicon gate CMOS technology.

The internal circuit is composed of multiple stages, including a buffer output which provides high noise immunity and stable output.

The MC74HC1G14 output drive current is 1/2 compared to MC74HC series.

Features

- High Speed: $t_{PD} = 7 \text{ ns}$ (Typ) at $V_{CC} = 5 \text{ V}$
- Low Power Dissipation: $I_{CC} = 1 \mu\text{A}$ (Max) at $T_A = 25^\circ\text{C}$
- High Noise Immunity
- Balanced Propagation Delays ($t_{PLH} = t_{PHL}$)
- Symmetrical Output Impedance ($I_{OH} = I_{OL} = 2 \text{ mA}$)
- Chip Complexity: < 100 FETs
- NLV Prefix for Automotive and Other Applications Requiring Unique Site and Control Change Requirements; AEC-Q100 Qualified and PPAP Capable
- These Devices are Pb-Free, Halogen Free/BFR Free and are RoHS Compliant

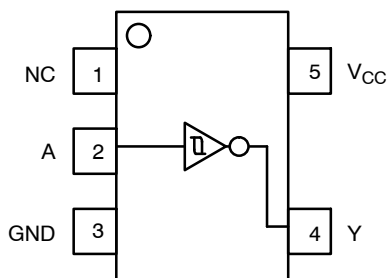

Figure 1. Pinout

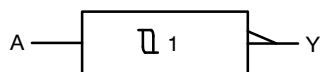

Figure 2. Logic Symbol

| PIN ASSIGNMENT | |
|----------------|----------|
| 1 | N/C |
| 2 | A |
| 3 | GND |
| 4 | Y |
| 5 | V_{CC} |



ON Semiconductor®

www.onsemi.com



SC-88A
DF SUFFIX
CASE 419A

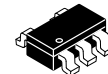

TSOP-5
DT SUFFIX
CASE 483

XX = Device Code
M = Date Code*
▪ = Pb-Free Package

(Note: Microdot may be in either location)
*Date Code orientation and/or position may vary depending upon manufacturing location.



SC-74A
DBV SUFFIX
CASE 318BQ

XXX = Specific Device Code
M = Date Code
▪ = Pb-Free Package

(Note: Microdot may be in either location)

MARKING DIAGRAMS

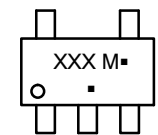
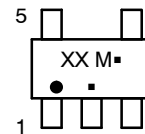
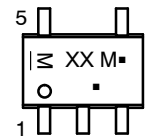

FUNCTION TABLE

| Input | Output |
|-------|--------|
| A | Y |
| L | H |
| H | L |

ORDERING INFORMATION

See detailed ordering, marking and shipping information in the package dimensions section on page 6 of this data sheet.

MC74HC1G14

MAXIMUM RATINGS

| Symbol | Parameter | Value | Unit |
|-----------------------|--|------------------------------|---------------|
| V_{CC} | DC Supply Voltage SC-88A (NLV), TSOP-5 SC-88A, SC-74A | -0.5 to +7.0 -0.5 to +6.5 | V |
| V_{IN} | DC Input Voltage | -0.5 to $V_{CC} + 0.5$ | V |
| V_{OUT} | DC Output Voltage | -0.5 to $V_{CC} + 0.5$ | V |
| I_{IK} | DC Input Diode Current | ± 20 | mA |
| I_{OK} | DC Output Diode Current | ± 20 | mA |
| I_{OUT} | DC Output Source/Sink Current | ± 12.5 | mA |
| I_{CC} or I_{GND} | DC Supply Current per Supply Pin or Ground Pin | ± 25 | mA |
| T_{STG} | Storage Temperature Range | -65 to +150 | $^{\circ}C$ |
| T_L | Lead Temperature, 1 mm from Case for 10 Seconds | 260 | $^{\circ}C$ |
| T_J | Junction Temperature Under Bias | +150 | $^{\circ}C$ |
| θ_{JA} | Thermal Resistance (Note 1) SC70-5/SC-88A/SOT-353 SOT23-5/TSOP-5/SC59-5 SC-74A | 659 555 555 | $^{\circ}C/W$ |
| P_D | Power Dissipation in Still Air at 85 $^{\circ}C$ SC70-5/SC-88A/SOT-353 SOT23-5/TSOP-5/SC59-5 SC-74A | 190 225 225 | mW |
| MSL | Moisture Sensitivity | Level 1 | |
| F_R | Flammability Rating Oxygen Index: 28 to 34 | UL 94 V-0 @ 0.125 in | |
| V_{ESD} | ESD Withstand Voltage (Note 2) Human Body Model Charged Device Model | 2000 1000 | V |
| $I_{LATCHUP}$ | Latchup Performance (Note 3) SC-88A (NLV), TSOP-5 SC-88A, SC-74A | ± 500 ± 100 | mA |

Stresses exceeding those listed in the Maximum Ratings table may damage the device. If any of these limits are exceeded, device functionality should not be assumed, damage may occur and reliability may be affected.

1. Measured with minimum pad spacing on an FR4 board, using 10 mm-by-1 inch, 20 ounce copper trace with no air flow.
2. HBM tested to ANSI/ESDA/JEDEC JS-001-2017. CDM tested to JESD22-C101-F. JEDEC recommends that ESD qualification to EIA/JESD22-A115A (Machine Model) be discontinued per JEDEC/JEP172A.
3. Tested to EIA/JESD78 Class II.

MC74HC1G14

RECOMMENDED OPERATING CONDITIONS

| Symbol | Parameter | Min | Max | Unit |
|------------|-----------------------------|--|----------|------|
| V_{CC} | DC Supply Voltage | 2.0 | 6.0 | V |
| V_{IN} | DC Input Voltage | 0.0 | V_{CC} | V |
| V_{OUT} | DC Output Voltage | 0.0 | V_{CC} | V |
| T_A | Operating Temperature Range | -55 | +125 | °C |
| t_r, t_f | Input Rise and Fall Time | SC-88A (NLV), TSOP-5 $V_{CC} = 2.0\text{ V}$ $V_{CC} = 3.0\text{ V}$ $V_{CC} = 4.5\text{ V}$ $V_{CC} = 6.0\text{ V}$ | | ns/V |
| | Input Rise and Fall Time | SC-88A, SC-74A $V_{CC} = 2.0\text{ V}$ $V_{CC} = 2.3\text{ V to }2.7\text{ V}$ $V_{CC} = 3.0\text{ V to }3.6\text{ V}$ $V_{CC} = 4.5\text{ V to }6.0\text{ V}$ | | |

Functional operation above the stresses listed in the Recommended Operating Ranges is not implied. Extended exposure to stresses beyond the Recommended Operating Ranges limits may affect device reliability.

DC ELECTRICAL CHARACTERISTICS

| Symbol | Parameter | Test Conditions | V_{CC} (V) | $T_A = 25^\circ\text{C}$ | | | $-40^\circ\text{C} \leq T_A \leq 85^\circ\text{C}$ | | $-55^\circ\text{C} \leq T_A \leq 125^\circ\text{C}$ | | Unit |
|----------|----------------------------|---|-----------------|--------------------------|------|-----------|--|-----------|---|---------------------|------|
| | | | | Min | Typ | Max | Min | Max | Min | Max | |
| V_{T+} | Positive Threshold Voltage | | 3.0 | - | 2.0 | 2.20 | - | 2.20 | - | 2.20 | V |
| | | | 4.5 | - | 3.0 | 3.15 | - | 3.15 | - | 3.15 | |
| | | | 5.5 | - | 3.6 | 3.85 | - | 3.85 | - | 3.85 | |
| V_{T-} | Negative Threshold Voltage | | 3.0 | 0.9 | 1.5 | - | 0.9 | - | 0.9 | - | V |
| | | | 4.5 | 1.35 | 2.3 | - | 1.35 | - | 1.35 | - | |
| | | | 5.5 | 1.65 | 2.9 | - | 1.65 | - | 1.65 | - | |
| V_H | Hysteresis Voltage | | 3.0 | 0.30 | 0.57 | 1.20 | 0.30 | 1.20 | 0.30 | 1.20 | V |
| | | | 4.5 | 0.40 | 0.67 | 1.40 | 0.40 | 1.40 | 0.40 | 1.40 | |
| | | | 5.5 | 0.50 | 0.74 | 1.60 | 0.50 | 1.60 | 0.50 | 1.60 | |
| V_{OH} | High-Level Output Voltage | $V_{IN} = V_{IH}$ or V_{IL} $I_{OH} = -20\ \mu\text{A}$ | 2.0 | 1.9 | 2.0 | - | 1.9 | - | 1.9 | - | V |
| | | | 3.0 | 2.9 | 3.0 | - | 2.9 | - | 2.9 | - | |
| | | | 4.5 | 4.4 | 4.5 | - | 4.4 | - | 4.4 | - | |
| | | 6.0 | 5.9 | 6.0 | - | 5.9 | - | 5.9 | - | | |
| | | $V_{IN} = V_{IH}$ or V_{IL} $I_{OH} = -2\text{ mA}$ $I_{OH} = -2.6\text{ mA}$ | 4.5 | 4.18 | 4.31 | - | 4.13 | - | 4.08 | - | |
| | | | 6.0 | 5.68 | 5.80 | - | 5.63 | - | 5.58 | - | |
| 6.0 | - | | - | - | - | - | - | - | | | |
| V_{OL} | Low-Level Output Voltage | $V_{IN} = V_{IH}$ or V_{IL} $I_{OL} = 20\ \mu\text{A}$ | 2.0 | - | 0.0 | 0.1 | - | 0.1 | - | 0.1 | V |
| | | | 3.0 | - | 0.0 | 0.1 | - | 0.1 | - | 0.1 | |
| | | | 4.5 | - | 0.0 | 0.1 | - | 0.1 | - | 0.1 | |
| | | 6.0 | - | 0.0 | 0.1 | - | 0.1 | - | 0.1 | | |
| | | $V_{IN} = V_{IH}$ or V_{IL} $I_{OL} = 2\text{ mA}$ $I_{OL} = 2.6\text{ mA}$ | 4.5 | - | 0.17 | 0.26 | - | 0.33 | - | 0.40 | |
| | | | 6.0 | - | 0.18 | 0.26 | - | 0.33 | - | 0.40 | |
| 6.0 | - | | - | - | - | - | - | - | | | |
| I_{IN} | Input Leakage Current | $V_{IN} = 6.0\text{ V}$ or GND | 6.0 | - | - | ± 0.1 | - | ± 1.0 | - | μA | |
| I_{CC} | Quiescent Supply Current | $V_{IN} = V_{CC}$ or GND | 6.0 | - | - | 1.0 | - | 10 | - | 40 μA | |

MC74HC1G14

AC ELECTRICAL CHARACTERISTICS (Input $t_r = t_f = 6.0$ ns)

| Symbol | Parameter | Test Conditions | $T_A = 25^\circ\text{C}$ | | | $-40^\circ\text{C} \leq T_A \leq 85^\circ\text{C}$ | | $-55^\circ\text{C} \leq T_A \leq 125^\circ\text{C}$ | | Unit |
|--------------------------|---|--|--------------------------|------|-----|--|-----|---|-----|------|
| | | | Min | Typ | Max | Min | Max | Min | Max | |
| t_{PLH} , t_{PHL} | Propagation Delay, Input A or B to Y | $V_{CC} = 5.0$ V $C_L = 15$ pF | - | 3.5 | 15 | - | 20 | - | 25 | ns |
| | | $V_{CC} = 2.0$ V $C_L = 50$ pF | - | 19 | 100 | - | 125 | - | 155 | |
| | | $V_{CC} = 3.0$ V | - | 10.5 | 27 | - | 35 | - | 90 | |
| | | $V_{CC} = 4.5$ V | - | 7.5 | 20 | - | 25 | - | 35 | |
| | | $V_{CC} = 6.0$ V | - | 6.5 | 17 | - | 21 | - | 26 | |
| t_{TLH} , t_{THL} | Output Transition Time | $V_{CC} = 5.0$ V $C_L = 15$ pF | - | 3 | 10 | - | 15 | - | 20 | ns |
| | | $V_{CC} = 2.0$ V $C_L = 50$ pF | - | 25 | 125 | - | 155 | - | 200 | |
| | | $V_{CC} = 3.0$ V | - | 16 | 35 | - | 45 | - | 60 | |
| | | $V_{CC} = 4.5$ V | - | 11 | 25 | - | 31 | - | 38 | |
| | | $V_{CC} = 6.0$ V | - | 9 | 21 | - | 26 | - | 32 | |
| C_{IN} | Input Capacitance | | - | 5 | 10 | - | 10 | - | 10 | pF |
| C_{PD} | Power Dissipation Capacitance (Note 4) | Typical @ 25°C, $V_{CC} = 5.0$ V | | | | | | | pF | |
| | | 10 | | | | | | | | |

4. C_{PD} is defined as the value of the internal equivalent capacitance which is calculated from the operating current consumption without load. Average operating current can be obtained by the equation: $I_{CC(OPR)} = C_{PD} \cdot V_{CC} \cdot f_{in} + I_{CC}$. C_{PD} is used to determine the no-load dynamic power consumption; $P_D = C_{PD} \cdot V_{CC}^2 \cdot f_{in} + I_{CC} \cdot V_{CC}$.

MC74HC1G14

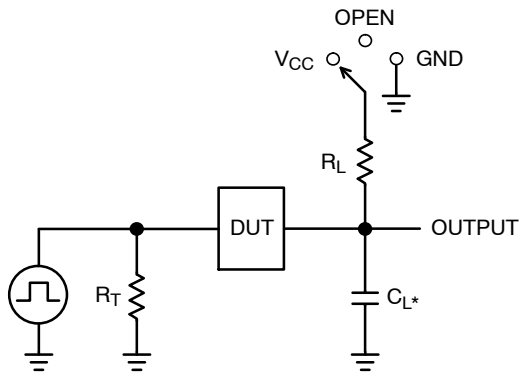

* C_L includes probe and jig capacitance
 R_T is Z_{OUT} of pulse generator (typically 50 Ω)
 $f = 1$ MHz

Figure 3. Test Circuit

| Test | Switch Position | C_L , pF | R_L , Ω |
|------------------------------|-----------------|------------------------------|------------------|
| t_{PLH} / t_{PHL} | Open | See AC Characteristics Table | X |
| t_{TLH} / t_{THL} (Note 5) | Open | | X |
| t_{PLZ} / t_{PZL} | V_{CC} | | 1 k |
| t_{PHZ} / t_{PZH} | GND | | 1 k |

X - Don't Care

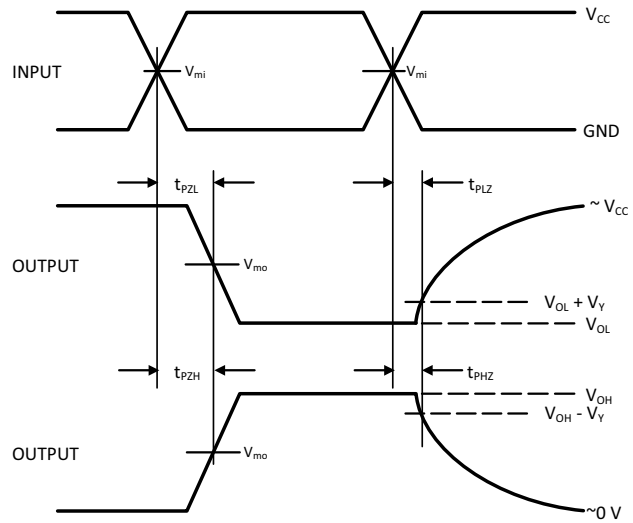
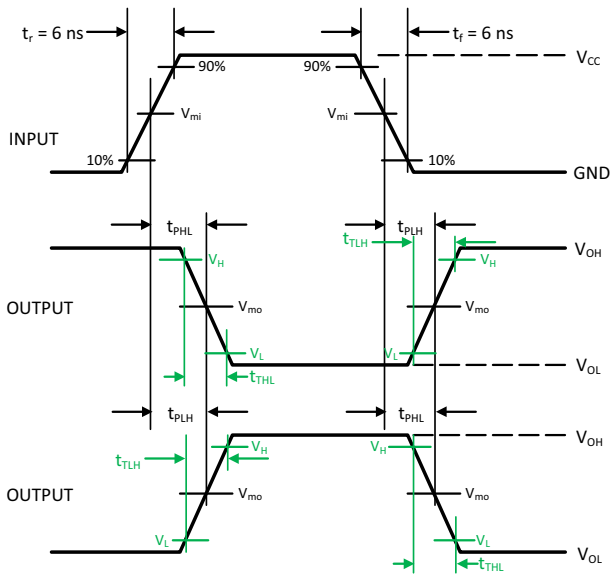

Figure 4. Switching Waveforms

| V_{CC} , V | V_{mi} , V | V_{m0} , V | | V_L , V | V_H , V | V_Y , V |
|--------------|--------------|-----------------------|---|----------------------------------|----------------------------------|-----------|
| | | t_{PLH} , t_{PHL} | t_{PZL} , t_{PLZ} , t_{PZH} , t_{PHZ} | | | |
| 3.0 to 3.6 | $V_{CC}/2$ | $(V_{OH} - V_{OL})/2$ | $V_{CC}/2$ | $V_{OL} + 0.1 (V_{OH} - V_{OL})$ | $V_{OL} + 0.9 (V_{OH} - V_{OL})$ | 0.3 |
| 4.5 to 5.5 | $V_{CC}/2$ | $(V_{OH} - V_{OL})/2$ | $V_{CC}/2$ | $V_{OL} + 0.1 (V_{OH} - V_{OL})$ | $V_{OL} + 0.9 (V_{OH} - V_{OL})$ | 0.3 |

5. t_{TLH} and t_{THL} are measured from 10% to 90% of $(V_{OH} - V_{OL})$, and 90% to 10% of $(V_{OH} - V_{OL})$, respectively.

MC74HC1G14

ORDERING INFORMATION

| Device | Packages | Specific Device Code | Pin 1 Orientation (See below) | Shipping† |
|-------------------|----------|----------------------|----------------------------------|--------------------|
| MC74HC1G14DFT1G | SC-88A | HA | Q2 | 3000 / Tape & Reel |
| NLVHC1G14DFT1G* | SC-88A | HA | Q2 | 3000 / Tape & Reel |
| MC74HC1G14DFT2G | SC-88A | HA | Q4 | 3000 / Tape & Reel |
| NLVHC1G14DFT2G* | SC-88A | HA | Q4 | 3000 / Tape & Reel |
| MC74HC1G14DTT1G | TSOP-5 | HA | Q4 | 3000 / Tape & Reel |
| NLV74HC1G14DTT1G* | TSOP-5 | HAR | Q4 | 3000 / Tape & Reel |
| MC74HC1G14DBVT1G | SC-74A | HA | Q4 | 3000 / Tape & Reel |

†For complete information on tape and reel specifications, including part orientation and tape sizes, please refer to our Tape and Reel Packaging Specifications Brochure, BRD8011/D.

*NLV Prefix for Automotive and Other Applications Requiring Unique Site and Control Change Requirements; AEC-Q100 Qualified and PPAP Capable.

Pin 1 Orientation in Tape and Reel

Direction of Feed

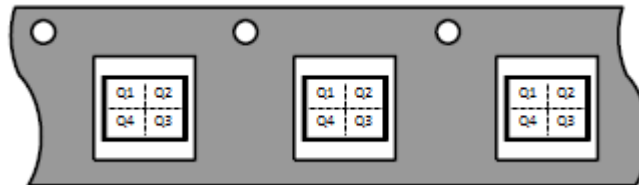

MC74HC1G14

PACKAGE DIMENSIONS

SC-88A (SC-70-5/SOT-353)
CASE 419A-02
ISSUE L

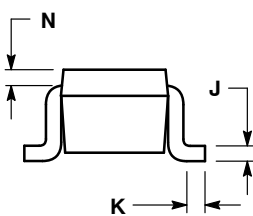
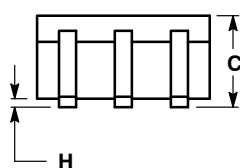
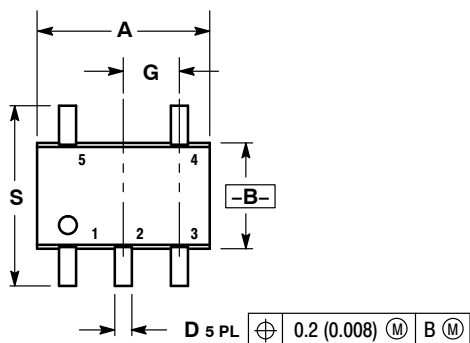

- NOTES:
1. DIMENSIONING AND TOLERANCING PER ANSI Y14.5M, 1982.
 2. CONTROLLING DIMENSION: INCH.
 3. 419A-01 OBSOLETE. NEW STANDARD 419A-02.
 4. DIMENSIONS A AND B DO NOT INCLUDE MOLD FLASH, PROTRUSIONS, OR GATE BURRS.

| DIM | INCHES | | MILLIMETERS | |
|-----|-----------|-------|-------------|------|
| | MIN | MAX | MIN | MAX |
| A | 0.071 | 0.087 | 1.80 | 2.20 |
| B | 0.045 | 0.053 | 1.15 | 1.35 |
| C | 0.031 | 0.043 | 0.80 | 1.10 |
| D | 0.004 | 0.012 | 0.10 | 0.30 |
| G | 0.026 BSC | | 0.65 BSC | |
| H | --- | 0.004 | --- | 0.10 |
| J | 0.004 | 0.010 | 0.10 | 0.25 |
| K | 0.004 | 0.012 | 0.10 | 0.30 |
| N | 0.008 REF | | 0.20 REF | |
| S | 0.079 | 0.087 | 2.00 | 2.20 |

SOLDER FOOTPRINT

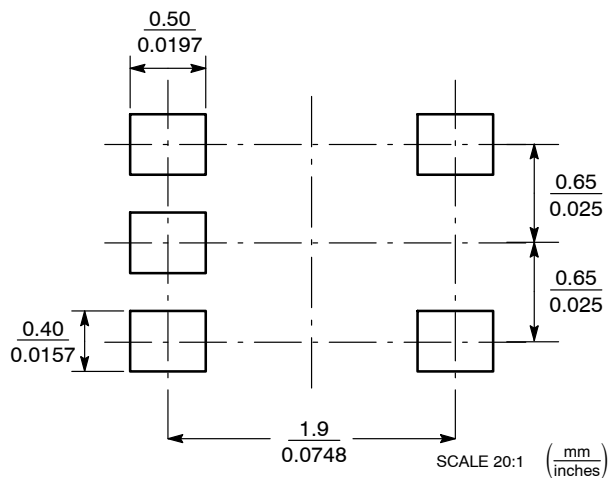

MC74HC1G14

PACKAGE DIMENSIONS

TSOP-5
CASE 483
ISSUE M

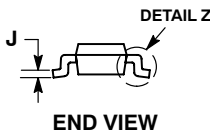
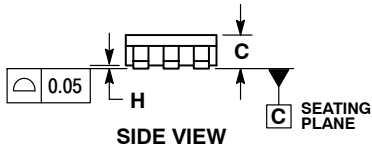
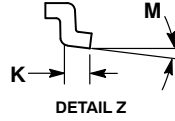
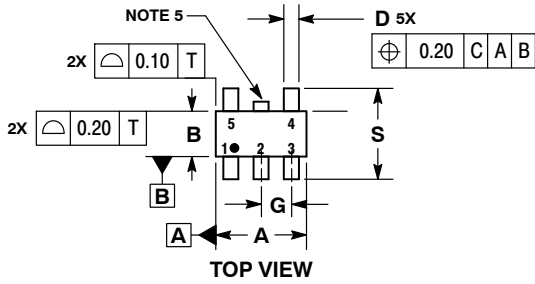

NOTES:

1. DIMENSIONING AND TOLERANCING PER ASME Y14.5M, 1994.
2. CONTROLLING DIMENSION: MILLIMETERS.
3. MAXIMUM LEAD THICKNESS INCLUDES LEAD FINISH THICKNESS. MINIMUM LEAD THICKNESS IS THE MINIMUM THICKNESS OF BASE MATERIAL.
4. DIMENSIONS A AND B DO NOT INCLUDE MOLD FLASH, PROTRUSIONS, OR GATE BURRS. MOLD FLASH, PROTRUSIONS, OR GATE BURRS SHALL NOT EXCEED 0.15 PER SIDE. DIMENSION A.
5. OPTIONAL CONSTRUCTION: AN ADDITIONAL TRIMMED LEAD IS ALLOWED IN THIS LOCATION. TRIMMED LEAD NOT TO EXTEND MORE THAN 0.2 FROM BODY.

| DIM | MILLIMETERS | |
|-----|-------------|------|
| | MIN | MAX |
| A | 2.85 | 3.15 |
| B | 1.35 | 1.65 |
| C | 0.90 | 1.10 |
| D | 0.25 | 0.50 |
| G | 0.95 BSC | |
| H | 0.01 | 0.10 |
| J | 0.10 | 0.26 |
| K | 0.20 | 0.60 |
| M | 0° 10° | |
| S | 2.50 | 3.00 |

SOLDERING FOOTPRINT*

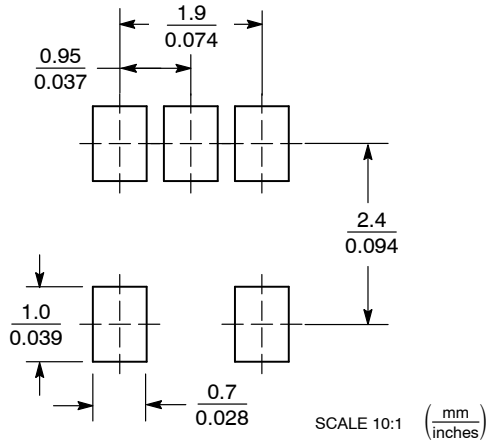

*For additional information on our Pb-Free strategy and soldering details, please download the ON Semiconductor Soldering and Mounting Techniques Reference Manual, SOLDERRM/D.

MC74HC1G14

PACKAGE DIMENSIONS

SC-74A CASE 318BQ ISSUE B

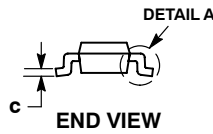
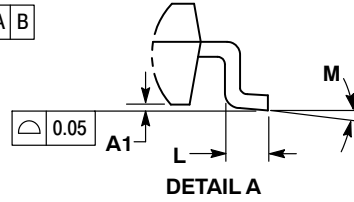
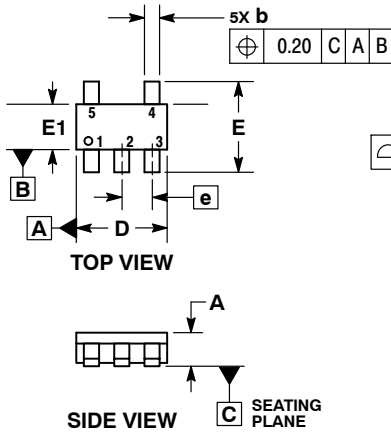

NOTES:

1. DIMENSIONING AND TOLERANCING PER ASME Y14.5M, 1994.
2. CONTROLLING DIMENSION: MILLIMETERS.
3. MAXIMUM LEAD THICKNESS INCLUDES LEAD FINISH THICKNESS. MINIMUM LEAD THICKNESS IS THE MINIMUM THICKNESS OF BASE MATERIAL.
4. DIMENSIONS A AND B DO NOT INCLUDE MOLD FLASH, PROTRUSIONS, OR GATE BURRS. MOLD FLASH, PROTRUSIONS, OR GATE BURRS SHALL NOT EXCEED 0.15 PER SIDE.

| DIM | MILLIMETERS | |
|-----|-------------|------|
| | MIN | MAX |
| A | 0.90 | 1.10 |
| A1 | 0.01 | 0.10 |
| b | 0.25 | 0.50 |
| c | 0.10 | 0.26 |
| D | 2.85 | 3.15 |
| E | 2.50 | 3.00 |
| E1 | 1.35 | 1.65 |
| e | 0.95 BSC | |
| L | 0.20 | 0.60 |
| M | 0° 10° | |

RECOMMENDED SOLDERING FOOTPRINT*

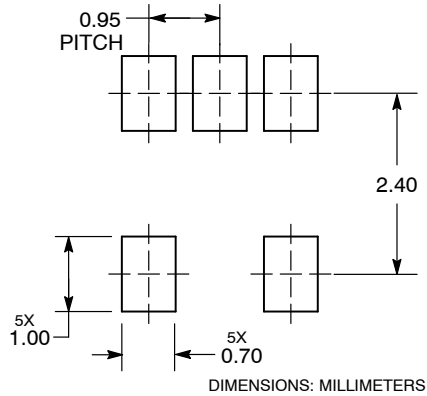

DIMENSIONS: MILLIMETERS

*For additional information on our Pb-Free strategy and soldering details, please download the ON Semiconductor Soldering and Mounting Techniques Reference Manual, SOLDERRM/D.

ON Semiconductor and are trademarks of Semiconductor Components Industries, LLC dba ON Semiconductor or its subsidiaries in the United States and/or other countries. ON Semiconductor owns the rights to a number of patents, trademarks, copyrights, trade secrets, and other intellectual property. A listing of ON Semiconductor's product/patent coverage may be accessed at www.onsemi.com/site/pdf/Patent-Marking.pdf. ON Semiconductor reserves the right to make changes without further notice to any products herein. ON Semiconductor makes no warranty, representation or guarantee regarding the suitability of its products for any particular purpose, nor does ON Semiconductor assume any liability arising out of the application or use of any product or circuit, and specifically disclaims any and all liability, including without limitation special, consequential or incidental damages. Buyer is responsible for its products and applications using ON Semiconductor products, including compliance with all laws, regulations and safety requirements or standards, regardless of any support or applications information provided by ON Semiconductor. "Typical" parameters which may be provided in ON Semiconductor data sheets and/or specifications can and do vary in different applications and actual performance may vary over time. All operating parameters, including "Typicals" must be validated for each customer application by customer's technical experts. ON Semiconductor does not convey any license under its patent rights nor the rights of others. ON Semiconductor products are not designed, intended, or authorized for use as a critical component in life support systems or any FDA Class 3 medical devices or medical devices with a same or similar classification in a foreign jurisdiction or any devices intended for implantation in the human body. Should Buyer purchase or use ON Semiconductor products for any such unintended or unauthorized application, Buyer shall indemnify and hold ON Semiconductor and its officers, employees, subsidiaries, affiliates, and distributors harmless against all claims, costs, damages, and expenses, and reasonable attorney fees arising out of, directly or indirectly, any claim of personal injury or death associated with such unintended or unauthorized use, even if such claim alleges that ON Semiconductor was negligent regarding the design or manufacture of the part. ON Semiconductor is an Equal Opportunity/Affirmative Action Employer. This literature is subject to all applicable copyright laws and is not for resale in any manner.

PUBLICATION ORDERING INFORMATION

LITERATURE FULFILLMENT:
Email Requests to: orderlit@onsemi.com

TECHNICAL SUPPORT
North American Technical Support:
Voice Mail: 1 800-282-9855 Toll Free USA/Canada
Phone: 011 421 33 790 2910

Europe, Middle East and Africa Technical Support:
Phone: 00421 33 790 2910
For additional information, please contact your local Sales Representative

Компания «Life Electronics» занимается поставками электронных компонентов импортного и отечественного производства от производителей и со складов крупных дистрибьюторов Европы, Америки и Азии.

С конца 2013 года компания активно расширяет линейку поставок компонентов по направлению коаксиальный кабель, кварцевые генераторы и конденсаторы (керамические, пленочные, электролитические), за счёт заключения дистрибьюторских договоров

Мы предлагаем:

- Конкурентоспособные цены и скидки постоянным клиентам.
- Специальные условия для постоянных клиентов.
- Подбор аналогов.
- Поставку компонентов в любых объемах, удовлетворяющих вашим потребностям.
- Приемлемые сроки поставки, возможна ускоренная поставка.
- Доставку товара в любую точку России и стран СНГ.
- Комплексную поставку.
- Работу по проектам и поставку образцов.
- Формирование склада под заказчика.
- Сертификаты соответствия на поставляемую продукцию (по желанию клиента).
- Тестирование поставляемой продукции.
- Поставку компонентов, требующих военную и космическую приемку.
- Входной контроль качества.
- Наличие сертификата ISO.

В составе нашей компании организован Конструкторский отдел, призванный помогать разработчикам, и инженерам.

Конструкторский отдел помогает осуществить:

- Регистрацию проекта у производителя компонентов.
- Техническую поддержку проекта.
- Защиту от снятия компонента с производства.
- Оценку стоимости проекта по компонентам.
- Изготовление тестовой платы монтаж и пусконаладочные работы.



Тел: +7 (812) 336 43 04 (многоканальный)

Email: org@lifeelectronics.ru