

# HLMP-CBxx, HLMP-CMxx

## T-1¾ (5 mm) InGaN Blue and Green LEDs



## Data Sheet



Lead (Pb) Free  
RoHS 6 fully  
compliant



### Description

This high intensity blue and green LEDs are based on the most efficient and cost effective InGaN material technology.

These LED lamps are untinted and non-diffused T-1¾ packages incorporating second generation optics producing well defined spatial radiation patterns at specific viewing cone angles.

These lamps are made with an advanced optical grade epoxy offering superior high temperature and high moisture resistance performance in outdoor signal and sign application. The epoxy contains uv inhibitor to reduce the effects of long term exposure to direct sunlight.

### Features

- Viewing angle: 15°, 23° and 30°
- Well defined spatial radiation pattern
- High luminous output
- Available in Blue and Green
  - Blue 470 nm
  - Green 525 nm
- Superior resistance to moisture
- Standoff and non-standoff Package

### Applications

- Traffic signs
- Variable Message Sign
- Commercial outdoor advertising

**CAUTION:** InGaN devices are Class 1C HBM ESD sensitive per JEDEC Standard. Please observe appropriate precautions during handling and processing. Refer to Application Note AN-1142 for additional details.

## Package Dimensions

### Drawing A (Non-standoff)

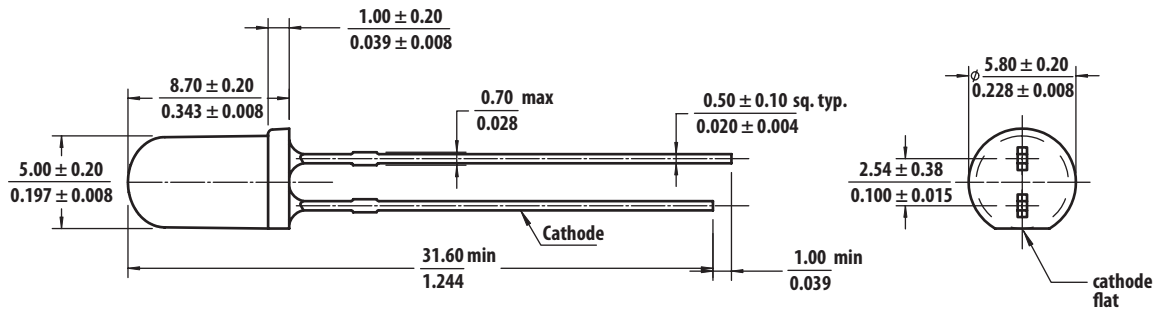

### Drawing B (Standoff)

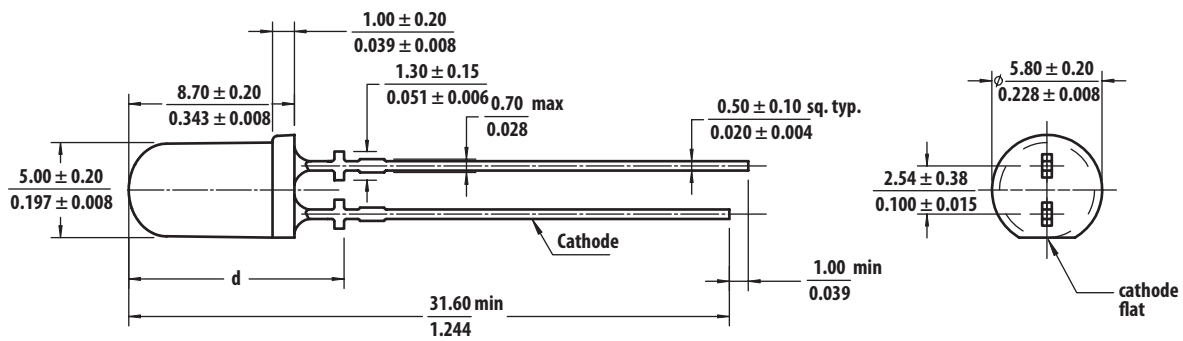

| Part Number | Dimension 'd'       |
|-------------|---------------------|
| HLMP-Cx1H   | $12.39 \pm 0.25$ mm |
| HLMP-Cx2H   | $12.35 \pm 0.25$ mm |
| HLMP-Cx3H   | $11.93 \pm 0.25$ mm |

#### Notes:

1. All dimensions in millimeters (inches).
2. Tolerance is  $\pm 0.20$  mm unless other specified.
3. Leads are mild steel with tin plating.
4. The epoxy meniscus is 1.5 mm max.

## Device Selection Guide

| Part Number     | Color and Dominant Wavelength $\lambda_d$ (nm) Typ <sup>[3]</sup> | Luminous Intensity I <sub>v</sub> (mcd) at 20 mA <sup>[1,2,5]</sup> |       |          | Typical Viewing angle (°) <sup>[4]</sup> |
|-----------------|---|---|-------|----------|--|
|                 |   | Min   | Max   | Standoff |  |
| HLMP-CB1G-WY0DD | Blue 470  | 5500  | 12000 | No       | 15                                       |
| HLMP-CB1H-WY0DD | Blue 470  | 5500  | 12000 | Yes      |  |
| HLMP-CM1G-350DD | Green 525   | 27000   | 59000 | No       |  |
| HLMP-CM1H-350DD | Green 525   | 27000   | 59000 | Yes      |  |
| HLMP-CB2G-UW0DD | Blue 470  | 3200  | 7200  | No       | 23                                       |
| HLMP-CB2H-UW0DD | Blue 470  | 3200  | 7200  | Yes      |  |
| HLMP-CM2G-Z20DD | Green 525   | 12000   | 27000 | No       |  |
| HLMP-CM2H-Z20DD | Green 525   | 12000   | 27000 | Yes      |  |
| HLMP-CB3G-TV0DD | Blue 470  | 2500  | 5500  | No       | 30                                       |
| HLMP-CB3H-TV0DD | Blue 470  | 2500  | 5500  | Yes      |  |
| HLMP-CM3G-Y10DD | Green 525   | 9300  | 21000 | No       |  |
| HLMP-CM3H-Y10DD | Green 525   | 9300  | 21000 | Yes      |  |

### Notes:

1. The luminous intensity is measured on the mechanical axis of the lamp package and it is tested with pulsing condition.
2. The optical axis is closely aligned with the package mechanical axis.
3. Dominant wavelength,  $\lambda_d$ , is derived from the CIE Chromaticity Diagram and represents the color of the lamp.
4.  $\theta_{1/2}$  is the off-axis angle where the luminous intensity is half the on-axis intensity.
5. Tolerance for each bin limit is  $\pm 15\%$

## Part Numbering System

HLMP - C x xx - x x x xx

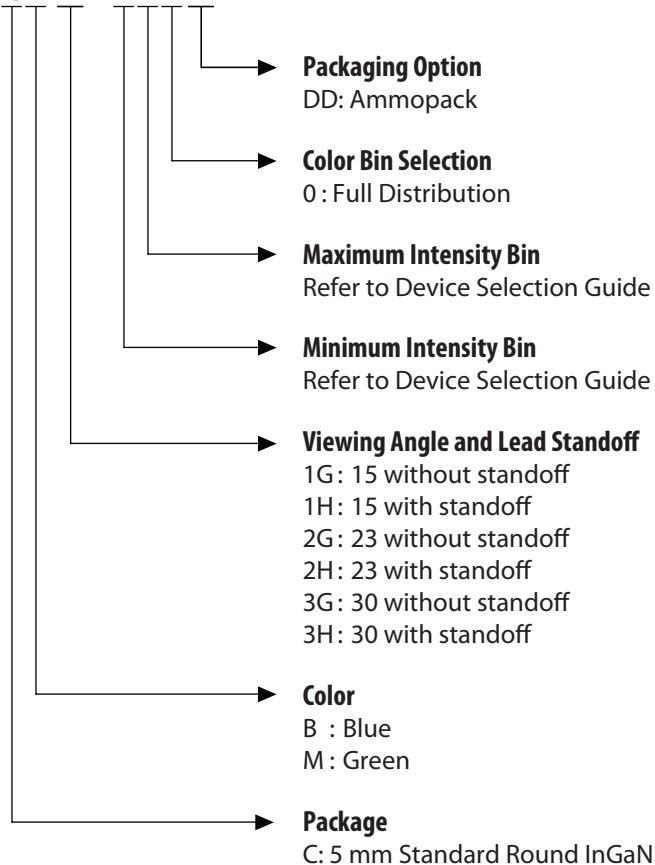

## Absolute Maximum Ratings

$T_J = 25^\circ\text{C}$

| Parameter                         | Blue/Green         | Unit             |
|-----------------------------------|--------------------|------------------|
| DC Forward Current <sup>[1]</sup> | 30                 | mA               |
| Peak Forward Current              | 100 <sup>[2]</sup> | mA               |
| Power Dissipation                 | 110                | mW               |
| LED Junction Temperature          | 110                | $^\circ\text{C}$ |
| Operating Temperature Range       | -40 to +85         | $^\circ\text{C}$ |
| Storage Temperature Range         | -40 to +100        | $^\circ\text{C}$ |

Notes:

1. Derate linearly as shown in Figure 4.
2. Duty Factor 10%, frequency 1 kHz.

## Electrical / Optical Characteristics

$T_J = 25^\circ\text{C}$

| Parameter   | Symbol            | Min.       | Typ.         | Max.       | Units                     | Test Conditions   |
|---|-------------------|------------|--------------|------------|---------------------------|---|
| Forward Voltage<br>Blue & Green                     | $V_F$             | 2.8        | 3.1          | 3.6        | V                         | $I_F = 20\text{ mA}$  |
| Reverse Voltage <sup>[3]</sup><br>Blue & Green      | $V_R$             | 5          |              |            | V                         | $I_R = 10\ \mu\text{A}$   |
| Dominant Wavelength <sup>[1]</sup><br>Blue<br>Green | $\lambda_d$       | 460<br>520 | 470<br>525   | 480<br>540 | nm                        | $I_F = 20\text{ mA}$  |
| Peak Wavelength<br>Blue<br>Green                    | $\lambda_{PEAK}$  |            | 461<br>517   |            | nm                        | Peak of Wavelength of Spectral Distribution at $I_F = 20\text{ mA}$           |
| Thermal resistance                                  | $R\theta_{J-PIN}$ |            | 240          |            | $^\circ\text{C}/\text{W}$ | LED junction to pin   |
| Luminous Efficacy <sup>[2]</sup><br>Blue<br>Green   | $\eta_V$          |            | 68<br>475    |            | lm/W                      | Emitted Luminous Power/<br>Emitted Radiant Power                              |
| Thermal coefficient of $\lambda_d$<br>Blue<br>Green |                   |            | 0.02<br>0.03 |            | nm/ $^\circ\text{C}$      | $I_F = 20\text{ mA};$<br>$+25^\circ\text{C} \leq T_J \leq +100^\circ\text{C}$ |

Notes:

1. The dominant wavelength is derived from the Chromaticity Diagram and represents the color of the lamp.
2. The radiant intensity,  $I_e$  in watts per steradian, maybe found from the equation  $I_e = I_v / \eta_V$  where  $I_v$  is the luminous intensity in candelas and  $\eta_V$  is the luminous efficacy in lumens/ watt.
3. Indicates product final testing condition, long term reverse bias is not recommended.

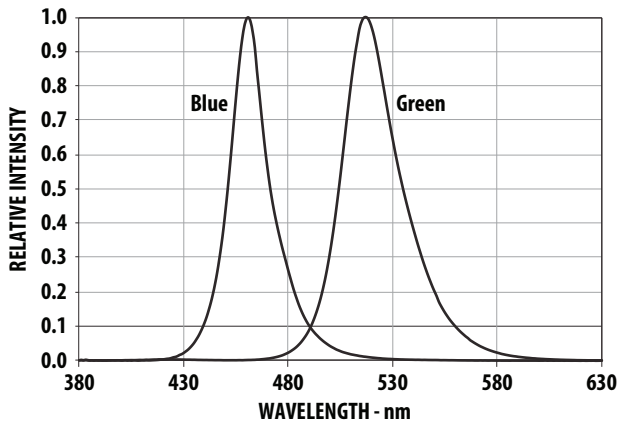

Figure 1. Relative Intensity vs Wavelength

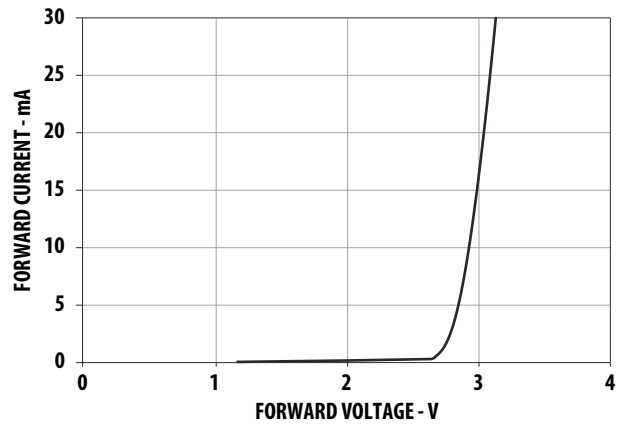

Figure 2. Forward Current vs Forward Voltage

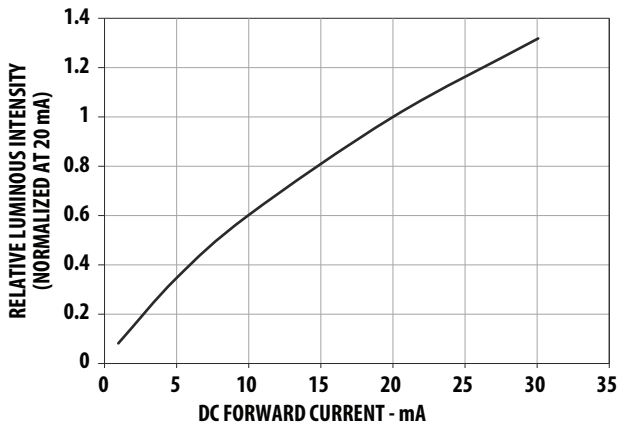

Figure 3. Relative Intensity vs Forward Current

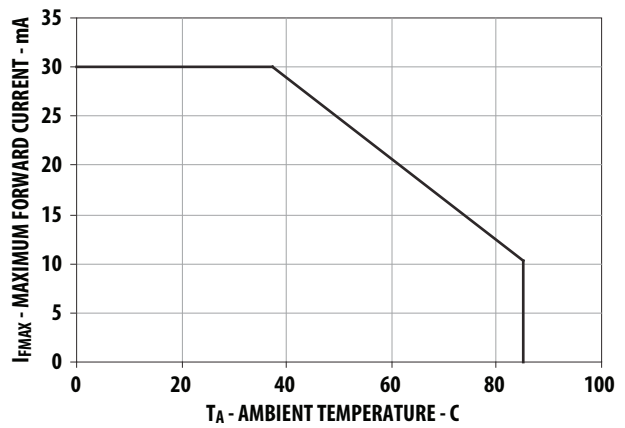

Figure 4. Maximum Forward Current vs Ambient Temperature

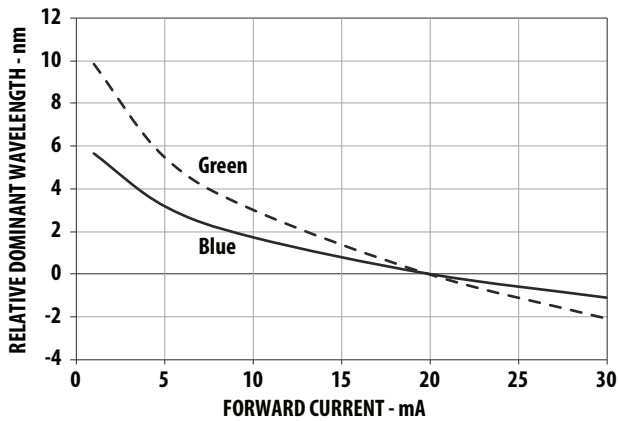

Figure 5. Relative Dominant Wavelength Shift vs Forward Current

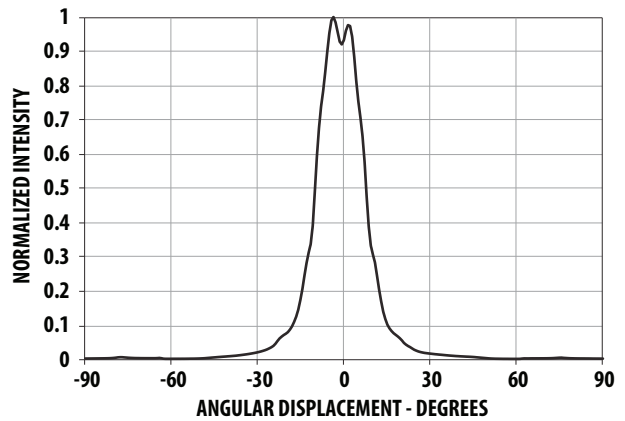

Figure 6. Representative Radiation pattern for 15° Viewing Angle Lamp

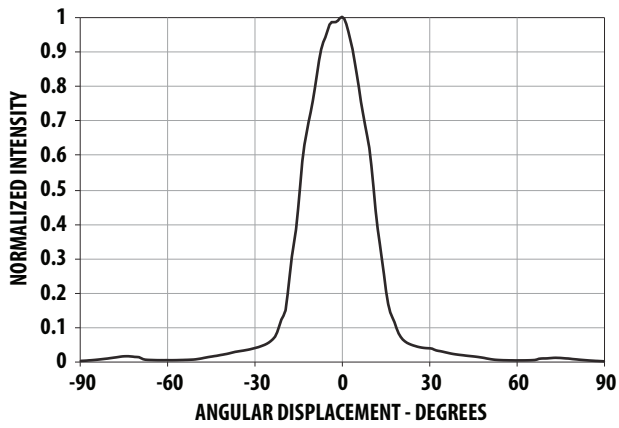

Figure 7. Representative Radiation pattern for 23° Viewing Angle Lamp

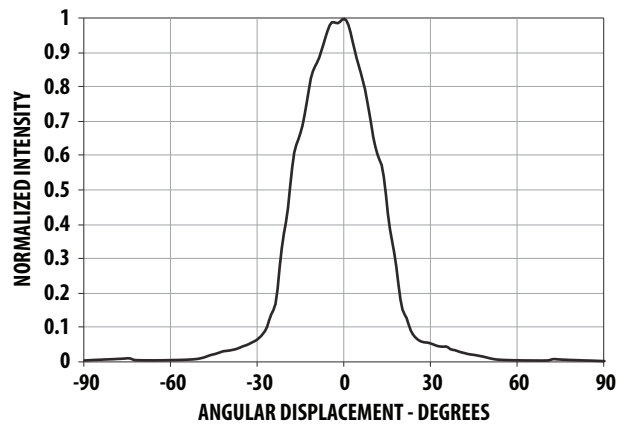

Figure 8. Representative Radiation pattern for 30° Viewing Angle Lamp

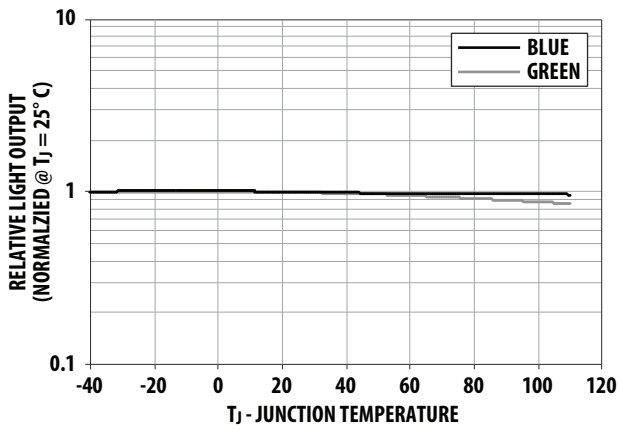

Figure 9. Relative Light Output vs Junction Temperature

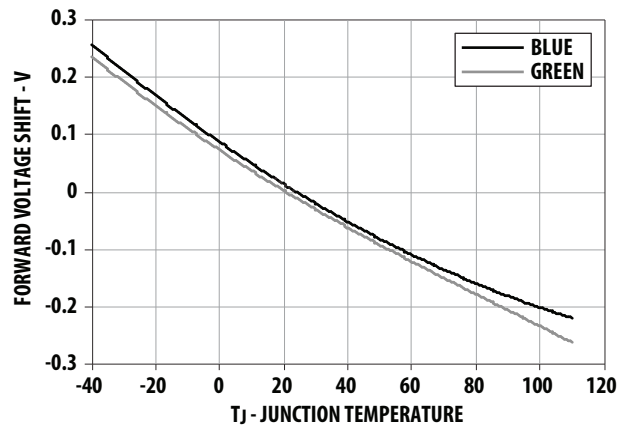

Figure 10. Forward Voltage Shift vs Junction Temperature

### Intensity Bin Limit Table (1.3 : 1 Iv Bin Ratio)

| Bin | Intensity (mcd) at 20 mA |       |
|-----|--------------------------|-------|
|     | Min                      | Max   |
| T   | 2500                     | 3200  |
| U   | 3200                     | 4200  |
| V   | 4200                     | 5500  |
| W   | 5500                     | 7200  |
| X   | 7200                     | 9300  |
| Y   | 9300                     | 12000 |
| Z   | 12000                    | 16000 |
| 1   | 16000                    | 21000 |
| 2   | 21000                    | 27000 |
| 3   | 27000                    | 35000 |
| 4   | 35000                    | 45000 |
| 5   | 45000                    | 59000 |

Tolerance for each bin limit is  $\pm 15\%$

### Green Color Bin Table

| Bin | Min Dom | Max Dom | Xmin   | Ymin   | Xmax   | Ymax   |
|-----|---------|---------|--------|--------|--------|--------|
| 1   | 520.0   | 524.0   | 0.0743 | 0.8338 | 0.1856 | 0.6556 |
|     |         |         | 0.1650 | 0.6586 | 0.1060 | 0.8292 |
| 2   | 524.0   | 528.0   | 0.1060 | 0.8292 | 0.2068 | 0.6463 |
|     |         |         | 0.1856 | 0.6556 | 0.1387 | 0.8148 |
| 3   | 528.0   | 532.0   | 0.1387 | 0.8148 | 0.2273 | 0.6344 |
|     |         |         | 0.2068 | 0.6463 | 0.1702 | 0.7965 |
| 4   | 532.0   | 536.0   | 0.1702 | 0.7965 | 0.2469 | 0.6213 |
|     |         |         | 0.2273 | 0.6344 | 0.2003 | 0.7764 |
| 5   | 536.0   | 540.0   | 0.2003 | 0.7764 | 0.2659 | 0.6070 |
|     |         |         | 0.2469 | 0.6213 | 0.2296 | 0.7543 |

Tolerance for each bin limit is  $\pm 0.5$  nm.

### Blue Color Bin Table

| Bin | Min Dom | Max Dom | Xmin   | Ymin   | Xmax   | Ymax   |
|-----|---------|---------|--------|--------|--------|--------|
| 1   | 460.0   | 464.0   | 0.1440 | 0.0297 | 0.1766 | 0.0966 |
|     |         |         | 0.1818 | 0.0904 | 0.1374 | 0.0374 |
| 2   | 464.0   | 468.0   | 0.1374 | 0.0374 | 0.1699 | 0.1062 |
|     |         |         | 0.1766 | 0.0966 | 0.1291 | 0.0495 |
| 3   | 468.0   | 472.0   | 0.1291 | 0.0495 | 0.1616 | 0.1209 |
|     |         |         | 0.1699 | 0.1062 | 0.1187 | 0.0671 |
| 4   | 472.0   | 476.0   | 0.1187 | 0.0671 | 0.1517 | 0.1423 |
|     |         |         | 0.1616 | 0.1209 | 0.1063 | 0.0945 |
| 5   | 476.0   | 480.0   | 0.1063 | 0.0945 | 0.1397 | 0.1728 |
|     |         |         | 0.1517 | 0.1423 | 0.0913 | 0.1327 |

Tolerance for each bin limit is  $\pm 0.5$  nm

Note:

- All bin categories are established for classification of products. Products may not be available in all bin categories. Please contact your Avago representative for further information.

### Avago Color Bin on CIE 1931 Chromaticity Diagram

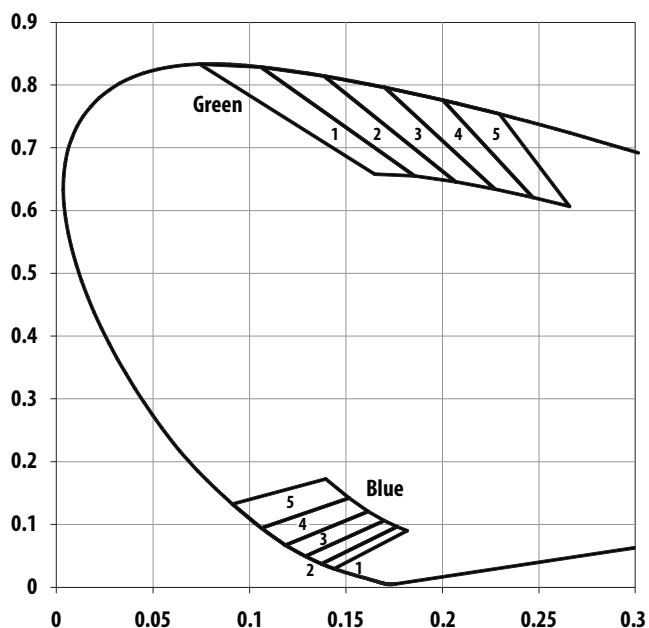

## Precautions:

### Lead Forming:

- The leads of an LED lamp may be preformed or cut to length prior to insertion and soldering on PC board.
- For better control, it is recommended to use proper tool to precisely form and cut the leads to applicable length rather than doing it manually.
- If manual lead cutting is necessary, cut the leads after the soldering process. The solder connection forms a mechanical ground which prevents mechanical stress due to lead cutting from traveling into LED package. This is highly recommended for hand solder operation, as the excess lead length also acts as small heat sink.

### Soldering and Handling:

- Care must be taken during PCB assembly and soldering process to prevent damage to the LED component.
- LED component may be effectively hand soldered to PCB. However, it is only recommended under unavoidable circumstances such as rework. The closest manual soldering distance of the soldering heat source (soldering iron's tip) to the body is 1.59mm. Soldering the LED using soldering iron tip closer than 1.59mm might damage the LED.
- ESD precaution must be properly applied on the

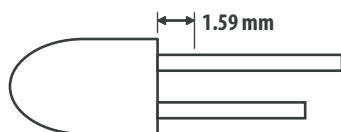

soldering station and personnel to prevent ESD damage to the LED component that is ESD sensitive. Do refer to Avago application note AN 1142 for details. The soldering iron used should have grounded tip to ensure electrostatic charge is properly grounded.

- Recommended soldering condition:

|                      | Wave Soldering [1,2] | Manual Solder Dipping |
|----------------------|----------------------|-----------------------|
| Pre-heat temperature | 105° C Max.          | –                     |
| Preheat time         | 60 sec Max           | –                     |
| Peak temperature     | 260° C Max.          | 260° C Max.           |
| Dwell time           | 5 sec Max.           | 5 sec Max             |

Note:

1. Above conditions refers to measurement with thermocouple mounted at the bottom of PCB.
2. It is recommended to use only bottom preheaters in order to reduce thermal stress experienced by LED.

- Wave soldering parameters must be set and maintained according to the recommended temperature and dwell time. Customer is advised to perform daily check on the soldering profile to ensure that it is always conforming to recommended soldering conditions.

Note:

1. PCB with different size and design (component density) will have different heat mass (heat capacity). This might cause a change in temperature experienced by the board if same wave soldering setting is used. So, it is recommended to re-calibrate the soldering profile again before loading a new type of PCB.

### Avago Technologies LED Configuration

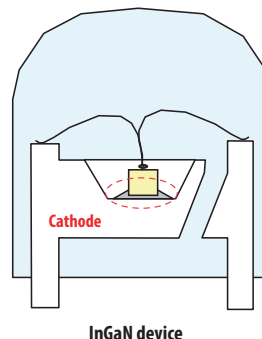

- Any alignment fixture that is being applied during wave soldering should be loosely fitted and should not apply weight or force on LED. Non metal material is recommended as it will absorb less heat during wave soldering process.
- At elevated temperature, LED is more susceptible to mechanical stress. Therefore, PCB must allowed to cool down to room temperature prior to handling, which includes removal of alignment fixture or pallet.
- If PCB board contains both through hole (TH) LED and other surface mount components, it is recommended that surface mount components be soldered on the top side of the PCB. If surface mount need to be on the bottom side, these components should be soldered using reflow soldering prior to insertion the TH LED.
- Recommended PC board plated through holes (PTH) size for LED component leads.

| LED component lead size                | Diagonal                 | Plated through hole diameter             |
|--|--------------------------|--|
| 0.45 x 0.45 mm<br>(0.018 x 0.018 inch) | 0.636 mm<br>(0.025 inch) | 0.98 to 1.08 mm<br>(0.039 to 0.043 inch) |
| 0.50 x 0.50 mm<br>(0.020 x 0.020 inch) | 0.707 mm<br>(0.028 inch) | 1.05 to 1.15 mm<br>(0.041 to 0.045 inch) |

- Over-sizing the PTH can lead to twisted LED after clinching. On the other hand under sizing the PTH can cause difficulty inserting the TH LED.

Refer to application note AN5334 for more information about soldering and handling of high brightness TH LED lamps.



### Example of Wave Soldering Temperature Profile for TH LED

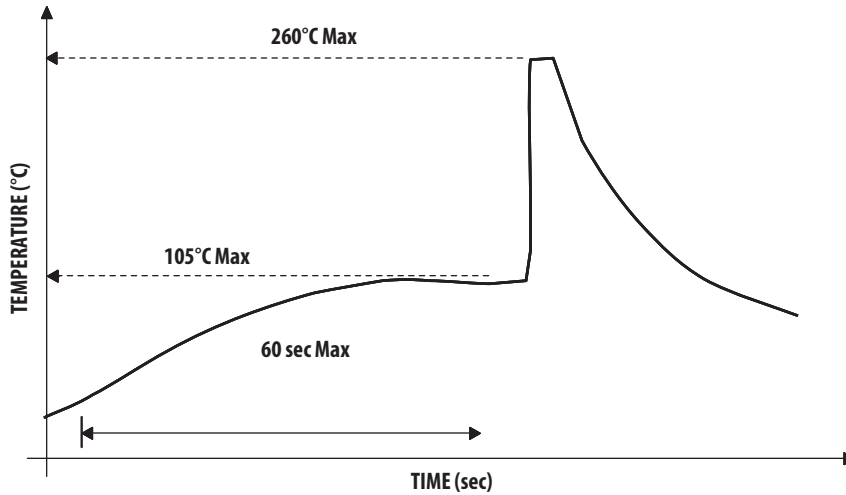

Recommended solder:  
 Sn63 (Leaded solder alloy)  
 SAC305 (Lead free solder alloy)

Flux: Rosin flux

Solder bath temperature: 255°C ± 5°C  
 (maximum peak temperature = 260°C)

Dwell time: 3.0 sec - 5.0 sec  
 (maximum = 5sec)

Note: Allow for board to be sufficiently cooled to room temperature before exerting mechanical force.

### Ammo Packs Drawing

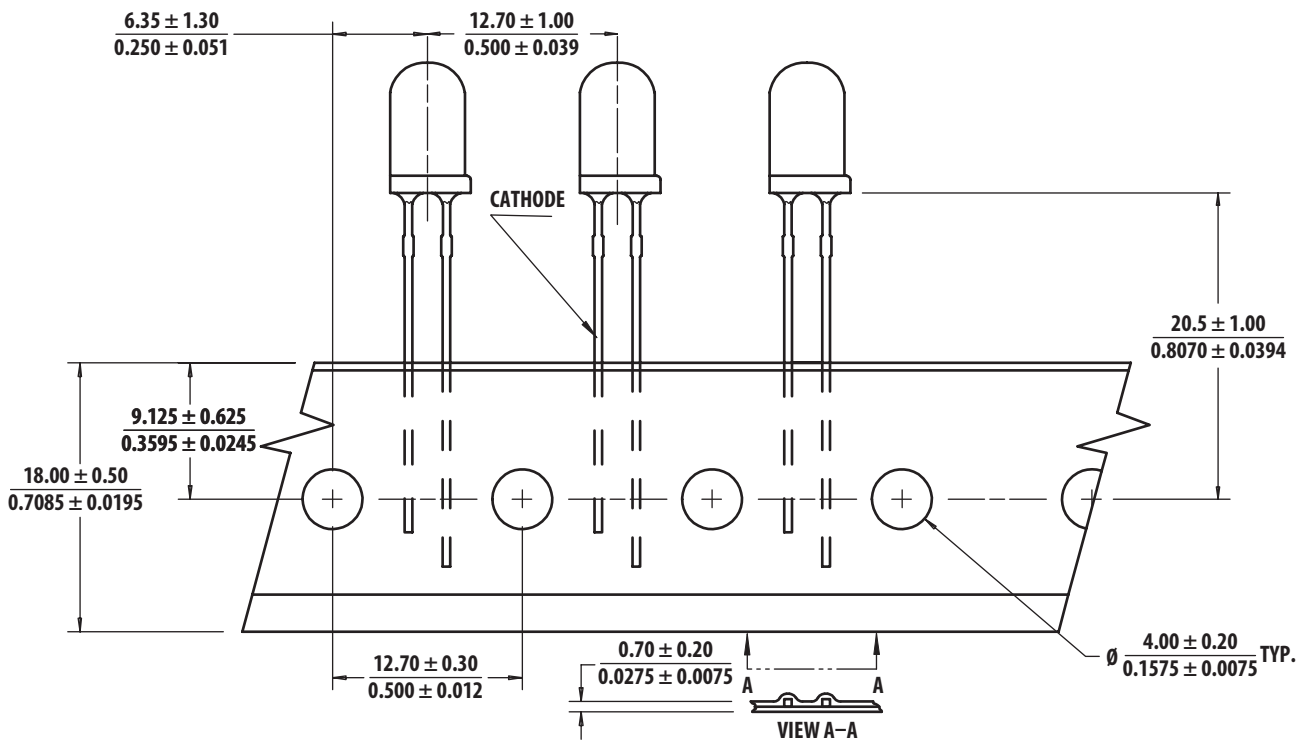

Note: The ammo-packs drawing is applicable for packaging option -DD & -ZZ and regardless standoff or non-standoff

## Packaging Box for Ammo Packs

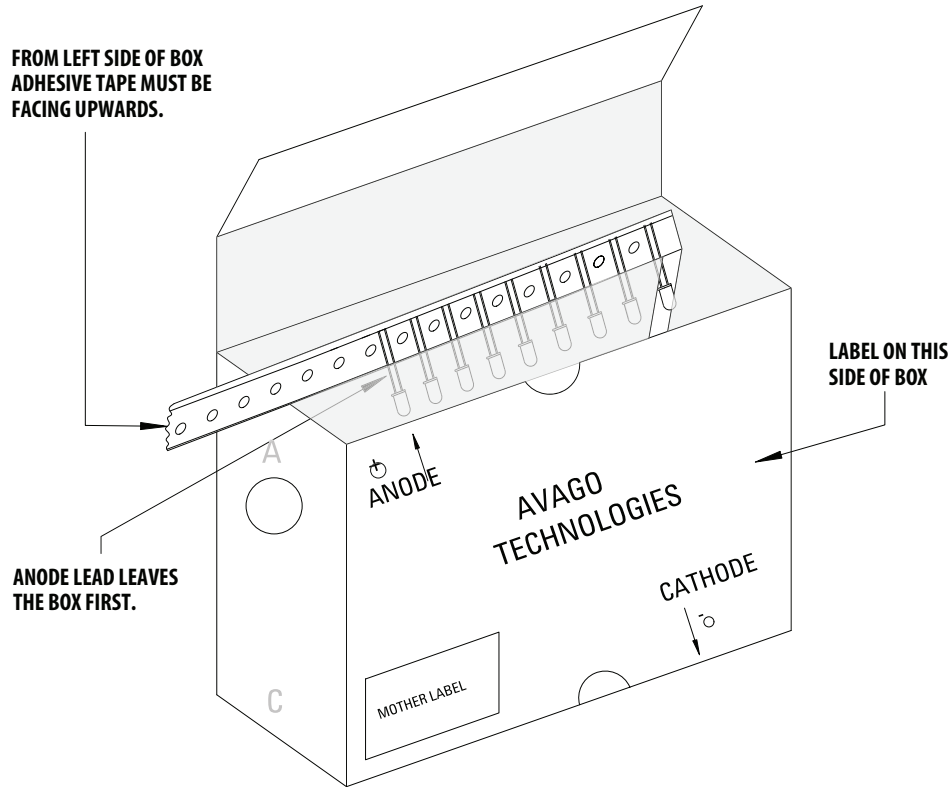







Note: For InGaN device, the ammo pack packaging box contain ESD logo

## Packaging Label

(i) Avago Mother Label: (Available on packaging box of ammo pack and shipping box)

|   |   |
|---|---|
| <b>AVAGO</b><br>TECHNOLOGIES                                |   |
| STANDARD LABEL LS0002<br>RoHS Compliant<br>e3 max temp 260C |   |
| (1P) Item: Part Number<br>[Barcode]                         | (Q) QTY: Quantity<br>[Barcode]          |
| (1T) Lot: Lot Number<br>[Barcode]                           | CAT: Intensity Bin<br>[Barcode]         |
| LPN:<br>[Barcode]   | BIN: Color Bin                          |
| (9D)MFG Date: Manufacturing Date<br>[Barcode]               |   |
| <hr/>   |   |
| (P) Customer Item:<br>[Barcode]                             |   |
| (V) Vendor ID:<br>[Barcode]                                 | (9D) Date Code: Date Code<br>[Barcode]  |
| <hr/>   |   |
| DeptID:<br>[Barcode]  | Made In: Country of Origin<br>[Barcode] |

(ii) Avago Baby Label (Only available on bulk packaging)

|   |   |   |  |
|---|---|---|--|
|  |   | RoHS Compliant  |  |
| <b>Lamps Baby Label</b>   |   | e3 max temp 260C  |  |
| (1P) PART #: Part Number  |  |   |  |
| (1T) LOT #: Lot Number  |  |   |  |
| (9D)MFG DATE: Manufacturing Date  | QUANTITY: Packing Quantity  |  |  |
| C/O: Country of Origin  |   |   |  |
| Customer P/N:   | CAT: Intensity Bin  |  |  |
| Supplier Code:  | BIN: Color Bin  |  |  |
|   | DATECODE: Date Code   |  |  |

**DISCLAIMER:** Avago's products and software are not specifically designed, manufactured or authorized for sale as parts, components or assemblies for the planning, construction, maintenence or direct operation of a nuclear facility or for use in medical devices or applications. Customer is solely responsible, and waives all rights to make claims against avago or its suppliers, for all loss, damage, expense or liability in connection with such use.

For product information and a complete list of distributors, please go to our web site: [www.avagotech.com](http://www.avagotech.com)

Компания «Life Electronics» занимается поставками электронных компонентов импортного и отечественного производства от производителей и со складов крупных дистрибьюторов Европы, Америки и Азии.

С конца 2013 года компания активно расширяет линейку поставок компонентов по направлению коаксиальный кабель, кварцевые генераторы и конденсаторы (керамические, пленочные, электролитические), за счёт заключения дистрибьюторских договоров

Мы предлагаем:

- Конкуренеспособные цены и скидки постоянным клиентам.
- Специальные условия для постоянных клиентов.
- Подбор аналогов.
- Поставку компонентов в любых объемах, удовлетворяющих вашим потребностям.
- Приемлемые сроки поставки, возможна ускоренная поставка.
- Доставку товара в любую точку России и стран СНГ.
- Комплексную поставку.
- Работу по проектам и поставку образцов.
- Формирование склада под заказчика.
- Сертификаты соответствия на поставляемую продукцию (по желанию клиента).
- Тестирование поставляемой продукции.
- Поставку компонентов, требующих военную и космическую приемку.
- Входной контроль качества.
- Наличие сертификата ISO.

В составе нашей компании организован Конструкторский отдел, призванный помогать разработчикам, и инженерам.

Конструкторский отдел помогает осуществить:

- Регистрацию проекта у производителя компонентов.
- Техническую поддержку проекта.
- Защиту от снятия компонента с производства.
- Оценку стоимости проекта по компонентам.
- Изготовление тестовой платы монтаж и пусконаладочные работы.



Тел: +7 (812) 336 43 04 (многоканальный)

Email: [org@lifeelectronics.ru](mailto:org@lifeelectronics.ru)