

5 Amp Output Current IGBT Gate Drive Optocoupler with 100 kV/ μ s Noise Immunity

Data Sheet

Description

The ACNW3430 contains an LED, which is optically coupled to an integrated circuit with a power output stage. This optocoupler is ideally suited for driving IGBTs and power MOSFETs used in motor control inverter applications. The 100 kV/ μ s noise immunity prevents erroneous drive in noisy industrial environments. The voltage and high peak output current supplied by this optocoupler make it ideally suited for driving IGBTs directly. The ACNW3430 has the highest insulation voltage of $V_{IORM} = 1414 V_{peak}$ in the IEC/EN/DIN EN 60747-5-5.

CAUTION It is advised that normal static precautions be taken in handling and assembly of this component to prevent damage and/or degradation that may be induced by ESD.

Features

- 5.0 A maximum peak output current
- Rail-to-rail output voltage
- UVLO with V_E reference for negative power supply
- 150 ns maximum propagation delay
- 90 ns maximum propagation delay difference
- LED current input with hysteresis
- 100 kV/ μ s minimum Common Mode Rejection (CMR) at $V_{CM} = 1500 V$
- $I_{CC} = 5.0 mA$ maximum supply current
- Under Voltage Lock-Out Protection (UVLO) with Hysteresis
- Wide Operating V_{CC} Range: 15 V to 30 V
- Industrial Temperature Range: $-40^\circ C$ to $105^\circ C$
- Safety Approval
 - UL Recognized 5000 V_{RMS} for 1min.
 - CSA
 - IEC/EN/DIN EN 60747-5-5 $V_{IORM} = 1414 V_{peak}$

Applications

- IGBT/MOSFET gate drive
- AC and brushless DC motor drives
- Renewable energy inverters
- Industrial inverters
- Switching power supplies

Functional Diagram

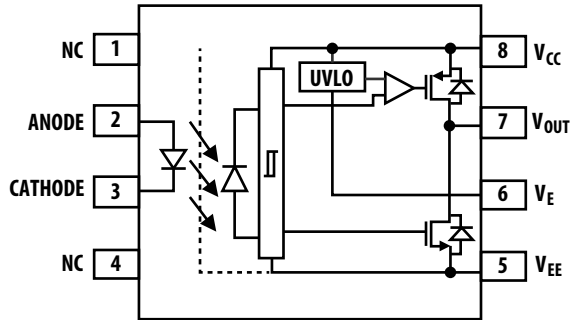

Design Notes: A 1- μ F bypass capacitor must be connected between pins V_{CC} and V_{EE} .

Truth Table – ACNW3430

LED	$V_{CC} - V_{EE}$ "POSITIVE GOING" (i.e., TURN-ON)	$V_{CC} - V_{EE}$ "NEGATIVE GOING" (i.e., TURN-OFF)	VO
OFF	0 V to 30 V	0 V to 30 V	LOW
ON	0 V to 11.9 V	0 V to 10.9 V	LOW
ON	11.9 V - to 13.2 V	10.9 V to 12.2 V	TRANSITION
ON	13.2 V – to 30 V	12.2 V to 30V	HIGH

Ordering Information

ACNW3430 is UL Recognized with 5000 V_{RMS} for 1 minute per UL1577.

Part Number	Option	Package	Gull Wing Surface Mount	Tape and Reel	IEC/EN/DIN EN 60747-5-5	Quantity
	RoHS Compliant					
ACNW3430	-000E	400mil DIP-8			X	42 per tube
	-300E		X		X	42 per tube
	-500E		X	X	X	750 per reel

To order, choose a part number from the part number column and combine with the desired option from the option column to form an order entry.

Example 1:

ACNW3430-500E to order product of 400mil DIP Gull Wing Surface Mount package in Tape and Reel packaging with IEC/EN/DIN EN 60747-5-5 Safety Approval in RoHS compliant.

Example 2:

ACNW3430-000E to order product of 400mil DIP package in Tube packaging and RoHS compliant.

Option data sheets are available. Contact your Avago sales representative or authorized distributor for information.

Package Outline Drawings

ACNW3430 Outline Drawing (8-pin Wide Body Package / 400mil DIP)

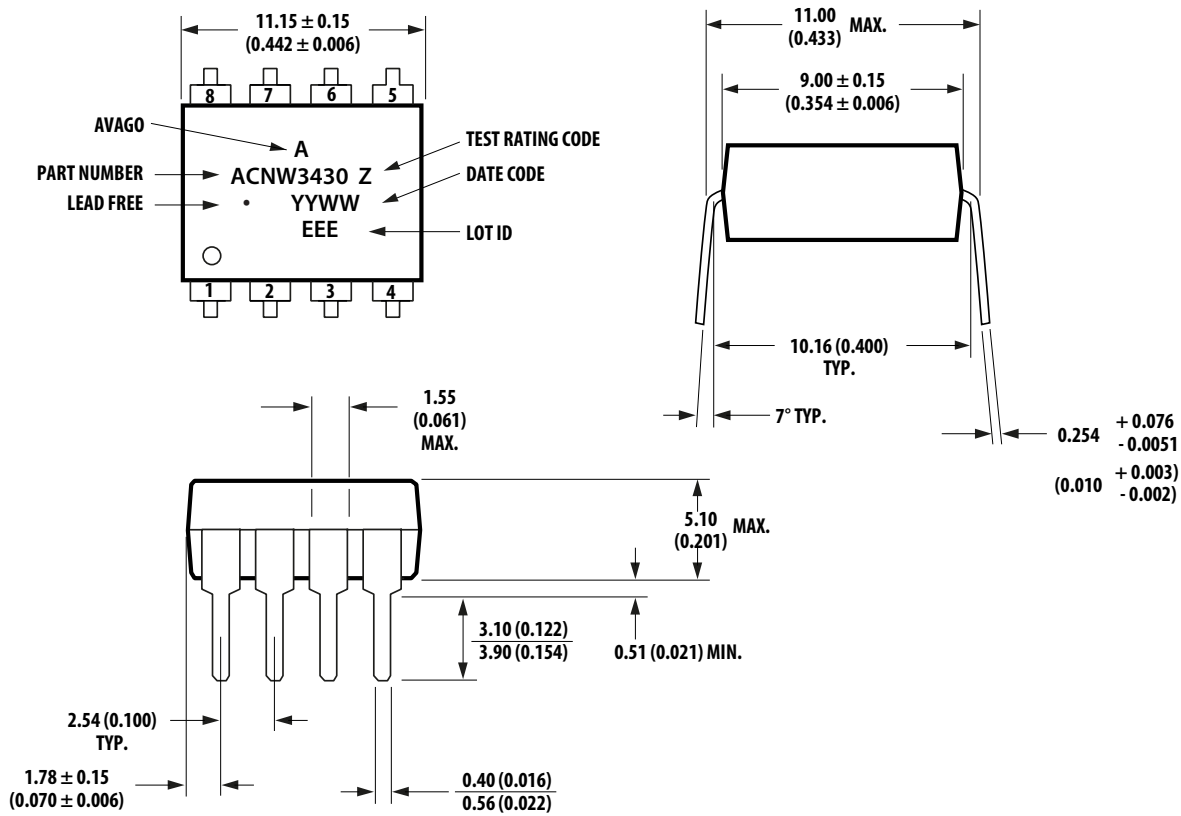

Dimensions in millimeters (inches).

NOTE Floating Lead Protrusion is 0.25 mm (10 mils) maximum.

ACNW3430 Gull Wing Surface Mount Option 300 Outline Drawing

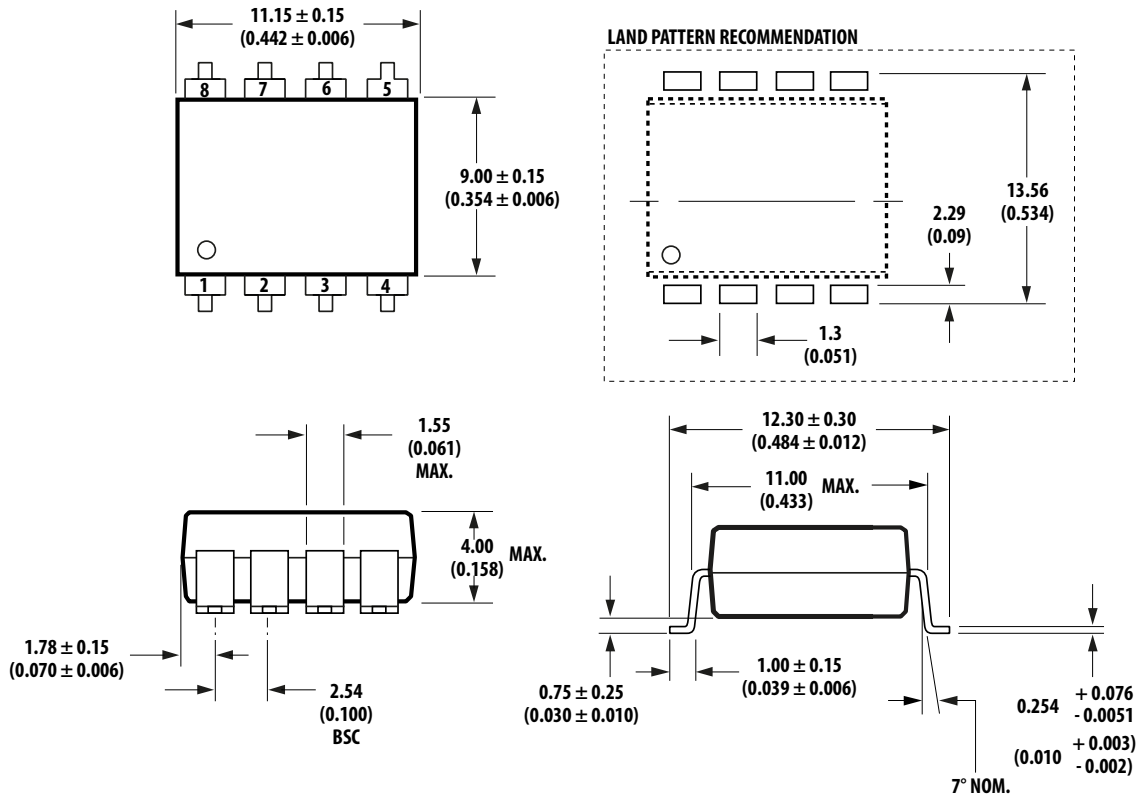

Dimensions in millimeters (inches).

Lead coplanarity = 0.10 mm (0.004 inches).

NOTE Floating lead protrusion is 0.25 mm (10 mils) maximum.

Recommended Pb-Free IR Profile

Recommended reflow condition as per JEDEC Standard, J-STD-020 (latest revision). Non-Halide Flux should be used.

Regulatory Information

The ACNW3430 is approved by the following organizations:

UL	Recognized under UL 1577, component recognition program up to $V_{ISO} = 5000 V_{RMS}$, File E55361
CSA	CSA Component Acceptance Notice #5, File CA 88324
IEC/EN/DIN EN 60747-5-5	Maximum Working Insulation Voltage $V_{IORM} = 1414 V_{peak}$

Table 1. IEC/EN/DIN EN 60747-5-5 Insulation Characteristics (see Note 1)

Description	Symbol	Characteristic	Unit
Installation classification per DIN VDE 0110/39, Table 1 for rated mains voltage $\leq 600 V_{RMS}$ for rated mains voltage $\leq 1000 V_{RMS}$		I – IV I – III	
Climatic Classification		40/105/21	
Pollution Degree (DIN VDE 0110/39)		2	
Maximum Working Insulation Voltage	V_{IORM}	1414	V_{peak}
Input to Output Test Voltage, Method b (see Note 1) $V_{IORM} \times 1.875 = V_{PR}$, 100% Production Test with $t_m = 1$ sec, Partial discharge < 5 pC	V_{PR}	2652	V_{peak}
Input to Output Test Voltage, Method a (see Note 1) $V_{IORM} \times 1.6 = V_{PR}$, Type and Sample Test, $t_m = 10$ sec, Partial discharge < 5 pC	V_{PR}	2262	V_{peak}
Highest Allowable Overvoltage (see Note 1) (Transient Overvoltage $t_{ini} = 60$ sec)	V_{IOTM}	8000	V_{peak}
Safety-limiting values – maximum values allowed in the event of a failure. Case Temperature Input Current Output Power	T_S $I_{S, INPUT}$ $P_{S, OUTPUT}$	150 400 800	$^{\circ}C$ mA mW
Insulation Resistance at T_S , $V_{IO} = 500$ V	R_S	$>10^9$	Ω

NOTE

1. Refer to IEC/EN/DIN EN 60747-5-5 Optoisolator Safety Standard section of the *Avago Regulatory Guide to Isolation Circuits*, AV02-2041EN for a detailed description of Method a and Method b partial discharge test profiles.
2. These optocouplers are suitable for “safe electrical isolation” only within the safety limit data. Maintenance of the safety data shall be ensured by means of protective circuits. Surface mount classification is Class A in accordance with CECC 00802.

Table 2. Insulation and Safety Related Specifications

Parameter	Symbol	ACNW3430	Units	Conditions
Minimum External Air Gap (Clearance)	L(101)	9.6	mm	Measured from input terminals to output terminals, shortest distance through air.
Minimum External Tracking (Creepage)	L(102)	10.0	mm	Measured from input terminals to output terminals, shortest distance path along body.
Minimum Internal Plastic Gap (Internal Clearance)		1.0	mm	Through insulation distance conductor to conductor, usually the straight line distance thickness between the emitter and detector.
Tracking Resistance (Comparative Tracking Index)	CTI	> 200	V	DIN IEC 112/VDE 0303 Part 1
Isolation Group		IIIa		Material Group (DIN VDE 0110, 1/89, Table 1)

NOTE All Avago data sheets report the creepage and clearance inherent to the optocoupler component itself. These dimensions are needed as a starting point for the equipment designer when determining the circuit insulation requirements. However, once mounted on a printed circuit board, minimum creepage and clearance requirements must be met as specified for individual equipment standards. For creepage, the shortest distance path along the surface of a printed circuit board between the solder fillets of the input and output leads must be considered (the recommended Land Pattern does not necessarily meet the minimum creepage of the device). There are recommended techniques, such as grooves and ribs, that may be used on a printed circuit board to achieve desired creepage and clearances. Creepage and clearance distances will also change depending on factors, such as pollution degree and insulation level.

Table 3. Absolute Maximum Ratings

Parameter	Symbol	Min.	Max.	Units	Note
Storage Temperature	T_S	-55	125	°C	
Operating Temperature	T_A	-40	105	°C	
Average Input Current	$I_{F(AVG)}$		25	mA	a
Peak Transient Input Current (<1 ms pulse width, 300pps)	$I_{F(TRAN)}$		1	A	
Reverse Input Voltage	V_R		5	V	
"High" Peak Output Current	$I_{OH(PEAK)}$		5.0	A	b
"Low" Peak Output Current	$I_{OL(PEAK)}$		5.0	A	b
Total Output Supply Voltage	$(V_{CC} - V_{EE})$	-0.5	35	V	
Negative Output Supply Voltage	$(V_E - V_{EE})$	-0.5	15	V	
Positive Output Supply Voltage	$(V_{CC} - V_E)$	-0.5	$35 - (V_E - V_{EE})$	V	
Output Voltage	$V_{O(PEAK)}$	-0.5	V_{CC}	V	
Output IC Power Dissipation	P_O		800	mW	c
Total Power Dissipation	P_T		850	mW	d

- Derate linearly above 70 °C free-air temperature at a rate of 0.3 mA/°C.
- Maximum pulse width = 10 μ s. This value is intended to allow for component tolerances for designs with I_{OH} peak minimum = 4 A. See the Applications section for additional details on limiting I_{OH} peak.
- Derate linearly above 85 °C free-air temperature at a rate of 20 mW/°C.
- Derate linearly above 85 °C free-air temperature at a rate of 21.25 mW/°C. The maximum LED junction temperature should not exceed 125 °C.

Table 4. Recommended Operating Conditions

Parameter	Symbol	Min	Max.	Units	Note
Operating Temperature	T_A	-40	105	°C	
Output Supply Voltage	$(V_{CC} - V_{EE})$	15	30	V	
Negative Output Supply Voltage	$(V_E - V_{EE})$	0	15	V	
Positive Output Supply Voltage	$(V_{CC} - V_E)$	15	$30 - (V_E - V_{EE})$	V	
Input Current (ON)	$I_{F(ON)}$	8	12	mA	
Input Voltage (OFF)	$V_{F(OFF)}$	-3.6	0.5	V	

Table 5. Electrical Specifications (DC)

All typical values are at $T_A = 25\text{ }^\circ\text{C}$, $V_{CC} - V_E = 15\text{ V}$, $V_E - V_{EE} = 15\text{ V}$. All minimum and maximum specifications are at recommended operating conditions ($T_A = -40\text{ }^\circ\text{C}$ to $105\text{ }^\circ\text{C}$, $I_{F(ON)} = 8\text{ mA}$ to 12 mA , $V_{F(OFF)} = -3.6\text{ V}$ to 0.5 V , $V_{CC} - V_E = 15\text{ V}$, $V_E - V_{EE} = 15\text{ V}$), unless otherwise noted.

Parameter	Symbol	Min.	Typ.	Max.	Units	Test Conditions	Fig.	Note
High Level Peak Output Current	I_{OH}	-4.0	-7.5		A	$V_{CC} - V_O = 15$	2, 3	a
Low Level Peak Output Current	I_{OL}	4.0	6.2		A	$V_O - V_{EE} = 15$	5, 6	a
High Output Transistor RDS(ON)	$R_{DS,OH}$	0.5	1.2	2.1	Ω	$I_{OH} = 4\text{ A}$	7	b
Low Output Transistor RDS(ON)	$R_{DS,OL}$	0.2	0.65	1.3	Ω	$I_{OL} = -4\text{ A}$	8	b
High Level Output Voltage	V_{OH}	$V_{CC} - 0.3$	$V_{CC} - 0.12$		V	$I_O = -100\text{ mA}$	1	c, d
High Level Output Voltage	V_{OH}		V_{CC}		V	$I_O = 0\text{ mA}$, $I_F = 10\text{ mA}$		
Low Level Output Voltage	V_{OL}		0.09	0.25	V	$I_O = 100\text{ mA}$	4	
High Level Output Supply Current (V_{CC})	I_{CCH}		3	5	mA	$I_F = 10\text{ mA}$	9	
Low Level Output Supply Current (V_{CC})	I_{CCL}		3	5	mA	$V_F = 0\text{ V}$	9	
V_E High Level Output Supply Current	I_{EH}	-1.3	-0.9		mA	$I_F = 10\text{ mA}$	10	
V_E Low Level Output Supply Current	I_{EL}	-1.0	-0.7		mA	$V_F = 0\text{ V}$	10	
Threshold Input Current Low to High	I_{FLH}	0.50	2.5	6	mA	$V_O > 5\text{ V}$	11, 12	
Threshold Input Voltage High to Low	V_{FHL}	0.5			V			
Input Forward Voltage	V_F	1.20	1.45	1.85	V	$I_F = 10\text{ mA}$		
Temperature Coefficient of Input Forward Voltage	$\Delta V_F / \Delta T_A$		-1.5		mV/ $^\circ\text{C}$	$I_F = 10\text{ mA}$		
Input Reverse Breakdown Voltage	BV_R	5			V	$I_R = 100\text{ mA}$		
Input Capacitance	C_{IN}		23		pF	$f = 1\text{ MHz}$, $V_F = 0\text{ V}$		
UVLO Threshold	V_{UVLO+}	11.9	12.6	13.2	V	$V_O > 5\text{ V}$, $I_F = 10\text{ mA}$		
	V_{UVLO-}	10.9	11.6	12.2				
UVLO Hysteresis	$UVLO_{HYS}$		1.0		V			

- Maximum pulse width = 10 ms.
- Output is sourced at -4.0 A/4.0 A with a maximum pulse width = 10 μs .
- In this test, V_{OH} is measured with a dc load current. When driving capacitive loads, V_{OH} will approach V_{CC} as I_{OH} approaches zero amps.
- Maximum pulse width = 1 ms.

Table 6. Switching Specifications (AC)

All typical values are at $T_A = 25\text{ }^\circ\text{C}$, $V_{CC} - V_E = 15\text{ V}$, $V_E - V_{EE} = 15\text{ V}$. All minimum and maximum specifications are at recommended operating conditions ($T_A = -40\text{ }^\circ\text{C}$ to $105\text{ }^\circ\text{C}$, $I_{F(ON)} = 8$ to 12 mA , $V_{F(OFF)} = -3.6\text{ V}$ to 0.5 V , $V_{CC} - V_E = 15\text{ V}$, $V_E - V_{EE} = 15\text{ V}$), unless otherwise noted.

Parameter	Symbol	Min.	Typ.	Max.	Units	Test Conditions	Fig.	Note
Propagation Delay Time to High Output Level	t_{PLH}	50	75	150	ns	$R_G = 7.5\ \Omega$, $C_G = 25\text{ nF}$, $f = 10\text{ kHz}$, Duty Cycle = 50%, $I_F = 10\text{ mA}$,	13, 14, 17	
Propagation Delay Time to Low Output Level	t_{PHL}	50	68	150	ns			
Pulse Width Distortion	PWD			80	ns		17	a
Propagation Delay Difference Between Any Two Parts	PDD ($t_{PHL} - t_{PLH}$)	-90		90	ns		17	b
Propagation Delay Skew	t_{PSK}			80	ns		17	c
Rise Time	t_R		20	50	ns		15, 17	
Fall Time	t_F		10	30	ns			
Output High Level Common Mode Transient Immunity	$ CM_H $	100			kV/ μs	$T_A = 25\text{ }^\circ\text{C}$, $I_F = 10\text{ mA}$, $V_{CM} = 1500\text{ V}$,	18	d, e
Output Low Level Common Mode Transient Immunity	$ CM_L $	100			kV/ μ	$T_A = 25\text{ }^\circ\text{C}$, $V_F = 0\text{ V}$, $V_{CM} = 1500\text{ V}$		d, f

- Pulse Width Distortion (PWD) is defined as $|t_{PHL} - t_{PLH}|$ for any given device.
- The difference between t_{PHL} and t_{PLH} between any two ACNW3430 parts under the same test condition.
- t_{PSK} is equal to the worst case difference in t_{PHL} or t_{PLH} that will be seen between units at any given temperature and specified test conditions.
- Pin 1 and 4 need to be connected to LED common. Split resistor network in the ratio 1:1 with $178\ \Omega$ at the anode and $178\ \Omega$ at the cathode.
- Common mode transient immunity in the high state is the maximum tolerable dV_{CM}/dt of the common mode pulse, V_{CM} , to assure that the output will remain in the high state (i.e., $V_O > 15.0\text{ V}$).
- Common mode transient immunity in a low state is the maximum tolerable dV_{CM}/dt of the common mode pulse, V_{CM} , to assure that the output will remain in a low state (i.e., $V_O < 1.0\text{ V}$).

Table 7. Package Characteristics

All typical values are at $T_A = 25^\circ\text{C}$. All minimum/maximum specifications are at recommended operating conditions, unless otherwise noted.

Parameter	Symbol	Min.	Typ.	Max.	Units	Test Conditions	Fig.	Note
Input-Output Momentary Withstand Voltage ^a	V_{ISO}	5000			V_{RMS}	RH < 50%, t = 1 min., $T_A = 25^\circ\text{C}$		b, c
Input-Output Resistance	R_{I-O}		10^{12}		Ω	$V_{I-O} = 500 V_{DC}$		c
Input-Output Capacitance	C_{I-O}		0.5		pF	f = 1 MHz		
LED-to-Ambient Thermal Resistance	R_{11}		139		$^\circ\text{C}/\text{W}$	Thermal Model in Application Notes Below		d
LED-to-Detector Thermal Resistance	R_{12}		25.3					
Detector-to-LED Thermal Resistance	R_{21}		40.2					
Detector-to-Ambient Thermal Resistance	R_{22}		87.5					

- The Input-Output Momentary Withstand Voltage is a dielectric voltage rating that should not be interpreted as an input-output continuous voltage rating. For the continuous voltage rating, refer to your equipment level safety specification or Avago Technologies Application Note 1074, *Optocoupler Input-Output Endurance Voltage*.
- In accordance with UL1577, each optocoupler is proof tested by applying an insulation test voltage $\geq 6000 V_{RMS}$ for 1 second (leakage detection current limit, $I_{I-O} \leq 5 \mu\text{A}$).
- The device is considered to be a two-terminal device: pins 1, 2, 3, and 4 shorted together and pins 5, 6, 7, and 8 shorted together.
- The device was mounted on a high conductivity test board as per JEDEC 51-7.

Figure 1 V_{OH} vs. Temperature

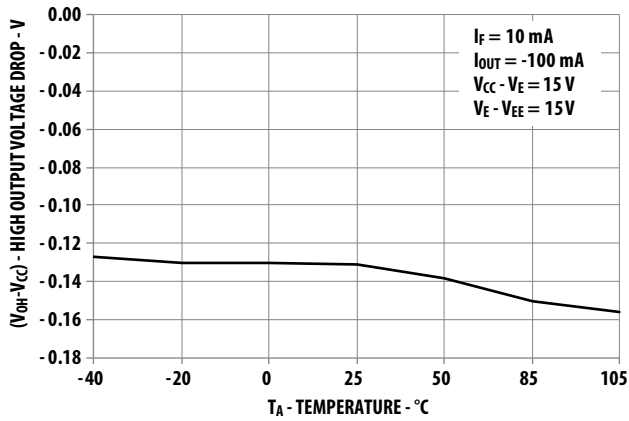

Figure 2 I_{OH} vs. Temperature

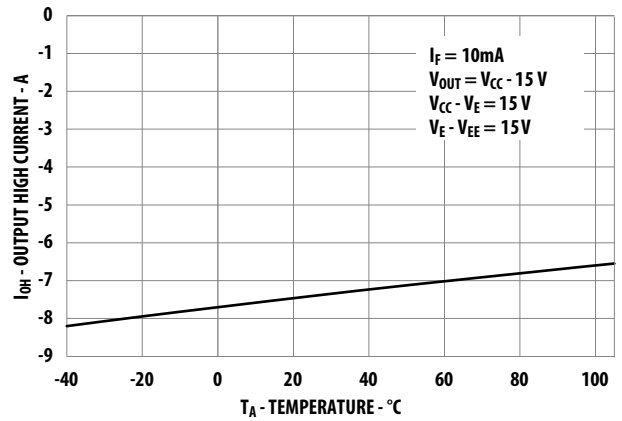

Figure 3 I_{OH} vs. V_{OH}

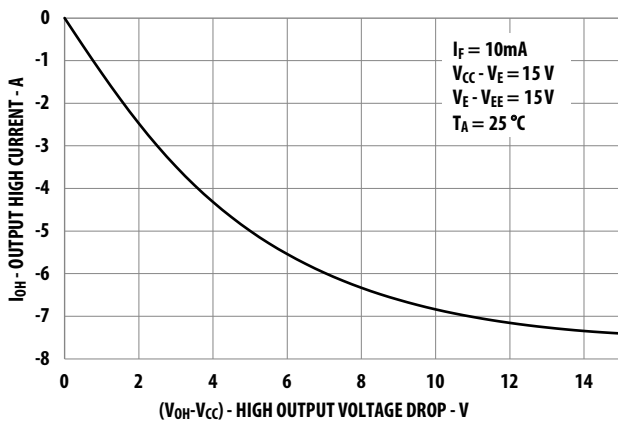

Figure 4 V_{OL} vs. Temperature

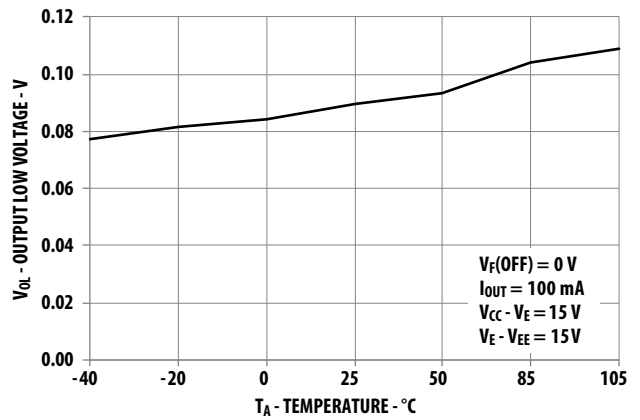

Figure 5 I_{OL} vs. Temperature

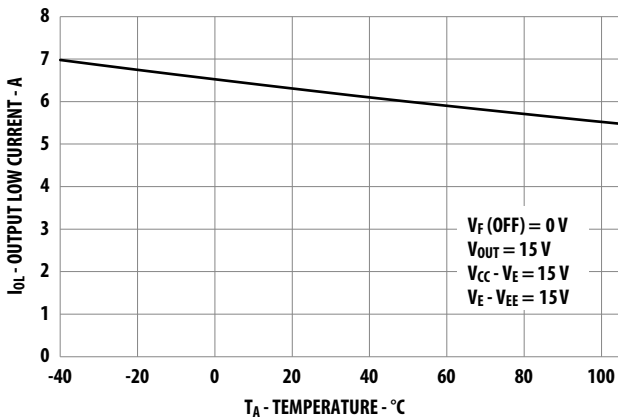

Figure 6 I_{OL} vs. V_{OL}

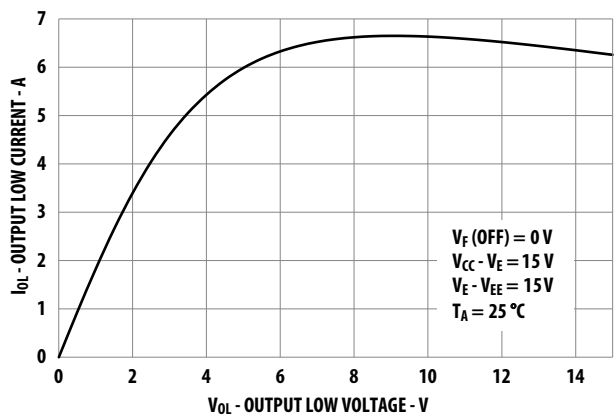

Figure 7 $R_{DS,OH}$ vs. Temperature

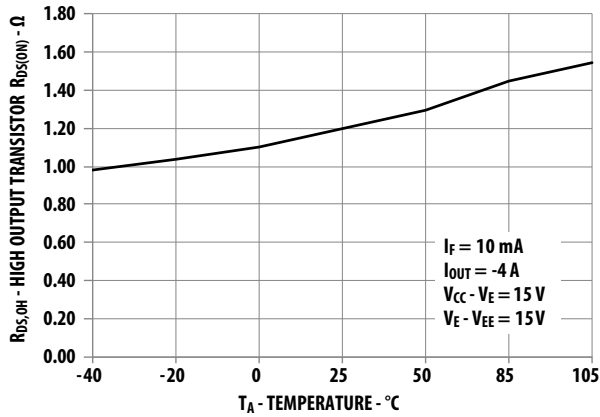

Figure 8 $R_{DS,OL}$ vs. Temperature

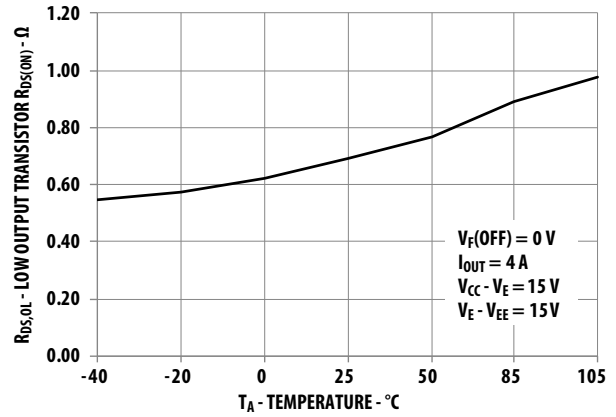

Figure 9 I_{CC} vs. Temperature

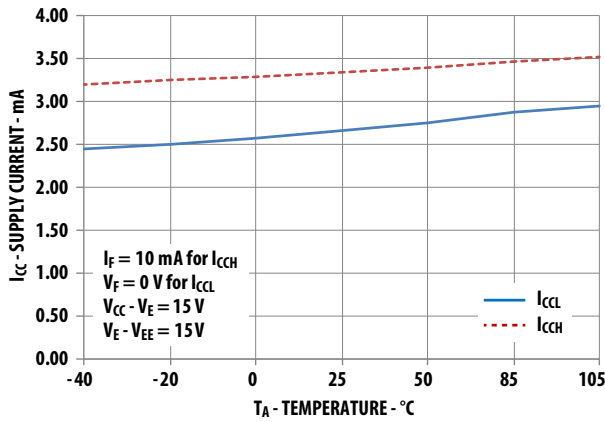

Figure 10 I_E vs. Temperature

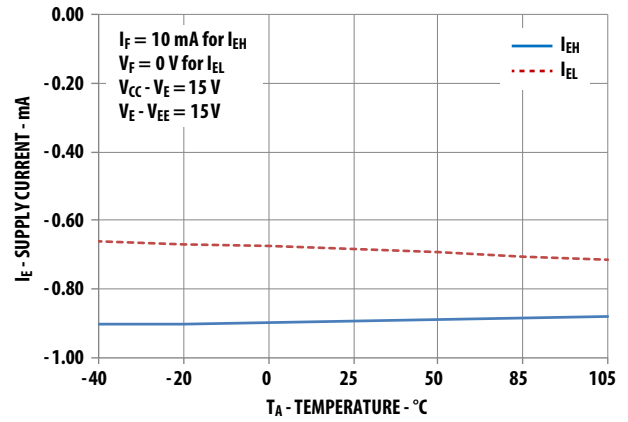

Figure 11 I_{FLH} Hysteresis

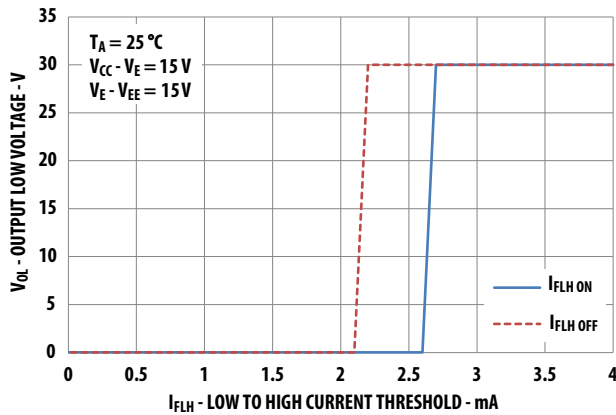

Figure 12 I_{FLH} vs. Temperature

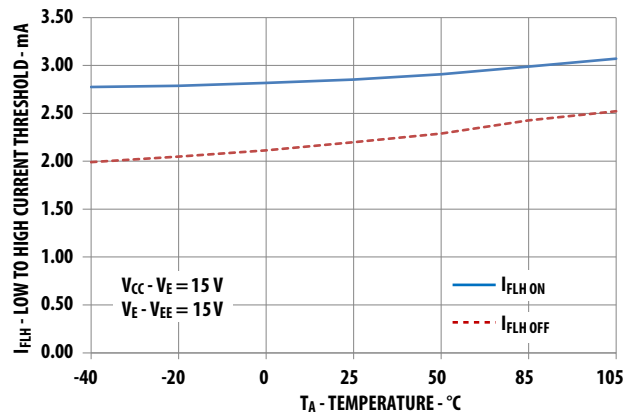

Figure 13 Propagation Delay vs. I_F

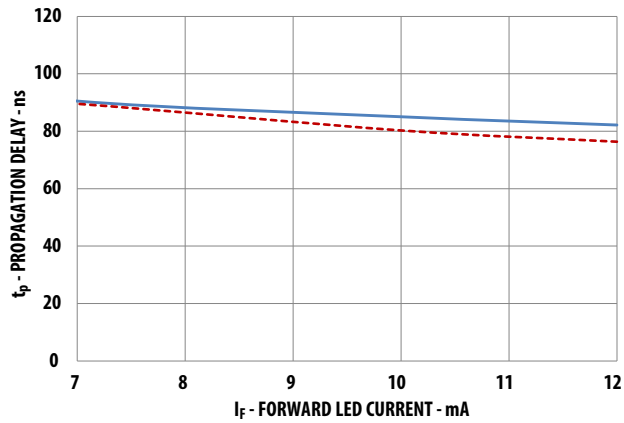

Figure 14 Propagation Delay vs. Temperature

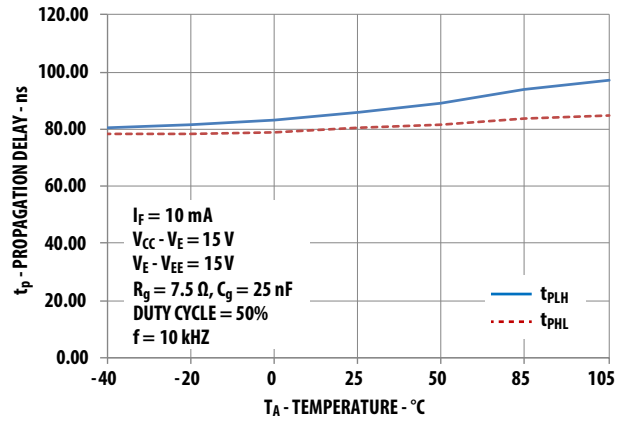

Figure 15 Rise and Fall Time vs. Temperature

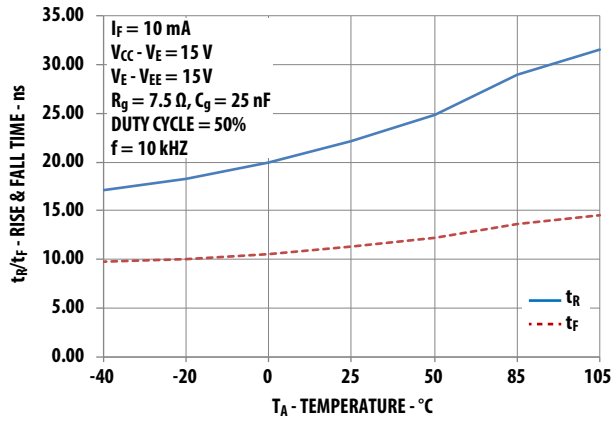

Figure 16 Input Current vs. Forward Voltage

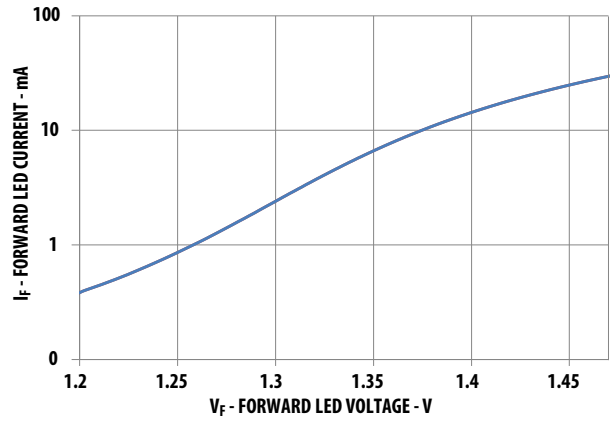

Figure 17 t_{PLH} , t_{PHL} , PWD PDD, t_{PSK} , t_r and t_f Test Circuit and Waveforms

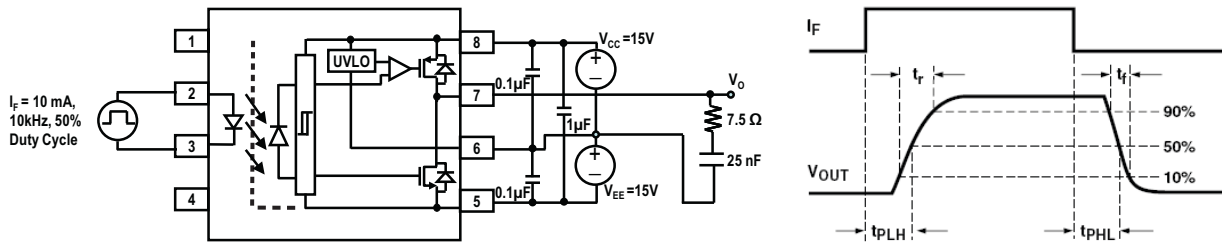
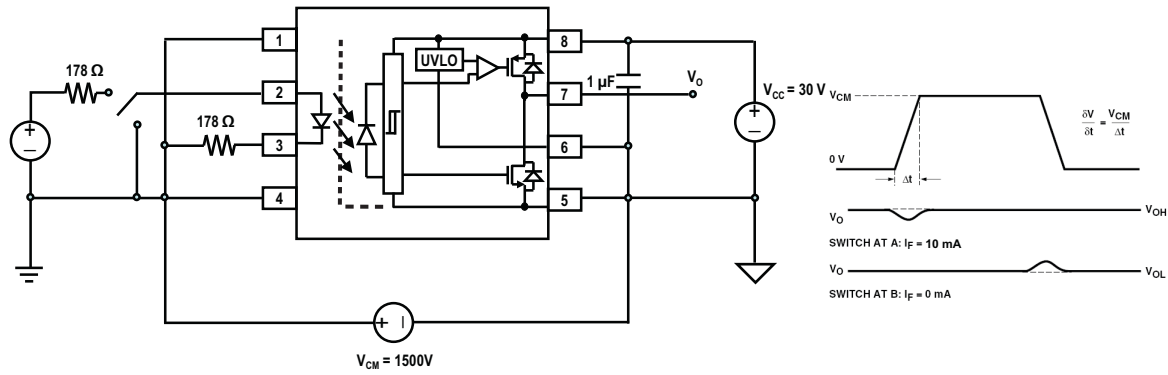

Figure 18 CMR Test Circuit with Split Resistors Network and Waveforms



Application Information

Product Overview Description

The ACNW3430 is an optically isolated power output stage capable of driving IGBT or power MOSFET. Based on BCDMOS technology, this gate drive optocoupler delivers higher peak output current, better rail-to-rail output voltage performance and faster speed than the previous generation products.

The high peak output current and short propagation delay are needed for fast IGBT switching to reduce dead time and improve system overall efficiency. Rail-to-rail output voltage ensures that the MOSFET's gate voltage is driven to the optimum intended level with no power loss across the MOSFET. This helps the designer lower the system power which is suitable for bootstrap power supply operation.

The ACNW3430 has a V_E pin that allows of use negative power supply without affecting the UVLO monitoring the positive power supply. It has very high CMR (common mode rejection) rating which allows the microcontroller and the MOSFET to operate at very large common mode noise found in industrial motor drives and other power switching applications. The input is driven by direct LED current and has a hysteresis that prevents output oscillation if insufficient LED driving current is applied. This will eliminates the need of additional Schmitt trigger circuit at the input LED.

Recommended Application Circuit

The recommended application circuit shown in Figure 19 illustrates a typical gate drive implementation using the ACNW3430.

The supply bypass capacitors provide the large transient currents necessary during a switching transition. Because of the transient nature of the charging currents, a low current (5.0 mA) power supply will be enough to power the device. The split resistors (in the ratio of 1:1) across the LED will provide a high CMR response by providing a balanced resistance network across the LED. Connect pin 1 and pin 4 to LED common.

The gate resistor R_G serves to limit gate charge current and controls the IGBT switching times.

In PC board design, care should be taken to avoid routing the IGBT's collector or emitter traces close to the ACNW3430 input as this can result in unwanted coupling of transient signals into ACNW3430 and degrade performance.

Figure 19 Recommended Application Circuit with Split Resistors LED Drive

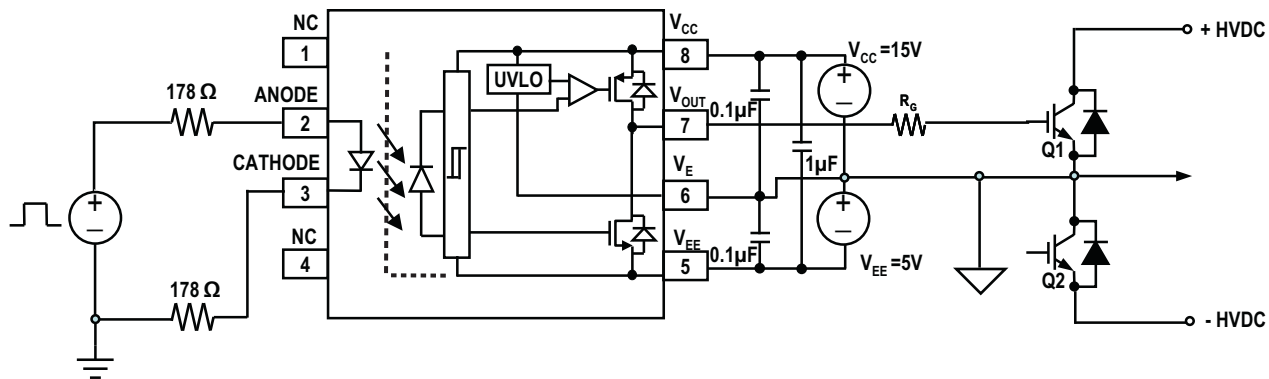

Thermal Model for ACNW3430 400mil DIP-8 Package Optocoupler

Definitions:

- R_{11} : Junction to Ambient Thermal Resistance of LED due to heating of LED
 R_{12} : Junction to Ambient Thermal Resistance of LED due to heating of Detector (Output IC)
 R_{21} : Junction to Ambient Thermal Resistance of Detector (Output IC) due to heating of LED.
 R_{22} : Junction to Ambient Thermal Resistance of Detector (Output IC) due to heating of Detector (Output IC).
 P_1 : Power dissipation of LED (W).
 P_2 : Power dissipation of Detector / Output IC (W).
 T_1 : Junction temperature of LED (C).
 T_2 : Junction temperature of Detector (C).
 T_A : Ambient temperature.

Ambient Temperature: Junction to Ambient Thermal Resistances were measured approximately 1.25 cm above the optocoupler at ~23 °C in still air.

Thermal Resistance	°C/W
R_{11}	139
R_{12}	25.3
R_{21}	40.2
R_{22}	87.5

This thermal model assumes that an 8-pin single-channel plastic package optocoupler is soldered into a 7.62 cm × 7.62 cm printed circuit board (PCB) per JEDEC standards. The temperature at the LED and Detector junctions of the optocoupler can be calculated using the following equations.

$$T_1 = (R_{11} * P_1 + R_{12} * P_2) + T_A \text{ -- (1)}$$

$$T_2 = (R_{21} * P_1 + R_{22} * P_2) + T_A \text{ -- (2)}$$

For product information and a complete list of distributors, please go to our web site:

www.avagotech.com

Avago Technologies and the A logo are trademarks of Avago Technologies in the United States and other countries. All other brand and product names may be trademarks of their respective companies.

Data subject to change. Copyright © 2015–2016 Avago Technologies. All Rights Reserved.

AV02-4666EN – June 30, 2016

AVAGO
TECHNOLOGIES



Компания «Life Electronics» занимается поставками электронных компонентов импортного и отечественного производства от производителей и со складов крупных дистрибьюторов Европы, Америки и Азии.

С конца 2013 года компания активно расширяет линейку поставок компонентов по направлению коаксиальный кабель, кварцевые генераторы и конденсаторы (керамические, пленочные, электролитические), за счёт заключения дистрибьюторских договоров

Мы предлагаем:

- Конкурентоспособные цены и скидки постоянным клиентам.
- Специальные условия для постоянных клиентов.
- Подбор аналогов.
- Поставку компонентов в любых объемах, удовлетворяющих вашим потребностям.
- Приемлемые сроки поставки, возможна ускоренная поставка.
- Доставку товара в любую точку России и стран СНГ.
- Комплексную поставку.
- Работу по проектам и поставку образцов.
- Формирование склада под заказчика.
- Сертификаты соответствия на поставляемую продукцию (по желанию клиента).
- Тестирование поставляемой продукции.
- Поставку компонентов, требующих военную и космическую приемку.
- Входной контроль качества.
- Наличие сертификата ISO.

В составе нашей компании организован Конструкторский отдел, призванный помогать разработчикам, и инженерам.

Конструкторский отдел помогает осуществить:

- Регистрацию проекта у производителя компонентов.
- Техническую поддержку проекта.
- Защиту от снятия компонента с производства.
- Оценку стоимости проекта по компонентам.
- Изготовление тестовой платы монтаж и пусконаладочные работы.



Тел: +7 (812) 336 43 04 (многоканальный)

Email: org@lifeelectronics.ru