

Selection Guide

Part No.	Dice	Lens Type	Iv (ucd) [1] @ 10mA		Description
			Min.	Typ.	
TA20-11SYKWA	Super Bright Yellow (AlGaInP)	White Diffused	88000	160000	Column Anode
			*21000	*51000	

Notes:

- Luminous intensity/ luminous Flux: +/-15%.
- *Luminous intensity value is traceable to the CIE127-2007 compliant national standards.

Electrical / Optical Characteristics at TA=25°C

Symbol	Parameter	Device	Typ.	Max.	Units	Test Conditions
λ_{peak}	Peak Wavelength	Super Bright Yellow	590		nm	I _F =20mA
λ_D [1]	Dominant Wavelength	Super Bright Yellow	590		nm	I _F =20mA
$\Delta\lambda_{1/2}$	Spectral Line Half-width	Super Bright Yellow	20		nm	I _F =20mA
C	Capacitance	Super Bright Yellow	20		pF	V _F =0V;f=1MHz
V _F [2]	Forward Voltage	Super Bright Yellow	2.0	2.5	V	I _F =20mA
I _R	Reverse Current	Super Bright Yellow		10	uA	V _R =5V

Notes:

- Wavelength: +/-1nm.
- Forward Voltage: +/-0.1V.
- Wavelength value is traceable to the CIE127-2007 compliant national standards.
- Excess driving current and/or operating temperature higher than recommended conditions may result in severe light degradation or premature failure.

Absolute Maximum Ratings at TA=25°C

Parameter	Super Bright Yellow	Units
Power dissipation	75	mW
DC Forward Current	30	mA
Peak Forward Current [1]	175	mA
Reverse Voltage	5	V
Operating / Storage Temperature	-40°C To +85°C	
Lead Solder Temperature[2]	260°C For 3-5 Seconds	

Notes:

- 1/10 Duty Cycle, 0.1ms Pulse Width.
- 2mm below package base.

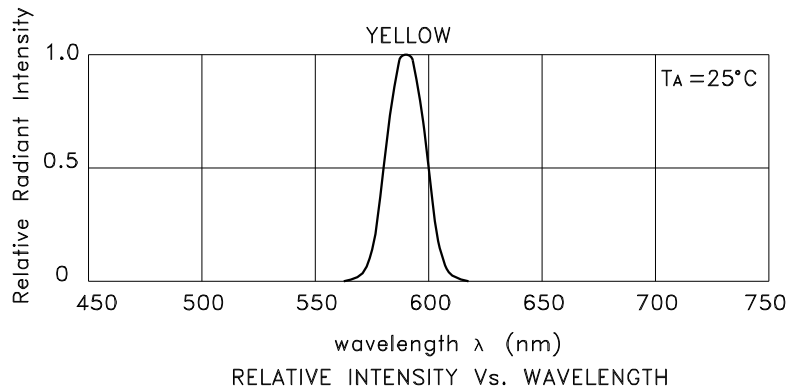

Super Bright Yellow TA20-11SYKWA

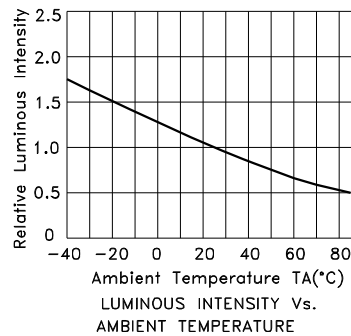
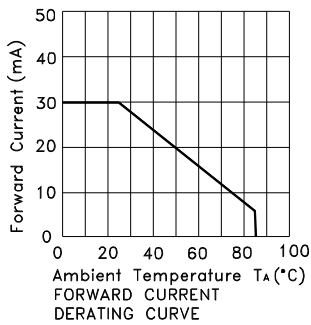
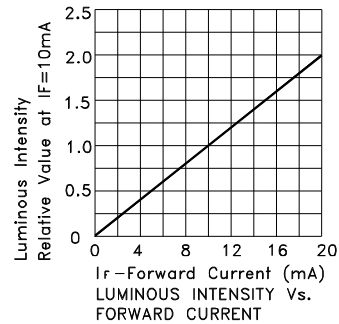
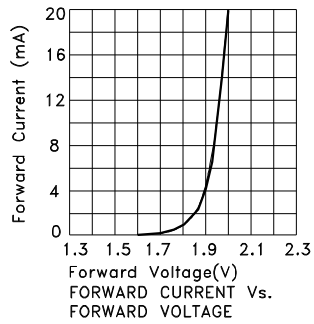

PACKING & LABEL SPECIFICATIONS

TA20-11SYKWA

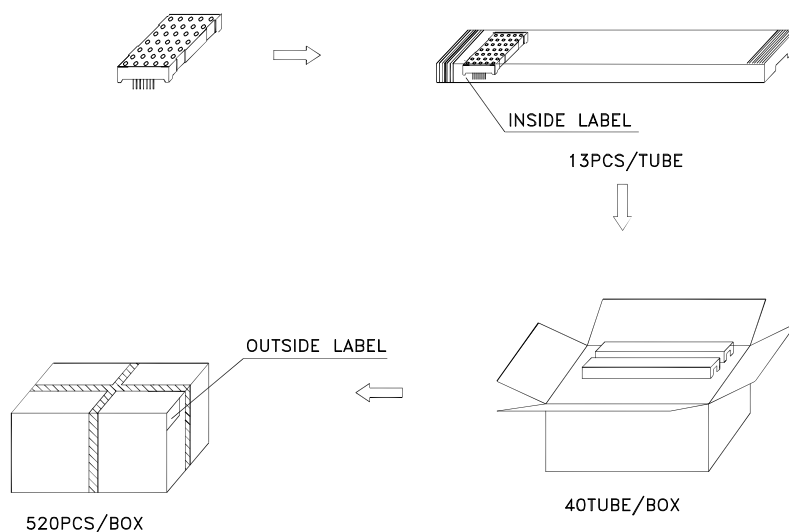

Inside Label On IC-tube

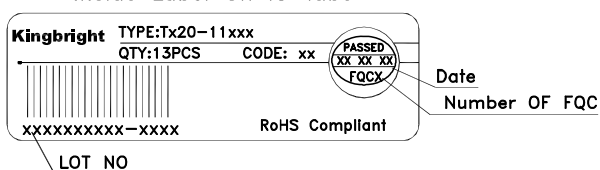

Outside Label On Box

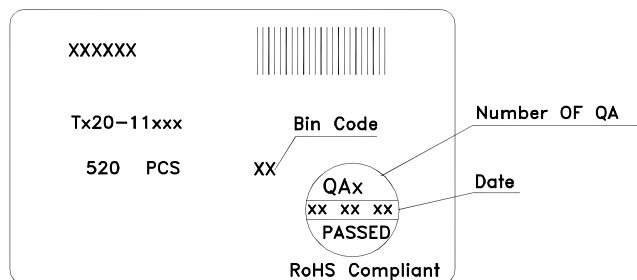

Terms and conditions for the usage of this document

1. The information included in this document reflects representative usage scenarios and is intended for technical reference only.
2. The part number, type, and specifications mentioned in this document are subject to future change and improvement without notice. Before production usage customer should refer to the latest datasheet for the updated specifications.
3. When using the products referenced in this document, please make sure the product is being operated within the environmental and electrical limits specified in the datasheet. If customer usage exceeds the specified limits, Kingbright will not be responsible for any subsequent issues.
4. The information in this document applies to typical usage in consumer electronics applications. If customer's application has special reliability requirements or have life-threatening liabilities, such as automotive or medical usage, please consult with Kingbright representative for further assistance.
5. The contents and information of this document may not be reproduced or re-transmitted without permission by Kingbright.
6. All design applications should refer to Kingbright application notes available at <http://www.KingbrightUSA.com/ApplicationNotes>

THROUGH HOLE DISPLAY MOUNTING METHOD

Lead Forming

Do not bend the component leads by hand without proper tools.

The leads should be bent by clinching the upper part of the lead firmly such that the bending force is not exerted on the plastic body.

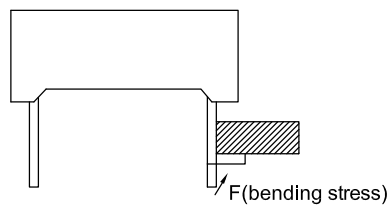

Not Recommended

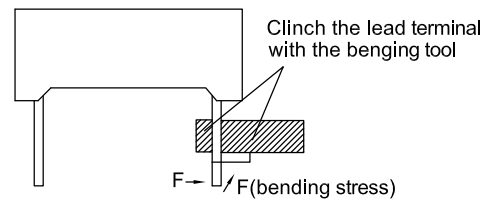

Recommended

Installation

- 1.The installation process should not apply stress to the lead terminals.
- 2.When inserting for assembly, ensure the terminal pitch matches the substrate board's hole pitch to prevent spreading or pinching the lead terminals.

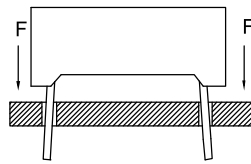

Not Recommended

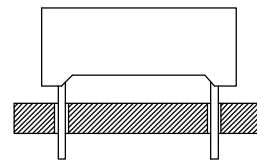

Recommended

- 3.The component shall be placed at least 5mm from edge of PCB to avoid damage caused excessive heat during wave soldering.

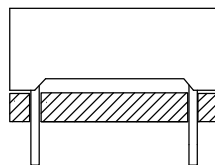

Not Recommended

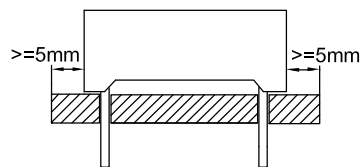

Recommended

Recommended Wave Soldering Profiles:

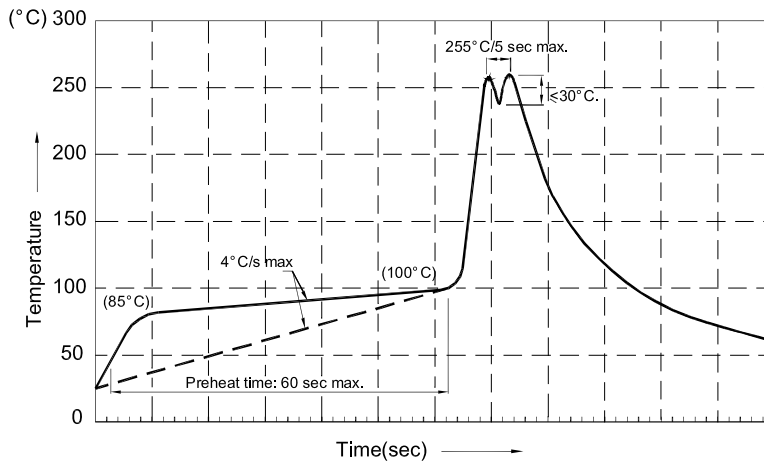

Notes:

- 1.Recommend pre-heat temperature of 105° C or less (as measured with a thermocouple attached to the LED pins) prior to immersion in the solder wave with a maximum solder bath temperature of 260° C
- 2.Peak wave soldering temperature between 245° C ~ 255° C for 3 sec (5 sec max).
- 3.Do not apply stress to the epoxy resin while the temperature is above 85° C.
- 4.Fixtures should not incur stress on the component when mounting and during soldering process.
- 5.SAC 305 solder alloy is recommended.
- 6.No more than one wave soldering pass.
- 7.During wave soldering, the PCB top-surface temperature should be kept below 105° C.

Soldering General Notes:

- 1.Through-hole displays are incompatible with reflow soldering.
- 2.If components will undergo multiple soldering processes, or other processes where the components may be subjected to intense heat, please check with Kingbright for compatibility.

CLEANING

- 1.Mild "no-clean" fluxes are recommended for use in soldering.
- 2.If cleaning is required, Kingbright recommends to wash components with water only.
Do not use harsh organic solvents for cleaning because they may damage the plastic parts .
- 3.The cleaning process should take place at room temperature and the devices should not be washed for more than one minute.
- 4.When water is used in the cleaning process, immediately remove excess moisture from the component with forced-air drying afterwards.

CIRCUIT DESIGN NOTES

- 1.Protective current-limiting resistors may be necessary to operate the LEDs within the specified range.
- 2.LEDs mounted in parallel should each be placed in series with its own current-limiting resistor.

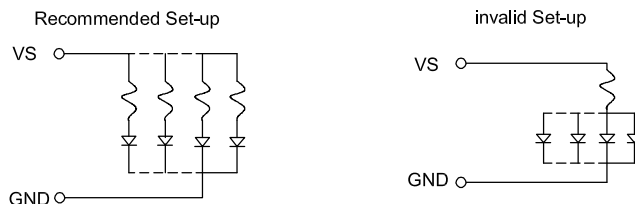

3. The driving circuit should be designed to protect the LED against reverse voltages and transient voltage spikes when the circuit is powered up or shut down.
4. The safe operating current should be chosen after considering the maximum ambient temperature of the operating environment.
5. Prolonged reverse bias should be avoided, as it could cause metal migration, leading to an increase in leakage current or causing a short circuit.

Компания «Life Electronics» занимается поставками электронных компонентов импортного и отечественного производства от производителей и со складов крупных дистрибьюторов Европы, Америки и Азии.

С конца 2013 года компания активно расширяет линейку поставок компонентов по направлению коаксиальный кабель, кварцевые генераторы и конденсаторы (керамические, пленочные, электролитические), за счёт заключения дистрибьюторских договоров

Мы предлагаем:

- Конкурентоспособные цены и скидки постоянным клиентам.
- Специальные условия для постоянных клиентов.
- Подбор аналогов.
- Поставку компонентов в любых объемах, удовлетворяющих вашим потребностям.
- Приемлемые сроки поставки, возможна ускоренная поставка.
- Доставку товара в любую точку России и стран СНГ.
- Комплексную поставку.
- Работу по проектам и поставку образцов.
- Формирование склада под заказчика.
- Сертификаты соответствия на поставляемую продукцию (по желанию клиента).
- Тестирование поставляемой продукции.
- Поставку компонентов, требующих военную и космическую приемку.
- Входной контроль качества.
- Наличие сертификата ISO.

В составе нашей компании организован Конструкторский отдел, призванный помогать разработчикам, и инженерам.

Конструкторский отдел помогает осуществить:

- Регистрацию проекта у производителя компонентов.
- Техническую поддержку проекта.
- Защиту от снятия компонента с производства.
- Оценку стоимости проекта по компонентам.
- Изготовление тестовой платы монтаж и пусконаладочные работы.



Тел: +7 (812) 336 43 04 (многоканальный)

Email: org@lifeelectronics.ru