

DURA-CON

All-Plastic

Strip Connectors

Metal Shell

Mil-C-83513 Connectors

Terminal Blocks

Microedge

.050" D-microminiature



Cinch

Cinch Dura-Con™ connectors are designed for applications that require a rugged, durable, and high-performance interconnect. Dura-Con is the ideal connector for applications where weight and space must be kept to a minimum while maintaining maximum reliability. Miniaturized airborne electronics and data processing equipment, where shorter signal paths are needed, represent typical applications for these unique connectors.

The heart of the Dura-Con system is the Dura-Con pin contact. The Cinch Dura-Con pin contact is made from a precision miniature spring cable with a welded tip. The expanded cable provides seven spring members peripherally around the pin so that contact is maintained with the mating socket wall no matter what radial forces are applied. This spring may be flexed many times without any evidence of metal fatigue. Reliable mating is further ensured by protecting the pin contact in a tightly tolerated recessed cavity.

Cinch's family of Dura-Con connectors includes MIL-C-83513 Series connectors along with our own commercial equivalents. The commercial Dura-Con product line offers an expanded range of termination and hardware options for all-plastic and metal shell wire versions and right-angle and straight PC board mount "terminal blocks". Cinch also packages the Dura-Con contact in a very low profile plastic strip connector on .050" centers and in a line of high-density microminiature edge (Microedge) board connectors that meet the requirements of MIL-C-55302. Cinch has created a line of plastic and metal shell Dura-Con connector savers for very high mating cycle applications such as test equipment.

Termination Options:

Cinch offers the following termination methods for its Dura-Con connectors:

Insulated Wire - Insulated wire is crimped to the Dura-Con contacts then epoxy backpotted at the factory. Wire is available in standard lengths of 18, 24, 36, and 48 inches.

Uninsulated Wire - 24 AWG, gold-plated, uninsulated wire is crimped to the Dura-Con contact at the factory. Wire is available in standard lengths of 0.5, 1.0, and 2.0 inches. This option allows the user greater flexibility when installing the connector.

Solder Cup - For applications that require the lowest contact resistance, Cinch offers Dura-Con connectors with solder cups for termination by the user.



Dura-Con is a trademark of Cinch Connectors.

Custom Capabilities:

Standard Cinch Dura-Con connectors satisfy a wide variety of applications. Cinch's line of Dura-Con D-microminiature connectors is one of the most versatile in the industry. There are over 50,000 possible combinations of Cinch standard options such as connector type, size, materials, hardware, and termination.

When special application requirements arise, Cinch Dura-Con connectors take this versatility to the next level. Whether specific needs entail new variations of simple end-to-end connector assemblies or more complex and intricate harness assemblies, Cinch Connector Division has the state-of-the-art engineering resources and research facilities in place to meet your needs. Cinch approaches your business with a well-defined goal: to ensure the integrity of your design and to execute our contribution to it in a responsible, cost-effective manner. This philosophy has led Cinch to a position of industry leadership.

For complete information regarding the total capabilities of the Dura-Con connector series, or for custom application assistance, contact your nearest Cinch Connectors sales office.



5

Dura-Con
High Reliability
All-Plastic

.050" (1.27mm) Density
 Solder Cup/Wire
 D-Microminiature



FEATURES

- Both plug and socket available in 9, 15, 21, 25, 31, 37, and 51 positions.
- Termination styles - solder cup, gold-plated solid wire, and insulated stranded wire.
- Several styles of mounting hardware are available for cable-to-cable, cable-to-board mount, and cable-to-panel mount applications.
- High-performance Dura-Con twist-pin contact.
- Economical all-plastic shell for lightweight applications where no shielding is required.
- Meets requirements of MIL-C-83513 except where noted.



MATERIALS

Insulator: UL94V-0 rated glass-filled polyester
Contacts: Pins - Copper alloy, Sockets - Copper alloy (machined)
Contact Plating: .000050 in gold

ENVIRONMENTAL

Operating Temperature: -55° C to +135° C

ELECTRICAL

Current Rating: 3 Amps maximum
Withstanding Voltage: 600 VAC RMS @ sea level
Contact Resistance: 8 milliohms maximum change

MECHANICAL

Individual Contact: 6 oz. (170.40 g) maximum insertion;
 0.5 oz. (14.20 g) minimum withdrawal
Mating / Unmating Force: See table

| No. of Contacts | Maximum Mating Force | | Minimum Unmating Force | |
|-----------------|----------------------|-------|------------------------|-----|
| | Lb. | Kg | Lb. | Kg |
| 9 | 5.63 | 2.56 | .28 | .13 |
| 15 | 9.38 | 4.26 | .47 | .21 |
| 21 | 13.13 | 5.96 | .66 | .30 |
| 25 | 15.63 | 7.10 | .78 | .35 |
| 31 | 19.38 | 8.80 | .97 | .44 |
| 37 | 23.13 | 10.50 | 1.16 | .53 |
| 51 | 31.88 | 14.47 | 1.59 | .72 |

Contact Arrangements
 (Face view of pin insulator)
 (Use reverse order for socket)



Ordering Information



* - Indicates Cinch std. option.

** - See p. 5-12 for std. hardware dims. See p. 5-13 for non-std. hardware & p. 5-31 for Mil spec. hardware both sold separately.

*** - Length Tolerance: solid wire = $\pm 3/32"$, standard wire = $\pm 1/4"$.

Connector Dimensions - Plastic Shell

Plug



Socket



5

| No. of Contacts | A | | B Max. | | C | | D | | E | | F Max. | |
|-----------------|---------------|-------|--------|-------|------------------------------|-------|--------------|-------|--------------|------|--------|------|
| | ± .010 (.254) | | | | +.010 (.254) -.018 (.457) | | ±.005 (.127) | | ±.010 (.254) | | | |
| | in | mm | in | mm | in | mm | in | mm | in | mm | in | mm |
| 9 Plug | .778 | 19.76 | .292 | 7.42 | .398 | 10.11 | .565 | 14.35 | .208 | 5.28 | .173 | 4.39 |
| 9 Socket | .778 | 19.76 | .376 | 9.55 | .398 | 10.11 | .565 | 14.35 | .208 | 5.28 | .173 | 4.39 |
| 15 Plug | .928 | 23.57 | .442 | 11.23 | .548 | 13.92 | .715 | 18.16 | .208 | 5.28 | .173 | 4.39 |
| 15 Socket | .928 | 23.57 | .526 | 13.36 | .548 | 13.92 | .715 | 18.16 | .208 | 5.28 | .173 | 4.39 |
| 21 Plug | 1.078 | 27.38 | .592 | 15.04 | .698 | 17.73 | .865 | 21.97 | .208 | 5.28 | .173 | 4.39 |
| 21 Socket | 1.078 | 27.38 | .676 | 17.17 | .698 | 17.73 | .865 | 21.97 | .208 | 5.28 | .173 | 4.39 |
| 25 Plug | 1.178 | 29.92 | .692 | 17.58 | .798 | 20.27 | .965 | 24.51 | .208 | 5.28 | .173 | 4.39 |
| 25 Socket | 1.178 | 29.92 | .776 | 19.71 | .798 | 20.27 | .965 | 24.51 | .208 | 5.28 | .173 | 4.39 |
| 31 Plug | 1.328 | 33.73 | .842 | 21.39 | .948 | 24.08 | 1.115 | 28.32 | .208 | 5.28 | .173 | 4.39 |
| 31 Socket | 1.328 | 33.73 | .926 | 23.52 | .948 | 24.08 | 1.115 | 28.32 | .208 | 5.28 | .173 | 4.39 |
| 37 Plug | 1.478 | 37.54 | .992 | 25.20 | 1.098 | 27.89 | 1.265* | 32.13 | .208 | 5.28 | .173 | 4.39 |
| 37 Socket | 1.478 | 37.54 | 1.076 | 27.33 | 1.098 | 27.89 | 1.265* | 32.13 | .208 | 5.28 | .173 | 4.39 |
| 51 Plug | 1.428 | 36.27 | .942 | 23.93 | 1.048 | 26.62 | 1.215 | 30.86 | .250 | 6.35 | .220 | 5.59 |
| 51 Socket | 1.428 | 36.27 | 1.026 | 26.06 | 1.048 | 26.62 | 1.215 | 30.86 | .250 | 6.35 | .220 | 5.59 |

Panel Mounting Dimensions

Pin and socket,
rear mounted



Pin and socket,
front mounted



Pin, front mounted
Socket, rear mounted



Panel Cutout Dimensions



Figure 1. Front Mounting



Figure 2. Rear Mounting



Figure 3. Edgeboard Mounting

| No. of Contacts | Figure Number | A | | B | | C | |
|-----------------|---------------|------------------------|------------------------|------------------------|------------------------|------------------------|------------------------|
| | | +0.004 -0.000 in | (.101) (.000) mm | +0.004 -0.000 in | (.101) (.000) mm | +0.005 -0.000 in | (.127) (.000) mm |
| 9 | 1 | .408 | 10.36 | .172 | 4.37 | .570 | 14.48 |
| | 2 | .373 | 9.47 | .216 | 5.49 | .570 | 14.48 |
| | 3 | - | - | - | - | .570 | 14.48 |
| 15 | 1 | .558 | 14.17 | .172 | 4.37 | .720 | 18.29 |
| | 2 | .523 | 13.28 | .216 | 5.49 | .720 | 18.29 |
| | 3 | - | - | - | - | .720 | 18.29 |
| 21 | 1 | .708 | 17.98 | .172 | 4.37 | .870 | 22.10 |
| | 2 | .674 | 17.12 | .216 | 5.49 | .870 | 22.10 |
| | 3 | - | - | - | - | .870 | 22.10 |
| 25 | 1 | .808 | 20.52 | .172 | 4.37 | .970 | 24.64 |
| | 2 | .774 | 19.66 | .216 | 5.49 | .970 | 24.64 |
| | 3 | - | - | - | - | .970 | 24.64 |
| 31 | 1 | .958 | 24.33 | .172 | 4.37 | 1.120 | 28.45 |
| | 2 | .924 | 23.47 | .216 | 5.49 | 1.120 | 28.45 |
| | 3 | - | - | - | - | 1.120 | 28.45 |
| 37 | 1 | 1.108 | 28.14 | .172 | 4.37 | 1.270 | 32.26 |
| | 2 | 1.074 | 27.28 | .216 | 5.49 | 1.270 | 32.26 |
| | 3 | - | - | - | - | 1.270 | 32.26 |
| 51 | 1 | 1.058 | 26.87 | .215 | 5.46 | 1.220 | 30.99 |
| | 2 | 1.024 | 26.01 | .259 | 6.58 | 1.220 | 30.99 |
| | 3 | - | - | - | - | 1.220 | 30.99 |

Dura-Con
High Reliability
Metal Shell

.050" (1.27mm) Density
 Solder Cup/Wire
 D-Microminiature



FEATURES

- Both plug and socket available in 9, 15, 21, 25, 31, 37, 51, and 100 positions.
- Several styles of mounting are available for cable-to-cable, cable-to-panel mount, and cable-to-board mount.
- Aluminum shell provides extra strength and EMI/RFI shielding capability. Plating options available.
- Silicone elastomer compression interfacial seal protects contacts from moisture and humidity and isolates contacts from each other and the metal shell.
- Meets requirements of MIL-C-83513 except where noted.
- Rugged twist-pin contacts resistant to shock and vibration make metal shell Dura-Con an excellent choice for harsh environments such as airborne or space applications.



MATERIALS

Insulator: UL94V-0 rated glass-filled polyester or diallyl phthalate
Contacts: Pins - Copper alloy, Sockets - Copper alloy (machined)
Contact Plating: .000050 in gold
Shell: Aluminum alloy
Shell Plating: Yellow chromate over cadmium (std.) or electroless nickel

ENVIRONMENTAL

Operating Temperature: -55°C to +135°C

ELECTRICAL

Current Rating: 3 Amps maximum
Withstanding Voltage: 600 VAC RMS @ sea level
Contact Resistance: 8 milliohms maximum

MECHANICAL

Individual Contact: 6 oz. (170.40 g) maximum insertion;
 0.5 oz. (14.20 g) minimum withdrawal
Mating / Unmating Force: See table

| No. of Contacts | Maximum Mating Force | | Minimum Unmating Force | |
|-----------------|----------------------|-------|------------------------|------|
| | Lb. | Kg | Lb. | Kg |
| 9 | 5.63 | 2.56 | .28 | .13 |
| 15 | 9.38 | 4.26 | .47 | .21 |
| 21 | 13.13 | 5.96 | .66 | .30 |
| 25 | 15.63 | 7.10 | .78 | .35 |
| 31 | 19.38 | 8.80 | .97 | .44 |
| 37 | 23.13 | 10.50 | 1.16 | .53 |
| 51 | 31.88 | 14.47 | 1.59 | .72 |
| 100 | 62.50 | 28.38 | 3.13 | 1.42 |

Contact Arrangements

(Face view of pin insert)
 (Use reverse order for socket side)



Ordering Information



* - Indicates Cinch std. option.

** - See p. 5-12 for std. hardware dims. See p. 5-13 for non-std. hardware & p. 5-31 for Mil spec. hardware both sold separately.

*** - Length Tolerance: solid wire = ± 3/32", standard wire = ± 1/4".

Connector Dimensions - Metal Shell



| No. of Contacts | A | | B Max. | | C | | D | | E | | F Max. | |
|-----------------|---------------|-------|--------|-------|--------------------------------|-------|---------------|-------|---------------|------|--------|------|
| | ± .010 (.254) | | | | + .010 (.254) - .018 (.457) | | ± .005 (.127) | | ± .010 (.254) | | | |
| | in | mm | in | mm | in | mm | in | mm | in | mm | in | mm |
| 9 Plug | .775 | 19.68 | .333 | 8.46 | .390 | 9.91 | .565 | 14.35 | .298 | 7.57 | .270 | 6.86 |
| 9 Socket | .775 | 19.68 | .396 | 10.06 | .390 | 9.91 | .565 | 14.35 | .298 | 7.57 | .270 | 6.86 |
| 15 Plug | .925 | 23.50 | .483 | 12.27 | .540 | 13.72 | .715 | 18.16 | .298 | 7.57 | .270 | 6.86 |
| 15 Socket | .925 | 23.50 | .546 | 13.87 | .540 | 13.72 | .715 | 18.16 | .298 | 7.57 | .270 | 6.86 |
| 21 Plug | 1.075 | 27.30 | .633 | 16.08 | .690 | 17.53 | .865 | 21.97 | .298 | 7.57 | .270 | 6.86 |
| 21 Socket | 1.075 | 27.30 | .696 | 17.68 | .690 | 17.53 | .865 | 21.97 | .298 | 7.57 | .270 | 6.86 |
| 25 Plug | 1.175 | 29.84 | .733 | 18.62 | .790 | 20.07 | .965 | 24.51 | .298 | 7.57 | .270 | 6.86 |
| 25 Socket | 1.175 | 29.84 | .796 | 20.22 | .790 | 20.07 | .965 | 24.51 | .298 | 7.57 | .270 | 6.86 |
| 31 Plug | 1.325 | 33.66 | .883 | 21.16 | .940 | 23.88 | 1.115 | 28.32 | .298 | 7.57 | .270 | 6.86 |
| 31 Socket | 1.325 | 33.66 | .946 | 24.03 | .940 | 23.88 | 1.115 | 28.32 | .298 | 7.57 | .270 | 6.86 |
| 37 Plug | 1.475 | 37.46 | 1.033 | 26.24 | 1.090 | 27.69 | 1.265 | 32.13 | .298 | 7.57 | .270 | 6.86 |
| 37 Socket | 1.475 | 37.46 | 1.096 | 27.84 | 1.090 | 27.69 | 1.265 | 32.13 | .298 | 7.57 | .270 | 6.86 |
| 51 Plug | 1.425 | 36.20 | .983 | 24.97 | 1.040 | 26.42 | 1.215 | 30.86 | .341 | 8.66 | .310 | 7.87 |
| 51 Socket | 1.425 | 36.20 | 1.046 | 26.57 | 1.040 | 26.42 | 1.215 | 30.86 | .341 | 8.66 | .310 | 7.87 |
| 100 Plug | 2.160 | 54.86 | 1.383 | 35.13 | 1.432 | 36.38 | 1.800 | 45.71 | .384 | 9.75 | .360 | 9.15 |
| 100 Socket | 2.160 | 54.86 | 1.446 | 36.73 | 1.432 | 36.38 | 1.800 | 45.71 | .384 | 9.75 | .360 | 9.15 |

Panel Mounting Dimensions

Pin and socket,
rear mounted



Pin and socket,
front mounted



Pin, front mounted
Socket, rear mounted

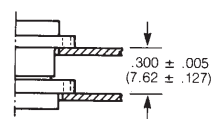

Panel Cutout Dimensions



| No. of Contacts | Figure Number | A | | B | | C | | D | |
|-----------------|---------------|------------------------|------------------------|------------------------|------------------------|------------------------|------------------------|------------------------|------------------------|
| | | +0.004 -0.000 in | (.101) (.000) mm | +0.004 -0.000 in | (.101) (.000) mm | +0.005 -0.000 in | (.127) (.000) mm | +0.005 -0.000 in | (1.27) (.000) mm |
| 9 | 1 | .408 | 10.36 | .270 | 6.86 | .570 | 14.48 | - | - |
| | 2 | .408 | 10.36 | .256 | 6.50 | .570 | 14.48 | .089 | 2.26 |
| | 3 | - | - | - | - | .570 | 14.48 | - | - |
| 15 | 1 | .558 | 14.17 | .270 | 6.86 | .720 | 18.29 | - | - |
| | 2 | .558 | 14.17 | .256 | 6.50 | .720 | 18.29 | .089 | 2.26 |
| | 3 | - | - | - | - | .720 | 18.29 | - | - |
| 21 | 1 | .708 | 17.98 | .270 | 6.86 | .870 | 22.10 | - | - |
| | 2 | .708 | 17.98 | .256 | 6.50 | .870 | 22.10 | .089 | 2.26 |
| | 3 | - | - | - | - | .870 | 22.10 | - | - |
| 25 | 1 | .808 | 20.52 | .270 | 6.86 | .970 | 24.64 | - | - |
| | 2 | .808 | 20.52 | .256 | 6.50 | .970 | 24.64 | .089 | 2.26 |
| | 3 | - | - | - | - | .970 | 24.64 | - | - |
| 31 | 1 | .958 | 24.33 | .270 | 6.86 | 1.120 | 28.45 | - | - |
| | 2 | .958 | 24.33 | .256 | 6.50 | 1.120 | 28.45 | .089 | 2.26 |
| | 3 | - | - | - | - | 1.120 | 28.45 | - | - |
| 37 | 1 | 1.108 | 28.14 | .270 | 6.86 | 1.270 | 32.26 | - | - |
| | 2 | 1.108 | 28.14 | .256 | 6.50 | 1.270 | 32.26 | .089 | 2.26 |
| | 3 | - | - | - | - | 1.270 | 32.26 | - | - |
| 51 | 1 | 1.058 | 26.87 | .315 | 8.00 | 1.220 | 30.99 | - | - |
| | 2 | 1.058 | 26.87 | .300 | 7.62 | 1.220 | 30.99 | .089 | 2.26 |
| | 3 | - | - | - | - | 1.220 | 30.99 | - | - |
| 100 | 1 | 1.450 | 36.84 | .361 | 9.17 | 1.805 | 45.86 | .117 | 2.97 |
| | 2 | 1.562 | 39.68 | .338 | 8.58 | 1.805 | 45.86 | .117 | 2.97 |
| | 3 | - | - | - | - | 1.805 | 45.86 | .117 | 2.97 |

Mounting Hardware
For Plastic & Metal Shell
Dura-Con Connectors



Float Mounting
Option "F"



Reversed Float Mounting
Option "R"



Standard Jackscrew
Option "K"



Low Profile Jackscrew
Option "L"



Removable Jackpost
Option "P"



Screwlock Kit

P/N: DCSL1
Purchased Separately

Jackpost - Rear Panel Mount
 (Purchased Separately)

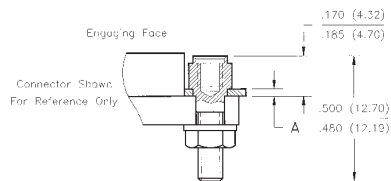

Jackpost Bushing
 (for rear panel mounting)

| Jackpost Part Number | Panel Thickness | | A Dimension | |
|----------------------|-----------------|-----|-------------|-----------|
| | in | mm | in | mm |
| DCJPRM094 | .094 | 2.5 | .092/.087 | 2.34/2.21 |
| DCJPRM063 | .063 | 1.6 | .061/.056 | 1.55/1.42 |
| DCJPRM047 | .047 | 1.2 | .047/.042 | 1.19/1.07 |
| DCJPRM031 | .031 | 0.8 | .030/.025 | 0.76/0.64 |

Panel Cutout Dimensions
 (Plug & Receptacle)



| Part Number (by Shell Size) | A | | B | | C | |
|--------------------------------|------------------------------|-------|------------------------------|------|--------------|-------|
| | +.004 (.101) -.000 (.000) | | +.004 (.101) -.000 (.000) | | ±.005 (.127) | |
| | in | mm | in | mm | in | mm |
| 9 | .398 | 10.11 | .249 | 6.32 | .565 | 14.35 |
| 15 | .548 | 13.92 | .249 | 6.32 | .715 | 18.16 |
| 21 | .698 | 17.73 | .249 | 6.32 | .865 | 21.97 |
| 25 | .798 | 20.27 | .249 | 6.32 | .965 | 24.51 |
| 31 | .948 | 24.08 | .249 | 6.32 | 1.115 | 28.34 |
| 37 | 1.098 | 27.89 | .249 | 6.32 | 1.265 | 32.13 |
| 51 | 1.048 | 26.62 | .292 | 7.42 | 1.215 | 30.86 |
| 100 | 1.448 | 36.78 | .336 | 8.53 | 1.800 | 45.72 |

Dura-Con High Reliability Metal Shell

.050" (1.27mm) Density
PCB Mount Terminal Block



FEATURES

- Plug & socket versions available in 9, 15, 21, 25, 31, 37, 51, and 100 positions.
- Flow-through design facilitates inspection and cleaning after soldering.
- All terminal block connectors use standard mounting hardware.
- Metal shell provides EMI/RFI shielding capability.
- Available in 3 styles: Straight mount, 90° right-angle mount, and 90° right-angle narrow profile mounting.
- Silicone elastomer interfacial seal protects contacts from moisture and isolates them from each other and from the metal shell.
- Meets requirements of MIL-C-83513.
- Choice of insulator materials.



MATERIALS

Insulator: UL94V-0 glass-filled polyester or diallyl phthalate
Contacts: Pins - Copper alloy, Sockets - Copper alloy (machined)
Contact Plating: .000050 in gold
Shell: Aluminum alloy
Shell Plating: Yellow chromate over cadmium (std.) or electroless nickel

ENVIRONMENTAL

Operating Temperature: -55°C to +135°C

ELECTRICAL

Current Rating: 3 Amps maximum
Withstanding Voltage: 600 VAC RMS @ sea level, 150 VAC @ 70,000 ft.
Contact Resistance: 8 milliohms maximum
Insulation Resistance: 1,000 megohms min between adjacent pins

MECHANICAL

Individual Contact: 6 oz. (170.40 g) maximum insertion force;
 0.5 oz. (14.20 g) minimum withdrawal force
Mating / Unmating Forces: See table

| No. of Contacts | Maximum Mating Force | | Minimum Unmating Force | |
|-----------------|----------------------|-------|------------------------|------|
| | Lb. | Kg | Lb. | Kg |
| 9 | 5.63 | 2.56 | .28 | .13 |
| 15 | 9.38 | 4.26 | .47 | .21 |
| 21 | 13.13 | 5.96 | .66 | .30 |
| 25 | 15.63 | 7.10 | .78 | .35 |
| 31 | 19.38 | 8.80 | .97 | .44 |
| 37 | 23.13 | 10.50 | 1.16 | .53 |
| 51 | 31.88 | 14.47 | 1.59 | .72 |
| 100 | 62.50 | 28.38 | 3.13 | 1.42 |

Contact Arrangements



Ordering Information



* For other options consult factory.

90° Termination



Recommended Board Layout



NOTE: For additional connector dimensions, see page 5-10.

| No. of Contacts | A | | B | | C | | F | |
|-----------------|-------|-------|-------|-------|-------|-------|------|-------|
| | in | mm | in | mm | in | mm | in | mm |
| 9 Plug | 1.390 | 35.31 | 1.150 | 29.21 | .565 | 14.35 | .465 | 11.81 |
| 9 Socket | 1.390 | 35.31 | 1.150 | 29.21 | .565 | 14.35 | .465 | 11.81 |
| 15 Plug | 1.540 | 39.12 | 1.300 | 33.02 | .715 | 18.16 | .465 | 11.81 |
| 15 Socket | 1.540 | 39.12 | 1.300 | 33.02 | .715 | 18.16 | .465 | 11.81 |
| 21 Plug | 1.690 | 42.93 | 1.450 | 36.83 | .865 | 21.97 | .465 | 11.81 |
| 21 Socket | 1.690 | 42.93 | 1.450 | 36.83 | .865 | 21.97 | .465 | 11.81 |
| 25 Plug | 1.790 | 45.47 | 1.550 | 39.37 | .965 | 24.51 | .465 | 11.81 |
| 25 Socket | 1.790 | 45.47 | 1.550 | 39.37 | .965 | 24.51 | .465 | 11.81 |
| 31 Plug | 2.040 | 51.82 | 1.800 | 45.72 | 1.115 | 28.32 | .465 | 11.81 |
| 31 Socket | 2.040 | 51.82 | 1.800 | 45.72 | 1.115 | 28.32 | .465 | 11.81 |
| 37 Plug | 2.340 | 59.44 | 2.100 | 53.34 | 1.265 | 32.13 | .465 | 11.81 |
| 37 Socket | 2.340 | 59.44 | 2.100 | 53.34 | 1.265 | 32.13 | .465 | 11.81 |
| 51 Plug | 1.875 | 47.63 | 1.600 | 40.64 | 1.215 | 30.86 | .565 | 14.35 |
| 51 Socket | 1.875 | 47.63 | 1.600 | 40.64 | 1.215 | 30.86 | .565 | 14.35 |
| 100 Plug | 2.780 | 70.61 | 2.500 | 63.50 | 1.800 | 45.72 | .765 | 19.43 |
| 100 Socket | 2.780 | 70.61 | 2.500 | 63.50 | 1.800 | 45.72 | .765 | 19.43 |

| No. of Contacts | G | | H | | J | | K | |
|-----------------|------|-------|------|------|------|------|------|------|
| | in | mm | in | mm | in | mm | in | mm |
| 9 Plug | .308 | 7.82 | .190 | 4.83 | .096 | 2.44 | .125 | 3.18 |
| 9 Socket | .308 | 7.82 | .200 | 5.08 | .096 | 2.44 | .125 | 3.18 |
| 15 Plug | .308 | 7.82 | .190 | 4.83 | .096 | 2.44 | .125 | 3.18 |
| 15 Socket | .308 | 7.82 | .200 | 5.08 | .096 | 2.44 | .125 | 3.18 |
| 21 Plug | .308 | 7.82 | .190 | 4.83 | .096 | 2.44 | .125 | 3.18 |
| 21 Socket | .308 | 7.82 | .200 | 5.08 | .096 | 2.44 | .125 | 3.18 |
| 25 Plug | .308 | 7.82 | .190 | 4.83 | .096 | 2.44 | .125 | 3.18 |
| 25 Socket | .308 | 7.82 | .200 | 5.08 | .096 | 2.44 | .125 | 3.18 |
| 31 Plug | .308 | 7.82 | .190 | 4.83 | .096 | 2.44 | .125 | 3.18 |
| 31 Socket | .308 | 7.82 | .200 | 5.08 | .096 | 2.44 | .125 | 3.18 |
| 37 Plug | .308 | 7.82 | .190 | 4.83 | .096 | 2.44 | .125 | 3.18 |
| 37 Socket | .308 | 7.82 | .200 | 5.08 | .096 | 2.44 | .125 | 3.18 |
| 51 Plug | .351 | 8.92 | .190 | 4.83 | .096 | 2.44 | .125 | 3.18 |
| 51 Socket | .351 | 8.92 | .200 | 5.08 | .096 | 2.44 | .125 | 3.18 |
| 100 Plug | .394 | 10.00 | .190 | 4.83 | .125 | 3.18 | .225 | 5.72 |
| 100 Socket | .394 | 10.00 | .200 | 5.08 | .125 | 3.18 | .225 | 5.72 |

Dura-Con High Reliability Metal Shell

.050" (1.27mm) Density
PCB Mount Terminal Block



Straight (180°) Termination



Recommended Board Layout

(As Viewed from Bottom of Terminal Block)



Typ. Hole Dia. = .040" (1.02 mm)

NOTE: For additional connector dimensions, see page 5-10.

| No. of Contacts | A Max. | | B ± .007 (0.18) | | C ± .005 (0.13) | | D Max. | | G Max. | |
|-----------------|-----------|-------|--------------------|-------|--------------------|-------|-----------|-------|-----------|-------|
| | in | mm | in | mm | in | mm | in | mm | in | mm |
| 9 Plug | 1.390 | 35.31 | 1.150 | 29.21 | .565 | 14.35 | .885 | 22.48 | .308 | 7.75 |
| 9 Socket | 1.390 | 35.31 | 1.150 | 29.21 | .565 | 14.35 | .885 | 22.48 | .308 | 7.75 |
| 15 Plug | 1.390 | 35.31 | 1.150 | 29.21 | .715 | 18.16 | .945 | 24.0 | .308 | 7.75 |
| 15 Socket | 1.390 | 35.31 | 1.150 | 29.21 | .715 | 18.16 | .945 | 24.0 | .308 | 7.75 |
| 21 Plug | 1.690 | 42.93 | 1.450 | 36.83 | .865 | 21.97 | 1.185 | 30.09 | .308 | 7.75 |
| 21 Socket | 1.690 | 42.93 | 1.450 | 36.83 | .865 | 21.97 | 1.185 | 30.09 | .308 | 7.75 |
| 25 Plug | 1.740 | 44.20 | 1.500 | 38.10 | .965 | 24.51 | 1.275 | 32.38 | .308 | 7.75 |
| 25 Socket | 1.740 | 44.20 | 1.500 | 38.10 | .965 | 24.51 | 1.275 | 32.38 | .308 | 7.75 |
| 31 Plug | 2.040 | 51.82 | 1.800 | 45.72 | 1.115 | 28.32 | 1.575 | 40.00 | .308 | 7.75 |
| 31 Socket | 2.040 | 51.82 | 1.800 | 45.72 | 1.115 | 28.32 | 1.575 | 40.00 | .308 | 7.75 |
| 37 Plug | 2.340 | 59.44 | 2.100 | 53.34 | 1.265 | 32.13 | 1.875 | 47.62 | .308 | 7.75 |
| 37 Socket | 2.340 | 59.44 | 2.100 | 53.34 | 1.265 | 32.13 | 1.875 | 47.62 | .308 | 7.75 |
| 51 Plug | 2.270 | 57.66 | 2.000 | 50.80 | 1.215 | 30.86 | 1.775 | 45.08 | .351 | 8.92 |
| 51 Socket | 2.270 | 57.66 | 2.000 | 50.80 | 1.215 | 30.86 | 1.775 | 45.08 | .351 | 8.92 |
| 100 Plug | 3.070 | 77.98 | 2.800 | 71.12 | 1.800 | 45.72 | 2.585 | 65.55 | .455 | 11.56 |
| 100 Socket | 3.070 | 77.98 | 2.800 | 71.12 | 1.800 | 45.72 | 2.585 | 65.65 | .455 | 11.56 |

| No. of Contacts | H Max. | | J ± .005 (0.13) | | K Max. | | L Max. | |
|-----------------|-----------|------|--------------------|------|-----------|------|-----------|-------|
| | in | mm | in | mm | in | mm | in | mm |
| 9 Plug | .190 | 4.83 | .096 | 2.44 | .165 | 4.19 | .355 | 9.02 |
| 9 Socket | .200 | 5.08 | .096 | 2.44 | .165 | 4.19 | .355 | 9.02 |
| 15 Plug | .190 | 4.83 | .096 | 2.44 | .165 | 4.19 | .355 | 9.02 |
| 15 Socket | .200 | 5.08 | .096 | 2.44 | .165 | 4.19 | .355 | 9.02 |
| 21 Plug | .190 | 4.83 | .096 | 2.44 | .165 | 4.19 | .355 | 9.02 |
| 21 Socket | .200 | 5.08 | .096 | 2.44 | .165 | 4.19 | .355 | 9.02 |
| 25 Plug | .190 | 4.83 | .096 | 2.44 | .165 | 4.19 | .355 | 9.02 |
| 25 Socket | .200 | 5.08 | .096 | 2.44 | .165 | 4.19 | .355 | 9.02 |
| 31 Plug | .190 | 4.83 | .096 | 2.44 | .165 | 4.19 | .355 | 9.02 |
| 31 Socket | .200 | 5.08 | .096 | 2.44 | .165 | 4.19 | .355 | 9.02 |
| 37 Plug | .190 | 4.83 | .096 | 2.44 | .165 | 4.19 | .355 | 9.02 |
| 37 Socket | .200 | 5.08 | .096 | 2.44 | .165 | 4.19 | .355 | 9.02 |
| 51 Plug | .190 | 4.83 | .096 | 2.44 | .165 | 4.19 | .355 | 9.02 |
| 51 Socket | .200 | 5.08 | .096 | 2.44 | .165 | 4.19 | .355 | 9.02 |
| 100 Plug | .190 | 4.83 | .125 | 3.18 | .300 | 7.62 | .550 | 13.97 |
| 100 Socket | .200 | 5.08 | .125 | 3.18 | .300 | 7.62 | .550 | 13.97 |

90° Narrow Termination



Recommended Board Layout

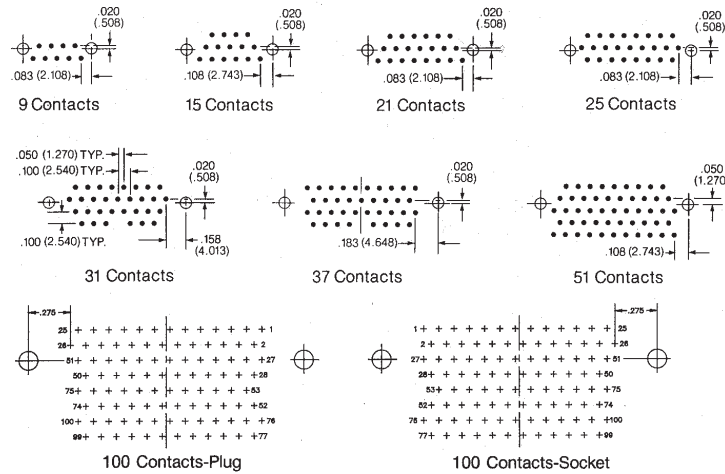

(As Viewed from Bottom of Terminal Block)

NOTE: For additional connector dimensions, see page 5-10.

Typ. Hole Dia. = .040" (1.02 mm)

| No. of Contacts | A | | B | | C | |
|-----------------|-------|-------|-------|-------|------|-------|
| | in | mm | in | mm | in | mm |
| 9 Plug | .785 | 19.94 | .565 | 14.35 | .308 | 7.82 |
| 9 Socket | .785 | 19.94 | .565 | 14.35 | .308 | 7.82 |
| 15 Plug | .935 | 23.75 | .715 | 18.16 | .308 | 7.82 |
| 15 Socket | .935 | 23.75 | .715 | 18.16 | .308 | 7.82 |
| 21 Plug | 1.085 | 27.56 | .865 | 21.97 | .308 | 7.82 |
| 21 Socket | 1.085 | 27.56 | .865 | 21.97 | .308 | 7.82 |
| 25 Plug | 1.085 | 30.10 | .965 | 24.51 | .308 | 7.82 |
| 25 Socket | 1.185 | 30.10 | .965 | 24.51 | .308 | 7.82 |
| 31 Plug | 1.335 | 33.91 | 1.115 | 28.32 | .308 | 7.82 |
| 31 Socket | 1.335 | 33.91 | 1.115 | 28.32 | .308 | 7.82 |
| 37 Plug | 1.485 | 37.72 | 1.265 | 32.13 | .308 | 7.82 |
| 37 Socket | 1.485 | 37.72 | 1.265 | 32.13 | .308 | 7.82 |
| 51 Plug | 1.435 | 36.45 | 1.215 | 30.86 | .351 | 8.92 |
| 51 Socket | 1.435 | 36.45 | 1.215 | 30.86 | .351 | 8.92 |
| 100 Plug | 2.175 | 55.25 | 1.800 | 45.72 | .394 | 10.00 |
| 100 Socket | 2.175 | 55.25 | 1.800 | 45.72 | .394 | 10.00 |

| No. of Contacts | F | | G | | H | | J | |
|-----------------|------|------|------|-------|-------|-------|------|------|
| | in | mm | in | mm | in | mm | in | mm |
| 9 Plug | .230 | 5.84 | .250 | 6.35 | .420 | 10.67 | .096 | 2.44 |
| 9 Socket | .230 | 5.84 | .250 | 6.35 | .420 | 10.67 | .096 | 2.44 |
| 15 Plug | .130 | 3.30 | .250 | 6.35 | .420 | 10.67 | .096 | 2.44 |
| 15 Socket | .130 | 3.30 | .250 | 6.35 | .420 | 10.67 | .096 | 2.44 |
| 21 Plug | .130 | 3.30 | .250 | 6.35 | .420 | 10.67 | .096 | 2.44 |
| 21 Socket | .130 | 3.30 | .250 | 6.35 | .420 | 10.67 | .096 | 2.44 |
| 25 Plug | .130 | 3.30 | .250 | 6.35 | .420 | 10.67 | .096 | 2.44 |
| 25 Socket | .130 | 3.30 | .250 | 6.35 | .420 | 10.67 | .096 | 2.44 |
| 31 Plug | .130 | 3.30 | .250 | 6.35 | .520 | 13.21 | .096 | 2.44 |
| 31 Socket | .130 | 3.30 | .250 | 6.35 | .520 | 13.21 | .096 | 2.44 |
| 37 Plug | .130 | 3.30 | .250 | 6.35 | .520 | 13.21 | .096 | 2.44 |
| 37 Socket | .130 | 3.30 | .250 | 6.35 | .520 | 13.21 | .096 | 2.44 |
| 51 Plug | .150 | 3.81 | .300 | 7.62 | .650 | 16.51 | .096 | 2.44 |
| 51 Socket | .150 | 3.81 | .300 | 7.62 | .650 | 16.51 | .096 | 2.44 |
| 100 Plug | .200 | 5.08 | .400 | 10.16 | 1.000 | 25.40 | .125 | 3.18 |
| 100 Socket | .200 | 5.08 | .400 | 10.16 | 1.000 | 25.40 | .125 | 3.18 |

Dura-Con
High Reliability
MIL-C-83513

.050" (1.27mm) Density
 Solder Cup/Wire
 D-Microminiature



FEATURES

- All-plastic and metal shell wire versions available in solder cup, gold-plated solid wire, and insulated stranded wire.
- PCB mount "terminal block" type connectors available in straight or right angle.
- Sizes offered - 9, 15, 21, 25, 31, 35, 51, and 100 (metal shell only).
- All products are qualified to the requirements of MIL-C-83513 and marked with the M83513 part number.
- Optional shell platings and insulator materials offer high performance in harsh environments.
- Mounting hardware per MIL-C-83513.



MATERIALS

Insulator: UL94V-0 rated glass-filled polyester per MIL-M-24519 or diallyl phthalate (DAP) per MIL-M-14.
Contacts: Pins - Copper alloy, Sockets - Copper alloy
Contact Plating: .000050 in gold per MIL-G-45204
Shell Material (Metal Shell Only): Aluminum alloy
Shell Plating (Metal Shell Only): Yellow chromate over cadmium (std.) or electroless nickel

ENVIRONMENTAL

Operating Temperature: -55°C to +125°C

ELECTRICAL

Current Rating: 3 Amps maximum
Withstanding Voltage: 600 VAC RMS @ sea level
Contact Resistance: 8 milliohms maximum

MECHANICAL

Durability: 500 mate/unmate cycles
Individual Contact: Forces 6 oz. (170.40 g) maximum insertion;
 0.5 oz. (14.20 g) minimum withdrawal
Mating / Unmating Force: See table

| No. of Contacts | Maximum Mating Force | | Minimum Unmating Force | |
|-----------------|----------------------|-------|------------------------|-----|
| | Lb. | Kg | Lb. | Kg |
| 9 | 5.63 | 2.56 | .28 | .13 |
| 15 | 9.38 | 4.26 | .47 | .21 |
| 21 | 13.13 | 5.96 | .66 | .30 |
| 25 | 15.63 | 7.10 | .78 | .35 |
| 31 | 19.38 | 8.80 | .97 | .44 |
| 37 | 23.13 | 10.50 | 1.16 | .53 |
| 51 | 31.88 | 14.47 | 1.59 | .72 |

Metal Shell

Contact Arrangements

(Face view of pin insert)

(Use reverse order for socket side)



Ordering Information

M83513/04 - A 03 C

Connector Type

- 01 - Metal Shell D Plugs with Solder Cup Termination
- 02 - Metal Shell D Sockets with Solder Cup Termination
- 03 - Metal Shell D Plugs with Wire Leads
- 04 - Metal Shell D Sockets with Wire Leads

Insert Arrangements

(No. of Contacts)

- A = 9
- B = 15
- C = 21
- D = 25
- E = 31
- F = 37
- G = 51
- H = 100

Shell Finish

- C = Cadmium
- N = Electroless Nickel

Wire Type (Use only for /03 & /04, otherwise omit)

- 01 - M22759/11-26-9, 18 inches, White (see note below)
- 02 - M22759/11-26-9, 36 inches, White (see note below)
- 03 - M22759/11-26-(-), 18 inches, Color Coded (see note below)
- 04 - M22759/11-26-(-), 36 inches, Color Coded (see note below)
- 05 - QQ-W-343, 25 AWG, 0.5 inch, Gold-Plated
- 06 - QQ-W-343, 25 AWG, 1.0 inch, Gold-Plated
- 07 - QQ-W-343, 25 AWG, 0.5 inch, Tin-Plated
- 08 - QQ-W-343, 25 AWG, 1.0 inch, Tin-Plated
- 09 - M22759/33-26-9, 18 inches, White
- 10 - M22759/33-26-9, 36 inches, White
- 11 - M22759/33-26-(-), 18 inches, Color Coded
- 12 - M22759/33-26-(-), 36 inches, Color Coded
- 13 - M22759/11-26-9, 72 inches, White
- 14 - M22759/11-26-(-), 72 inches, Color Coded
- 15 - M22759/33-26-9, 72 inches, White
- 16 - M22759/33-26-(-), 72 inches, Color Coded

Note: See page 5-31 for M83513 mounting hardware.

Connector Dimensions - Metal Shell



| No. of Contacts | A | | B Max. (Plug) Min. (Socket) | | C + .010" (.254) - .018" (.457) | | D | | E | | F Max. | |
|-----------------|----------------|-------|--------------------------------|-------|---------------------------------------|-------|----------------|-------|----------------|------|--------|------|
| | ± .010" (.254) | | | | | | ± .005" (.127) | | ± .010" (.254) | | | |
| | in | mm | in | mm | in | mm | in | mm | in | mm | in | mm |
| 9 Plug | .775 | 19.68 | .3338 | 8.48 | .390 | 9.91 | .565 | 14.35 | .298 | 7.57 | .270 | 6.68 |
| 9 Socket | .775 | 19.68 | .3342 | 8.49 | .390 | 9.91 | .565 | 14.35 | .298 | 7.57 | .270 | 6.68 |
| 15 Plug | .925 | 23.50 | .4838 | 12.29 | .540 | 13.72 | .715 | 18.16 | .298 | 7.57 | .270 | 6.68 |
| 15 Socket | .925 | 23.50 | .4842 | 12.30 | .540 | 13.72 | .715 | 18.16 | .298 | 7.57 | .270 | 6.68 |
| 21 Plug | 1.075 | 27.30 | .6338 | 16.10 | .690 | 17.53 | .865 | 21.97 | .298 | 7.57 | .270 | 6.68 |
| 21 Socket | 1.075 | 27.30 | .6342 | 16.11 | .690 | 17.53 | .865 | 21.97 | .298 | 7.57 | .270 | 6.68 |
| 25 Plug | 1.175 | 29.84 | .7338 | 18.64 | .790 | 20.07 | .965 | 24.51 | .298 | 7.57 | .270 | 6.68 |
| 25 Socket | 1.175 | 29.84 | .7342 | 18.65 | .790 | 20.07 | .965 | 24.51 | .298 | 7.57 | .270 | 6.68 |
| 31 Plug | 1.325 | 33.66 | .8838 | 22.45 | .940 | 23.88 | 1.115 | 28.32 | .298 | 7.57 | .270 | 6.68 |
| 31 Socket | 1.325 | 33.66 | .8842 | 22.46 | .940 | 23.88 | 1.115 | 28.32 | .298 | 7.57 | .270 | 6.68 |
| 37 Plug | 1.475 | 37.46 | 1.0338 | 26.26 | 1.090 | 27.69 | 1.265 | 32.13 | .298 | 7.57 | .270 | 6.68 |
| 37 Socket | 1.475 | 37.46 | 1.0342 | 26.27 | 1.090 | 27.69 | 1.265 | 32.13 | .298 | 7.57 | .270 | 6.68 |
| 51 Plug | 1.425 | 36.20 | .9838 | 24.99 | 1.040 | 26.42 | 1.215 | 30.86 | .341 | 8.66 | .310 | 7.87 |
| 51 Socket | 1.425 | 36.20 | .9842 | 25.00 | 1.040 | 26.42 | 1.215 | 30.86 | .341 | 8.66 | .310 | 7.87 |
| 100 Plug | 2.160 | 54.86 | 1.3838 | 35.15 | 1.432 | 36.38 | 1.800 | 45.71 | .384 | 9.75 | .360 | 9.15 |
| 100 Socket | 2.160 | 54.86 | 1.3842 | 35.16 | 1.432 | 36.38 | 1.800 | 45.71 | .384 | 9.75 | .360 | 9.15 |

Panel Mounting Dimensions - Metal Shell

Panel Mounting Dimensions

Pin and socket, rear mounted



Pin and socket, front mounted



Pin, front mounted
 Socket, rear mounted

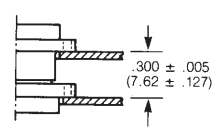

Front Mounting

Panel Cutout Dimensions - Metal Shell

| No. of Contacts | A | | B | | C | | D | |
|-----------------|-----------------|-------|-----------------|------|-----------------|-------|-----------------|------|
| | +.004" (.101mm) | | +.004" (.101mm) | | +.005" (.127mm) | | +.005" (.127mm) | |
| | -.000" (.000mm) | | -.000" (.000mm) | | -.000" (.000mm) | | -.000" (.000mm) | |
| | in | mm | in | mm | in | mm | in | mm |
| 9 | .408 | 10.36 | .270 | 6.86 | .570 | 14.48 | .089 | 2.26 |
| 15 | .558 | 14.17 | .270 | 6.86 | .720 | 18.29 | .089 | 2.26 |
| 21 | .708 | 17.98 | .270 | 6.86 | .870 | 22.10 | .089 | 2.26 |
| 25 | .808 | 20.52 | .270 | 6.86 | .970 | 24.64 | .089 | 2.26 |
| 31 | .958 | 24.33 | .270 | 6.86 | 1.120 | 28.45 | .089 | 2.26 |
| 37 | 1.108 | 28.14 | .270 | 6.86 | 1.270 | 32.26 | .089 | 2.26 |
| 51 | 1.058 | 26.87 | .315 | 8.00 | 1.220 | 30.99 | .089 | 2.26 |
| 100 | 1.450 | 36.84 | .361 | 9.17 | 1.805 | 45.86 | .117 | 2.97 |



Rear Mounting

| No. of Contacts | A | | B | | C | | D | |
|-----------------|-----------------|-------|-----------------|------|-----------------|-------|-----------------|------|
| | +.004" (.101mm) | | +.004" (.101mm) | | +.005" (.127mm) | | +.005" (.127mm) | |
| | -.000" (.000mm) | | -.000" (.000mm) | | -.000" (.000mm) | | -.000" (.000mm) | |
| | in | mm | in | mm | in | mm | in | mm |
| 9 | .408 | 10.36 | .256 | 6.50 | .570 | 14.48 | .089 | 2.26 |
| 15 | .558 | 14.17 | .256 | 6.50 | .720 | 18.29 | .089 | 2.26 |
| 21 | .708 | 17.98 | .256 | 6.50 | .870 | 22.10 | .089 | 2.26 |
| 25 | .808 | 20.52 | .256 | 6.50 | .970 | 24.64 | .089 | 2.26 |
| 31 | .958 | 24.33 | .256 | 6.50 | 1.120 | 28.45 | .089 | 2.26 |
| 37 | 1.108 | 28.14 | .256 | 6.50 | 1.270 | 32.26 | .089 | 2.26 |
| 51 | 1.058 | 26.87 | .300 | 7.62 | 1.220 | 30.99 | .089 | 2.26 |
| 100 | 1.450 | 36.84 | .338 | 8.58 | 1.805 | 45.86 | .117 | 2.97 |



Edgeboard Mounting

| No. of Contacts | C | | D | |
|-----------------|-----------------|-------|-----------------|------|
| | +.005" (.127mm) | | +.005" (.127mm) | |
| | -.000" (.000mm) | | -.000" (.000mm) | |
| | in | mm | in | mm |
| 9 | .570 | 14.48 | .089 | 2.26 |
| 15 | .720 | 18.29 | .089 | 2.26 |
| 21 | .870 | 22.10 | .089 | 2.26 |
| 25 | .970 | 24.64 | .089 | 2.26 |
| 31 | 1.120 | 28.45 | .089 | 2.26 |
| 37 | 1.270 | 32.26 | .089 | 2.26 |
| 51 | 1.220 | 30.99 | .089 | 2.26 |
| 100 | 1.805 | 45.86 | .117 | 2.97 |

Plastic Shell

Contact Arrangements
 (Face view of pin insert)
 (Use reverse order for socket side)



Ordering Information

M83513/06-A 04

Connector Type

- 06** - Plastic Shell Plugs with Solder Cup Termination
- 07** - Plastic Shell Sockets with Solder Cup Termination
- 08** - Plastic Shell Plugs with Wire Leads
- 09** - Plastic Shell Sockets with Wire Leads

Insert Arrangements

(No. of Contacts)

- A** = 9
- B** = 15
- C** = 21
- D** = 25
- E** = 31
- F** = 37
- G** = 51

Wire Type (Use only for /08 & /09, otherwise omit)

- 01** - M22759/11-26-9, 18 inches, White
- 02** - M22759/11-26-9, 36 inches, White
- 03** - M22759/11-26-(), 18 inches, Color Coded
- 04** - M22759/11-26-(), 36 inches, Color Coded
- 05** - QQ-W-343, 25 AWG, 0.5 inch, Gold-Plated
- 06** - QQ-W-343, 25 AWG, 1.0 inch, Gold-Plated
- 07** - QQ-W-343, 25 AWG, 0.5 inch, Tin-Plated
- 08** - QQ-W-343, 25 AWG, 1.0 inch, Tin-Plated
- 09** - M22759/33-26-9, 18 inches, White
- 10** - M22759/33-26-9, 36 inches, White
- 11** - M22759/33-26-(), 18 inches, Color Coded
- 12** - M22759/33-26-(), 36 inches, Color Coded
- 13** - M22759/11-26-9, 72 inches, White
- 14** - M22759/11-26-(), 72 inches, Color Coded
- 15** - M22759/33-26-9, 72 inches, White
- 16** - M22759/33-26-(), 72 inches, Color Coded

Note: See page 5-31 for M83513 mounting hardware.

5

Shell Dimensions - (All-Plastic Version)

Plug



Socket



| No. of Contacts | A | | B Max. (Plug) Min. (Socket) | | C +.010" (.254) -.018" (.457) | | D | | E | | F Max. | |
|-----------------|---------------|-------|--------------------------------|-------|-------------------------------------|-------|---------------|-------|---------------|------|--------|------|
| | ±.010" (.254) | | | | | | ±.005" (.127) | | ±.010" (.254) | | | |
| | in | mm | in | mm | in | mm | in | mm | in | mm | in | mm |
| 9 Plug | .778 | 19.76 | .2918 | 7.41 | .398 | 10.11 | .565 | 14.35 | .208 | 5.28 | .173 | 4.39 |
| 9 Socket | .778 | 19.76 | .2922 | 7.42 | .398 | 10.11 | .565 | 14.35 | .208 | 5.28 | .173 | 4.39 |
| 15 Plug | .928 | 23.57 | .4418 | 11.22 | .548 | 13.92 | .715 | 18.16 | .208 | 5.28 | .173 | 4.39 |
| 15 Socket | .928 | 23.57 | .4422 | 11.23 | .548 | 13.92 | .715 | 18.16 | .208 | 5.28 | .173 | 4.39 |
| 21 Plug | 1.078 | 27.38 | .5918 | 15.03 | .698 | 17.73 | .865 | 21.97 | .208 | 5.28 | .173 | 4.39 |
| 21 Socket | 1.078 | 27.38 | .5922 | 15.04 | .698 | 17.73 | .865 | 21.97 | .208 | 5.28 | .173 | 4.39 |
| 25 Plug | 1.178 | 29.92 | .6918 | 17.57 | .798 | 20.27 | .965 | 24.51 | .208 | 5.28 | .173 | 4.39 |
| 25 Socket | 1.178 | 29.92 | .6922 | 17.58 | .798 | 20.27 | .965 | 24.51 | .208 | 5.28 | .173 | 4.39 |
| 31 Plug | 1.328 | 33.73 | .8418 | 21.38 | .948 | 24.08 | 1.115 | 28.32 | .208 | 5.28 | .173 | 4.39 |
| 31 Socket | 1.328 | 33.73 | .8422 | 21.39 | .948 | 24.08 | 1.115 | 28.32 | .208 | 5.28 | .173 | 4.39 |
| 37 Plug | 1.478 | 37.54 | .9918 | 25.19 | 1.098 | 27.89 | 1.265 | 32.13 | .208 | 5.28 | .173 | 4.39 |
| 37 Socket | 1.478 | 37.54 | .9922 | 25.20 | 1.098 | 27.89 | 1.265 | 32.13 | .208 | 5.28 | .173 | 4.39 |
| 51 Plug | 1.428 | 36.27 | .9418 | 23.92 | 1.048 | 26.62 | 1.215 | 30.86 | .250 | 6.35 | .220 | 5.59 |
| 51 Socket | 1.428 | 36.27 | .9422 | 23.93 | 1.048 | 26.62 | 1.215 | 30.86 | .250 | 6.35 | .220 | 5.59 |

Panel Mounting Dimensions - All-Plastic



Plug and socket, rear mounted

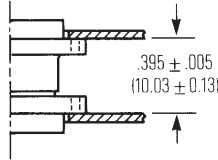

Plug and socket, front mounted

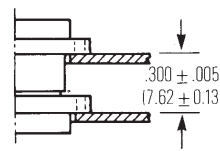

Plug, front mounted; Socket, rear mounted

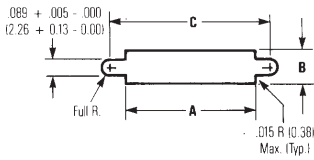

Front Mounting

Panel Cutout Dimensions

| No. of Contacts | A + .004" (.101mm) - .000" (.000mm) | | B + .004" (.101mm) - .000" (.000mm) | | C + .005" (.127mm) - .000" (.000mm) | |
|-----------------|---|-------|---|------|---|-------|
| | in | mm | in | mm | in | mm |
| 9 | .408 | 10.36 | .172 | 4.37 | .570 | 14.48 |
| 15 | .558 | 14.17 | .172 | 4.37 | .720 | 18.29 |
| 21 | .708 | 17.98 | .172 | 4.37 | .870 | 22.10 |
| 25 | .808 | 20.52 | .172 | 4.37 | .970 | 24.64 |
| 31 | .958 | 24.33 | .172 | 4.37 | 1.120 | 28.45 |
| 37 | 1.108 | 28.14 | .172 | 4.37 | 1.270 | 32.26 |
| 51 | 1.058 | 26.87 | .215 | 5.46 | 1.220 | 30.99 |

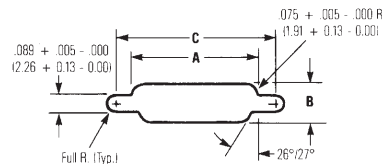

Rear Mounting

Rear Cutout Dimensions

| No. of Contacts | A + .004" (.101mm) - .000" (.000mm) | | B + .004" (.101mm) - .000" (.000mm) | | C + .005" (.127mm) - .000" (.000mm) | |
|-----------------|---|-------|---|------|---|-------|
| | in | mm | in | mm | in | mm |
| 9 | .373 | 9.47 | .216 | 5.49 | .570 | 14.48 |
| 15 | .523 | 13.28 | .216 | 5.49 | .720 | 18.29 |
| 21 | .674 | 17.12 | .216 | 5.49 | .870 | 22.10 |
| 25 | .774 | 19.66 | .216 | 5.49 | .970 | 24.64 |
| 31 | .924 | 23.47 | .216 | 5.49 | 1.120 | 28.45 |
| 37 | 1.074 | 27.28 | .216 | 5.49 | 1.270 | 32.26 |
| 51 | 1.024 | 26.01 | .259 | 6.58 | 1.220 | 30.99 |

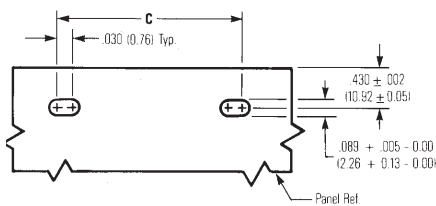

Edgeboard Mounting

Edgeboard Mounting Cutout Dimensions

| No. of Contacts | D + .005" (.127mm) - .000" (.000mm) | |
|-----------------|---|-------|
| | in | mm |
| 9 | .570 | 14.48 |
| 15 | .720 | 18.29 |
| 21 | .870 | 22.10 |
| 25 | .970 | 24.64 |
| 31 | 1.120 | 28.45 |
| 37 | 1.270 | 32.26 |
| 51 | 1.220 | 30.99 |

Terminal Block

Contact Arrangements

(Face view of pin insert)
(Use reverse order for socket side)



Ordering Information

M83513/10 - C 02 C N

Connector Description

- 10 = Plug, 9-37 Pos., Narrow Profile, Rt. Angle
- 11 = Plug, 51 Pos., Narrow Profile, Rt. Angle
- 12 = Plug, 100 Pos., Narrow Profile, Rt. Angle
- 13 = Socket, 9-37 Pos., Narrow Profile, Rt. Angle
- 14 = Socket, 51 Pos., Narrow Profile, Rt. Angle
- 15 = Socket, 100 Pos., Narrow Profile, Rt. Angle
- 16 = Plug, 9-37 Pos., Std. Profile, Rt. Angle
- 17 = Plug, 51 Pos., Std. Profile, Rt. Angle
- 18 = Plug, 100 Pos., Std. Profile, Rt. Angle
- 19 = Socket, 9-37 Pos., Std. Profile, Rt. Angle
- 20 = Socket, 51 Pos., Std. Profile, Rt. Angle
- 21 = Socket, 100 Pos., Std. Profile, Rt. Angle
- 22 = Plug, 9-37 Pos., Straight Mount
- 23 = Plug, 51 Pos., Straight Mount
- 24 = Plug, 100 Pos., Straight Mount
- 25 = Socket, 9-37 Pos., Straight Mount
- 26 = Socket, 51 Pos., Straight Mount
- 27 = Socket, 100 Pos., Straight Mount

Hardware

- N = No Jackpost
- P = Jackpost Attached

Shell Finish

- C = Cadmium
- N = Electroless Nickel

Termination Length

- 01 = 0.109
- 02 = 0.140
- 03 = 0.172

Insert Arrangement Length
(No. of Contacts)

- A = 9
- B = 15
- C = 21
- D = 25
- E = 31
- F = 37
- G = 51
- H = 100



90° Termination
(/16-/21)

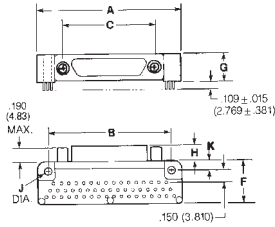

Recommended Board Layout

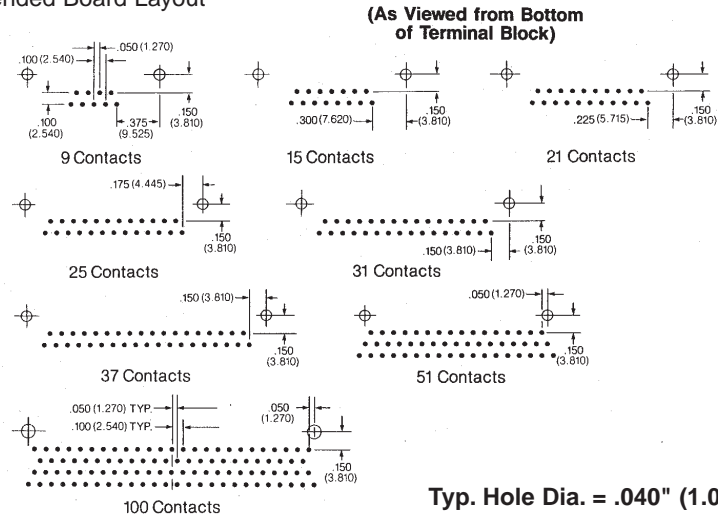

NOTE: For additional connector dimensions, see page 5-22.

| No. of Contacts | A Max. | | B ± .007 (0.18) | | C ± .005 (0.13) | | F Max. | |
|-----------------|-----------|-------|--------------------|-------|--------------------|-------|-----------|-------|
| | in | mm | in | mm | in | mm | in | mm |
| 9 Plug | 1.390 | 35.31 | 1.150 | 29.21 | .565 | 14.35 | .465 | 11.81 |
| 9 Socket | 1.390 | 35.31 | 1.150 | 29.21 | .565 | 14.35 | .465 | 11.81 |
| 15 Plug | 1.540 | 39.12 | 1.300 | 33.02 | .715 | 18.16 | .465 | 11.81 |
| 15 Socket | 1.540 | 39.12 | 1.300 | 33.02 | .715 | 18.16 | .465 | 11.81 |
| 21 Plug | 1.690 | 42.93 | 1.450 | 36.83 | .865 | 21.97 | .465 | 11.81 |
| 21 Socket | 1.690 | 42.93 | 1.450 | 36.83 | .865 | 21.97 | .465 | 11.81 |
| 25 Plug | 1.790 | 45.47 | 1.550 | 39.37 | .965 | 24.51 | .465 | 11.81 |
| 25 Socket | 1.790 | 45.47 | 1.550 | 39.37 | .965 | 24.51 | .465 | 11.81 |
| 31 Plug | 2.040 | 51.82 | 1.800 | 45.72 | 1.115 | 28.32 | .465 | 11.81 |
| 31 Socket | 2.040 | 51.82 | 1.800 | 45.72 | 1.115 | 28.32 | .465 | 11.81 |
| 37 Plug | 2.340 | 59.44 | 2.100 | 53.34 | 1.265 | 32.13 | .465 | 11.81 |
| 37 Socket | 2.340 | 59.44 | 2.100 | 53.34 | 1.265 | 32.13 | .465 | 11.81 |
| 51 Plug | 1.875 | 47.63 | 1.600 | 40.64 | 1.215 | 30.86 | .565 | 14.35 |
| 51 Socket | 1.875 | 47.63 | 1.600 | 40.64 | 1.215 | 30.86 | .565 | 14.35 |
| 100 Plug | 2.780 | 70.61 | 2.500 | 63.50 | 1.800 | 45.72 | .765 | 19.43 |
| 100 Socket | 2.780 | 70.61 | 2.500 | 63.50 | 1.800 | 45.72 | .765 | 19.43 |

| No. of Contacts | G Max. | | H Max. | | J ± .005 (0.13) | | K ± .015 | |
|-----------------|-----------|-------|-----------|------|--------------------|------|-------------|------|
| | in | mm | in | mm | in | mm | in | mm |
| 9 Plug | .308 | 7.82 | .190 | 4.83 | .096 | 2.44 | .125 | 3.18 |
| 9 Socket | .308 | 7.82 | .200 | 5.08 | .096 | 2.44 | .125 | 3.18 |
| 15 Plug | .308 | 7.82 | .190 | 4.83 | .096 | 2.44 | .125 | 3.18 |
| 15 Socket | .308 | 7.82 | .200 | 5.08 | .096 | 2.44 | .125 | 3.18 |
| 21 Plug | .308 | 7.82 | .190 | 4.83 | .096 | 2.44 | .125 | 3.18 |
| 21 Socket | .308 | 7.82 | .200 | 5.08 | .096 | 2.44 | .125 | 3.18 |
| 25 Plug | .308 | 7.82 | .190 | 4.83 | .096 | 2.44 | .125 | 3.18 |
| 25 Socket | .308 | 7.82 | .200 | 5.08 | .096 | 2.44 | .125 | 3.18 |
| 31 Plug | .308 | 7.82 | .190 | 4.83 | .096 | 2.44 | .125 | 3.18 |
| 31 Socket | .308 | 7.82 | .200 | 5.08 | .096 | 2.44 | .125 | 3.18 |
| 37 Plug | .308 | 7.82 | .190 | 4.83 | .096 | 2.44 | .125 | 3.18 |
| 37 Socket | .308 | 7.82 | .200 | 5.08 | .096 | 2.44 | .125 | 3.18 |
| 51 Plug | .351 | 8.92 | .190 | 4.83 | .096 | 2.44 | .125 | 3.18 |
| 51 Socket | .351 | 8.92 | .200 | 5.08 | .096 | 2.44 | .125 | 3.18 |
| 100 Plug | .394 | 10.00 | .190 | 4.83 | .125 | 3.18 | .225 | 5.72 |
| 100 Socket | .394 | 10.00 | .200 | 5.08 | .125 | 3.18 | .225 | 5.72 |

Straight (180°) Termination
(I22-I27)



Recommended Board Layout



Typ. Hole Dia. = .040" (1.02 mm)

NOTE: For additional connector dimensions, see page 5-22.

| No. of Contacts | A Max. | | B ± .007 (0.18) | | C ± .005 (0.13) | | D Max. | | G Max. | |
|--------------------|-----------|-------|--------------------|-------|--------------------|-------|-----------|-------|-----------|-------|
| | in | mm | in | mm | in | mm | in | mm | in | mm |
| 9 Plug | 1.390 | 35.31 | 1.150 | 29.21 | .565 | 14.35 | .885 | 22.48 | .308 | 7.75 |
| 9 Socket | 1.390 | 35.31 | 1.150 | 29.21 | .565 | 14.35 | .885 | 22.48 | .308 | 7.75 |
| 15 Plug | 1.390 | 35.31 | 1.150 | 29.21 | .715 | 18.16 | .945 | 24.0 | .308 | 7.75 |
| 15 Socket | 1.390 | 35.31 | 1.150 | 29.21 | .715 | 18.16 | .945 | 24.0 | .308 | 7.75 |
| 21 Plug | 1.690 | 42.93 | 1.450 | 36.83 | .865 | 21.97 | 1.185 | 30.09 | .308 | 7.75 |
| 21 Socket | 1.690 | 42.93 | 1.450 | 36.83 | .865 | 21.97 | 1.185 | 30.09 | .308 | 7.75 |
| 25 Plug | 1.740 | 44.20 | 1.500 | 38.10 | .965 | 24.51 | 1.275 | 32.38 | .308 | 7.75 |
| 25 Socket | 1.740 | 44.20 | 1.500 | 38.10 | .965 | 24.51 | 1.275 | 32.38 | .308 | 7.75 |
| 31 Plug | 2.040 | 51.82 | 1.800 | 45.72 | 1.115 | 28.32 | 1.575 | 40.00 | .308 | 7.75 |
| 31 Socket | 2.040 | 51.82 | 1.800 | 45.72 | 1.115 | 28.32 | 1.576 | 40.00 | .308 | 7.75 |
| 37 Plug | 2.340 | 59.44 | 2.100 | 53.34 | 1.265 | 32.13 | 1.875 | 47.62 | .308 | 7.75 |
| 37 Socket | 2.340 | 59.44 | 2.100 | 53.34 | 1.265 | 32.13 | 1.875 | 47.62 | .308 | 7.75 |
| 51 Plug | 2.270 | 57.66 | 2.000 | 50.80 | 1.215 | 30.86 | 1.775 | 45.08 | .351 | 8.92 |
| 51 Socket | 2.270 | 57.66 | 2.000 | 50.80 | 1.215 | 30.86 | 1.775 | 45.08 | .351 | 8.92 |
| 100 Plug | 3.070 | 77.98 | 2.800 | 71.12 | 1.800 | 45.72 | 2.585 | 65.55 | .455 | 11.56 |
| 100 Socket | 3.070 | 77.98 | 2.800 | 71.12 | 1.800 | 45.72 | 2.585 | 65.65 | .455 | 11.56 |

| No. of Contacts | H Max. | | J ± .005 (0.13) | | K Max. | | L Max. | |
|--------------------|-----------|------|--------------------|------|-----------|------|-----------|-------|
| | in | mm | in | mm | in | mm | in | mm |
| 9 Plug | .190 | 4.83 | .096 | 2.44 | .165 | 4.19 | .355 | 9.02 |
| 9 Socket | .200 | 5.08 | .096 | 2.44 | .165 | 4.19 | .355 | 9.02 |
| 15 Plug | .190 | 4.83 | .096 | 2.44 | .165 | 4.19 | .355 | 9.02 |
| 15 Socket | .200 | 5.08 | .096 | 2.44 | .165 | 4.19 | .355 | 9.02 |
| 21 Plug | .190 | 4.83 | .096 | 2.44 | .165 | 4.19 | .355 | 9.02 |
| 21 Socket | .200 | 5.08 | .096 | 2.44 | .165 | 4.19 | .355 | 9.02 |
| 25 Plug | .190 | 4.83 | .096 | 2.44 | .165 | 4.19 | .355 | 9.02 |
| 25 Socket | .200 | 5.08 | .096 | 2.44 | .165 | 4.19 | .355 | 9.02 |
| 31 Plug | .190 | 4.83 | .096 | 2.44 | .165 | 4.19 | .355 | 9.02 |
| 31 Socket | .200 | 5.08 | .096 | 2.44 | .165 | 4.19 | .355 | 9.02 |
| 37 Plug | .190 | 4.83 | .096 | 2.44 | .165 | 4.19 | .355 | 9.02 |
| 37 Socket | .200 | 5.08 | .096 | 2.44 | .165 | 4.19 | .355 | 9.02 |
| 51 Plug | .190 | 4.83 | .096 | 2.44 | .165 | 4.19 | .355 | 9.02 |
| 51 Socket | .200 | 5.08 | .096 | 2.44 | .165 | 4.19 | .355 | 9.02 |
| 100 Plug | .190 | 4.83 | .125 | 3.18 | .300 | 7.62 | .550 | 13.97 |
| 100 Socket | .200 | 5.08 | .125 | 3.18 | .300 | 7.62 | .550 | 13.97 |

**90° Narrow Termination
 (/10-15)**



Recommended Board Layout



**(As Viewed from Bottom
 of Terminal Block)**

NOTE: For additional connector dimensions, see page 5-22.

Typ. Hole Dia. = .040" (1.02 mm)

| No. of Contacts | A Max. | | B ± .005 (0.13) | | C Max. | |
|--------------------|-----------|-------|--------------------|-------|-----------|-------|
| | in | mm | in | mm | in | mm |
| 9 Plug | .785 | 19.94 | .565 | 14.35 | .308 | 7.82 |
| 9 Socket | .785 | 19.94 | .565 | 14.35 | .308 | 7.82 |
| 15 Plug | .935 | 23.75 | .715 | 18.16 | .308 | 7.82 |
| 15 Socket | .935 | 23.75 | .715 | 18.16 | .308 | 7.82 |
| 21 Plug | 1.085 | 27.56 | .865 | 21.97 | .308 | 7.82 |
| 21 Socket | 1.085 | 27.56 | .865 | 21.97 | .308 | 7.82 |
| 25 Plug | 1.085 | 30.10 | .965 | 24.51 | .308 | 7.82 |
| 25 Socket | 1.185 | 30.10 | .965 | 24.51 | .308 | 7.82 |
| 31 Plug | 1.335 | 33.91 | 1.115 | 28.32 | .308 | 7.82 |
| 31 Socket | 1.335 | 33.91 | 1.115 | 28.32 | .308 | 7.82 |
| 37 Plug | 1.485 | 37.72 | 1.265 | 32.13 | .308 | 7.82 |
| 37 Socket | 1.485 | 37.72 | 1.265 | 32.13 | .308 | 7.82 |
| 51 Plug | 1.435 | 36.45 | 1.215 | 30.86 | .351 | 8.92 |
| 51 Socket | 1.435 | 36.45 | 1.215 | 30.86 | .351 | 8.92 |
| 100 Plug | 2.175 | 55.25 | 1.800 | 45.72 | .394 | 10.00 |
| 100 Socket | 2.175 | 55.25 | 1.800 | 45.72 | .394 | 10.00 |

| No. of Contacts | F ± .010 (0.25) | | G ± .010 (0.25) | | H Max. | | J ± .005 (0.13) | |
|--------------------|--------------------|------|--------------------|-------|-----------|-------|--------------------|------|
| | in | mm | in | mm | in | mm | in | mm |
| 9 Plug | .230 | 5.84 | .250 | 6.35 | .420 | 10.67 | .096 | 2.44 |
| 9 Socket | .230 | 5.84 | .250 | 6.35 | .420 | 10.67 | .096 | 2.44 |
| 15 Plug | .130 | 3.30 | .250 | 6.35 | .420 | 10.67 | .096 | 2.44 |
| 15 Socket | .130 | 3.30 | .250 | 6.35 | .420 | 10.67 | .096 | 2.44 |
| 21 Plug | .130 | 3.30 | .250 | 6.35 | .420 | 10.67 | .096 | 2.44 |
| 21 Socket | .130 | 3.30 | .250 | 6.35 | .420 | 10.67 | .096 | 2.44 |
| 25 Plug | .130 | 3.30 | .250 | 6.35 | .420 | 10.67 | .096 | 2.44 |
| 25 Socket | .130 | 3.30 | .250 | 6.35 | .420 | 10.67 | .096 | 2.44 |
| 31 Plug | .130 | 3.30 | .250 | 6.35 | .520 | 13.21 | .996 | 2.44 |
| 31 Socket | .130 | 3.30 | .250 | 6.35 | .520 | 13.21 | .096 | 2.44 |
| 37 Plug | .130 | 3.30 | .250 | 6.35 | .520 | 13.21 | .096 | 2.44 |
| 37 Socket | .130 | 3.30 | .250 | 6.35 | .520 | 13.21 | .096 | 2.44 |
| 51 Plug | .150 | 3.81 | .300 | 7.62 | .650 | 16.51 | .096 | 2.44 |
| 51 Socket | .150 | 3.81 | .300 | 7.62 | .650 | 16.51 | .096 | 2.44 |
| 100 Plug | .200 | 5.08 | .400 | 10.16 | 1.000 | 25.40 | .125 | 3.18 |
| 100 Socket | .200 | 5.08 | .400 | 10.16 | 1.000 | 25.40 | .125 | 3.18 |

Mounting Hardware



High Profile Jackscrew



Low Profile Jackscrew



Removable Jackpost

Ordering Information

| Type | Style | Screwhead | Thread | Military Part No. |
|-----------|--------------|--------------|--------|-------------------|
| Jackscrew | Low Profile | Recessed Hex | 2/56 | M83513/5-02 |
| Jackscrew | High Profile | Recessed Hex | 2/56 | M83513/5-03 |
| Jackscrew | Low Profile | Slotted | 2/56 | M83513/5-05 |
| Jackscrew | High Profile | Slotted | 2/56 | M83513/5-06 |
| Jackpost | -- | -- | 2/56 | M83513/5-07 |
| Jackscrew | Low Profile | Hex | 4/40* | M83513/5-12 |
| Jackscrew | High Profile | Hex | 4/40* | M83513/5-13 |
| Jackscrew | Low Profile | Slotted | 4/40* | M83513/5-15 |
| Jackscrew | High Profile | Slotted | 4/40* | M83513/5-16 |
| Jackpost | -- | -- | 4/40* | M83513/5-17 |

*100 Size Only

Dura-Con High Reliability All-Plastic & Metal Shell

.050" (1.27mm) Density
Connector Saver



FEATURES

- Designed to significantly reduce damage to already mounted Dura-Con connectors during routine system tests.
- Eliminates numerous mating & unmating cycles experienced by connectors on test harnesses.
- Plug connector on one end, socket connector on the other.
- Available in all-plastic (polyester) or in metal shell with diallyl phthalate or polyester insulators (both UL94V-0 rated).
- Locking hardware must be ordered separately.

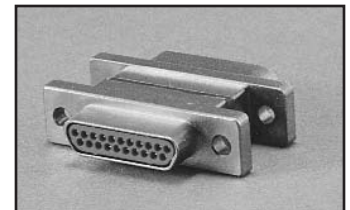
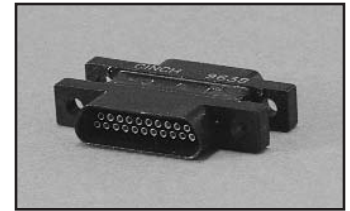

MATERIALS

Insulator: UL94V-0 glass-filled polyester or diallyl phthalate
Contacts: Copper alloy
Contact Plating: .000050 in gold
Shell (Metal Only): Aluminum alloy
Shell Plating: Yellow chromate over cadmium

ENVIRONMENTAL

Operating Temperature: -55°C to +135°C

ELECTRICAL

Current Rating: 3 Amps maximum
Withstanding Voltage: 600 VAC RMS @ sea level
Contact Resistance: 8 milliohms maximum

MECHANICAL

Individual Contact: Insertion force, 6 oz. (170.40 g) maximum;
 Withdrawal force 0.5 oz. (14.20 g) minimum
Mating / Unmating Forces: See previous tables



| No. of Contacts | Metal Shell | | All Plastic |
|--------------------|----------------------------------|---------------------------------------|---------------------------------------|
| | Diallyl Phthalate Catalog No. | Glass-Filled Polyester Catalog No. | Glass-Filled Polyester Catalog No. |
| 9 | DCCM9CS | DCDM9CS | DCDA9CS |
| 15 | DCCM15CS | DCDM15CS | DCDA15CS |
| 21 | DCCM21CS | DCDM21CS | DCDA21CS |
| 25 | DCCM25CS | DCDM25CS | DCDA25CS |
| 31 | DCCM31CS | DCDM31CS | DCDA31CS |
| 37 | DCCM37CS | DCDM37CS | DCDA37CS |
| 51 | DCCM51CS | DCDM51CS | DCDA51CS |
| 100 | DCCM100CS | DCDM100CS | - |

**Dura-Con
High Reliability
Microedge Connectors**

.050" (1.27mm) Density
PC Board Mount
Metal Shell



FEATURES

- **Variety of available PC board mounting styles.**
 - “Coke Bottle” for edge mounting on double-sided PCBs
 - Right-angle (90°) mounting for single- or double-sided daughter boards
 - “Claw Foot” leads
 - Gold-plated solid copper wire pigtails
- **Harnessing capabilities exist for both plug & socket.**
- **Standard sizes are 128 and 184 positions.**
- **Utilizes high-reliability Dura-Con twist pin contact system assuring electrical continuity under extreme shock and vibration.**
- **Aluminum shells and diallyl phthalate insulators make Dura-Con microedge connectors ideal for airborne or space applications.**
- **Microedge metal shell connectors meet the requirement of MIL-C-55302.**

MATERIALS

Insulator: UL94V-0 glass-filled polyester or diallyl phthalate per MIL-M-14 (green)
Contacts: Copper alloy
Contact Plating: .000050 in Gold
Shell: Aluminum alloy
Shell Plating: Electroless Nickel

ENVIRONMENTAL

Operating Temperature: -55°C to +135°C

ELECTRICAL

Current Rating: 3 Amps maximum
Withstanding Voltage: 600 VAC RMS @ sea level, 300 VAC @ 70,000 ft.
Contact Resistance: 8 milliohms maximum

MECHANICAL

Insertion/Withdrawal Force:
 6 oz. (170.40 g[f]) maximum insertion force, per contact;
 0.5 oz. (14.20 g[f]) minimum withdrawal force, per contact

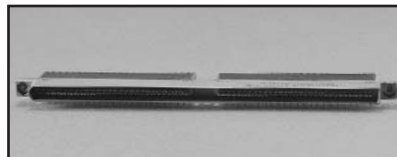

128 Contact Receptacle (Right Angle)



Side View and Termination Grid Pattern



128 Contact Receptacle (Stranded Insulated Wire)



Side View

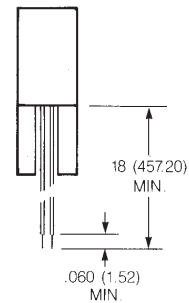

128 Contact Plug (Claw Foot)

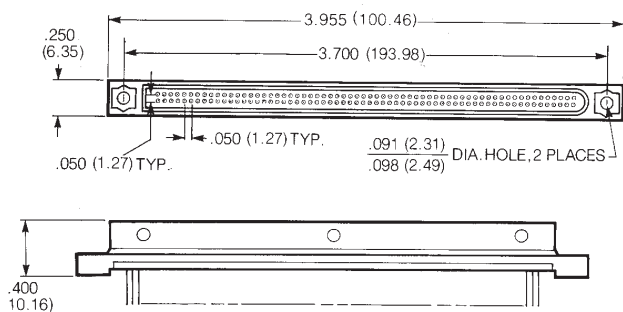

Side View and Termination Grid Pattern

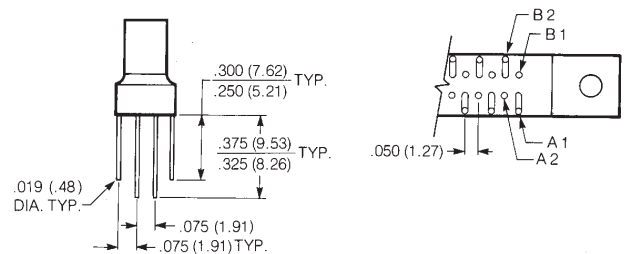

Dura-Con
High Reliability
Microedge Connectors

.050" (1.27mm) Density
 PC Board Mount
 Metal Shell



128 Contact Plug (Stranded Insulated Wire)



Side View



184 Contact Receptacle (Coke Bottle)



Side View



Recommended PCB thickness .047-.062.
 Consult factory for other thicknesses.

184 Contact Receptacle (Stranded Insulated Wire)



Side View



184 Contact Plug (Claw Foot)



Side View and Termination Grid Pattern

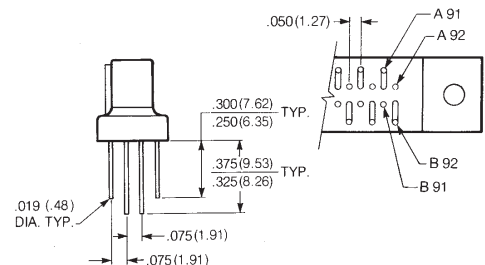

* Narrow Version (DNEB) .250 Wide

5

**Dura-Con
High Reliability
Microedge Connectors**

.050" (1.27mm) Density
PC Board Mount
Metal Shell



184 Contact Plug (Standard Insulated Wire)



Side View



* Narrow Version (DNEB) .250 Wide

Shell Polarization Kit

| Order No. | "L" | Used On |
|-----------|------|------------------|
| DNEBP0L1 | .250 | DNEB Narrow Only |
| DMEBP0L1 | .312 | DMEB Std. Width |

Key



Mounting Hardware

Removable Jackscrew/Jackpost Assembly



Consult factory if required.

Standard Jackscrew/Jackpost Assembly

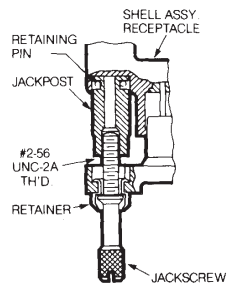

Plug with Jackscrew

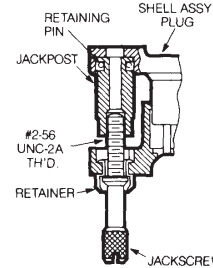

Receptacle with Jackscrew

Ordering Information

DMEB 1-128 P 6 E 2 180

Series Prefix
DMEB = Microedgeboard
DNEB = Microedgeboard, Narrow (184 Only)

Contact Spacing
1 = .050" (1.27mm) centers
128/184
2 = .100" (2.54mm) centers
64/92 (every other contact hole)
For other contact spacing accommodations, consult the factory.

No. of Contacts
128, 184

Contact Type
P = Pin
S = Socket

Wire Size in AWG
5 = 25 AWG Solid Copper
6 = 26 AWG Stranded Wire
S = Solder Cup

*Indicates Cinch std Option

Lead Length in Inches

Termination, Color of Finish
1 = White
*2 = Yellow
3 = Tin-Plated
*4 = Gold-Plated (Solid Copper Wire Only)
*5 = Color Coded per MIL-Std. 681, System 1

Wire Type/Termination Style
C = Solid Copper
E = MIL-W-16878/4, 7 Strand
BS = PC Board (Coke Bottle)
BRA = PC Board Right-Angle (Formed to "A" Side)
BRB = PC Board Right-Angle (Formed to "B" Side)
W = PC Board (Claw Foot)

**Dura-Con
High Reliability
Strip Connectors**

.050" (1.27mm) Density
Solder Cup/Wire
All-Plastic



FEATURES

- *Lightweight.*
- *Slim Profile.*
- *High-Density Interconnect.*
- *High-reliability Dura-Con twist pin contact system for extreme shock & vibration applications.*
- *Optional polarization with guide pins to prevent mismatching connectors.*
- *Plug & socket available in sizes from 1 to 60 positions.*

MATERIALS

Insulator: UL94V-0 glass-filled polyester
Contacts: Copper alloy
Contact Plating: .000050 in gold



ENVIRONMENTAL

Operating Temperature: -55°C to +135°C



ELECTRICAL

Current Rating: 3 Amps maximum
Withstanding Voltage: 600 VAC @ sea level;
150 VAC @ 70,000 ft.
Contact Resistance: 8 milliohms maximum

MECHANICAL

Insertion & Withdrawal Force (Per Contact):
6 oz. (170.40 g[f]) maximum insertion;
0.5 oz. (14.20 g[f]) minimum withdrawal

Dura-Con High Reliability Strip Connectors

.050" (1.27mm) Density
Solder Cup/Wire
All Plastic



Dimensions

Socket Connector



Pin Connector



24 Gauge Stainless Steel Guide Pin*



NOTE: Dimension A is number of positions less 1 multiplied by .050

* Assembly in socket connector only.

Ordering Information



* - Indicates Cinch std. option.

** - Consult factory for larger sizes and multi-row.

Mouser Electronics

Authorized Distributor

Click to View Pricing, Inventory, Delivery & Lifecycle Information:

Cinch Connectivity Solutions:

[DCCM31SCBRPN](#) [DCCM15SBSP](#) [DCCM100PCBRP](#) [DCCM21P6E5-18.0B](#) [DCCM21PCBRPN](#) [DCCM25SCBRP](#)
[DCCM31PBSPN](#) [DCCM31S6E5-36.0B](#) [DCCM37PSBN](#) [DCCM51PSB](#) [DCCM9P6E5-36.0B](#) [DCCM100S6E5-36.0B](#)
[DCCM100SBSP](#) [DCCM15S6E5-18.0BN](#) [DCCM21PSB](#) [DCCM25PCBRPN](#) [DCCM25SBSP](#) [DCCM31S6E5-18.0BN](#)
[DCCM37P6E5-36.0BN](#) [DCCM37SCBRPN](#) [DCCM51SBSP](#) [DCCM9SBSP](#) [DCCM9SSBN](#) [DCCM15P6E5-36.0B](#)
[DCCM15S6E5-36.0B](#) [DCCM21SSB](#) [DCCM25PCBRP](#) [DCCM25S6E5-36.0BN](#) [DCCM31PBSP](#) [DCCM9PBSP](#)
[DCCM9S6E5-36.0BN](#) [DCCM51P6E5-36.0B](#) [DCCM25PBSP](#) [DCCM100PBSP](#) [DCCM100SBSPN](#) [DCCM37P6E5-](#)
[18.0B](#) [DCCM37S6E5-18.0BN](#) [DCCM37SCBRP](#) [DCCM37SSB](#) [DCCM51PCBRP](#) [DCCM51SBSPN](#) [DCCM15P6E5-](#)
[18.0BN](#) [DCCM15P6E5-36.0BN](#) [DCCM15S6E5-36.0BN](#) [DCCM21SCBRPN](#) [DCCM21SSBN](#) [DCCM25PBSPN](#)
[DCCM37P6E5-18.0BN](#) [DCCM37PSB](#) [DCCM37S6E5-18.0B](#) [DCCM37SSBN](#) [DCCM9P6E5-36.0BN](#) [DCCM9PBSPN](#)
[DCCM15S6E5-18.0B](#) [DCCM21P6E5-36.0B](#) [DCCM21SCBRP](#) [DCCM25SBSPN](#) [DCCM25SCBRPN](#) [DCCM31S6E5-](#)
[36.0BN](#) [DCCM37S6E5-36.0BN](#) [DCCM51S6E5-36.0BN](#) [DCCM9PSB](#) [DCCM9S6E5-18.0B](#) [DCCM100S6E5-36.0BN](#)
[DCCM15P6E5-18.0B](#) [DCCM21PBSP](#) [DCCM21PBSPN](#) [DCCM21PCBRP](#) [DCCM25P6E5-36.0B](#) [DCCM25P6E5-](#)
[36.0BN](#) [DCCM25SSB](#) [DCCM51SSBN](#) [DCCM9P6E5-18.0B](#) [DCCM9SBSPN](#) [DCCM9SCBRPN](#) [DCCM100S6E5-](#)
[18.0BN](#) [DCCM15PBSP](#) [DCCM9S6E5-18.0BN](#) [DCCM37PCBRP](#) [DCCM51P6E5-18.0B](#) [DCCM51P6E5-36.0BN](#)
[DCCM51PBSP](#) [DCCM51SSB](#) [DCCM21P6E5-18.0BN](#) [DCCM21S6E5-18.0B](#) [DCCM31P6E5-36.0BN](#) [DCCM31S6E5-](#)
[18.0B](#) [DCCM37P6E5-36.0B](#) [DCCM51SCBRPN](#) [DCCM37PBSPN](#) [DCCM9P6E5-18.0BN](#) [DCCM9SCBRP](#)
[DCCM100PBSPN](#) [DCCM100PCBRPN](#) [DCCM15SSBN](#) [DCCM15SBSPN](#) [DCCM15SCBRP](#) [DCCM37PBSP](#)
[DCCM51S6E5-18.0BN](#) [DCCM51S6E5-36.0B](#)

Компания «Life Electronics» занимается поставками электронных компонентов импортного и отечественного производства от производителей и со складов крупных дистрибьюторов Европы, Америки и Азии.

С конца 2013 года компания активно расширяет линейку поставок компонентов по направлению коаксиальный кабель, кварцевые генераторы и конденсаторы (керамические, пленочные, электролитические), за счёт заключения дистрибьюторских договоров

Мы предлагаем:

- Конкуренспособные цены и скидки постоянным клиентам.
- Специальные условия для постоянных клиентов.
- Подбор аналогов.
- Поставку компонентов в любых объемах, удовлетворяющих вашим потребностям.
- Приемлемые сроки поставки, возможна ускоренная поставка.
- Доставку товара в любую точку России и стран СНГ.
- Комплексную поставку.
- Работу по проектам и поставку образцов.
- Формирование склада под заказчика.
- Сертификаты соответствия на поставляемую продукцию (по желанию клиента).
- Тестирование поставляемой продукции.
- Поставку компонентов, требующих военную и космическую приемку.
- Входной контроль качества.
- Наличие сертификата ISO.

В составе нашей компании организован Конструкторский отдел, призванный помогать разработчикам, и инженерам.

Конструкторский отдел помогает осуществить:

- Регистрацию проекта у производителя компонентов.
- Техническую поддержку проекта.
- Защиту от снятия компонента с производства.
- Оценку стоимости проекта по компонентам.
- Изготовление тестовой платы монтаж и пусконаладочные работы.



Тел: +7 (812) 336 43 04 (многоканальный)
Email: org@lifeelectronics.ru