

MIL-T-81714 Series II Composite Termination System

INCLUDING DEUTSCH SOCKET CONTACTS

Mil-Spec Connectors & Accessories



DEUTSCH COMPOSITE
TERMINATION SYSTEM (CTS)

| | |
|------|------|
| CTD | CTL |
| CTJ1 | CTM |
| CTJ2 | CTN |
| CTJ7 | CTJ4 |
| CTG | |

DEUTSCH ECD

Defense / Aerospace Operations ...

is the world's premier manufacturer of electrical interconnection devices for use in defense, aerospace, and commercial applications. Whether you need an interconnection device for a commercial or military aircraft, missile, tank, truck transmission or a host of other applications, Deutsch has the solution you're looking for.

Deutsch ECD Defense Aerospace Operations

5733 W. Whittier Ave., Hemet CA (USA) 92545
Phone 909/765-2200 • FAX 909/922-1544

Composite Termination System Common Termination System

The Common Termination System consists of a system of wires and components that are interconnected to one another by the use of a standard MIL-C-39029/22 socket contact only. This eliminates the need for pin contacts which are located in the mating components. There are approximately twenty different devices that comprise the Common Termination System. These devices consist of modules, junctions, connectors, and rail assemblies, including:



Feedback Modules:

Act like a terminal strip. Each module accommodates a single contact size which is busied internally to a copper bar.

Distribution Modules:

Used when two or more contact sizes are needed per module. The buss bars are also forged from a single copper piece.

Grounding Modules:

Developed to provide multiple grounds made at a common point. This is a feedback module grounded to structure.

Component Modules:

Provide a method of terminating wires to printed circuit boards, tape, and flat cable.

Electronic Modules:

Designed to contain a variety of circuit arrangements for rectifying, filtering, and arc suppression.

Plug and Receptacle Modules:

Designed for applications involving the simultaneous connection and disconnection of groups of wires. The receptacle module can also contain pins extended from the rear grommet to accept flat cable.

Common Termination Cylindrical & Rectangular Connectors:

Designed with the socket contacts contained in the receptacle which are fixed with pin contacts in the termination end (rear grommet). Inserts are designed to MIL-C-38999, and termination is accomplished by utilization of the socket contacts designed to MIL-C-39029/22.

Grounding Junctions:

Provide a simple method of terminating a wire (22, 20, 16, and 12 AWG) to ground. Wires with crimp contacts are inserted into the grounding junction and can be attached to any conductive surface.

In-Line Junctions:

Used to join two wires. Similar to an in-line splice, but removable.

Multi Junctions:

Designed to join four wires. Similar to two in-line junctions busied together.

Module Rails:

Designed to accommodate various modules which can be individually snapped in and out.

This standardization of terminations for all system components simplifies training, saves assembly time, cuts production cost, speeds up procurement, reduces weight, and enhances performance.

This information is for reference only. Consult factory for envelope drawings, updated specifications, and additions to the product line.



Composite Termination System

CTD Series, CTJ1 Series

Power Distribution and Feedback Modules for applications that require bussing a variety of wire and contact sizes.



The Deutsch composite system uses a rugged socket contact terminated to internal pin-buss bars.

The Deutsch CTD series module accents a large input current and distributes it through a pin-buss system to smaller feeder terminal strips and can be pre-wired to simplify final assembly.

The Deutsch CTJ1 series modules accommodates common bussing of 6 to 20 contacts in a small area. Internal bussbars are configured to allow connections of various combinations of wires providing environmental resistance and vibration dampening.

Dielectric Withstanding Voltage

(MIL-T-81714, paragraph 3.5.6)
At sea level: 1500 Volts AC (RMS)
At 110,000 ft.: 200 Volts AC (RMS)

Insulation Resistance

(MIL-T-81714, paragraph 3.5.11)
5000 megohms min. at 25°C.

Thermal Shock

(MIL-T-81714, paragraph 3.5.5)
After cycling the modules between -55°C and +200°C, they will meet all applicable electrical and mechanical requirements.

Current Rating

(Meets MIL-C-39029, paragraph 3.5.4)

| Contact Size | Max. Amps |
|--------------|-----------|
| 22 | 5 |
| 20 | 7.5 |
| 16 | 13 |
| 12 | 23 |

Temperature

(MIL-T-81714)
Operative at temperatures from -65°C to +200°C.

Corrosion

(MIL-T-81714, paragraph 3.5.12)

Vibration

(MIL-T-81714, paragraph 3.5.8)
Maintains continuity and exhibits no mechanical or physical damage during or after vibration levels stated in listed specification.

SPECIFICATIONS

Usable Wire Size

(MIL-C-39029, paragraph 3.4.2)

| Contact Size | Accepts (AWG) |
|--------------|---------------|
| 22 | 22-26 |
| 20 | 20-24 |
| 16 | 16-20 |
| 12 | 12 & 14 |

Grommet Sealing Range

(MIL-T-81714, Table I)

| Contact Size | Max. Wire O.D. | Min. Wire O.D. |
|--------------|----------------|----------------|
| 22 | .060 | .030 |
| 20 | .083 | .040 |
| 16 | .109 | .065 |
| 12 | .142 | .097 |

Fluid Compatibility

Designed to function in many fluids encountered in most modern military or aerospace environments. Available with options to operate in the following fluid environments in accordance with MIL-T-81714.

| Classification | Fluid* |
|----------------|----------------------------|
| MIL-H-5606 | Aircraft Hydraulic Fluid |
| MIL-T-5624 | JP-5 Jet Fuel |
| MIL-L-7808 | Lubricating Oil |
| MIL-L-23699 | Lubricating Oil |
| MIL-A-8243 | Defrosting Fluid |
| MIL-C-25769 | Alkaline Cleaning Compound |
| MIL-G-3056 | Gasoline |

* Also: Isopropyl Alcohol, Mineral Spirits, 1-1-1 Trichloroethane, Freon TMC.

This information is for reference only. Consult factory for envelope drawings, updated specifications, and additions to the product line.



CTD

DISTRIBUTION BUSSING ARRANGEMENTS

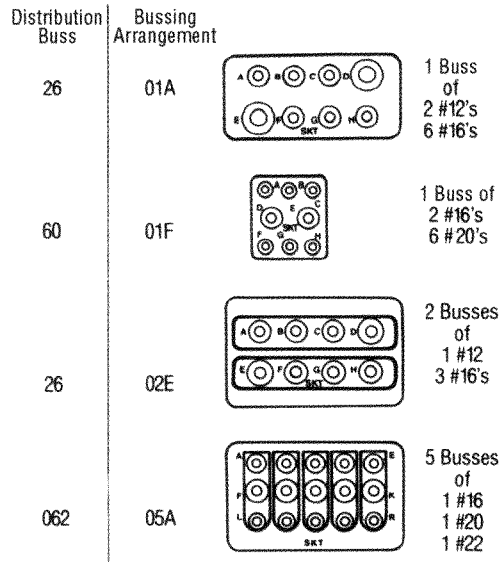

OUTLINE DIMENSIONS

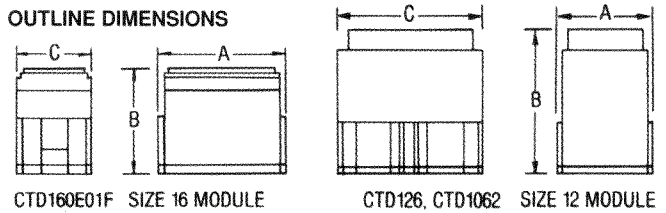

| Part No. | Contact Quantity & Size | A ± 0.15 | B Max. | C ± 0.30 |
|-------------|-------------------------|----------|--------|----------|
| CTD126E01A | 2 Size 12 & 6 Size 16 | .672 | 1.047 | 1.020 |
| CTD160E01F | 2 Size 16 & 6 Size 10 | .672 | .920 | .510 |
| CTD126E02E | 2 Size 12 & 6 Size 16 | .672 | 1.047 | 1.020 |
| CTD1062E05A | 5 Size 16, 20 & 22 | .672 | .920 | 1.020 |

ORDERING INFORMATION

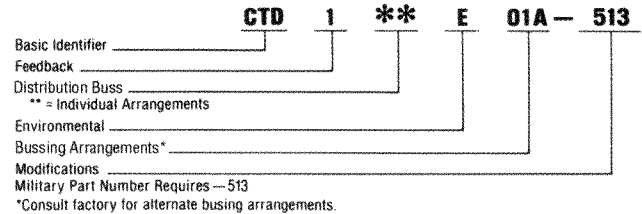

CTJ (Feedback Module)

BUSSING ARRANGEMENTS

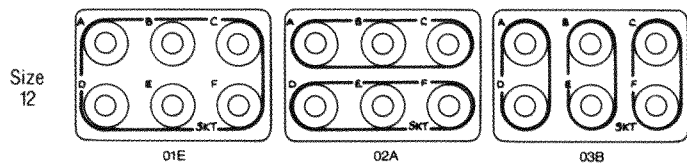
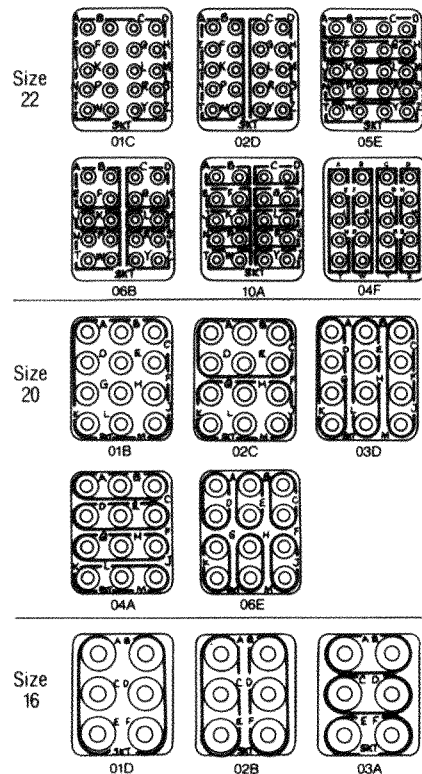

OUTLINE DIMENSIONS

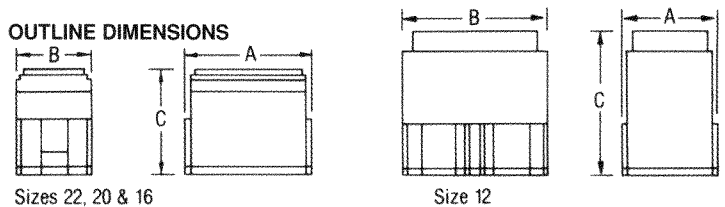

| Module Size | A ± 0.15 | B ± 0.30 | C Max. | Module *Weight/lbs |
|-------------|----------|----------|--------|--------------------|
| 22 | .672 | .510 | .760 | 0.01036 |
| 20 | .672 | .510 | .920 | 0.01560 |
| 16 | .672 | .510 | .920 | 0.01560 |
| 12 | .672 | 1.020 | 1.047 | 0.02733 |

*Less Contacts

ORDERING INFORMATION

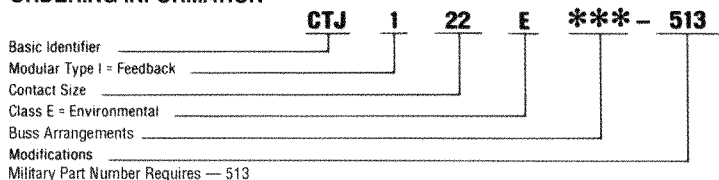

Deutsch Metal Rail
ASSEMBLY DIMENSIONS



| Frame Length | Frame Capacity | | A ±.015 | B ±.010 | Rail Weight/lbs. |
|--------------|----------------|-----|---------|---------|------------------|
| | 22, 20, 16 | 12 | | | |
| 02 | 2 | 1** | 1.036 | .518 | .022 |
| 03 | 3 | 1** | 1.554 | 1.036 | .033 |
| 04 | 4 | 2 | 2.072 | 1.554 | .043 |
| 05 | 5 | 2** | 2.590 | 2.072 | .054 |
| 06 | 6 | 3 | 3.108 | 2.590 | .065 |
| 07 | 7 | 3** | 3.626 | 3.108 | .075 |
| 08 | 8 | 4 | 4.144 | 3.626 | .086 |
| 09 | 9 | 4** | 4.662 | 4.144 | .097 |
| 10 | 10 | 5 | 5.180 | 4.662 | .108 |
| 12 | 12 | 6 | 6.216 | 5.698 | .130 |

(Longer rail sizes also available, consult the factory)
*Consult factory for availability of these finishes.
**Size includes room for one or more size 22, 20, or 16 modules.

ORDERING INFORMATION



ORDERING INFORMATION

CTJ-2D-01 Single Module Metal Rail



Single Full Module (or double half module) acceptance

NOTE: Dimensions are in inches unless otherwise specified

Consult the Deutsch factory for availability of finishes other than specified

Deutsch Composite Rail

The Deutsch Composite Rail provides a lightweight, corrosion-proof mounting system for electronic, feedback and distribution modules. It is designed to allow hand insertion of each individual module. A positive lock retains the module in the rail. Modules can be individually unlocked and removed by using a simple tool. The Deutsch Composite Rail uses advanced materials and processes with field-proven technology to reduce weight while exceeding performance parameters.

COMPOSITE RAIL FEATURES & BENEFITS

- 48% lighter than comparable aluminum rails.
- Intermounts with MIL-T-81714 Series II rails.
- Extreme operating temperatures (-65°C +175°C).
- Corrosion-proof.
- Common removal tooling.
- Accepts MIL-T-81714 Series II modules.



| ** | A ±.015 | B ±.010 | WEIGHT (gm.) | WEIGHT (oz.) |
|----|---------|---------|--------------|--------------|
| 02 | 1.036 | .518 | 5.30 | .19 |
| 03 | 1.554 | 1.036 | 7.95 | .28 |
| 04 | 2.072 | 1.554 | 10.60 | .37 |
| 05 | 2.590 | 2.072 | 13.25 | .47 |
| 06 | 3.108 | 2.590 | 15.90 | .56 |
| 07 | 3.626 | 3.108 | 18.55 | .65 |
| 08 | 4.144 | 3.626 | 21.20 | .75 |
| 09 | 4.662 | 4.144 | 23.85 | .84 |
| 10 | 5.180 | 4.662 | 26.50 | .93 |
| 11 | 5.698 | 5.180 | 29.15 | 1.03 |
| 12 | 6.216 | 5.698 | 31.80 | 1.12 |
| 13 | 6.734 | 6.216 | 34.45 | 1.21 |
| 14 | 7.252 | 6.734 | 37.10 | 1.31 |
| 15 | 7.770 | 7.252 | 39.75 | 1.40 |
| 16 | 8.288 | 7.770 | 42.40 | 1.50 |
| 17 | 8.806 | 8.288 | 45.05 | 1.59 |
| 18 | 9.324 | 8.806 | 47.70 | 1.68 |
| 19 | 9.842 | 9.324 | 50.35 | 1.78 |
| 20 | 10.360 | 9.842 | 53.00 | 1.87 |

NOTE: Dimensions are in inches unless otherwise specified.

Ordering Information



Composite Termination System

CTJ7 Series, CTG Series

Grounding modules for grounding applications that need a small, rugged device that also offers sealing and assembly ease.



The Deutsch Common Termination Junction Series Grounding Module provides an excellent method of grounding multiple wires to a common location. It accepts M39029/22 crimp-type sockets that mate with internal pins on a rugged buss bar contained in a sealed plastic housing. The one-piece construction is small, lightweight, dissipates heat, is shock and vibration resistant, and has an extremely low voltage drop.

For grounding single wires, the Deutsch Common Termination Grounding Series adapter, a threaded stud mounting junction, accepts a single M39029/22 socket contact. It, too, has an environmental seal. It can also be used to adapt any electro-mechanical component using screw type terminations. (The threaded stud can replace the screw terminals.)

Dielectric Withstanding Voltage

(Meets AFLC 8027520, paragraph 3.10)
At sea level: 1500 Volts AC (RMS)
At 100,000 ft.: 200 Volts AC (RMS)

Insulation Resistance

(Meets AFLC 8027520, paragraph 3.9)
500 megohms min. at 25°C.

Thermal Shock

(Meets AFLC 8027520, paragraph 3.7)
After cycling the header between -55°C and +200°C, it will meet all applicable electrical and mechanical requirements.

Current Rating

(Meets MIL-C-39029, paragraph 3.5.4)

| Contact Size | Max. Amps |
|--------------|-----------|
| 22 | 5 |
| 20 | 7.5 |
| 16 | 13 |
| 12 | 23 |

Temperature

(Meets AFLC 8027520, paragraph 1.2.1)
Operative at temperatures from -65°C to +200°C.

Physical Shock

(Meets AFLC 8027520, paragraph 3.20)
No loosening of parts, cracking, or other deleterious results hindering further part operation after 78 G's in each of 3 mutually perpendicular planes.

Corrosion

(Meets AFLC 8027520, paragraph 3.11)
No decrease in performance or exposure of base metal after 48 hours of salt spray.

Humidity

(Meets requirements of AFLC 8027520, paragraph 3.21, for resistance to humidity.)

Magnetic Permeability

(Meets AFLC 8027520, paragraph 3.3.3)
Maximum of 2.0μ magnetic permeability.

SPECIFICATIONS

Vibration

(Meets AFLC 8027520, paragraph 3.19)
Maintains continuity and exhibits no mechanical or physical damage during or after the following vibration levels.

Level I — duration: 34 minutes per axis

| | |
|----------|-----------------------------|
| 20-90 | Hz at 6dB/oct. rise |
| 90-300 | Hz at 1.0g ² /Hz |
| 300-2000 | Hz at 6dB/oct. fall |

Level II — duration: 14 minutes per axis

| | |
|----------|-----------------------------|
| 20-40 | Hz at 6dB/oct. rise |
| 40-350 | Hz at 0.5g ² /Hz |
| 350-2000 | Hz at 6dB/oct. fall |

No discontinuities greater than 1 microsecond.

Contact Resistance at 25°C

(Meets MIL-C-39029 paragraph 3.5.4)

| Wire (AWG) | Test Current (Amps) | Millivolt Drop (*) |
|------------|---------------------|--------------------|
| 26 | 2 | 53 |
| 22 | 5 | 73 |
| 20 | 7.5 | 55 |
| 16 | 13 | 50 |
| 12 | 23 | 42 |

(*) less drop through wire

Usable Wire Size

(Meets AFLC 8027520, paragraph 3.4.3.1)

| Contact Size | Accepts (AWG) |
|--------------|---------------|
| 22 | 22-26 |
| 20 | 20-24 |
| 16 | 16-20 |
| 12 | 12 & 14 |

Grommet Sealing Range

(Meets AFLC 8027520, paragraph 3.4.3.1)

| Contact Size | Max. Wire O.D. | Min. Wire O.D. |
|--------------|----------------|----------------|
| 22 | .060 | .030 |
| 20 | .083 | .040 |
| 16 | .109 | .065 |
| 12 | .142 | .097 |

Fluid Compatibility

(Meets AFLC 8027520, paragraph 1.2.9)

Designed to function in all fluids encountered in any modern military or aerospace environment. Available with options to operate in the following fluid environments.

| Classification | Fluid* |
|----------------|----------------------------|
| MIL-H-5606 | Aircraft Hydraulic Fluid |
| MIL-T-5624 | JP-5 Jet Fuel |
| MIL-L-7808 | Lubricating Oil |
| MIL-L-23699 | Lubricating Oil |
| MIL-A-8243 | Defrosting Fluid |
| MIL-C-25769 | Alkaline Cleaning Compound |
| MIL-G-3056 | Gasoline |

* Also: Isopropyl Alcohol, Mineral Spirits, 1-1-1 Trichloroethane, Freon TMC, Methylene Chloride.



Composite Termination System

CTJ7 Series, CTG Series

CTJ7

OUTLINE DIMENSIONS



| Part No. | Size | A ±.015 | B ±.015 | C Max. | D ±.015 | E Ref. | F Max. | G ±.004 | H ±.002 | J Max. | K Thread |
|------------|------|---|------------|-----------|------------|-----------|-----------|------------|------------|-----------|-------------|
| CTJ722*01C | 22 | .580 | .740 | .830 | .350 | .353 | .125 | .205 | .340 | .830 | 10-32 UNF |
| CTJ720*01B | 20 | .580 | .740 | .995 | .350 | .353 | .125 | .205 | .340 | .955 | 10-32 UNF |
| CTJ716*01D | 16 | .580 | .740 | .995 | .350 | .353 | .125 | .205 | .340 | .955 | 10-32 UNF |
| CTJ712*01E | 12 | See drawing above for dimensions. No size 12 in stud mtg. | | | | | | | | | |



CTJ7
BUSSING ARRANGEMENTS



01C SIZE 22



01B SIZE 20



01D SIZE 16



01E SIZE 12

CTJ7
ORDERING INFORMATION



CTG
OUTLINE DIMENSIONS



Parts are supplied with washer.

| Part Number | Contact Size | A ± .031 | B ± .015 | Wire sealing range (smooth insulation O.D.) |
|-------------|--------------|----------|----------|---|
| CTG-22-08 | 22 | 1.311 | .188 | .030-.060 |
| CTG-20-08 | 20 | 1.240 | .188 | .040-.083 |
| CTG-16-08 | 16 | 1.246 | .250 | .068-.109 |
| CTG-12-08 | 12 | .1370 | .313 | .097-.142 |

CTG
ORDERING INFORMATION



Composite Termination System

CTL Series, CTM Series, CTN Series

In-line Junctions for connecting two to four wires in-line, and multi-junctions for housing and sealing individual components.



The Deutsch In-Line Junction (CTL) is used to connect two wires in-line utilizing crimp-type contacts. The junction can then be placed in a wire bundle without being mounted.

The Multi-Junction (CTM) connects and busses four wires. It can be used to replace "Y" splices and terminal strips.

The Electronic Multi-Junction (CTN) is an in-line device that houses and shields any passive or active components, including fuses, resistors, diodes, capacitors, etc.

Dielectric Withstanding Voltage

(MIL-T-81714, paragraph 3.5.6)
At sea level: 1500 Volts AC (RMS)
At 110,000 ft.: 200 Volts AC (RMS)

Insulation Resistance

(MIL-T-81714, paragraph 3.5.11)
5000 megohms min. at 25°C.

Current Rating

(Meets MIL-C-39029)

| Contact Size | Max. Amps |
|--------------|-----------|
| 22 | 5 |
| 20 | 7.5 |
| 16 | 13 |
| 12 | 23 |

Temperature

(MIL-T-81714)
Operative at temperatures from -65°C to +200°C.

Physical Shock

(MIL-T-81714 paragraph 3.5.9)
Items shall not be damaged and there shall be no loosening of parts due to shock. There shall be no interruption of electrical continuity longer than one microsecond during the exposure to mechanical shock.

Corrosion

(MIL-T-81714, paragraph 3.5.12)
Salt Spray. Components shall show no exposure of basis metal due to corrosion that will affect performance, when tested.

Vibration

(MIL-T-81714, paragraph 3.5.8)
Items furnished under this specification shall not be damaged and there shall be no loosening of parts due to vibration. There shall be no interruption of electrical continuity longer than one microsecond in duration during the vibration test.

SPECIFICATIONS

Grommet Sealing Range (MIL-T-81714, Table I)

| Contact Size | Max. Wire O.D. | Min. Wire O.D. |
|--------------|----------------|----------------|
| 22 | .060 | .030 |
| 20 | .083 | .040 |
| 16 | .109 | .065 |
| 12 | .142 | .097 |

Fluid Compatibility

Designed to function in many fluids encountered in most modern military or aerospace environments. Available with options to operate in the following fluid environments, in accordance with MIL-T-81714.

| Classification | Fluid* |
|----------------|----------------------------|
| MIL-H-5606 | Aircraft Hydraulic Fluid |
| MIL-T-5624 | JP-5 Jet Fuel |
| MIL-L-7808 | Lubricating Oil |
| MIL-L-23699 | Lubricating Oil |
| MIL-A-8243 | Defrosting Fluid |
| MIL-C-25769 | Alkaline Cleaning Compound |
| MIL-G-3056 | Gasoline |

*Also: Isopropyl Alcohol, Mineral Spirits, 1-1 Trichloroethane, Freon TMC.



Composite Termination System

CTL/CTM/CTN Series

CTL OUTLINE DIMENSIONS



SIZE 12, 16, 20 & 22



| Part No. | Size | A Max. | B ±.030 |
|----------|------|--------|---------|
| CTL-22 | 22 | 1.280 | .200 |
| CTL-20 | 20 | 1.452 | .260 |
| CTL-16 | 16 | 1.400 | .300 |
| CTL-12 | 12 | 1.680 | .360 |

ORDERING INFORMATION



CTM OUTLINE DIMENSIONS



Terminals (contact)

| Part No. | Size | A ±.060 | B ±.030 | C ±.030 |
|----------|------|---------|---------|---------|
| CTM 22 | 22 | 1.262 | .354 | .210 |
| CTM 20 | 20 | 1.368 | .451 | .241 |
| CTM 16 | 16 | 1.368 | .518 | .274 |
| CTM 12 | 12 | 1.644 | .644 | .337 |

ORDERING INFORMATION

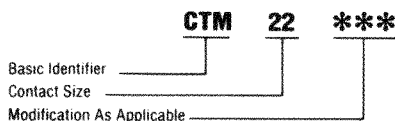

CTN LAYOUT ARRANGEMENTS

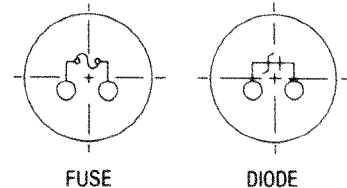

OUTLINE DIMENSIONS

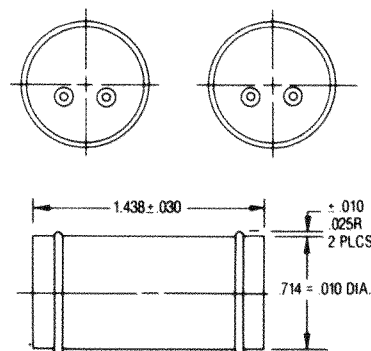

Components are electrically connected between contact tubes

Example:

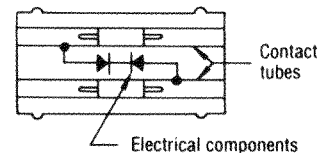

Ordering Information



*For component availability, contact factory.

NOTE: As module performance may be limited by electronic components utilized, applications should be carefully investigated before using.



Composite Termination System

CTJ4 Series

Electronic Component Module that offers crimp-tool terminations and a housing system for discrete components and circuits.



Each Deutsch Electronic Component Module houses small printed circuit boards incorporating diodes, resistors, capacitors, relays, fuses, etc. The input/output wiring is sealed with a silicone rubber grommet. This packaging technique allows designers to include circuits in a system that would be considered environmentally hazardous. For example, transient suppression devices can be placed in or near the system or harness they were designed to protect. Other applications include rectifying, filtering, voltage clamping, and arc-suppression.

Dielectric Withstanding Voltage*

(MIL-T-81714, paragraph 3.5.6)
 At sea level: 1500 Volts AC (RMS)
 At 100,000 ft.: 200 Volts AC (RMS)

Thermal Shock*

(MIL-T-81714, paragraph 3.5.5)
 After cycling the modules between -55°C and +200°C, they will meet all applicable electrical and mechanical requirements.

Current Rating*

(Exceeds MIL-C-39029)

| Contact Size | Max. Amps |
|--------------|-----------|
| 20 | 7.5 |
| 12 | 23 |

Temperature*

(MIL-T-81714)
 Operative at temperatures from -65°C to +125°C**

Vibration*

(MIL-T-81714, paragraph 3.5.8)

Usable Wire Size

(MIL-C-39029, paragraph 3.4.2)

| Contact Size | Accepts (AWG) |
|--------------|---------------|
| 20 | 20-24 |
| 12 | 12 & 14 |

SPECIFICATIONS

Grommet Sealing Range

(MIL-C-39029, paragraph 3.4.2)

| Contact Size | Max. Wire O.D. | Min. Wire O.D. |
|--------------|----------------|----------------|
| 20 | .083 | .040 |
| 12 | .142 | .097 |

Fluid Compatibility

Designed to function in most fluids encountered in many modern military or aerospace environments. Available with options to operate in the following fluid environments.

(MIL-T-81714, paragraph 4.6.7)

| Classification | Fluid* |
|----------------|----------------------------|
| MIL-H-5606 | Aircraft Hydraulic Fluid |
| MIL-T-5624 | JP-5 Jet Fuel |
| MIL-L-7808 | Lubricating Oil |
| MIL-L-23699 | Lubricating Oil |
| MIL-A-8243 | Defrosting Fluid |
| MIL-C-25769 | Alkaline Cleaning Compound |
| MIL-G-3056 | Gasoline |

*Also: Isopropyl Alcohol, Mineral Spirits, 1-1-1 Trichloroethane, Freon TMC.

*The indicated performance values are given for general design information but may require adjustments due to applicable electronic component sensitivity

**Limited by component



Composite Termination System

CTJ4 Series

Typical Internal Circuit Diagrams

The figures are typical of the many standard configurations offered. Custom configurations are also available. Consult Deutsch for additional configurations.



| 002 | | |
|------|-------------|---------------|
| Qty. | Description | Type |
| 5 | Resistors | 150 Ohms Each |



| 005 | | |
|------|-------------|--------|
| Qty. | Description | Type |
| 5 | Diodes | 1N4246 |



| 009 | | |
|------|-------------|--------|
| Qty. | Description | Type |
| 6 | Diodes | 1N5618 |



| 017 | | |
|------|-------------|--------|
| Qty. | Description | Type |
| 1 | Zener Diode | 1N4478 |
| 1 | Diode | 1N5618 |



| 027 | | |
|------|-------------------------|-------|
| Qty. | Description | Type |
| 2 | Iso-Cubes Relay Circuit | 801-1 |

*Consult factory for additional layouts.

Ordering Information



Composite Termination System

Socket Contacts

The most rugged Contact in the Industry designed to MIL-C-39029/22



The Deutsch Composite System is designed to use MIL-C-39029/22 contacts. These Deutsch contacts are designed with a protected or hooded entry providing increased durability during handling. Actual termination to the wire is accomplished by crimping, thus insuring reliability.

Reduced crimp barrel diameters are available to accommodate a variety of wire sizes. These contacts can be provided with extended life plating. Consult factory for further information.

Inside each composite module is a high technology cold extruded pin type bussbar. As each socket contact is inserted into a composite component it mates with this extruded pin allowing "pin and socket" engagement.

STANDARD CONTACT DIMENSIONS



| Size | Contact Part No | Equivalent Military Part No | Color Bands | | | A Max. | B Dia. | C Max. | D Min. | E Max. | Weight (Lbs.) |
|------|-----------------|-----------------------------|-------------|-------|--------|--------|-----------|--------|--------|--------|---------------|
| | | | 1st | 2nd | 3rd | | | | | | |
| 22 | CTS-S22/22 | M39029/22-191 | Brown | White | Brown | .336 | .033/.031 | .0615 | .033 | .048 | .00011 |
| 20 | CTS-S20/20 | M39029/22-192 | Brown | White | Red | .358 | .044/.042 | .094 | .046 | .070 | .00027 |
| 16 | CTS-S16/16 | M39029/22-193 | Brown | White | Orange | .358 | .064/.066 | .130 | .066 | .103 | .00050 |
| 12 | CTS-S12/12 | M39029/22-605 | Blue | Black | Green | .455 | .100/.097 | .171 | .096 | .152 | .00145 |

| Size | Wire Gauge | Crimp Tool | Crimp Tool Positioner | Strip Length | Insertion & Extraction Tool | Unwired Removal Tool |
|------|------------|---------------------|-----------------------|--------------|-----------------------------|----------------------|
| | | | | | | |
| 20 | 20-24 | MH860 (M22520/7-01) | 86-20 (M22520/7-12) | .207 ± .030 | M15570-20 | M15574-20 |
| 16 | 16-20 | MH860 (M22520/7-01) | 86-21 (M22520/7-13) | .207 ± .030 | M15570-16 | M15574-16 |
| 12 | 12 & 14 | AF8 (M22520/1-01) | M22520/1-16 | .225 ± .020 | 81515-12 | M15574-16 |

REDUCED CRIMP BARREL (crimp type)



1. Body Material: Per MIL-C-39029, Type A
2. Body Finish: Gold per MIL-G-45204, Type II, Class 1, over a suitable underplating, excluding silver.

| Size | Contact Part No. | Color Bands | | A Max. | B Dia. | C Max. | D Min. | E Max. | Max. Weight (Lbs.) | Wire Gauge |
|------|------------------|-------------|-------|--------|-----------|--------|--------|--------|--------------------|------------|
| | | 1st | 2nd | | | | | | | |
| 20 | 1662-202-2031 | RED | GREEN | .358 | .044/.042 | .094 | .033 | .050 | .00027 | 22 thru 26 |
| 16 | 1662-202-1631 | BLUE | RED | .358 | .064/.066 | .130 | .046 | .070 | .00050 | 20 thru 24 |
| 12 | 1662-202-1231 | YELLOW | BLUE | .460 | .100/.097 | .171 | .066 | .103 | .00145 | 16 thru 20 |

| Size | Crimp Tool | Crimp Tool Positioner | Setting Wire Size | Strip Length | Insertion & Extraction Tool | Unwired Removal Tool | | | | | | | | | |
|------|-------------|-----------------------|-------------------|--------------|-----------------------------|----------------------|----|-------------|-----------|----|----|----|-------------|-----------|-----------|
| | | | | | | | 16 | 18 | 20 | 22 | 24 | 26 | | | |
| | | | | | | | 20 | M22520/1-01 | TH343 RED | | | | | | |
| 16 | M22520/1-01 | TH343 BLUE | | | | | | | | | | | .207 ± .030 | M15570-16 | M15574-20 |
| 12 | M22520/1-01 | TH343 YELLOW | 6 | 5 | 4 | | | | | | | | .225 ± .020 | 81515-12 | M15574-16 |



Composite Termination System

Socket Contacts

Thermal Shock

(Meets MIL-C-39029, paragraph 3.5.6)

Temperature

(Meets MIL-C-39029, paragraph 1.2.2.)
Operative at temperatures from -65°C to +200°C.

Current Rating

(Meets MIL-C-39029)

| Contact Size | Max. Amps |
|--------------|-----------|
| 22 | 5 |
| 20 | 7.5 |
| 16 | 13 |
| 12 | 23 |

Physical Shock

(Meets MIL-C-39029, paragraph 3.5.11)

Vibration

(Meets MIL-C-39029, paragraph 3.5.10)

REDUCED DIAMETER CONTACT ORDERING INFORMATION

| Contact Size | Deutsch Part No. |
|--------------|------------------|
| 20 | 1662-202-2031 |
| 16 | 1662-202-1631 |
| 12 | 1662-202-1231 |

ASSEMBLY TOOLS Wire/contact assembly tools are standard military type insertion/removal tools found in most assembly areas.



STANDARD CONTACT TOOLS ORDERING INFORMATION

| Contact Size | Insertion/ Removal Tool | Crimp Tool | Crimp Tool Positioner | Sealing Plug |
|--------------|---------------------------|-------------|-----------------------|--------------|
| 22 | 81515-23 | M22520/7-01 | M22520/7-11 | 1613-03-2205 |
| 20 | M15570-20 M81969/14-11 | M22520/7-01 | M22520/7-12 | 81539-20 |
| 16 | M15570-16 M81969/14-03 | M22520/7-01 | M22520/7-13 | 81539-16 |
| 12 | 81515-12 | M22520/1-01 | M22520/1-16 | 81539-12 |

CONTACT DIMENSIONS



| Size | Contact Part No | Equivalent Military Part No. | Color Bands | | | A Max. | B Dia. | C Max. | D Min. | E Max. | Weight (Lbs.) |
|------|-----------------|------------------------------|-------------|-------|--------|--------|------------|--------|--------|--------|---------------|
| | | | 1st | 2nd | 3rd | | | | | | |
| 22 | CTS-S22/22 | M39029/22-191 | Brown | White | Brown | .336 | .033/ .031 | .0615 | .033 | .048 | .00011 |
| 20 | CTS-S20/20 | M39029/22-192 | Brown | White | Red | .358 | .044/ .042 | .094 | .046 | .070 | .00027 |
| 16 | CTS-S16/16 | M39029/22-193 | Brown | White | Orange | .358 | .064/ .066 | .130 | .066 | .103 | .00050 |
| 12 | CTS-S12/12 | M39029/22-605 | Blue | Black | Green | .455 | .100/ .097 | .171 | .096 | .152 | .00145 |

| Wire Size | Wire Gauge | Crimp Tool | Crimp Tool Positioner | Strip Length | Insertion & Extraction Tool | Unwired Removal Tool |
|-----------|------------|---------------------|-----------------------|--------------|-----------------------------|----------------------|
| 22 | 22-26 | MH860 (M22520/7-01) | 86-19 (M22520/7-11) | 207 ± 030 | 81515-23 | 81517-23 |
| 20 | 20-24 | MH860 (M22520/7-01) | 86-20 (M22520/7-12) | 207 ± 030 | M15570-20 | M15574-20 |
| 16 | 16-20 | MH860 (M22520/7-01) | 86-21 (M22520/7-13) | 207 ± 030 | M15570-16 | M15574-16 |
| 12 | 12 & 14 | AF8 (M22520/1-01) | M22520/1-16 | 225 ± 020 | 81515-12 | M15574-16 |



Part Number Cross Reference

Composite Termination System MIL-T-81714E Series II

QPL Authorization NAC 29.13/02-13-89

| Government Designation | Deutsch Designation | Government Designation | Deutsch Designation |
|------------------------|---------------------|------------------------|---------------------|
| M81714/60-12-01 | CTJ112E01E-513 | M81714/64-12 | CTG-12-08-513 |
| 02 | 02A | 16 | 16-08 |
| 03 | 03B | 20 | 20-08 |
| 16-01 | CTJ116E01D-513 | 22 | 22-08 |
| 02 | 02B | M81714/65-12-1 | CTL-12-513 |
| 03 | 03A | 12-2 | CTM-12-513 |
| 20-01 | CTJ120E01B-513 | 16-1 | CTL-16-513 |
| 02 | 02C | 16-2 | CTM-16-513 |
| 03 | 03D | 20-1 | CTL-20-513 |
| 04 | 04A | 20-2 | CTM-20-513 |
| 06 | 06E | 22-1 | CTL-22-513 |
| 22-01 | CTJ122E01C-513 | 22-2 | CTM-22-513 |
| 02 | 02D | M81714/67-02 | CTJ-3A-02-4032 |
| 04 | 04F | 03 | 03 |
| 05 | 05E | 04 | 04 |
| 06 | 06B | 05 | 05 |
| 10 | 10A | 06 | 06 |
| M81714/61-0W | CTD1062E05A-513 | 07 | 07 |
| 0X | CTD126E02E-513 | 08 | 08 |
| 0Y | CTD160E01F-513 | 09 | 09 |
| 0Z | CTD126E01A-513 | 10 | 10 |
| M81714/62-20-AH | CTJ420E009-7065 | 12 | 12 |
| AL | 012 | 13 | 13 |
| AW | 021 | 14 | 14 |
| AZ | 027 | 15 | 15 |
| BA | 028 | 16 | 16 |
| BG | 034 | 18 | 18 |
| BP | 041 | 19 | 19 |
| CM | 128 | 20 | 20 |
| CN | 129 | 21 | 21 |
| M81714/63-16F | CTJ716K01D-7067 | 25 | 25 |
| 20S | CTJ720E01B-7067 | 30 | 30 |
| 22F | CTJ722K01C-7067 | 40 | 40 |
| 22S | CTJ722E01C-7067 | M81714/69-01 | CTJ-R06 |
| | | 02 | CTJ-R12 |



Компания «Life Electronics» занимается поставками электронных компонентов импортного и отечественного производства от производителей и со складов крупных дистрибьюторов Европы, Америки и Азии.

С конца 2013 года компания активно расширяет линейку поставок компонентов по направлению коаксиальный кабель, кварцевые генераторы и конденсаторы (керамические, пленочные, электролитические), за счёт заключения дистрибьюторских договоров

Мы предлагаем:

- Конкурентоспособные цены и скидки постоянным клиентам.
- Специальные условия для постоянных клиентов.
- Подбор аналогов.
- Поставку компонентов в любых объемах, удовлетворяющих вашим потребностям.
- Приемлемые сроки поставки, возможна ускоренная поставка.
- Доставку товара в любую точку России и стран СНГ.
- Комплексную поставку.
- Работу по проектам и поставку образцов.
- Формирование склада под заказчика.
- Сертификаты соответствия на поставляемую продукцию (по желанию клиента).
- Тестирование поставляемой продукции.
- Поставку компонентов, требующих военную и космическую приемку.
- Входной контроль качества.
- Наличие сертификата ISO.

В составе нашей компании организован Конструкторский отдел, призванный помогать разработчикам, и инженерам.

Конструкторский отдел помогает осуществить:

- Регистрацию проекта у производителя компонентов.
- Техническую поддержку проекта.
- Защиту от снятия компонента с производства.
- Оценку стоимости проекта по компонентам.
- Изготовление тестовой платы монтаж и пусконаладочные работы.



Тел: +7 (812) 336 43 04 (многоканальный)
Email: org@lifeelectronics.ru