

AD8613/AD8617/AD8619

FEATURES

- Offset voltage: 2.2 mV maximum**
- Low input bias current: 1 pA maximum**
- Single-supply operation: 1.8 V to 5 V**
- Low noise: 22 nV/ $\sqrt{\text{Hz}}$**
- Micropower: 50 μA /amplifier maximum over temperature**
- No phase reversal**
- Unity gain stable**
- Qualified for automotive applications**

APPLICATIONS

- Battery-powered instrumentation**
- Multipole filters**
- Current shunt sense**
- Sensors**
- ADC predrivers**
- DAC drivers/level shifters**
- Low power ASIC input or output amplifiers**

GENERAL DESCRIPTION

The AD8613/AD8617/AD8619 are single, dual, and quad micro-power, rail-to-rail input and output amplifiers that feature low supply current, as well as low input voltage and current noise.

The parts are fully specified to operate from 1.8 V to 5 V single supply, or ± 0.9 V and ± 2.5 V dual supply. The combination of low noise, very low input bias currents, and low power consumption make the AD8613/AD8617/AD8619 especially useful in portable and loop-powered instrumentation.

The ability to swing rail-to-rail at both the input and output enables designers to buffer CMOS ADCs, DACs, ASICs, and other wide output swing devices in low power, single-supply systems.

The AD8613 is available in a 5-lead SC70 package and a 5-lead TSOT-23 package. The AD8617 is available in 8-lead MSOP, 8-lead SOIC, and 8-lead LFCSP packages. The AD8619 is available in 14-lead TSSOP and 14-lead SOIC packages. The AD8617W is qualified for automotive applications and is available in an 8-lead MSOP package and an 8-lead SOIC package.

PIN CONFIGURATIONS

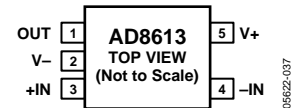

Figure 1. 5-Lead SC70 and 5-Lead TSOT-23

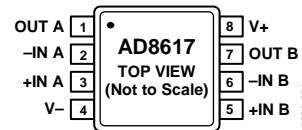
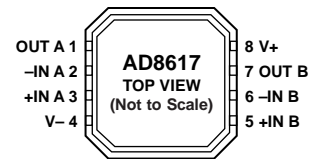

Figure 2. 8-Lead MSOP and 8-Lead SOIC_N



NOTES

1. PIN 4 AND THE EXPOSED PAD MUST BE CONNECTED TO V-.

Figure 3. 8-Lead LFCSP_VD

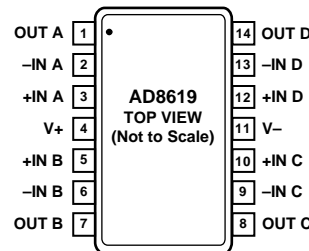

Figure 4. 14-Lead TSSOP

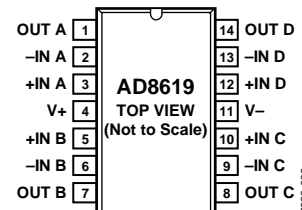

Figure 5. 14-Lead SOIC_N

Rev. E

Information furnished by Analog Devices is believed to be accurate and reliable. However, no responsibility is assumed by Analog Devices for its use, nor for any infringements of patents or other rights of third parties that may result from its use. Specifications subject to change without notice. No license is granted by implication or otherwise under any patent or patent rights of Analog Devices. Trademarks and registered trademarks are the property of their respective owners.

TABLE OF CONTENTS

Features	1	Thermal Resistance	5
Applications.....	1	ESD Caution.....	5
General Description	1	Typical Performance Characteristics	6
Pin Configurations	1	Outline Dimensions	12
Revision History	2	Ordering Guide	15
Specifications.....	3		
Absolute Maximum Ratings.....	5		

REVISION HISTORY

3/10—Rev. D to Rev. E

Changes to General Description	1
Changes to Ordering Guide	15

3/10—Rev. C to Rev. D

Changes to General Description	1
Changes to Ordering Guide	15

10/09—Rev. B to Rev. C

Added 8-Lead LFCSP Package.....	Universal
Changes to Features Section, Figure 2 Caption, General Description Section, and Figure 3	1
Changed V_S to V_{SY} Throughout.....	3
Changes to Input Characteristics, Input Voltage Range Parameter; Dynamic Performance, Settling Time to 0.1% and Phase Margin Parameters; and Noise Performance, Peak-to-Peak Noise Parameter, Table 1	3
Changes to Input Characteristics, Input Voltage Range Parameter; Dynamic Performance, Settling Time to 0.1% and Phase Margin Parameters; and Noise Performance, Peak-to-Peak Noise Parameter, Table 2	4
Changes to Table 3 and Table 4.....	5
Changes to Figure 12 to Figure 15.....	7
Changes to Figure 18 Caption.....	8
Changes to Figure 30 and Figure 31.....	10
Updated Outline Dimensions	12
Added Figure 44; Renumbered Sequentially	14
Changes to Ordering Guide	15

1/06—Rev. A to Rev. B

Added AD8613	Universal
Changes to Features	1
Changes to Table 1.....	3
Changes to Table 2.....	4
Updated Outline Dimensions	12
Changes to Ordering Guide	13

10/05—Rev. 0 to Rev. A

Added AD8619	Universal
Change to Specifications Section	3
Updated Outline Dimensions	12
Changes to Ordering Guide	13

9/05—Revision 0: Initial Version

SPECIFICATIONS

Electrical characteristics at $V_{SY} = 5\text{ V}$, $V_{CM} = V_{SY}/2$, $T_A = 25^\circ\text{C}$, unless otherwise noted.

Table 1.

Parameter	Symbol	Conditions	Min	Typ	Max	Unit
INPUT CHARACTERISTICS						
Offset Voltage	V_{OS}	$-0.3\text{ V} < V_{CM} < +5.3\text{ V}$ $-40^\circ\text{C} < T_A < +125^\circ\text{C}$, $-0.3\text{ V} < V_{CM} < +5.2\text{ V}$		0.4	2.2	mV
Offset Voltage Drift	$\Delta V_{OS}/\Delta T$	$-40^\circ\text{C} < T_A < +125^\circ\text{C}$		1	2.2	mV
AD8613				2.5	4.5	$\mu\text{V}/^\circ\text{C}$
Input Bias Current	I_B	$-40^\circ\text{C} < T_A < +125^\circ\text{C}$		0.2	1	$\mu\text{V}/^\circ\text{C}$
		$-40^\circ\text{C} < T_A < +85^\circ\text{C}$			110	pA
		$-40^\circ\text{C} < T_A < +125^\circ\text{C}$			780	pA
Input Offset Current	I_{OS}	$-40^\circ\text{C} < T_A < +85^\circ\text{C}$		0.1	0.5	pA
		$-40^\circ\text{C} < T_A < +125^\circ\text{C}$			50	pA
		$-40^\circ\text{C} < T_A < +125^\circ\text{C}$			250	pA
Input Voltage Range	IVR		0		5	V
Common-Mode Rejection Ratio	CMRR	$0\text{ V} < V_{CM} < 5\text{ V}$ $-40^\circ\text{C} < T_A < +125^\circ\text{C}$		95		dB
Large Signal Voltage Gain	A_{VO}	$R_L = 10\text{ k}\Omega$, $0.5\text{ V} < V_O < 4.5\text{ V}$	68			dB
Input Capacitance	C_{DIFF}			1.9		pF
	C_{CM}			2.5		pF
OUTPUT CHARACTERISTICS						
Output Voltage High	V_{OH}	$I_L = 1\text{ mA}$ -40°C to $+125^\circ\text{C}$	4.95	4.98		V
		$I_L = 10\text{ mA}$ -40°C to $+125^\circ\text{C}$	4.9			V
Output Voltage Low	V_{OL}	$I_L = 1\text{ mA}$ -40°C to $+125^\circ\text{C}$	4.50			V
		$I_L = 10\text{ mA}$ -40°C to $+125^\circ\text{C}$		20	30	mV
		$I_L = 10\text{ mA}$ -40°C to $+125^\circ\text{C}$			50	mV
		$I_L = 10\text{ mA}$ -40°C to $+125^\circ\text{C}$		190	275	mV
		-40°C to $+125^\circ\text{C}$			335	mV
Short-Circuit Current	I_{SC}			± 80		mA
Closed-Loop Output Impedance	Z_{OUT}	$f = 10\text{ kHz}$, $A_V = 1$		15		Ω
POWER SUPPLY						
Power Supply Rejection Ratio	PSRR	$1.8\text{ V} < V_{SY} < 5\text{ V}$ $-40^\circ\text{C} < T_A < +125^\circ\text{C}$	67	94		dB
			64			dB
Supply Current/Amplifier	I_{SY}	$V_O = V_{SY}/2$ $-40^\circ\text{C} < T_A < +125^\circ\text{C}$		38		μA
					50	μA
DYNAMIC PERFORMANCE						
Slew Rate	SR	$R_L = 10\text{ k}\Omega$		0.1		$\text{V}/\mu\text{s}$
Settling Time to 0.1%	t_s	$G = \pm 1$, $V_{IN} = 2\text{ V}$ step, $C_L = 20\text{ pF}$, $R_L = 1\text{ k}\Omega$		23		μs
Gain Bandwidth Product	GBP	$R_L = 100\text{ k}\Omega$		400		kHz
		$R_L = 10\text{ k}\Omega$		350		kHz
Phase Margin	ϕ_M	$R_L = 10\text{ k}\Omega$, $R_L = 100\text{ k}\Omega$, $C_L = 20\text{ pF}$		70		Degrees
NOISE PERFORMANCE						
Peak-to-Peak Noise	e_n p-p	0.1 Hz to 10 Hz		2.3	3.5	μV
Voltage Noise Density	e_n	$f = 1\text{ kHz}$		25		$\text{nV}/\sqrt{\text{Hz}}$
		$f = 10\text{ kHz}$		22		$\text{nV}/\sqrt{\text{Hz}}$
Current Noise Density	i_n	$f = 1\text{ kHz}$		0.05		$\text{pA}/\sqrt{\text{Hz}}$

AD8613/AD8617/AD8619

Electrical characteristics at $V_{SY} = 1.8\text{ V}$, $V_{CM} = V_{SY}/2$, $T_A = 25^\circ\text{C}$, unless otherwise noted.

Table 2.

Parameter	Symbol	Conditions	Min	Typ	Max	Unit
INPUT CHARACTERISTICS						
Offset Voltage	V_{OS}	$-0.3\text{ V} < V_{CM} < +1.9\text{ V}$ $-0.3\text{ V} < V_{CM} < +1.8\text{ V}; -40^\circ\text{C} < T_A < +125^\circ\text{C}$		0.4	2.2	mV
Offset Voltage Drift	$\Delta V_{OS}/\Delta T$	$-40^\circ\text{C} < T_A < +125^\circ\text{C}$		1	8.5	$\mu\text{V}/^\circ\text{C}$
AD8613				3.7	9.0	$\mu\text{V}/^\circ\text{C}$
Input Bias Current	I_B	$-40^\circ\text{C} < T_A < +85^\circ\text{C}$ $-40^\circ\text{C} < T_A < +125^\circ\text{C}$		0.2	1	pA
					110	pA
Input Offset Current	I_{OS}	$-40^\circ\text{C} < T_A < +85^\circ\text{C}$ $-40^\circ\text{C} < T_A < +125^\circ\text{C}$		0.1	0.5	pA
					50	pA
Input Voltage Range	IVR		0		1.8	V
Common-Mode Rejection Ratio	CMRR	$0\text{ V} < V_{CM} < 1.8\text{ V}$ $-40^\circ\text{C} < T_A < +125^\circ\text{C}$	58	86		dB
			55			dB
Large Signal Voltage Gain	A_{VO}	$R_L = 10\text{ k}\Omega$, $0.5\text{ V} < V_O < 1.3\text{ V}$	85	1000		V/mV
Input Capacitance	C_{DIFF} C_{CM}			2.1		pF
				3.8		pF
OUTPUT CHARACTERISTICS						
Output Voltage High	V_{OH}	$I_L = 1\text{ mA}$ -40°C to $+125^\circ\text{C}$	1.65	1.73		V
			1.6			V
Output Voltage Low	V_{OL}	$I_L = 1\text{ mA}$ -40°C to $+125^\circ\text{C}$		44	60	mV
					80	mV
Short-Circuit Current	I_{SC}			± 7		mA
Closed-Loop Output Impedance	Z_{OUT}	$f = 10\text{ kHz}$, $A_V = 1$		15		Ω
POWER SUPPLY						
Power Supply Rejection Ratio	PSRR	$1.8\text{ V} < V_S < 5\text{ V}$	67	94		dB
Supply Current/Amplifier	I_{SY}	$V_O = V_{SY}/2$ $-40^\circ\text{C} < T_A < +125^\circ\text{C}$		38	50	μA
						μA
DYNAMIC PERFORMANCE						
Slew Rate	SR	$R_L = 10\text{ k}\Omega$		0.1		V/ μs
Settling Time to 0.1%	t_S	$G = \pm 1$, $V_{IN} = 1\text{ V}$ step, $C_L = 20\text{ pF}$, $R_L = 1\text{ k}\Omega$		6.5		μs
Gain Bandwidth Product	GBP	$R_L = 100\text{ k}\Omega$ $R_L = 10\text{ k}\Omega$		400		kHz
				350		kHz
Phase Margin	ϕ_M	$R_L = 10\text{ k}\Omega$, $R_L = 100\text{ k}\Omega$, $C_L = 20\text{ pF}$		70		Degrees
NOISE PERFORMANCE						
Peak-to-Peak Noise	e_n p-p	0.1 Hz to 10 Hz		2.3	3.5	μV
Voltage Noise Density	e_n	$f = 1\text{ kHz}$ $f = 10\text{ kHz}$		25		$\text{nV}/\sqrt{\text{Hz}}$
				22		$\text{nV}/\sqrt{\text{Hz}}$
Current Noise Density	i_n	$f = 1\text{ kHz}$		0.05		$\text{pA}/\sqrt{\text{Hz}}$

ABSOLUTE MAXIMUM RATINGS

$T_A = 25^\circ\text{C}$, unless otherwise noted.

Table 3.

Parameter	Rating
Supply Voltage	6 V
Input Voltage	$V_{SS} - 0.3\text{ V}$ to $V_{DD} + 0.3\text{ V}$
Input Current	$\pm 10\text{ mA}$
Differential Input Voltage	$\pm 6\text{ V}$
Output Short-Circuit Duration to GND	Indefinite
Storage Temperature Range	-65°C to $+150^\circ\text{C}$
Lead Temperature (Soldering, 60 sec)	300°C
Operating Temperature Range	-40°C to $+125^\circ\text{C}$
Junction Temperature Range	-65°C to $+150^\circ\text{C}$

Stresses above those listed under Absolute Maximum Ratings may cause permanent damage to the device. This is a stress rating only; functional operation of the device at these or any other conditions above those indicated in the operational section of this specification is not implied. Exposure to absolute maximum rating conditions for extended periods may affect device reliability.

THERMAL RESISTANCE

θ_{JA} is specified for the worst-case conditions, that is, a device soldered in a circuit board for surface-mount packages.

Table 4. Thermal Characteristics

Package Type	θ_{JA}	θ_{JC}	Unit
5-Lead TSOT-23 (UJ-5)	207	61	$^\circ\text{C}/\text{W}$
5-Lead SC70 (KS-5)	376	126	$^\circ\text{C}/\text{W}$
8-Lead MSOP (RM-8)	210	45	$^\circ\text{C}/\text{W}$
8-Lead SOIC_N (R-8)	158	43	$^\circ\text{C}/\text{W}$
8-Lead LFCSP_VD (CP-8-9)	81	20	$^\circ\text{C}/\text{W}$
14-Lead SOIC_N (R-14)	120	36	$^\circ\text{C}/\text{W}$
14-Lead TSSOP (RU-14)	180	35	$^\circ\text{C}/\text{W}$

ESD CAUTION



ESD (electrostatic discharge) sensitive device. Charged devices and circuit boards can discharge without detection. Although this product features patented or proprietary protection circuitry, damage may occur on devices subjected to high energy ESD. Therefore, proper ESD precautions should be taken to avoid performance degradation or loss of functionality.

TYPICAL PERFORMANCE CHARACTERISTICS

$V_{SY} = 5\text{ V}$ or $\pm 2.5\text{ V}$, unless otherwise noted.



Figure 6. Input Offset Voltage Distribution

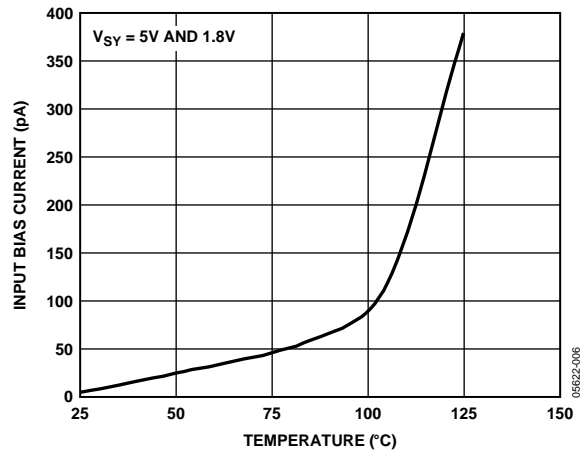

Figure 9. Input Bias Current vs. Temperature



Figure 7. Input Offset Voltage Drift Distribution

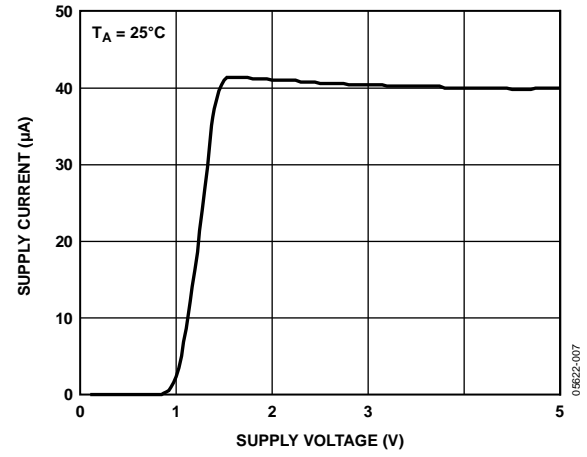

Figure 10. Supply Current vs. Supply Voltage



Figure 8. Input Offset Voltage vs. Input Common-Mode Voltage

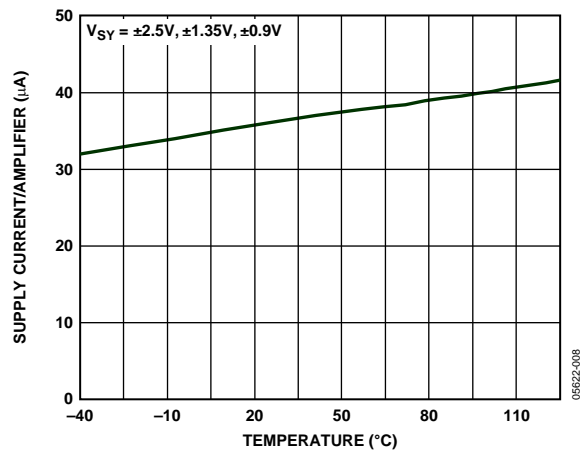

Figure 11. Supply Current vs. Temperature



Figure 12. Output Voltage to Supply Rail vs. Load Current



Figure 15. Open-Loop Gain and Phase vs. Frequency



Figure 13. Output Voltage to Supply Rail vs. Temperature ($I_L = 1 \text{ mA}$)

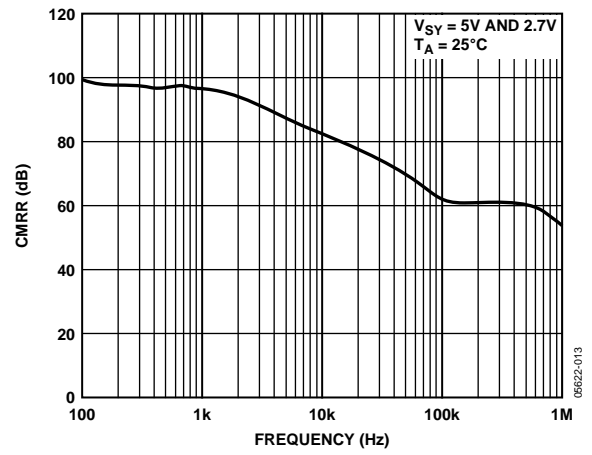

Figure 16. CMRR vs. Frequency



Figure 14. Output Voltage to Supply Rail vs. Temperature ($I_L = 10 \text{ mA}$)

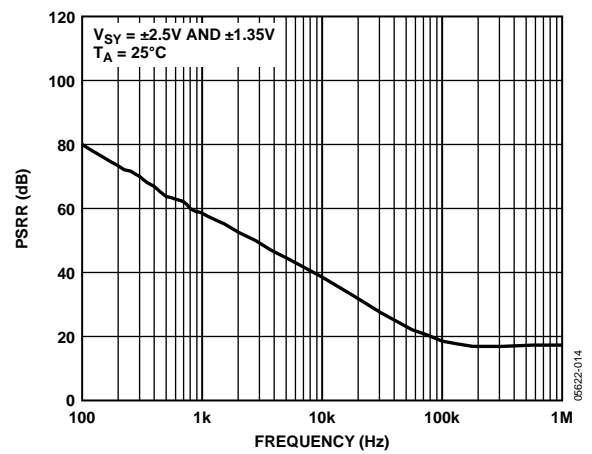

Figure 17. PSRR vs. Frequency



Figure 18. Output Impedance vs. Frequency



Figure 21. Large Signal Transient Response



Figure 19. Small Signal Overshoot vs. Load Capacitance



Figure 22. Positive Overload Recovery



Figure 20. Small Signal Transient Response



Figure 23. Negative Overload Recovery



Figure 24. No Phase Reversal



Figure 26. Voltage Noise Density



Figure 25. 0.1 Hz to 10 Hz Input Voltage Noise

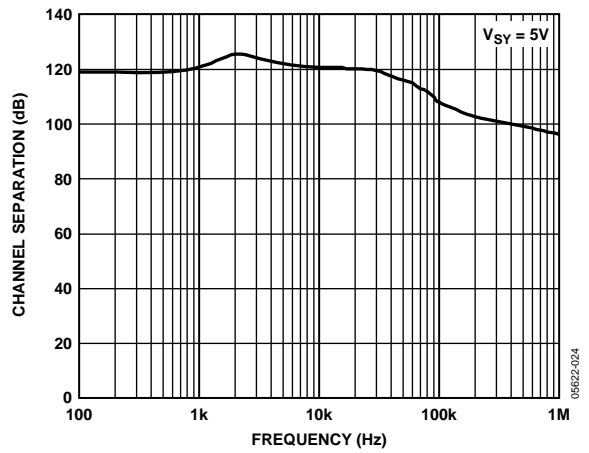

Figure 27. Channel Separation

AD8613/AD8617/AD8619

$V_{SY} = 1.8\text{ V}$ or $\pm 0.9\text{ V}$, unless otherwise noted.



Figure 28. Input Offset Voltage Distribution



Figure 31. Output Voltage to Supply Rail vs. Temperature ($I_L = 1\text{ mA}$)



Figure 29. Input Offset Voltage vs. Input Common-Mode Voltage



Figure 32. CMRR vs. Frequency



Figure 30. Output Voltage to Supply Rail vs. Load Current



Figure 33. PSRR vs. Frequency



Figure 34. Small Signal Overshoot vs. Load Capacitance



Figure 36. 0.1 Hz to 10 Hz Input Voltage Noise



Figure 35. Large Signal Transient Response



Figure 37. Voltage Noise Density

OUTLINE DIMENSIONS



COMPLIANT TO JEDEC STANDARDS MO-187-AA

Figure 38. 8-Lead Mini Small Outline Package [MSOP] (RM-8)

Dimensions shown in millimeters

100709-B

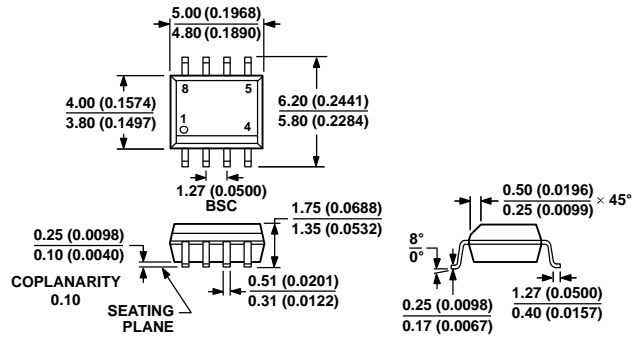

COMPLIANT TO JEDEC STANDARDS MS-012-AA
CONTROLLING DIMENSIONS ARE IN MILLIMETERS; INCH DIMENSIONS (IN PARENTHESES) ARE ROUNDED-OFF MILLIMETER EQUIVALENTS FOR REFERENCE ONLY AND ARE NOT APPROPRIATE FOR USE IN DESIGN.

Figure 39. 8-Lead Standard Small Outline Package [SOIC_N] Narrow Body (R-8)

Dimensions shown in millimeters and (inches)

012407-A



COMPLIANT TO JEDEC STANDARDS MS-012-AB
CONTROLLING DIMENSIONS ARE IN MILLIMETERS; INCH DIMENSIONS (IN PARENTHESES) ARE ROUNDED-OFF MILLIMETER EQUIVALENTS FOR REFERENCE ONLY AND ARE NOT APPROPRIATE FOR USE IN DESIGN.

Figure 40. 14-Lead Standard Small Outline Package [SOIC_N] Narrow Body (R-14)

Dimensions shown in millimeters and (inches)

060606-A



COMPLIANT TO JEDEC STANDARDS MO-153-AB-1

Figure 41. 14-Lead Thin Shrink Small Outline Package [TSSOP] (RU-14)

Dimensions shown in millimeters

061908-A

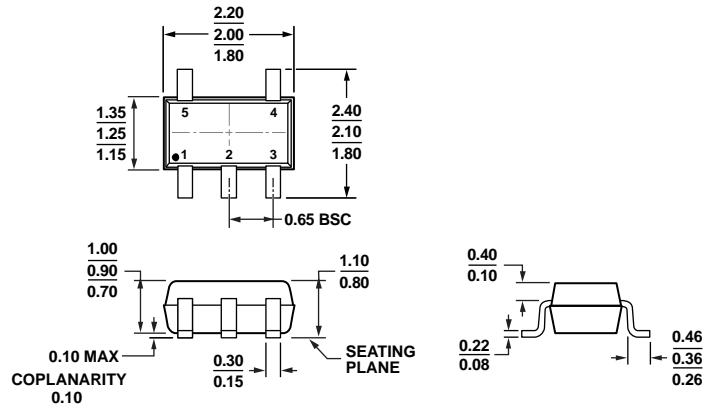

COMPLIANT TO JEDEC STANDARDS MO-203-AA

Figure 42. 5-Lead Thin Shrink Small Outline Transistor Package [SC70] (KS-5)

Dimensions shown in millimeters

072809-A

AD8613/AD8617/AD8619

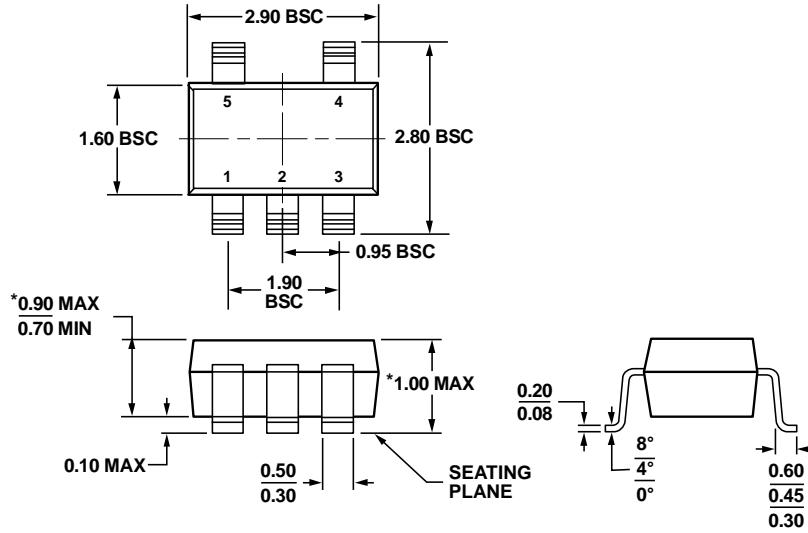

*COMPLIANT TO JEDEC STANDARDS MO-193-AB WITH THE EXCEPTION OF PACKAGE HEIGHT AND THICKNESS.

Figure 43. 5-Lead Thin Small Outline Transistor Package [TSOT-23] (UJ-5)

Dimensions shown in millimeters

100708-A

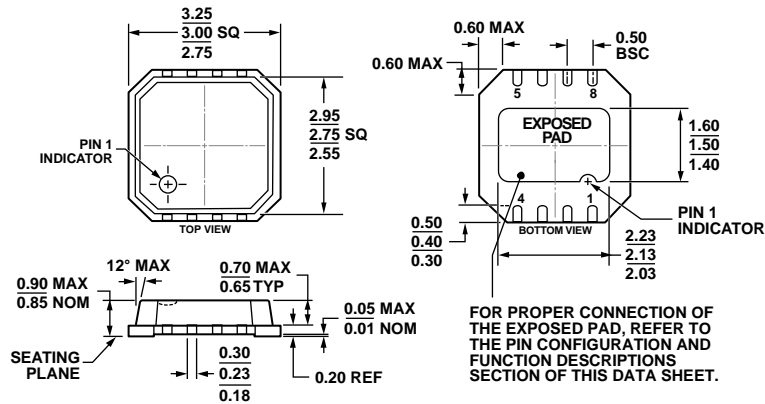

Figure 44. 8-Lead Lead Frame Chip Scale Package [LFCSP_VD]

3 mm × 3 mm Body, Very Thin, Dual Lead (CP-8-9)

Dimensions shown in millimeters

FOR PROPER CONNECTION OF THE EXPOSED PAD, REFER TO THE PIN CONFIGURATION AND FUNCTION DESCRIPTIONS SECTION OF THIS DATA SHEET.

0519809-A

ORDERING GUIDE

Model ¹	Temperature Range	Package Description	Package Option	Branding
AD8613AKSZ-R2	-40°C to +125°C	5-Lead SC70	KS-5	A0Y
AD8613AKSZ-REEL	-40°C to +125°C	5-Lead SC70	KS-5	A0Y
AD8613AKSZ-REEL7	-40°C to +125°C	5-Lead SC70	KS-5	A0Y
AD8613AUJZ-R2	-40°C to +125°C	5-Lead TSOT-23	UJ-5	A0Y
AD8613AUJZ-REEL	-40°C to +125°C	5-Lead TSOT-23	UJ-5	A0Y
AD8613AUJZ-REEL7	-40°C to +125°C	5-Lead TSOT-23	UJ-5	A0Y
AD8617ACPZ-R2	-40°C to +125°C	8-Lead LFCSP_VD	CP-8-9	A0T
AD8617ACPZ-R7	-40°C to +125°C	8-Lead LFCSP_VD	CP-8-9	A0T
AD8617ACPZ-RL	-40°C to +125°C	8-Lead LFCSP_VD	CP-8-9	A0T
AD8617ARMZ	-40°C to +125°C	8-Lead MSOP	RM-8	A0T
AD8617ARMZ-REEL	-40°C to +125°C	8-Lead MSOP	RM-8	A0T
AD8617ARZ	-40°C to +125°C	8-Lead SOIC_N	R-8	
AD8617ARZ-REEL	-40°C to +125°C	8-Lead SOIC_N	R-8	
AD8617ARZ-REEL7	-40°C to +125°C	8-Lead SOIC_N	R-8	
AD8617WARMZ-REEL ²	-40°C to +125°C	8-Lead MSOP	RM-8	A23
AD8617WARZ-R7 ²	-40°C to +125°C	8-Lead SOIC_N	R-8	
AD8617WARZ-RL ²	-40°C to +125°C	8-Lead SOIC_N	R-8	
AD8619ARUZ	-40°C to +125°C	14-Lead TSSOP	RU-14	
AD8619ARUZ-REEL	-40°C to +125°C	14-Lead TSSOP	RU-14	
AD8619ARZ	-40°C to +125°C	14-Lead SOIC_N	R-14	
AD8619ARZ-REEL	-40°C to +125°C	14-Lead SOIC_N	R-14	
AD8619ARZ-REEL7	-40°C to +125°C	14-Lead SOIC_N	R-14	

¹ Z = RoHS Compliant Part.² Qualified for automotive applications.

NOTES

Компания «Life Electronics» занимается поставками электронных компонентов импортного и отечественного производства от производителей и со складов крупных дистрибьюторов Европы, Америки и Азии.

С конца 2013 года компания активно расширяет линейку поставок компонентов по направлению коаксиальный кабель, кварцевые генераторы и конденсаторы (керамические, пленочные, электролитические), за счёт заключения дистрибьюторских договоров

Мы предлагаем:

- Конкурентоспособные цены и скидки постоянным клиентам.
- Специальные условия для постоянных клиентов.
- Подбор аналогов.
- Поставку компонентов в любых объемах, удовлетворяющих вашим потребностям.
- Приемлемые сроки поставки, возможна ускоренная поставка.
- Доставку товара в любую точку России и стран СНГ.
- Комплексную поставку.
- Работу по проектам и поставку образцов.
- Формирование склада под заказчика.
- Сертификаты соответствия на поставляемую продукцию (по желанию клиента).
- Тестирование поставляемой продукции.
- Поставку компонентов, требующих военную и космическую приемку.
- Входной контроль качества.
- Наличие сертификата ISO.

В составе нашей компании организован Конструкторский отдел, призванный помогать разработчикам, и инженерам.

Конструкторский отдел помогает осуществить:

- Регистрацию проекта у производителя компонентов.
- Техническую поддержку проекта.
- Защиту от снятия компонента с производства.
- Оценку стоимости проекта по компонентам.
- Изготовление тестовой платы монтаж и пусконаладочные работы.



Тел: +7 (812) 336 43 04 (многоканальный)

Email: org@lifeelectronics.ru