

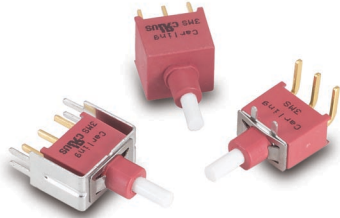

**3MN-Series**  
**Snap-Action** Miniature Pushbutton Switch

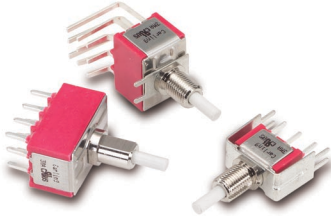

**3MS-Series**  
**Sealed Snap-Action** Miniature Pushbutton Switch



**3MA-Series**  
**Alternate Action** Miniature Pushbutton Switch

### Specifications

Contact Rating . . . . .	refer to ordering scheme
Electrical Life . . . . .	50,000 make & break cycles @ full load
Contact Resistance. . . . .	<b>3MN &amp; 3MA-Series:</b> 10 mΩ max. initial @ 2-4 VDC 100mA for both silver & gold plated contacts. <b>3MS-Series:</b> 50 mΩ max. initial @ 2-4 VDC 100mA for both silver & gold plated contacts.
Insulation Resistance . . .	1000 MΩ min.
Dielectric Strength . . . . .	1500 Volts RMS @ sea level
Operating Temperature . . .	-30°C to +85°C
Index of Protection . . . . .	<b>3MS -Series:</b> IP68
Cap Installation Support . .	<b>3MS-Series:</b> 10 lbs. max.
Solder Heat Resistance. . .	MIL-STD-202, Method 210
Actuator Travel . . . . .	.25°

### Materials

Case . . . . .	<b>3MN &amp; 3MA-Series:</b> Diallyl phthalate (DAP) (UL 94V-0) <b>3MS-Series:</b> Glass filled nylon 6/6, flame retardant, heat stabilized (UL 94V-0)
Plunger. . . . .	<b>3MN-Series:</b> Thermoplastic polyester, black <b>3MS &amp; 3MA-Series:</b> Glass filled nylon or glass filled polyester (UL 94V-0)
Bushing . . . . .	<b>3MN-Series:</b> Brass, nickel plated <b>3MA-Series:</b> Zinc, nickel plated
Housing. . . . .	<b>3MN &amp; 3MA-Series:</b> Stainless Steel
Switch Support Retainer . .	<b>3MS-Series:</b> Stainless Steel
Terminal Seal . . . . .	Epoxy

### 3M-Series Optional Cap

To order a cap assembled on a switch, specify the switch number followed by the cap part number and the word "assembled".

Ex: 3MN-SP-7-P2-B6-M6QE-C13ASSEMBLED

To order caps in bulk, specify the Series, followed by the cap. Ex.) 3MN-C13



<p><b>1 SERIES OR SWITCH CATALOG NUMBER</b> 3MN, 3MS or 3MA</p>	<p><b>3 CAP COLOR</b></p> <table border="0" style="width: 100%;"> <tr> <td>1 white</td> <td>5 yellow</td> </tr> <tr> <td>2 black</td> <td>6 green</td> </tr> <tr> <td>3 red</td> <td>7 blue</td> </tr> <tr> <td>4 orange</td> <td></td> </tr> </table> <p><small>1 Black, white &amp; red standard. Other colors available. Consult factory.</small></p>	1 white	5 yellow	2 black	6 green	3 red	7 blue	4 orange	
1 white	5 yellow								
2 black	6 green								
3 red	7 blue								
4 orange									
<p><b>2 CAP SIZE</b></p> <table border="0" style="width: 100%;"> <tr> <td><b>C1</b> round 7.6mm dia.</td> <td><b>C5</b> round 14.5mm dia. (for 3MA w/ PL bushing)</td> </tr> <tr> <td><b>C2</b> round 9.35 mm dia.</td> <td><b>C6</b> brass chrome plated (for 3MA w/ PD bushing)</td> </tr> <tr> <td><b>C3</b> square 11.7 x 11.7mm</td> <td></td> </tr> <tr> <td><b>C4</b> round 5mm dia.</td> <td></td> </tr> </table>	<b>C1</b> round 7.6mm dia.	<b>C5</b> round 14.5mm dia. (for 3MA w/ PL bushing)	<b>C2</b> round 9.35 mm dia.	<b>C6</b> brass chrome plated (for 3MA w/ PD bushing)	<b>C3</b> square 11.7 x 11.7mm		<b>C4</b> round 5mm dia.		
<b>C1</b> round 7.6mm dia.	<b>C5</b> round 14.5mm dia. (for 3MA w/ PL bushing)								
<b>C2</b> round 9.35 mm dia.	<b>C6</b> brass chrome plated (for 3MA w/ PD bushing)								
<b>C3</b> square 11.7 x 11.7mm									
<b>C4</b> round 5mm dia.									

**3MN-Series Ordering Scheme**
**with Square Actuator**

**with Plunger Actuator**

**1 SERIES**
**3MN** Snap-Action Miniature Pushbutton Switch

**2 POLES**
**SP** single pole **DP** double pole
**3 CIRCUIT**

( ) - momentary

**7**      ON                                (ON)

**4 ACTUATOR<sup>1</sup>**
**SQUARE ACTUATOR** *(use with Color Options in Selection 5A & 5B.)*
**AP1** square with no frame  
**AP2** square raised above frame  
**AP3** square flush with frame

**PLUNGER ACTUATOR** *(use with Bushing Options in Selection 5)*
**P0** 2.5mm short plunger(for B6 bushing only)  
**P1** 5.2mm plunger(for bushing B10,B11,B20,B21; 7.5mm for B6)  
**P2** 2.0mm plunger(for bushing B10,B11,B20,B21; 4.2mm for B6)

**5A ACTUATOR COLOR & 5B FRAME COLOR<sup>1,2</sup>**

1 white	4 orange	7 blue
2 black	5 yellow	8 brown
3 red	6 green	9 gray

1 Black, white and red are standard. Other colors available, consult factory for details.  
 2 Selection 5B is blank if actuator style is AP1 (no frame)

**OR**
**5 BUSHING**
**B6** Unthreaded (for terminations VS6-VS9 only)  
**B10** Threaded keyway  
**B11** Threaded with flat  
**B20** Unthreaded keyway  
**B21** Unthreaded with flat

**NOTE:**

 If ordering optional CAP with bushings B10, B11, B20 or B21, specify actuator P1.  
 For CAP with bushing B6, specify actuator P2.  
 For CAP options, see ordering scheme on page 35.

**6 TERMINATION**

<b>M1</b>	Solder Lug
<b>M2</b>	PCB
<b>M5-1</b>	Wire Wrap .750 [19.05]
<b>M5-3</b>	Wire Wrap .425 [10.80]
<b>M6</b>	PC Mount, 90° horizontal
<b>M7</b>	PC Mount, 90° vertical
<b>VS2</b>	PC Mount, U bracket, .620 mounting x .460 high
<b>VS3</b>	PC Mount, U bracket, .620 mounting x .630 high
<b>VS4</b>	PC Mount, U bracket, .750 mounting x .460 high
<b>VS5</b>	PC Mount, U bracket, .750 mounting x .630 high
<b>VS6</b>	PC Mount, U bracket, .460 high (for B6 bushing only)
<b>VS7</b>	PC Mount, U bracket, .630 high (for B6 bushing only)
<b>VS8</b>	PC Mount, U bracket, .460 high (for B6 bushing only)
<b>VS9</b>	PC Mount, U bracket, .630 high (for B6 bushing only)

**7 CONTACT**

	Material	Terminal Plating	Rating	Approvals
<b>G</b>	silver <sup>1</sup>	gold over silver <sup>3</sup>	1A@120VAC or 28VDC	UL, CUL
<b>Q</b>	silver <sup>1</sup>	silver <sup>1</sup>	1A@120VAC or 28VDC	UL, CUL
<b>R</b>	gold <sup>2</sup>	gold <sup>2</sup>	0.4VA max. @20V max (AC/DC)	

**NOTE:**

Tin-lead option available with PC type terminations only.  
 1 Moveable contact & terminals: copper alloy, silver plate  
 2 Moveable contact & terminals: copper alloy with gold plate over nickel plate  
 3 Terminals: silver plate with outer layer in gold plating

**8 EPOXY SEAL**
**E** epoxy seal

### 3MS-Series Ordering Scheme

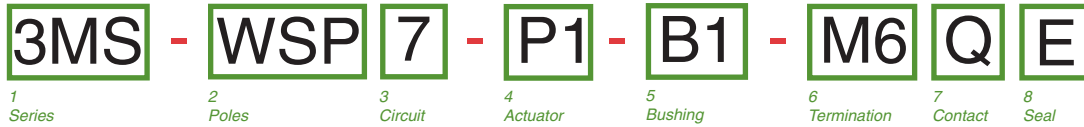
**1 SERIES**
**3MS** Sealed Snap-Action Miniature Pushbutton Switch

**2 POLES**
**WSP** single pole

**WDP** double pole

**3 CIRCUIT**

( ) - momentary

**7** ON (ON)

**4 ACTUATOR**
**P1** .173" plunger (for B1 bushing); .276" (for B4 bushing)  
**P2** .220" plunger (for B1 bushing); .327" (for B4 bushing)  
**P3** .087" plunger (for B1 bushing); .193" (for B4 bushing)

**5 BUSHING**
**B1** Threaded  
**B4** Unthreaded

**6 TERMINATION**
**M1** Solder Lug

**M2** PCB

**M6** PC Mount, 90° horizontal

**M61** Snap-In, 90° horizontal

**M7** PC Mount, 90° vertical

**M71** Snap-In, 90° vertical

**VS2** PC Mount, U bracket, .620 mounting x .460 high

**VS21** Snap-In, U bracket, .620 mounting x .460 high

**VS3** PC Mount, U bracket, .620 mounting x .630 high

**VS4** PC Mount, U bracket, .750 mounting x .460 high

**VS5** PC Mount, U bracket, .750 mounting x .630 high

**7 CONTACT**

G	Material	Terminal Plating	Rating	Approvals
<b>Q</b>	silver <sup>1</sup>	gold over silver <sup>3</sup>	1A@120VAC or 28VDC	UL, CUL IP68
<b>R</b>	gold <sup>2</sup>	gold <sup>2</sup>	1A@120VAC or 28VDC 0.4VA max. @20V max (AC/DC)	UL, CUL IP68

**NOTE:**

Tin-lead option available with PC type terminations only.

1 Moveable contact &amp; terminals: copper alloy, silver plate

2 Moveable contact &amp; terminals: copper alloy with gold plate over nickel plate

3 Terminals: silver plate with outer layer in gold plating

**7 EPOXY SEAL**
**E** epoxy seal

### 3MA-Series Ordering Scheme

with Square Actuator



with Plunger Actuator

**1 SERIES**
**3MA** Alternate-Action Miniature Pushbutton Switch

**2 POLES**
**SP** single pole

**DP** double pole

**3P** three pole

**4P** four pole

**3 CIRCUIT**

( ) - momentary

**Switching Position:**

1	ON	2-3, 5-6, 8-9, 11-12	OPEN	2-1, 5-4, 8-7, 11-10
2	ON		NONE	ON (ON)

**4 ACTUATOR**
**SQUARE ACTUATOR** (use with Color Options in Selection 5A & 5B.)

**AP1** square with no frame

**AP2** square raised above frame

**PLUNGER ACTUATOR** (use with Bushing Options in Selection 5)

**PA** .118 dia. x .299" plunger length

**PI** .118 dia. x .244" plunger length

**PL** .118 dia. x .327" plunger length

**PC** .315" dia. brass chrome plated plunger (for BD bushing only)

**PD** .242" dia. brass chrome plated plunger (for BD bushing only)

**6 TERMINATION**
**M1** Solder Lug

**M2** PCB

**M5-1** Wire Wrap .750 [19.05]

**M5-2** Wire Wrap .964 [24.48]

**M5-3** Wire Wrap .425 [10.80]

**M5-4** Wire Wrap 1.062 [26.87]

**M6** PC Mount, 90° horizontal

**M7** PC Mount, 90° vertical

**VS2** PC Mount, U bracket, .620 mounting x .460 high

**VS3** PC Mount, U bracket, .620 mounting x .630 high

**VS4** PC Mount, U bracket, .750 mounting x .460 high

**VS5** PC Mount, U bracket, .750 mounting x .630 high

**7 CONTACT**

G	Material	Terminal Plating	Rating	Approvals
<b>K</b>	gold <sup>2</sup>	tin-lead <sup>4</sup>	6A@125VAC or 28VDC, 3A@250VAC	
<b>P</b>	silver <sup>1</sup>	tin-lead <sup>4</sup>	6A@125VAC or 28VDC, 3A@250VAC	UL, CUL
<b>Q</b>	silver <sup>1</sup>	silver <sup>1</sup>	6A@125VAC or 28VDC, 3A@250VAC	UL, CUL
<b>R</b>	gold <sup>2</sup>	gold <sup>2</sup>	0.4VA max. @20V max (AC/DC)	

**NOTE:**

Tin-lead option available with PC type terminations only.

1 Moveable contact &amp; terminals: copper alloy, silver plate

2 Moveable contact &amp; terminals: copper alloy with gold plate over nickel plate

3 Terminals: silver plate with outer layer in gold plating

4 Outer terminals: copper alloy with tin-lead over nickel plate

**8 EPOXY SEAL**
**E** epoxy seal

**5A ACTUATOR COLOR & 5B FRAME COLOR<sup>1,2</sup>**

1 white	4 orange	7 blue
2 black	5 yellow	8 brown
3 red	6 green	9 gray

1 Black, red and white are standard. Other colors available, consult factory for details.

2 Selection 5B is blank if actuator style AP1 (no frame)

**OR**
**5 BUSHING**
**BD** Big bushing for PC, PD actuator 15/32"

**B10** Threaded 1/4 - 40

**B20** Unthreaded

**B21** Unthreaded with flat

NOTE: For CAP options, see ordering scheme on page 35.

## 3MN-Series Dimensional Specifications: in. [mm]

### PLUNGER

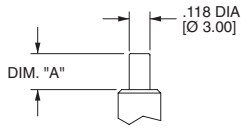

OPTION CODE	DIM. "A"
P0	.000 [0.00]
P1	.205 [5.20]
P2	.079 [2.00]

FOR B10,B11,B20,B21 ONLY

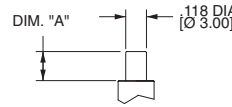

OPTION CODE	DIM. "A"
P0	.098 [2.50]
P1	.295 [7.50]
P2	.165 [4.20]

FOR B6 ONLY

### ACTUATOR

#### AP1

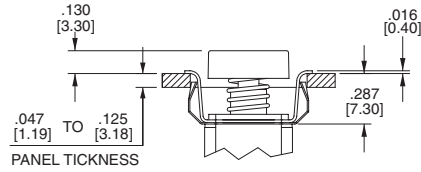
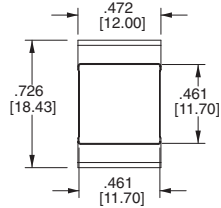

#### PANEL MOUNTING

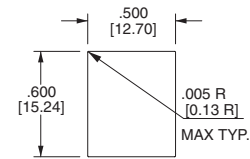

#### AP2

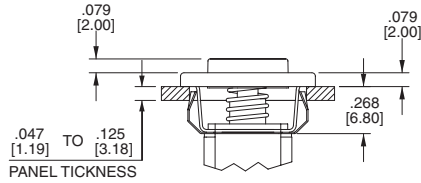
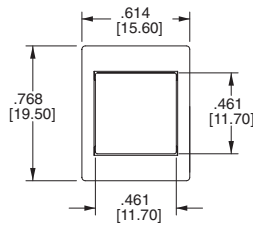

#### PANEL MOUNTING

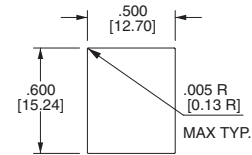

#### AP3

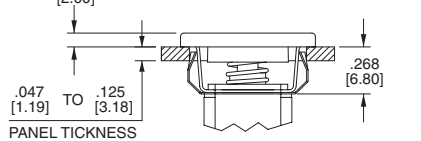
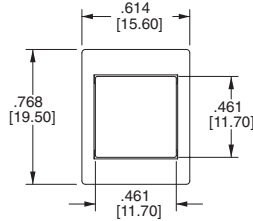

### BUSHING

**B10**  
STANDARD KEYWAY  
THREADED SHOWN

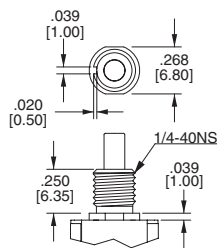

**B20**  
STANDARD KEYWAY  
NON-THREADED

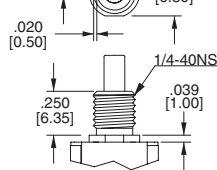

**B11**  
THREADED SHOWN  
WITH FLAT

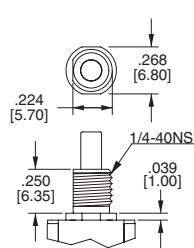

**B21**  
NON-THREADED  
WITH FLAT

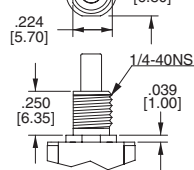

**B6**  
NON-THREADED  
(FOR TERMINATION  
OPTIONS VS6-VS9 ONLY)

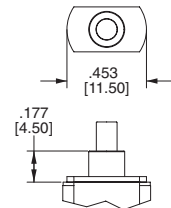

### CAP

#### C1

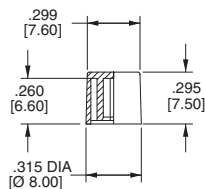

#### C2

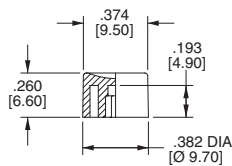

#### C3

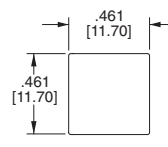

#### C4

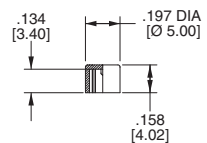

## 3MN-Series Dimensional Specifications: in. [mm]

### TERMINATION

**M1**

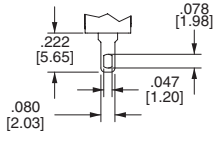

THK .030 [0.75]

**M2**

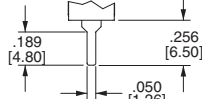

THK .030 [0.75]

**M5**

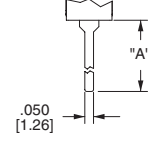

THK .030 [0.75]

OPTION CODE	DIM. "A"
M5-1	.750 [19.05]
M5-3	.425 [10.80]

### SINGLE POLE

### DOUBLE POLE

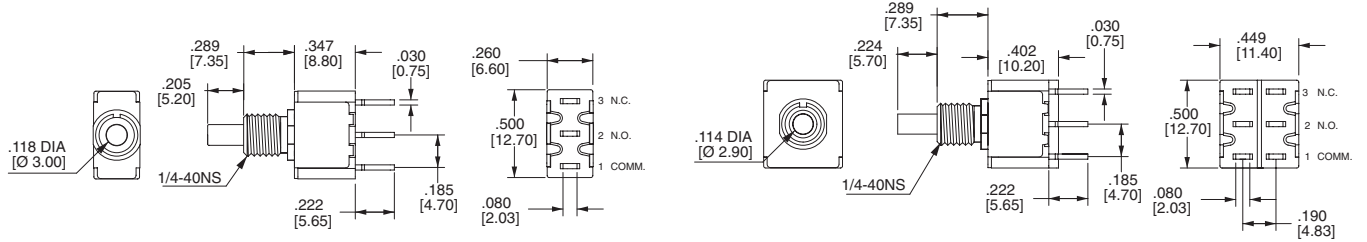

**M6**

### SINGLE POLE

### PC MOUNTING

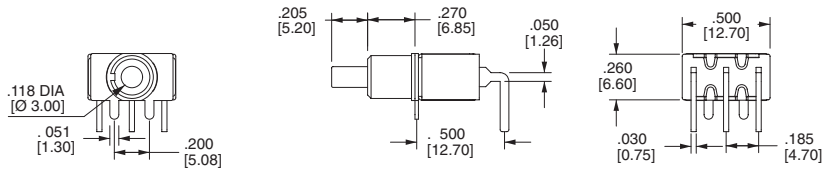

### DOUBLE POLE

### PC MOUNTING

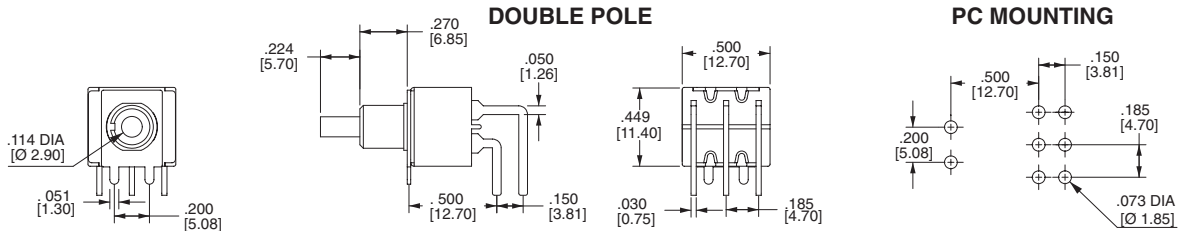

**M7**

### SINGLE POLE

### PC MOUNTING

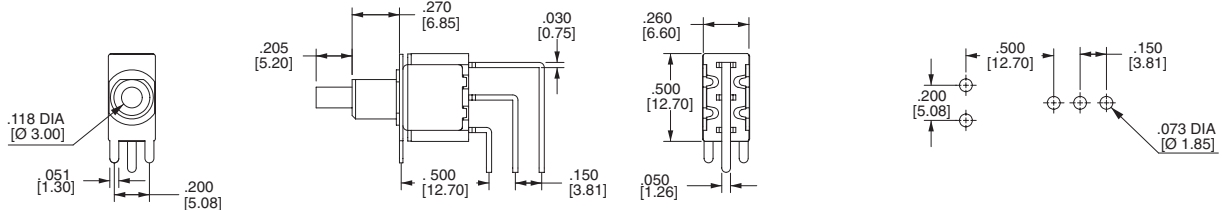

### DOUBLE POLE

### PC MOUNTING

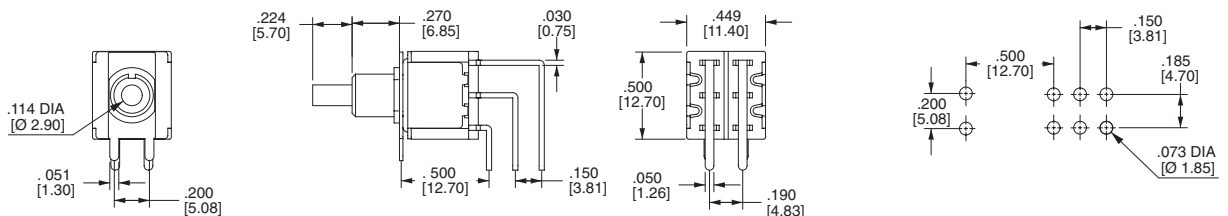

## 3MN-Series Dimensional Specifications: in. [mm]

### TERMINATION

#### SINGLE POLE

OPTION CODE	DIM. "A"
VS2	.460 [11.68]
VS3	.630 [16.00]
VS7	[16.00]

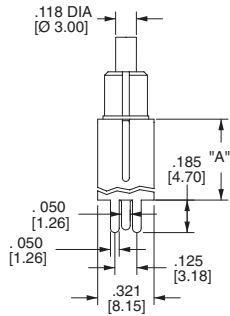

#### PC MOUNTING

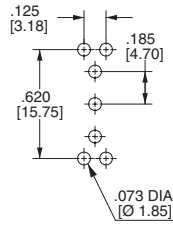

#### VS2-VS3

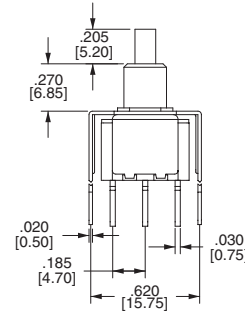

#### VS6-VS7 (For B6 Bushing Only)

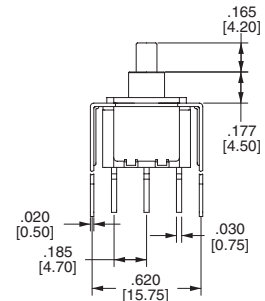

#### DOUBLE POLE

OPTION CODE	DIM. "A"
VS2	.460 [11.68]
VS6	.630 [16.00]
VS7	[16.00]

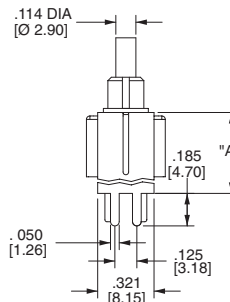

#### PC MOUNTING

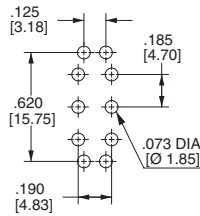

#### VS2-VS3

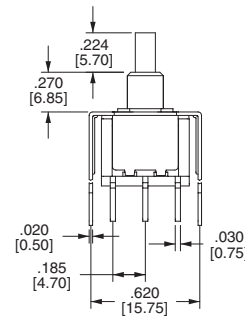

#### VS6-VS7 (For B6 Bushing Only)

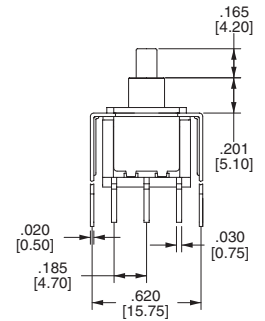

#### SINGLE POLE

OPTION CODE	DIM. "A"
VS4	.460 [11.68]
VS8	.630 [16.00]
VS9	[16.00]

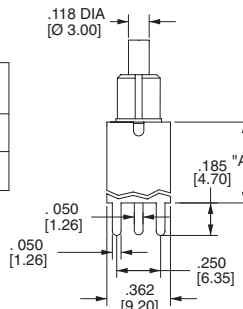

#### PC MOUNTING

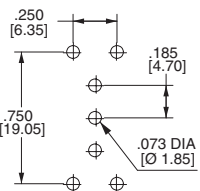

#### VS4-VS5

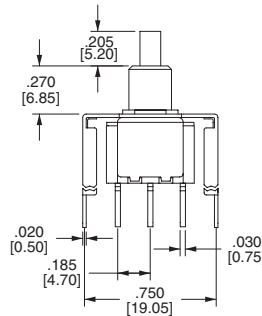

#### VS8-VS9 (For B6 Bushing Only)

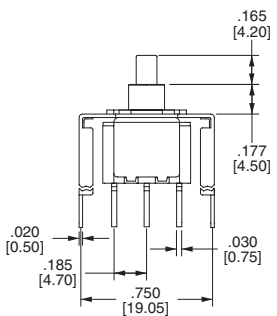

#### DOUBLE POLE

OPTION CODE	DIM. "A"
VS4	.460 [11.68]
VS8	.630 [16.00]
VS9	[16.00]

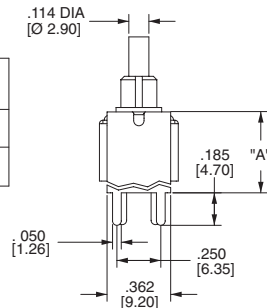

#### PC MOUNTING

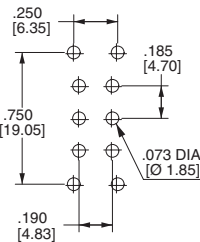

#### VS4-VS5

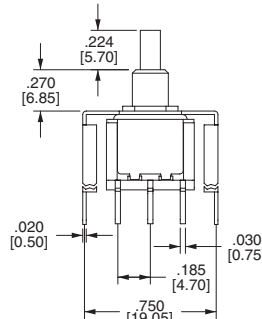

#### VS8-VS9 (For B6 Bushing Only)

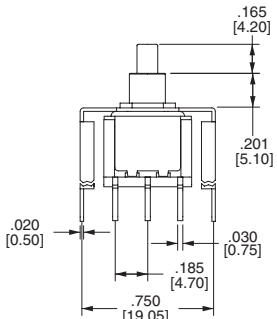

## 3MS-Series Dimensional Specifications: in. [mm]

### PLUNGER

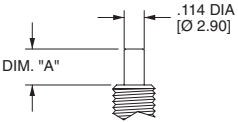
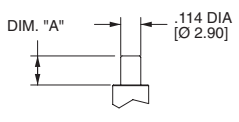
 <p>DIM. "A"</p> <p>.114 DIA [Ø 2.90]</p> <table border="1"> <thead> <tr> <th>OPTION CODE</th> <th>DIM. "A"</th> </tr> </thead> <tbody> <tr> <td><b>P1</b></td> <td>.173 [4.40]</td> </tr> <tr> <td><b>P2</b></td> <td>.220 [5.60]</td> </tr> <tr> <td><b>P3</b></td> <td>.087 [2.20]</td> </tr> </tbody> </table> <p>FOR B1 BUSHING</p>	OPTION CODE	DIM. "A"	<b>P1</b>	.173 [4.40]	<b>P2</b>	.220 [5.60]	<b>P3</b>	.087 [2.20]	 <p>DIM. "A"</p> <p>.114 DIA [Ø 2.90]</p> <table border="1"> <thead> <tr> <th>OPTION CODE</th> <th>DIM. "A"</th> </tr> </thead> <tbody> <tr> <td><b>P1</b></td> <td>.276 [7.00]</td> </tr> <tr> <td><b>P2</b></td> <td>.327 [8.30]</td> </tr> <tr> <td><b>P3</b></td> <td>.193 [4.90]</td> </tr> </tbody> </table> <p>FOR B4 BUSHING</p>	OPTION CODE	DIM. "A"	<b>P1</b>	.276 [7.00]	<b>P2</b>	.327 [8.30]	<b>P3</b>	.193 [4.90]
OPTION CODE	DIM. "A"																
<b>P1</b>	.173 [4.40]																
<b>P2</b>	.220 [5.60]																
<b>P3</b>	.087 [2.20]																
OPTION CODE	DIM. "A"																
<b>P1</b>	.276 [7.00]																
<b>P2</b>	.327 [8.30]																
<b>P3</b>	.193 [4.90]																

### BUSHING

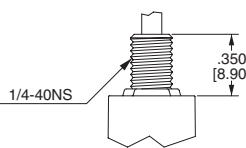
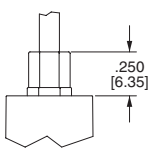
<p><b>B1</b></p>  <p>1/4-40NS</p> <p>.350 [8.90]</p>	<p><b>B4</b></p>  <p>.250 [6.35]</p>
---	---

### TERMINATION

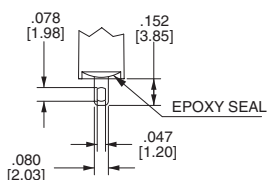
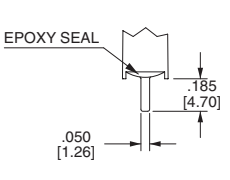
<p><b>M1</b></p>  <p>.078 [1.98]</p> <p>.152 [3.85]</p> <p>EPOXY SEAL</p> <p>.047 [1.20]</p> <p>.080 [2.03]</p> <p>THK .030 [0.75]</p>	<p><b>M2</b></p>  <p>EPOXY SEAL</p> <p>.185 [4.70]</p> <p>.050 [1.26]</p> <p>THK .030 [0.75]</p>
--	--

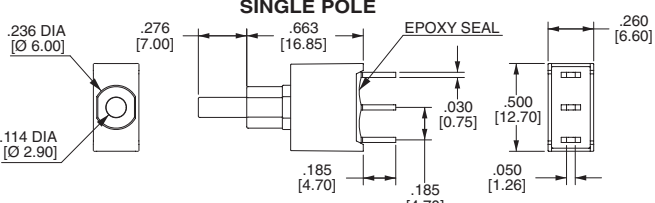
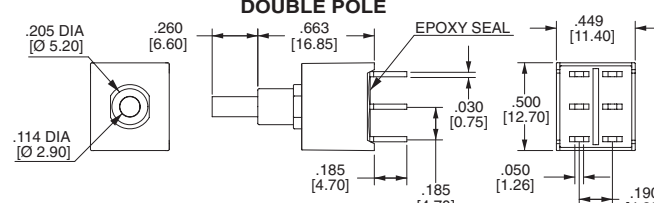
<p><b>SINGLE POLE</b></p>  <p>.236 DIA [Ø 6.00]</p> <p>.276 [7.00]</p> <p>.663 [16.85]</p> <p>EPOXY SEAL</p> <p>.260 [6.60]</p> <p>.030 [0.75]</p> <p>.500 [12.70]</p> <p>.185 [4.70]</p> <p>.185 [4.70]</p> <p>.050 [1.26]</p>	<p><b>DOUBLE POLE</b></p>  <p>.205 DIA [Ø 5.20]</p> <p>.260 [6.60]</p> <p>.663 [16.85]</p> <p>EPOXY SEAL</p> <p>.449 [11.40]</p> <p>.030 [0.75]</p> <p>.500 [12.70]</p> <p>.185 [4.70]</p> <p>.185 [4.70]</p> <p>.050 [1.26]</p> <p>.190 [4.83]</p>
--	---

### M6

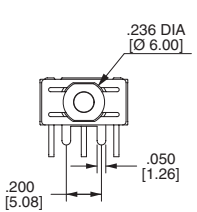
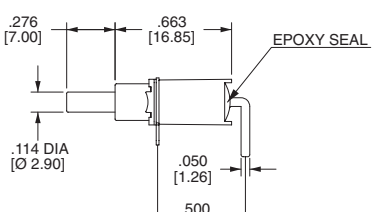
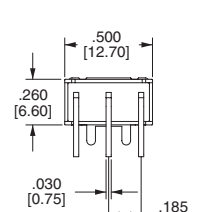
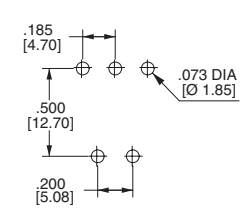
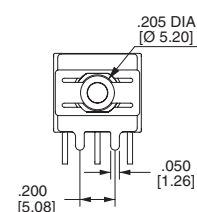
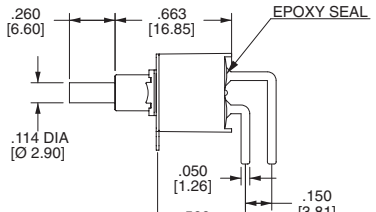
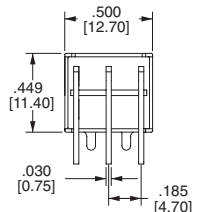
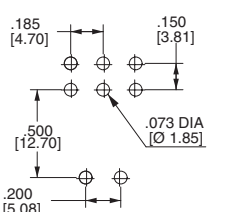
 <p>.236 DIA [Ø 6.00]</p> <p>.050 [1.26]</p> <p>.200 [5.08]</p>	<p><b>SINGLE POLE</b></p>  <p>.276 [7.00]</p> <p>.663 [16.85]</p> <p>EPOXY SEAL</p> <p>.114 DIA [Ø 2.90]</p> <p>.050 [1.26]</p> <p>.500 [12.70]</p>	 <p>.500 [12.70]</p> <p>.260 [6.60]</p> <p>.030 [0.75]</p> <p>.185 [4.70]</p>	<p><b>PC MOUNTING</b></p>  <p>.185 [4.70]</p> <p>.500 [12.70]</p> <p>.200 [5.08]</p> <p>.073 DIA [Ø 1.85]</p>
 <p>.205 DIA [Ø 5.20]</p> <p>.050 [1.26]</p> <p>.200 [5.08]</p>	<p><b>DOUBLE POLE</b></p>  <p>.260 [6.60]</p> <p>.663 [16.85]</p> <p>EPOXY SEAL</p> <p>.114 DIA [Ø 2.90]</p> <p>.050 [1.26]</p> <p>.500 [12.70]</p> <p>.150 [3.81]</p>	 <p>.500 [12.70]</p> <p>.449 [11.40]</p> <p>.030 [0.75]</p> <p>.185 [4.70]</p>	<p><b>PC MOUNTING</b></p>  <p>.185 [4.70]</p> <p>.150 [3.81]</p> <p>.500 [12.70]</p> <p>.200 [5.08]</p> <p>.073 DIA [Ø 1.85]</p>

## 3MS-Series Dimensional Specifications: in. [mm]

### TERMINATION

**M7**

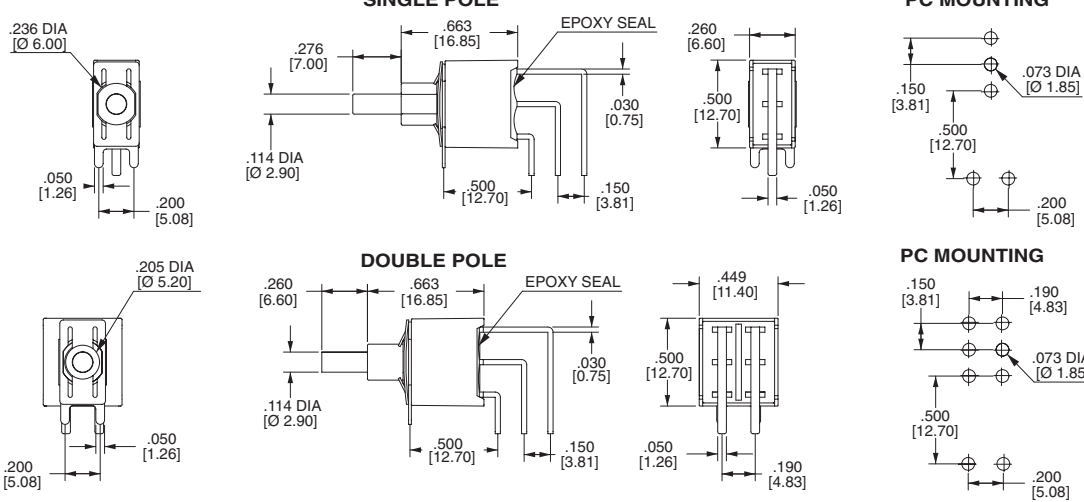

**VS2-VS3**

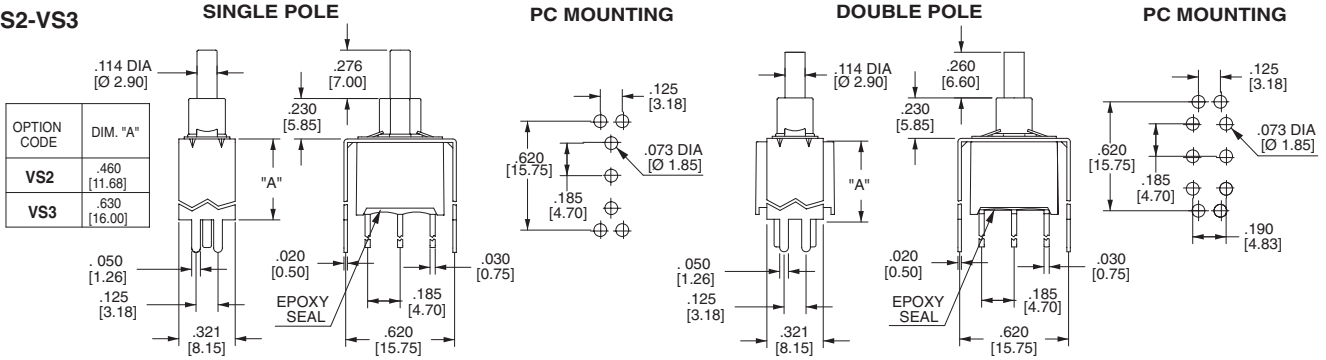

**VS4-VS5**

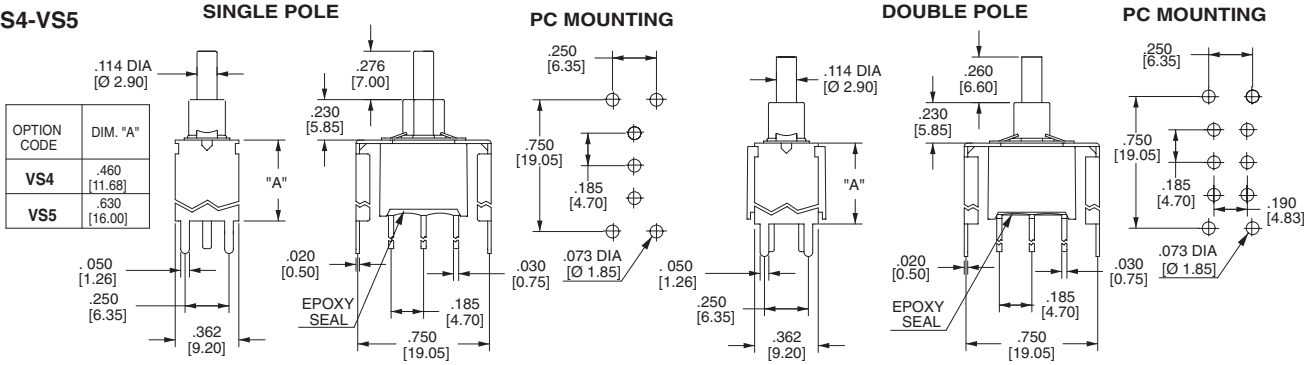

### SNAP-IN TERMINATION OPTIONS

**M61**



**M71**

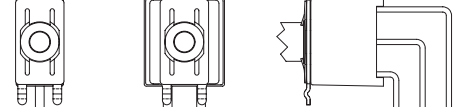

**VS21, VS31**

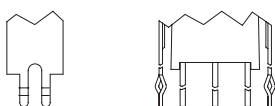

**VS41, VS51**



M61, M71, VS21, VS31, VS41, VS51 have the same P.C. mounting but with snap-in bracket.

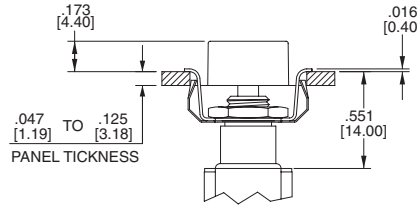
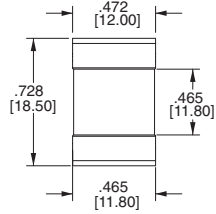
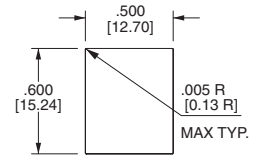
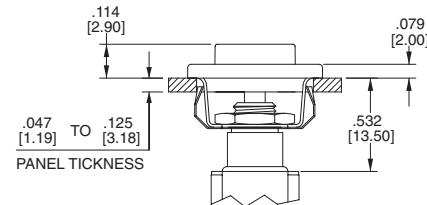
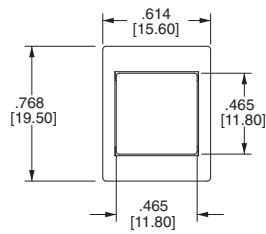
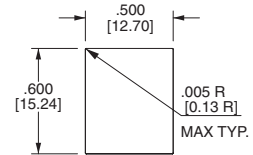
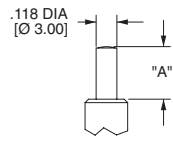

**3MA-Series Dimensional Specifications: in. [mm]**
**ACTUATOR**
**AP1**

**PANEL MOUNTING**

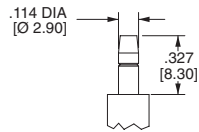
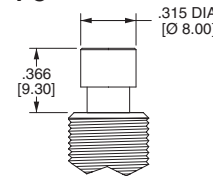
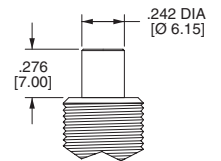
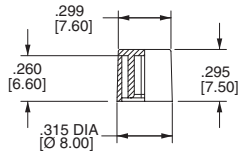
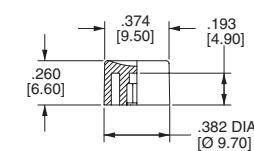
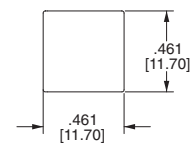
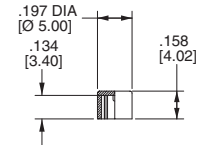
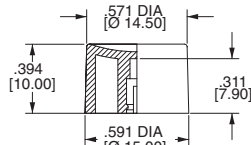
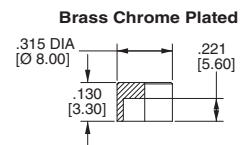
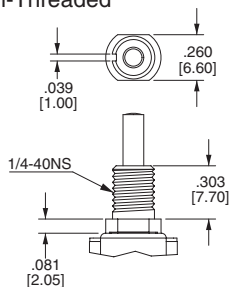
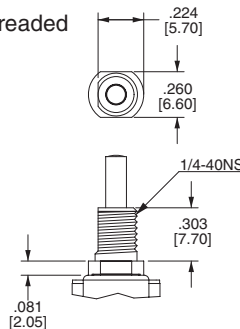
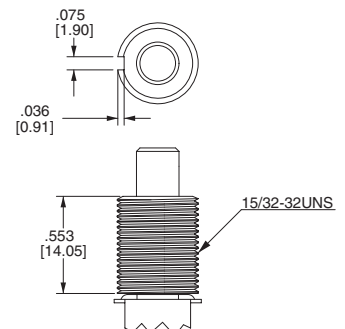
**AP2**

**PANEL MOUNTING**

**PLUNGER**
**PA,PI**

OPTION CODE	DIM. "A"
PA	.299 [7.60]
PI	.244 [6.20]

**PL**

**PC**

**PD**

**PC, PD Plunger must fit with BD bushing**
**CAP**
**C1**

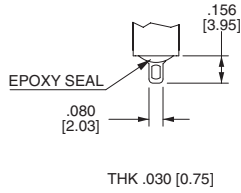
**C2**

**C3**

**C4**

**C5**

**For PL Bushing Only**
**C6**

**For PD Bushing Only**
**BUSHING**
**B10 Threaded  
B20 Non-Threaded**

**B21 Non-Threaded**

**BD**

**3MA-Series Dimensional Specifications: in. [mm]**

**TERMINATION**

**M1**



**M2**

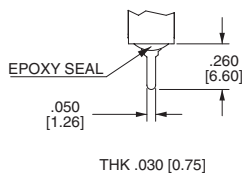

**M5**

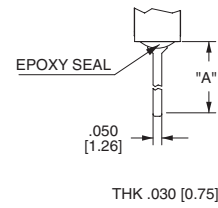

OPTION CODE	DIM. "A"
<b>M5-1</b>	.750 [19.05]
<b>M5-2</b>	.964 [24.48]
<b>M5-3</b>	.425 [10.80]
<b>M5-4</b>	1.062 [26.97]

**SINGLE POLE**

**DOUBLE POLE**

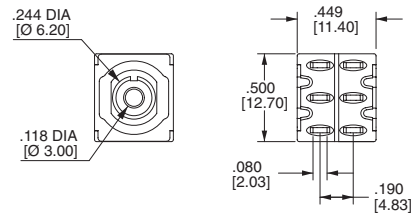
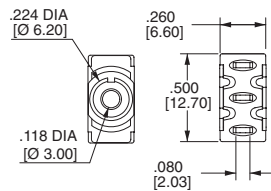
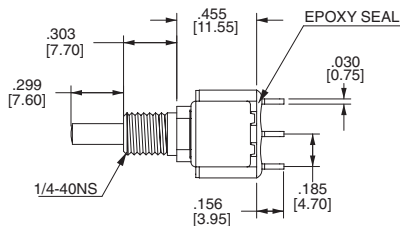

**3 POLE**

**4 POLE**

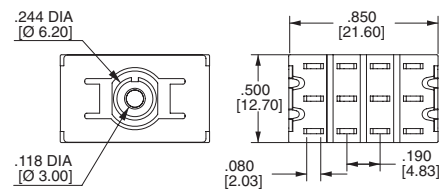
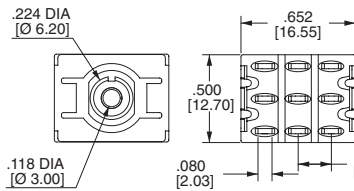
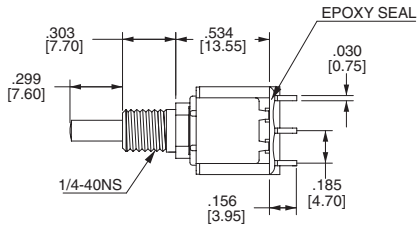

**M6**

**SINGLE POLE**

**PC MOUNTING**

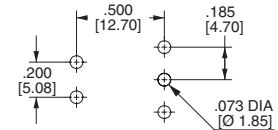
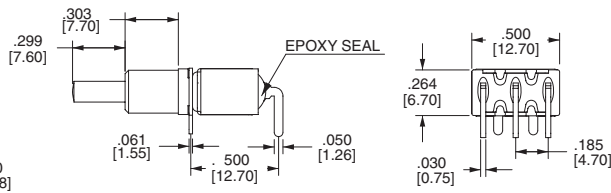
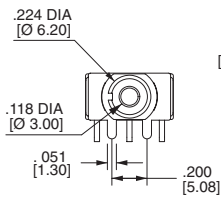

**DOUBLE POLE**

**PC MOUNTING**

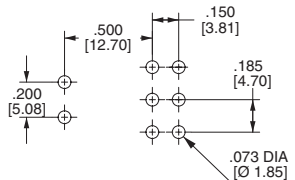
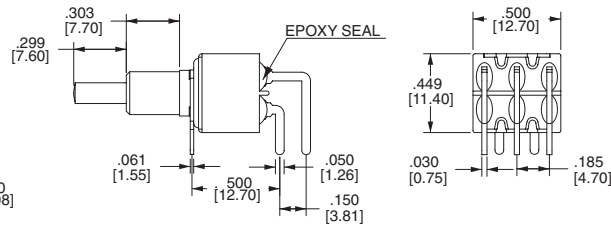
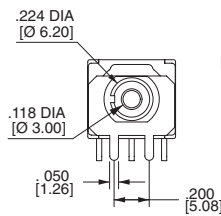

## 3MA-Series Dimensional Specifications: in. [mm]

### TERMINATION

M7

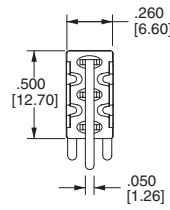
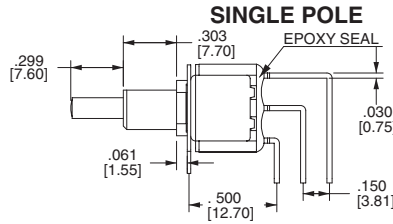
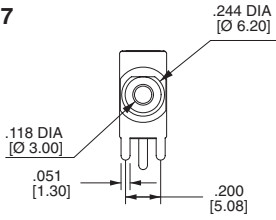

PC MOUNTING

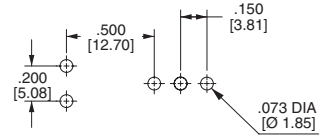

DOUBLE POLE

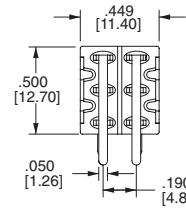
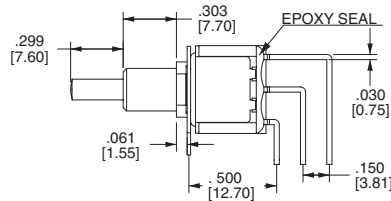
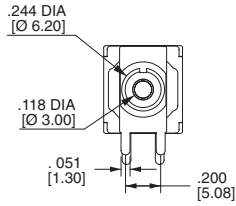

PC MOUNTING

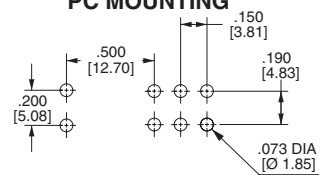

THREE POLE

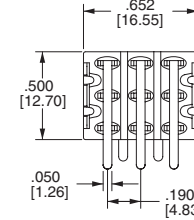
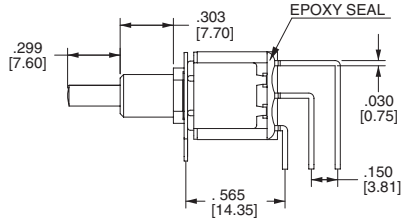
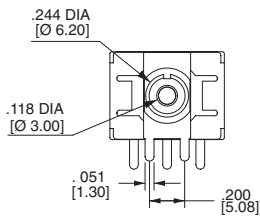

PC MOUNTING

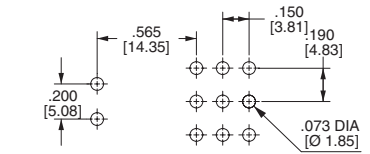

FOUR POLE

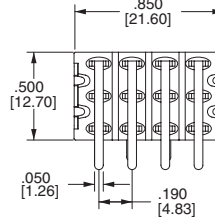
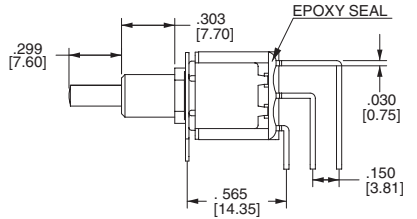
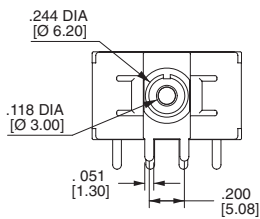

PC MOUNTING

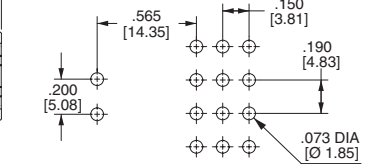

VS2-VS3

OPTION CODE	DIM. "A"
VS2	.460 [11.68]
VS3	.630 [16.00]

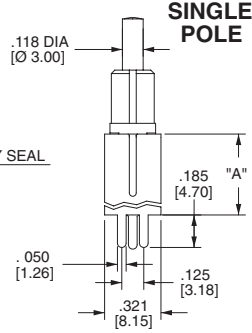
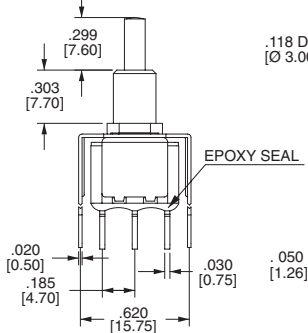

SINGLE POLE PC MOUNTING

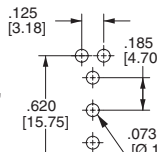

DOUBLE POLE PC MOUNTING

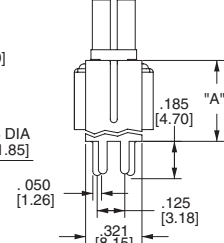

DOUBLE POLE PC MOUNTING

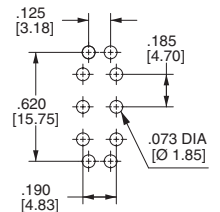

VS4-VS5

OPTION CODE	DIM. "A"
VS4	.460 [11.68]
VS5	.630 [16.00]

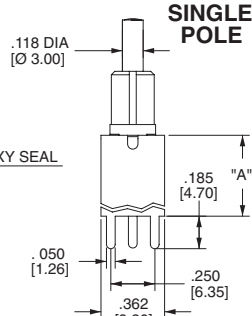
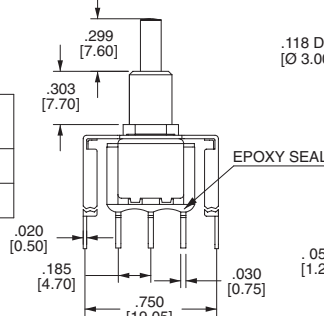

SINGLE POLE PC MOUNTING

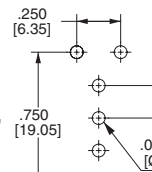

DOUBLE POLE PC MOUNTING

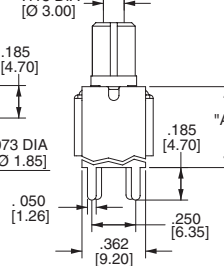

DOUBLE POLE PC MOUNTING

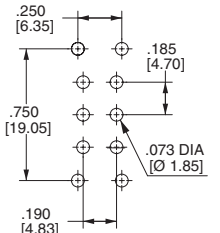

Компания «Life Electronics» занимается поставками электронных компонентов импортного и отечественного производства от производителей и со складов крупных дистрибьюторов Европы, Америки и Азии.

С конца 2013 года компания активно расширяет линейку поставок компонентов по направлению коаксиальный кабель, кварцевые генераторы и конденсаторы (керамические, пленочные, электролитические), за счёт заключения дистрибьюторских договоров

Мы предлагаем:

- Конкурентоспособные цены и скидки постоянным клиентам.
- Специальные условия для постоянных клиентов.
- Подбор аналогов.
- Поставку компонентов в любых объемах, удовлетворяющих вашим потребностям.
- Приемлемые сроки поставки, возможна ускоренная поставка.
- Доставку товара в любую точку России и стран СНГ.
- Комплексную поставку.
- Работу по проектам и поставку образцов.
- Формирование склада под заказчика.
- Сертификаты соответствия на поставляемую продукцию (по желанию клиента).
- Тестирование поставляемой продукции.
- Поставку компонентов, требующих военную и космическую приемку.
- Входной контроль качества.
- Наличие сертификата ISO.

В составе нашей компании организован Конструкторский отдел, призванный помогать разработчикам, и инженерам.

Конструкторский отдел помогает осуществить:

- Регистрацию проекта у производителя компонентов.
- Техническую поддержку проекта.
- Защиту от снятия компонента с производства.
- Оценку стоимости проекта по компонентам.
- Изготовление тестовой платы монтаж и пусконаладочные работы.



Тел: +7 (812) 336 43 04 (многоканальный)

Email: [org@lifeelectronics.ru](mailto:org@lifeelectronics.ru)