



# LIS344ALH

## MEMS inertial sensor

### high performance 3-axis $\pm 2/\pm 6$ g ultracompact linear accelerometer

#### Features

- 2.4 V to 3.6 V single supply operation
- $\pm 2$  g /  $\pm 6$  g user selectable full-scale
- Low power consumption
- Output voltage, offset and sensitivity are ratiometric to the supply voltage
- Factory trimmed device sensitivity and offset
- Embedded self test
- RoHS/ECOPACK<sup>®</sup> compliant
- High shock survivability ( 10000 g )

#### Description

The LIS344ALH is an ultra compact consumer low-power three-axis linear accelerometer that includes a sensing element and an IC interface able to take the information from the sensing element and to provide an analog signal to the external world.

The sensing element, capable of detecting the acceleration, is manufactured using a dedicated process developed by ST to produce inertial sensors and actuators in silicon.

The IC interface is manufactured using an ST proprietary CMOS process with high level of integration. The dedicated circuit is trimmed to better match the sensing element characteristics.

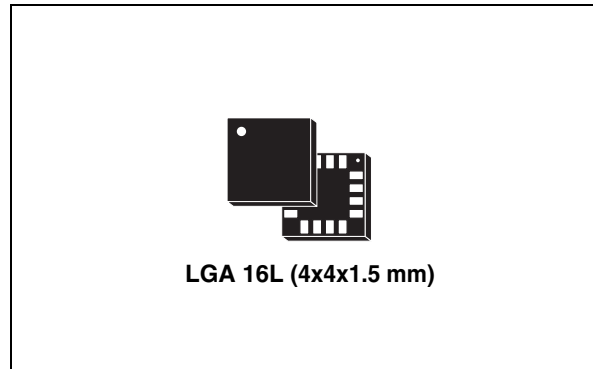

The LIS344ALH has a dynamically user selectable full-scale of  $\pm 2$  g /  $\pm 6$  g and it is capable of measuring accelerations over a maximum bandwidth of 1.8 kHz for all axes. The device bandwidth may be reduced by using external capacitances. The self-test capability allows the user to check the functioning of the system.

The LIS344ALH is available in Land Grid Array package (LGA) manufactured by ST. It is guaranteed to operate over an extended temperature range of  $-40$  °C to  $+85$  °C.

The LIS344ALH belongs to a family of products suitable for a variety of applications:

- Mobile terminals
- Gaming and virtual reality input devices
- Antitheft systems and inertial navigation
- Appliance and robotics.

Table 1. Device summary

Order codes	Temp range [°C]	Package	Packaging
LIS344ALH	-40 to +85	LGA-16L	Tray
LIS344ALHTR	-40 to +85	LGA-16L	Tape and reel

# Content

<b>1</b>	<b>Block diagram and pin description</b> .....	<b>5</b>
1.1	Block diagram .....	5
1.2	Pin description .....	5
<b>2</b>	<b>Mechanical and electrical specifications</b> .....	<b>7</b>
2.1	Mechanical characteristics .....	7
2.2	Electrical characteristics .....	8
2.3	Absolute maximum ratings .....	9
2.4	Terminology .....	10
<b>3</b>	<b>Functionality</b> .....	<b>11</b>
3.1	Sensing element .....	11
3.2	IC interface .....	11
3.3	Factory calibration .....	11
<b>4</b>	<b>Application hints</b> .....	<b>12</b>
4.1	Soldering information .....	13
4.2	Output response vs orientation .....	13
<b>5</b>	<b>Typical performance characteristics</b> .....	<b>14</b>
5.1	Mechanical characteristics at 25 °C .....	14
5.2	Mechanical characteristics derived from measurement in the -40 °C to +85 °C temperature range .....	15
5.3	Electrical characteristics at 25 °C .....	16
<b>6</b>	<b>Package information</b> .....	<b>17</b>
<b>7</b>	<b>Revision history</b> .....	<b>18</b>

## List of figures

Figure 1.	Block diagram . . . . .	5
Figure 2.	Pin connection . . . . .	5
Figure 3.	LIS344ALH electrical connection . . . . .	12
Figure 4.	Output response vs orientation . . . . .	13
Figure 5.	X axis Zero-g level at 3.3 V . . . . .	14
Figure 6.	X axis Sensitivity at 3.3 V . . . . .	14
Figure 7.	Y axis Zero-g level at 3.3 V . . . . .	14
Figure 8.	Y axis Sensitivity at 3.3 V . . . . .	14
Figure 9.	Z axis Zero-g level at 3.3 V . . . . .	14
Figure 10.	Z axis Sensitivity at 3.3 V . . . . .	14
Figure 11.	X axis Zero-g level change vs. temperature at 3.3 V . . . . .	15
Figure 12.	X axis Sensitivity change vs. temperature at 3.3 V . . . . .	15
Figure 13.	Y axis Zero-g level change vs. temperature at 3.3 V . . . . .	15
Figure 14.	Y axis Sensitivity change vs. temperature at 3.3 V . . . . .	15
Figure 15.	Z axis Zero-g level change vs. temperature at 3.3 V . . . . .	15
Figure 16.	Z axis Sensitivity change vs. temperature at 3.3 V . . . . .	15
Figure 17.	Current consumption in normal mode at 3.3 V . . . . .	16
Figure 18.	Current consumption in power-down at 3.3 V . . . . .	16
Figure 19.	Noise density at 3.3 V (X, Y axis) . . . . .	16
Figure 20.	Noise density at 3.3 V (Z axis) . . . . .	16
Figure 21.	LGA 16: mechanical data and package dimensions . . . . .	17

## List of tables

Table 1.	Device summary . . . . .	1
Table 2.	Pin description . . . . .	6
Table 3.	Mechanical characteristics @ Vdd =3.3 V, T = 25 °C unless otherwise noted . . . . .	7
Table 4.	Electrical characteristics @ Vdd =3.3 V, T = 25 °C unless otherwise noted . . . . .	8
Table 5.	Absolute maximum ratings . . . . .	9
Table 6.	Filter capacitor selection, C <sub>load</sub> (x, y, z), . . . . .	13
Table 7.	Document revision history . . . . .	18

# 1 Block diagram and pin description

## 1.1 Block diagram

Figure 1. Block diagram

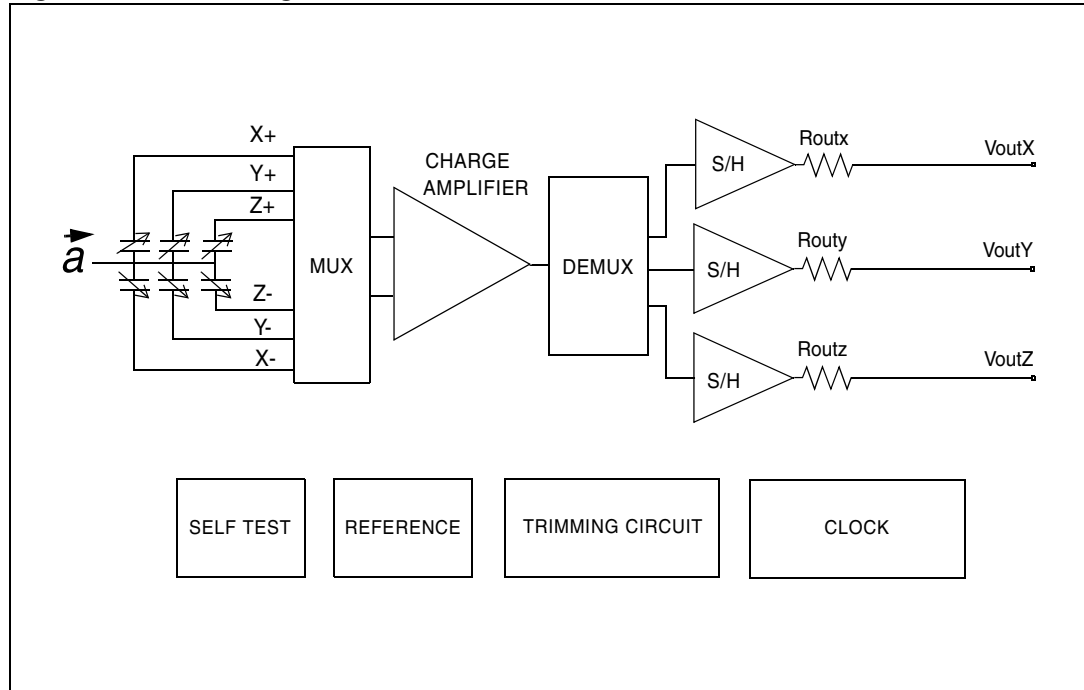

## 1.2 Pin description

Figure 2. Pin connection

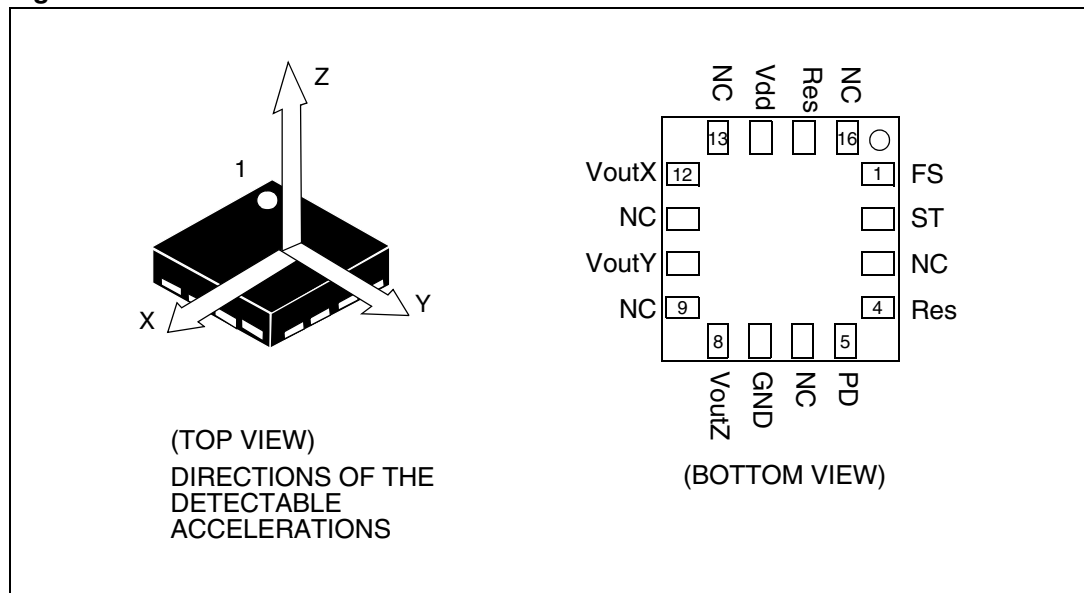

**Table 2. Pin description**

Pin #	Pin name	Function
1	FS	Full scale selection (logic 0: $\pm 2g$ full-scale; logic 1: $\pm 6g$ full-scale)
2	ST	Self test (logic 0: normal mode; logic 1: self-test mode)
3	NC	Internally not connected
4	Res	Leave unconnected or connect to Vdd
5	PD	Power down (logic 0: normal mode; logic 1: power-down mode)
6	NC	Internally not connected
7	GND	0 V supply
8	VoutZ	Output voltage Z channel
9	NC	Internally not connected
10	VoutY	Output voltage Y channel
11	NC	Internally not connected
12	VoutX	Output voltage X channel
13	NC	Internally not connected
14	Vdd	Power supply
15	Res	Connect to Vdd
16	NC	Internally not connected

## 2 Mechanical and electrical specifications

### 2.1 Mechanical characteristics

**Table 3. Mechanical characteristics @ Vdd =3.3 V, T = 25 °C unless otherwise noted<sup>(1)</sup>**

Symbol	Parameter	Test condition	Min.	Typ. <sup>(2)</sup>	Max.	Unit
Ar	Acceleration range <sup>(3)</sup>	FS pin connected to GND	±1.8	± 2		g
		FS pin connected to Vdd	±5.4	± 6		
So	Sensitivity <sup>(4)</sup>	Full-scale = ±2 g	Vdd/5 - 5%	Vdd/5	Vdd/5 + 5%	V/g
		Full-scale = ±6 g	Vdd/15 - 10%	Vdd/15	Vdd/15 + 10%	
SoDr	Sensitivity change Vs Temperature	Delta from +25 °C		± 0.01		%/°C
Voff	Zero-g level <sup>(4)</sup>	Full-scale = ±2 g T = 25 °C	Vdd/2 - 5%	Vdd/2	Vdd/2 + 5%	V
OffDr	Zero-g level change Vs Temperature	Delta from +25 °C		±0.4		mg/°C
NL	Non linearity <sup>(5)</sup>	Best fit straight line Full-scale = ±2 g		±0.5		% FS
CrossAx	Cross-axis <sup>(6)</sup>			±2		%
An	Acceleration noise density	Vdd = 3.3 V; Full-scale = ±2 g		50		µg/√Hz
Vt	Self test output voltage change <sup>(7),(8),(9)</sup>	X axis T = 25 °C; Vdd=3.3 V	80	140	200	mV
		Y axis T = 25 °C; Vdd=3.3 V	-200	-140	-80	mV
		Z axis T = 25 °C; Vdd=3.3 V	100	230	350	mV
Fres	Sensing element resonant frequency <sup>(10)</sup>	X,Y,Z axis	1.8			KHz
Top	Operating temperature range		-40		+85	°C
Wh	Product weight			0.040		gram

1. The product is factory calibrated at 3.3 V. The operational power supply range is from 2.4 V to 3.6 V. Voff, So and Vt parameters will vary with supply voltage.
2. Typical specifications are not guaranteed.
3. Guaranteed by wafer level test and measurement of initial offset and sensitivity.
4. Zero-g level and sensitivity are essentially ratiometric to supply voltage at the calibration level ±8%.
5. Guaranteed by design.
6. Contribution to the measuring output of an inclination/acceleration along any perpendicular axis.
7. "Self test output voltage change" is defined as  $V_{out}(V_{st=Logic1}) - V_{out}(V_{st=Logic0})$ .
8. "Self test output voltage change" varies cubically with supply voltage.
9. When full-scale is set to ±6 g. "Self test output voltage change" is one third of the specified value at ±2 g.
10. Minimum resonance frequency  $F_{res}=1.8$  kHz. Sensor bandwidth= $1/(2*\pi*110k\Omega*C_{load})$ , with  $C_{load}>1$  nF.

## 2.2 Electrical characteristics

**Table 4. Electrical characteristics @ Vdd =3.3 V, T = 25 °C unless otherwise noted<sup>(1)</sup>**

Symbol	Parameter	Test condition	Min.	Typ. <sup>(2)</sup>	Max.	Unit
Vdd	Supply voltage		2.4	3.3	3.6	V
Idd	Supply current	Normal mode		680	850	μA
		Power-down mode		1	5	
Vfs Vst Vpd	Full-scale input Self-test input Power-down input	Logic 0 level	0		0.3*Vdd	V
		Logic 1 level	0.7*Vdd		Vdd	V
Rout	Output impedance of VoutX, VoutY, VoutZ		90	110	130	KΩ
Cload	Capacitive load drive <sup>(3)</sup> for VoutX, VoutY, VoutZ		1			nF
Ton	Turn-on time at exit of Power-down mode	Cload expressed in μF		550*Cload+0.3		ms
Top	Operating temperature range		-40		+85	°C

1. The product is factory calibrated at 3.3 V.
2. Typical specifications are not guaranteed.
3. Minimum resonance frequency  $F_{res}=1.8$  kHz. Device bandwidth= $1/(2*\pi*110\text{ k}\Omega*Cload)$ , with  $Cload>1$  nF.



## 2.3 Absolute maximum ratings

Stresses above those listed as “Absolute maximum ratings” may cause permanent damage to the device. This is a stress rating only and functional operation of the device under these conditions is not implied. Exposure to maximum rating conditions for extended periods may affect device reliability.

**Table 5. Absolute maximum ratings**

Symbol	Ratings	Maximum value	Unit
V <sub>DD</sub>	Supply voltage	-0.3 to 7	V
V <sub>IN</sub>	Input voltage on any control pin (FS, ST, PD)	-0.3 to V <sub>DD</sub> +0.3	V
A <sub>POW</sub>	Acceleration (any axis, powered, V <sub>DD</sub> = 3.3 V)	3000 g for 0.5 ms	
		10000 g for 0.1 ms	
A <sub>UNP</sub>	Acceleration (any axis, not powered)	3000 g for 0.5 ms	
		10000 g for 0.1 ms	
T <sub>STG</sub>	Storage temperature range	-40 to +125	°C
ESD	Electrostatic discharge protection	4 (HBM)	KV
		1.5 (CDM)	KV
		400 (MM)	V



This is a mechanical shock sensitive device, improper handling can cause permanent damages to the part



This is an ESD sensitive device, improper handling can cause permanent damages to the part

## 2.4 Terminology

**Sensitivity** describes the gain of the sensor and can be determined by applying 1g acceleration to it. As the sensor can measure DC accelerations this can be done easily by pointing the axis of interest towards the center of the Earth, note the output value, rotate the sensor by 180 degrees (point to the sky) and note the output value again thus applying  $\pm 1g$  acceleration to the sensor. Subtracting the larger output value from the smaller one, and dividing the result by 2, will give the actual sensitivity of the sensor. This value changes very little over temperature (see sensitivity change vs temperature) and also very little over time. The Sensitivity tolerance describes the range of sensitivities of a large population of sensors.

**Zero-g level** describes the actual output signal if there is no acceleration present. A sensor in a steady state on a horizontal surface will measure 0 g in X axis and 0 g in Y axis whereas the Z axis will measure 1g. The output is ideally for a 3.3 V powered sensor  $V_{dd}/2 = 1650$  mV. A deviation from ideal 0-g level (1650 mV in this case) is called Zero-g offset. Offset of precise MEMS sensors is to some extent a result of stress to the sensor and therefore the offset can slightly change after mounting the sensor onto a printed circuit board or exposing it to extensive mechanical stress. Offset changes little over temperature - see "Zero-g level change vs temperature" - the Zero-g level of an individual sensor is very stable over lifetime. The Zero-g level tolerance describes the range of Zero-g levels of a population of sensors.

**Self test** allows to test the mechanical and electric part of the sensor, allowing the seismic mass to be moved by means of an electrostatic test-force. The Self Test function is off when the ST pin is connected to GND. When the ST pin is tied at Vdd an actuation force is applied to the sensor, simulating a definite input acceleration. In this case the sensor outputs will exhibit a voltage change in their DC levels which is related to the selected full-scale and depending on the supply voltage through the device sensitivity. When ST is activated, the device output level is given by the algebraic sum of the signals produced by the acceleration acting on the sensor and by the electrostatic test-force. If the output signals change within the amplitude specified inside [Table 3](#), then the sensor is working properly and the parameters of the interface chip are within the defined specification.

**Output impedance** describes the resistor inside the output stage of each channel. This resistor is part of a filter consisting of an external capacitor of at least 1 nF and the internal resistor. Due to the high resistor level, only small inexpensive external capacitors are needed to generate low corner frequencies. When interfacing with an ADC it is important to use high input impedance input circuitries to avoid measurement errors. Note that the minimum load capacitance forms a corner frequency close to the resonance frequency of the sensor. In general the smallest possible bandwidth for a particular application should be chosen to get the best results.

## 3 Functionality

The LIS344ALH is an ultra compact low-power, analog output three-axis linear accelerometer packaged in a LGA package. The complete device includes a sensing element and an IC interface able to take the information from the sensing element and to provide an analog signal to the external world.

### 3.1 Sensing element

A proprietary process is used to create a surface micro-machined accelerometer. The technology allows to carry out suspended silicon structures which are attached to the substrate in a few points called anchors and are free to move in the direction of the sensed acceleration. To be compatible with the traditional packaging techniques a cap is placed on top of the sensing element to avoid blocking the moving parts during the moulding phase of the plastic encapsulation.

When an acceleration is applied to the sensor the proof mass displaces from its nominal position, causing an imbalance in the capacitive half-bridge. This imbalance is measured using charge integration in response to a voltage pulse applied to the sense capacitor.

At steady state the nominal value of the capacitors are few pF and when an acceleration is applied the maximum variation of the capacitive load is in the fF range.

### 3.2 IC interface

The complete signal processing uses a fully differential structure, while the final stage converts the differential signal into a single-ended one to be compatible with the external world.

The first stage is a low-noise capacitive amplifier that implements a Correlated Double Sampling (CDS) at its output to cancel the offset and the  $1/f$  noise. The produced signal is then sent to three different S&Hs, one for each channel, and made available to the outside.

All the analog parameters (output offset voltage and sensitivity) are ratiometric to the voltage supply. Increasing or decreasing the voltage supply, the sensitivity and the offset will increase or decrease linearly. This feature provides the cancellation of the error related to the voltage supply along an analog to digital conversion chain.

### 3.3 Factory calibration

The IC interface is factory calibrated for sensitivity ( $S_0$ ) and Zero-g level ( $V_{off}$ ). The trimming values are stored inside the device by a non volatile structure. Any time the device is turned on, the trimming parameters are downloaded into the registers to be employed during the normal operation. This allows the user to employ the device without further calibration.

## 4 Application hints

Figure 3. LIS344ALH electrical connection

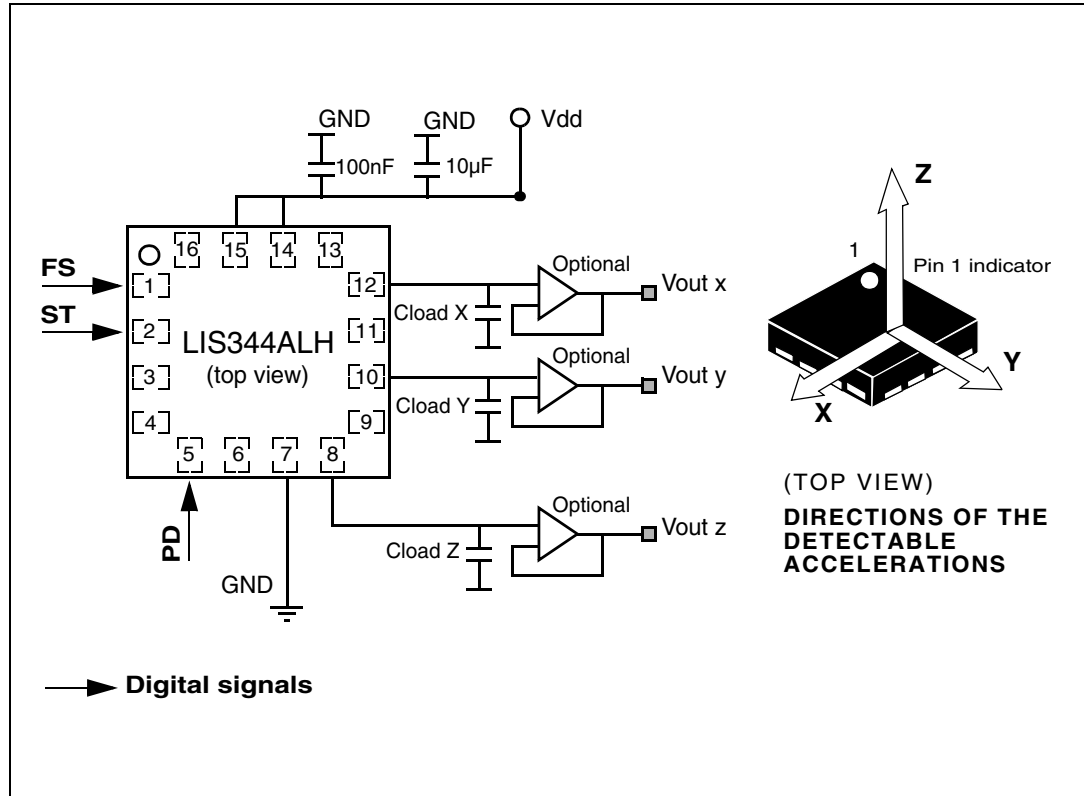

Power supply decoupling capacitors (100 nF ceramic or polyester + 10 µF Aluminum) should be placed as near as possible to the device (common design practice).

The LIS344ALH allows to band limit VoutX, VoutY and VoutZ through the use of external capacitors. The recommended frequency range spans from DC up to 1.8 kHz. In particular, capacitors are added at output VoutX, VoutY, VoutZ pins to implement low-pass filtering for antialiasing and noise reduction. The equation for the cut-off frequency ( $f_t$ ) of the external filters is in this case:

$$f_t = \frac{1}{2\pi \cdot R_{out} \cdot C_{load}(x, y, z)}$$

Taking into account that the internal filtering resistor ( $R_{out}$ ) has a nominal value equal to 110 KΩ the equation for the external filter cut-off frequency may be simplified as follows:

$$f_t = \frac{1.45\mu F}{C_{load}(x, y, z)} [Hz]$$

The tolerance of the internal resistor can vary typically of ±20% within its nominal value of 110 KΩ; thus the cut-off frequency will vary accordingly. A minimum capacitance of 1 nF for  $C_{load}(x, y, z)$  is required.

**Table 6. Filter capacitor selection,  $C_{load}$  (x, y, z),**

Cut-off frequency	Capacitor value
1 Hz	1500 nF
10 Hz	150 nF
20 Hz	68 nF
50 Hz	30 nF
100 Hz	15 nF
200 Hz	6.8 nF
500 Hz	3 nF

### 4.1 Soldering information

The LGA package is compliant with the ECOPACK, RoHS and “Green” standard. It is qualified for soldering heat resistance according to JEDEC J-STD-020C.

Leave “Pin 1 Indicator” unconnected during soldering.

Land pattern and soldering recommendations are available at [www.st.com/mems](http://www.st.com/mems).

### 4.2 Output response vs orientation

**Figure 4. Output response vs orientation**

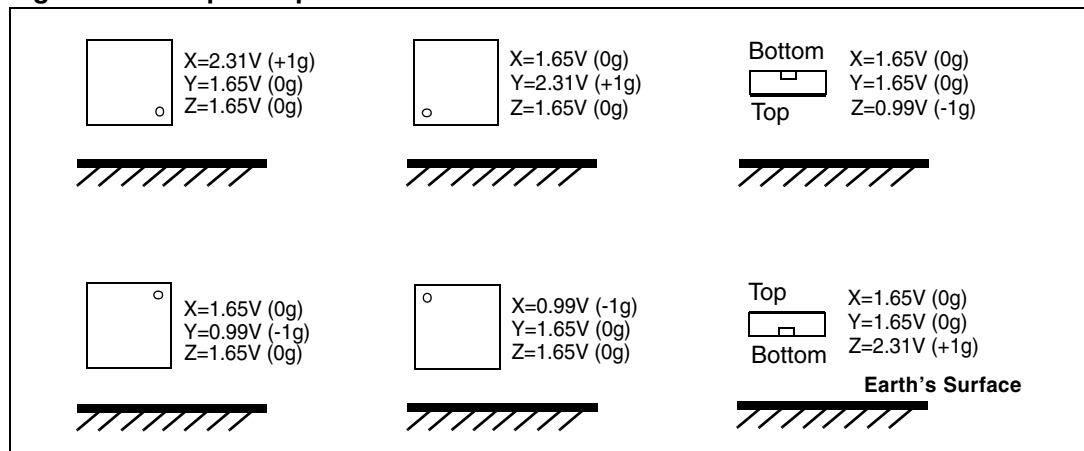

Figure 4 shows output voltage values of LIS344ALH, powered at 3.3 V, with full-scale  $\pm 2$  g.

## 5 Typical performance characteristics

### 5.1 Mechanical characteristics at 25 °C

Figure 5. X axis Zero-g level at 3.3 V

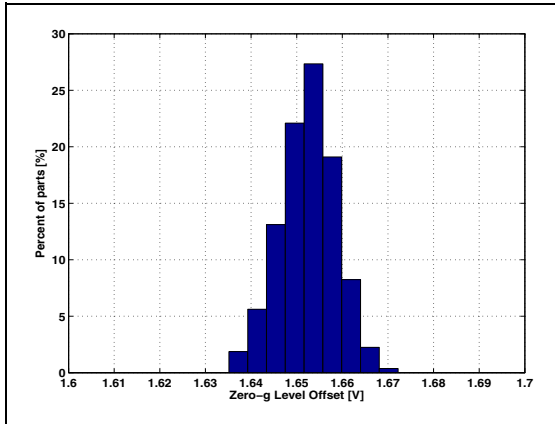

Figure 6. X axis Sensitivity at 3.3 V

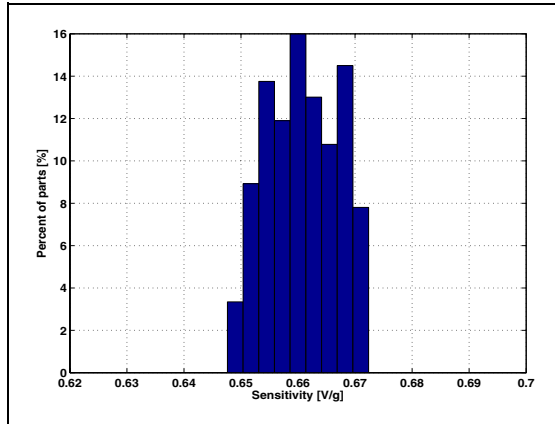

Figure 7. Y axis Zero-g level at 3.3 V

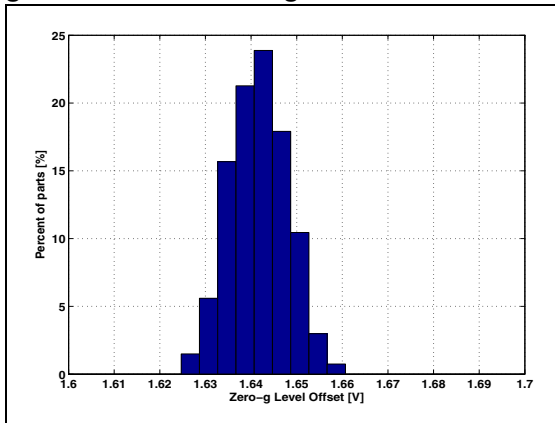

Figure 8. Y axis Sensitivity at 3.3 V

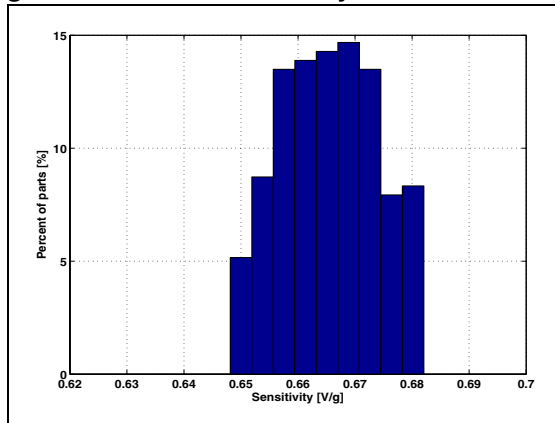

Figure 9. Z axis Zero-g level at 3.3 V

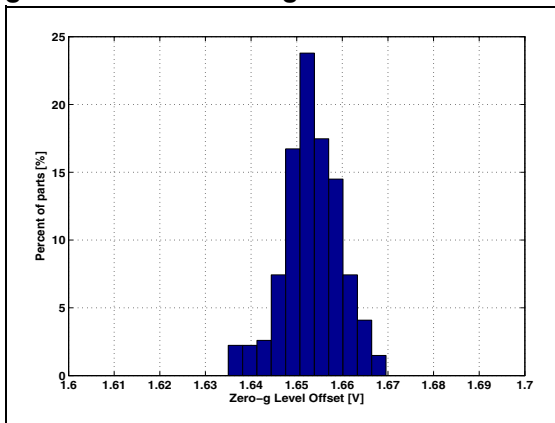
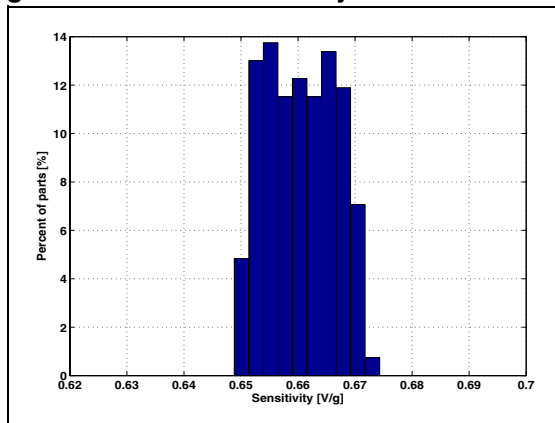

Figure 10. Z axis Sensitivity at 3.3 V



## 5.2 Mechanical characteristics derived from measurement in the -40 °C to +85 °C temperature range

Figure 11. X axis Zero-g level change vs. temperature at 3.3 V

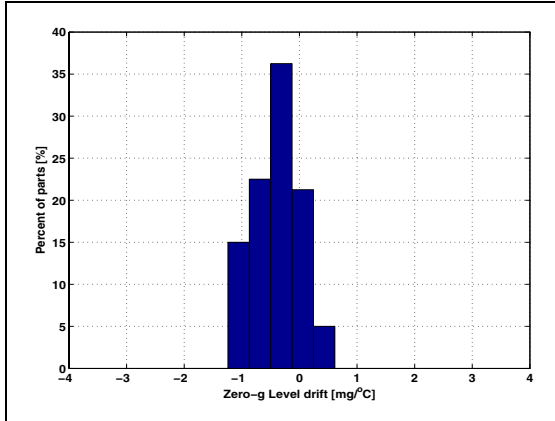

Figure 12. X axis Sensitivity change vs. temperature at 3.3 V

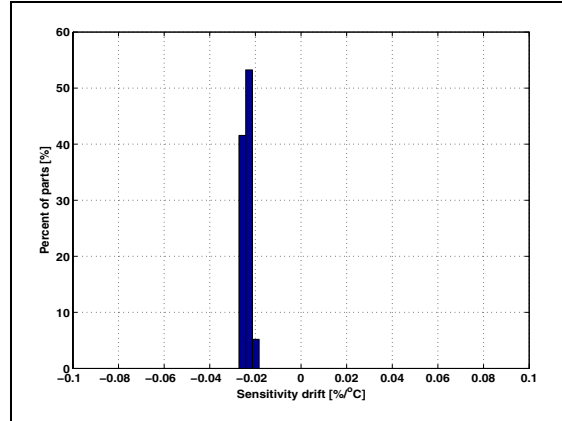

Figure 13. Y axis Zero-g level change vs. temperature at 3.3 V

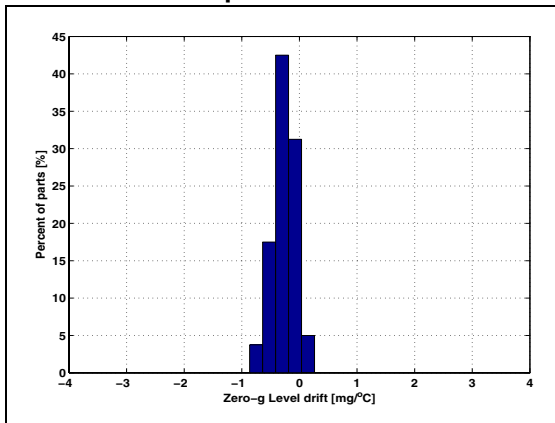

Figure 14. Y axis Sensitivity change vs. temperature at 3.3 V

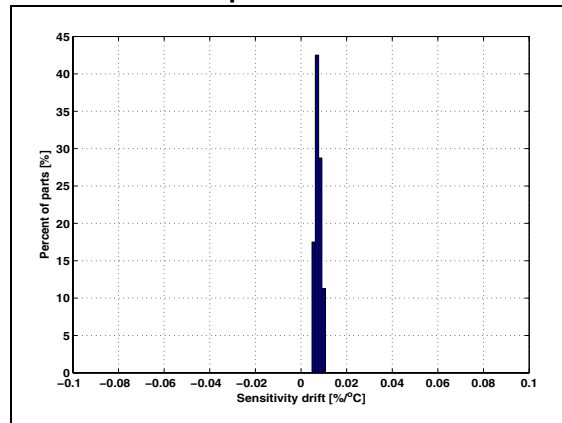

Figure 15. Z axis Zero-g level change vs. temperature at 3.3 V

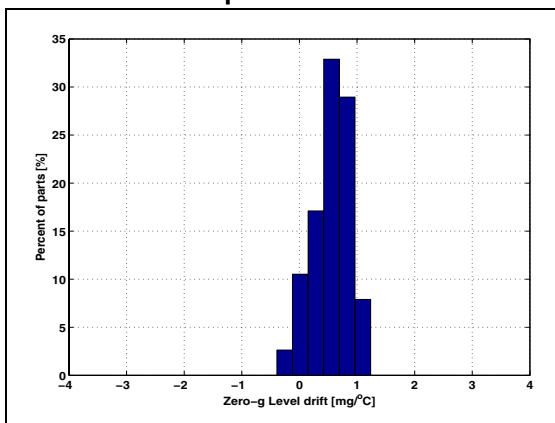
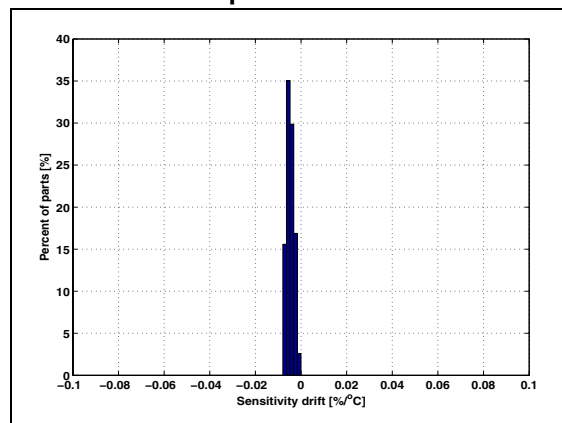

Figure 16. Z axis Sensitivity change vs. temperature at 3.3 V



### 5.3 Electrical characteristics at 25 °C

Figure 17. Current consumption in normal mode at 3.3 V

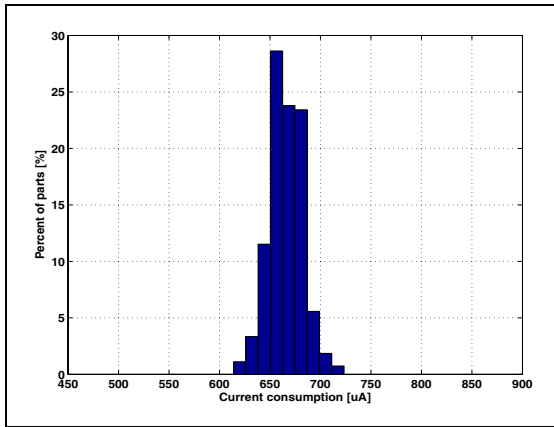

Figure 18. Current consumption in power-down at 3.3 V

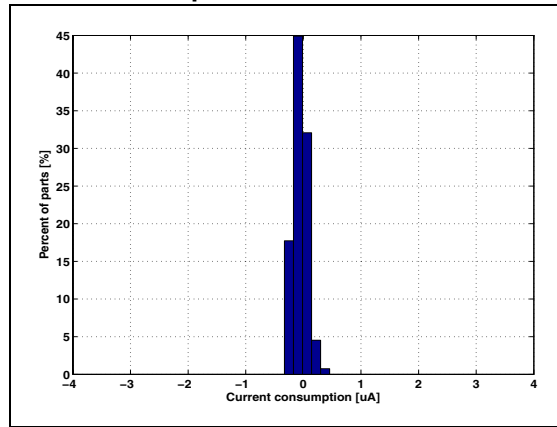

Figure 19. Noise density at 3.3 V (X, Y axis)

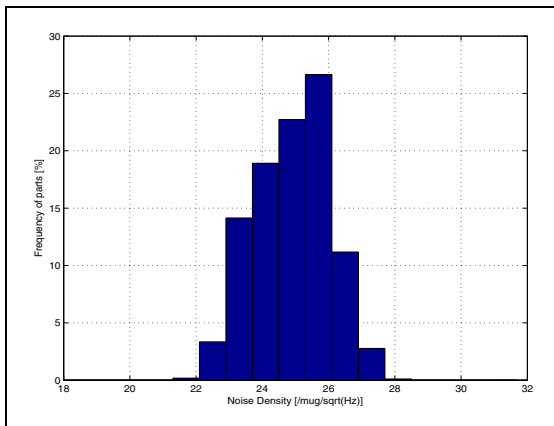
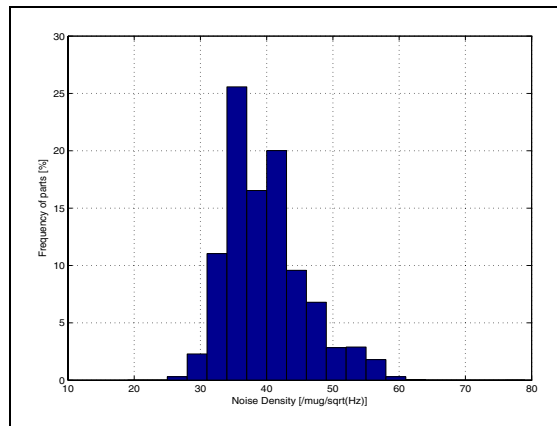

Figure 20. Noise density at 3.3 V (Z axis)





## 6 Package information

In order to meet environmental requirements, ST offers these devices in ECOPACK<sup>®</sup> packages. These packages have a lead-free second level interconnect. The category of second level Interconnect is marked on the inner box label, in compliance with JEDEC Standard JESD97. The maximum ratings related to soldering conditions are also marked on the inner box label. ECOPACK<sup>®</sup> is an ST trademark.

ECOPACK<sup>®</sup> specifications are available at: [www.st.com](http://www.st.com).

**Figure 21. LGA 16L: mechanical data and package dimensions**

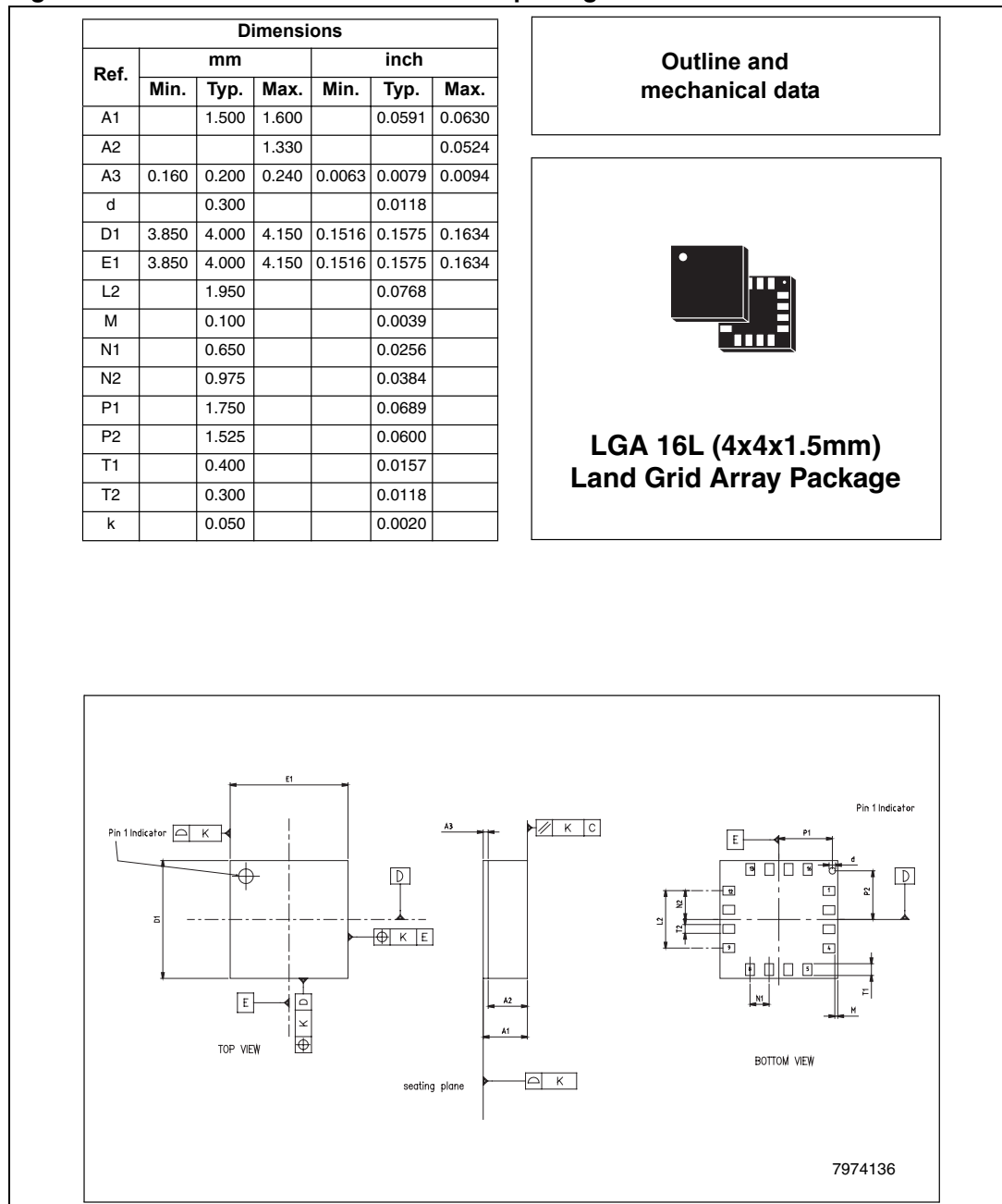

## 7 Revision history

**Table 7. Document revision history**

Date	Revision	Changes
15-Jan-2008	1	Initial release.
18-Feb-2008	2	Minor text changes
29-Apr-2008	3	Updated <i>Section 2: Mechanical and electrical specifications</i> and added distribution graphs in <i>Section 5: Typical performance characteristics</i>

**Please Read Carefully:**

Information in this document is provided solely in connection with ST products. STMicroelectronics NV and its subsidiaries ("ST") reserve the right to make changes, corrections, modifications or improvements, to this document, and the products and services described herein at any time, without notice.

All ST products are sold pursuant to ST's terms and conditions of sale.

Purchasers are solely responsible for the choice, selection and use of the ST products and services described herein, and ST assumes no liability whatsoever relating to the choice, selection or use of the ST products and services described herein.

No license, express or implied, by estoppel or otherwise, to any intellectual property rights is granted under this document. If any part of this document refers to any third party products or services it shall not be deemed a license grant by ST for the use of such third party products or services, or any intellectual property contained therein or considered as a warranty covering the use in any manner whatsoever of such third party products or services or any intellectual property contained therein.

**UNLESS OTHERWISE SET FORTH IN ST'S TERMS AND CONDITIONS OF SALE ST DISCLAIMS ANY EXPRESS OR IMPLIED WARRANTY WITH RESPECT TO THE USE AND/OR SALE OF ST PRODUCTS INCLUDING WITHOUT LIMITATION IMPLIED WARRANTIES OF MERCHANTABILITY, FITNESS FOR A PARTICULAR PURPOSE (AND THEIR EQUIVALENTS UNDER THE LAWS OF ANY JURISDICTION), OR INFRINGEMENT OF ANY PATENT, COPYRIGHT OR OTHER INTELLECTUAL PROPERTY RIGHT.**

**UNLESS EXPRESSLY APPROVED IN WRITING BY AN AUTHORIZED ST REPRESENTATIVE, ST PRODUCTS ARE NOT RECOMMENDED, AUTHORIZED OR WARRANTED FOR USE IN MILITARY, AIR CRAFT, SPACE, LIFE SAVING, OR LIFE SUSTAINING APPLICATIONS, NOR IN PRODUCTS OR SYSTEMS WHERE FAILURE OR MALFUNCTION MAY RESULT IN PERSONAL INJURY, DEATH, OR SEVERE PROPERTY OR ENVIRONMENTAL DAMAGE. ST PRODUCTS WHICH ARE NOT SPECIFIED AS "AUTOMOTIVE GRADE" MAY ONLY BE USED IN AUTOMOTIVE APPLICATIONS AT USER'S OWN RISK.**

Resale of ST products with provisions different from the statements and/or technical features set forth in this document shall immediately void any warranty granted by ST for the ST product or service described herein and shall not create or extend in any manner whatsoever, any liability of ST.

ST and the ST logo are trademarks or registered trademarks of ST in various countries.

Information in this document supersedes and replaces all information previously supplied.

The ST logo is a registered trademark of STMicroelectronics. All other names are the property of their respective owners.

© 2008 STMicroelectronics - All rights reserved

STMicroelectronics group of companies

Australia - Belgium - Brazil - Canada - China - Czech Republic - Finland - France - Germany - Hong Kong - India - Israel - Italy - Japan - Malaysia - Malta - Morocco - Singapore - Spain - Sweden - Switzerland - United Kingdom - United States of America

[www.st.com](http://www.st.com)

Компания «Life Electronics» занимается поставками электронных компонентов импортного и отечественного производства от производителей и со складов крупных дистрибьюторов Европы, Америки и Азии.

С конца 2013 года компания активно расширяет линейку поставок компонентов по направлению коаксиальный кабель, кварцевые генераторы и конденсаторы (керамические, пленочные, электролитические), за счёт заключения дистрибьюторских договоров

Мы предлагаем:

- Конкурентоспособные цены и скидки постоянным клиентам.
- Специальные условия для постоянных клиентов.
- Подбор аналогов.
- Поставку компонентов в любых объемах, удовлетворяющих вашим потребностям.
- Приемлемые сроки поставки, возможна ускоренная поставка.
- Доставку товара в любую точку России и стран СНГ.
- Комплексную поставку.
- Работу по проектам и поставку образцов.
- Формирование склада под заказчика.
- Сертификаты соответствия на поставляемую продукцию (по желанию клиента).
- Тестирование поставляемой продукции.
- Поставку компонентов, требующих военную и космическую приемку.
- Входной контроль качества.
- Наличие сертификата ISO.

В составе нашей компании организован Конструкторский отдел, призванный помогать разработчикам, и инженерам.

Конструкторский отдел помогает осуществить:

- Регистрацию проекта у производителя компонентов.
- Техническую поддержку проекта.
- Защиту от снятия компонента с производства.
- Оценку стоимости проекта по компонентам.
- Изготовление тестовой платы монтаж и пусконаладочные работы.



Тел: +7 (812) 336 43 04 (многоканальный)  
Email: org@lifeelectronics.ru