

### FEATURES

- 1 mm height profile**
- Compact PCB footprint**
- Seamless transition between modes**
- 38  $\mu$ A typical quiescent current**
- 2.5 MHz operation enables 1.5  $\mu$ H inductor**
- Input voltage: 2.3 V to 5.5 V**
- Fixed output voltage: 2.8 V to 5.0 V**
- Adjustable model output voltage range: 2.8 V to 5.5 V**
- 600 mA (ADP2503) and 1000 mA (ADP2504) output options**
- Boost converter configuration with load disconnect**
- SYNC pin with three different modes**
  - Power save mode (PSM) for improved light load efficiency**
  - Forced fixed frequency operation mode**
  - Synchronization with external clock**
- Internal compensation**
- Soft start**
- Enable/shutdown logic input**
- Overtemperature protection**
- Short-circuit protection**
- Undervoltage lockout protection**
- Small 10-lead 3 mm  $\times$  3 mm LFCSP (QFN) package**

### APPLICATIONS

- Wireless handsets**
- Digital cameras/portable audio players**
- Miniature hard disk power supplies**
- USB powered devices**

### GENERAL DESCRIPTION

The ADP2503/ADP2504 are high efficiency, low quiescent current step-up/step-down dc-to-dc converters that can operate at input voltages greater than, less than, or equal to the regulated output voltage. The power switches and synchronous rectifiers are internal to minimize external part count. At high load currents, the ADP2503/ADP2504 use a current-mode, fixed frequency pulse-width modulation (PWM) control scheme for optimal stability and transient response. To ensure the longest battery life in portable applications, the ADP2503/ADP2504 have an optional power save mode that reduces the switching frequency under light load conditions. For wireless and other low noise applications where variable frequency power save mode may cause interference, the logic control input sync forces fixed frequency PWM operation under all load conditions.

The ADP2503/ADP2504 can run from input voltages between 2.3 V and 5.5 V, allowing single lithium or lithium polymer cell, multiple alkaline or NiMH cells, PCMCIA, USB, and other standard power sources. The ADP2503/ADP2504 have fixed output options, or using the adjustable model, the output voltage can be programmed through an external resistor divider. Compensation is internal to minimize the number of external components.

During logic-controlled shutdown, the input is disconnected from the output and draws less than 1  $\mu$ A from the input source. Operating as boost converters, the ADP2503/ADP2504 feature a true load disconnect function that isolates the load from the power source. Other key features include undervoltage lockout to prevent deep battery discharge, and soft start to prevent input current overshoot at startup.

### TYPICAL APPLICATION CIRCUIT

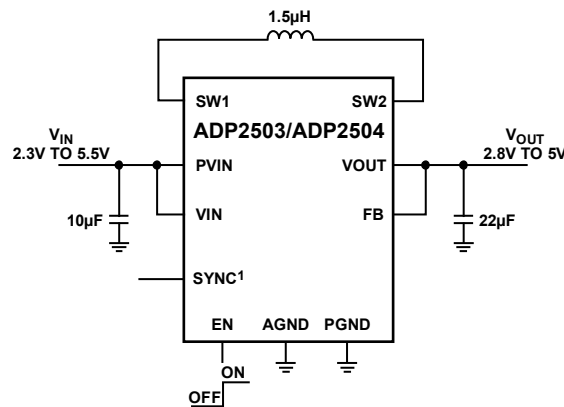

<sup>1</sup>ALLOWS THE ADP2503/ADP2504 TO OPERATE IN THREE DIFFERENT MODES.

Figure 1.

### Rev. B

Information furnished by Analog Devices is believed to be accurate and reliable. However, no responsibility is assumed by Analog Devices for its use, nor for any infringements of patents or other rights of third parties that may result from its use. Specifications subject to change without notice. No license is granted by implication or otherwise under any patent or patent rights of Analog Devices. Trademarks and registered trademarks are the property of their respective owners.

## TABLE OF CONTENTS

Features .....	1	Soft Start .....	11
Applications.....	1	SYNC Function.....	11
General Description .....	1	Enable.....	11
Typical Application Circuit .....	1	Undervoltage Lockout .....	12
Revision History .....	2	Thermal Shutdown .....	12
Specifications.....	3	Short-Circuit Protection.....	12
Absolute Maximum Ratings.....	4	Reverse Current Limit .....	12
Thermal Data .....	4	Applications Information .....	13
Thermal Resistance .....	4	Inductor Selection .....	13
ESD Caution.....	4	Output Voltage Programming.....	14
Pin Configuration and Function Descriptions.....	5	PCB Layout Guidelines.....	15
Typical Performance Characteristics .....	6	Outline Dimensions .....	16
Theory of Operation .....	11	Ordering Guide .....	16
Power Save Mode.....	11		

## REVISION HISTORY

<b>6/10—Rev. A to Rev. B</b>	
Changes to Ordering Guide .....	16
<b>8/09—Rev. 0 to Rev. A</b>	
Changes to Features Section, Figure 1, and General Description Section.....	1
Changes to Feedback Voltage Parameter and EN, SYNC Leakage Current Parameter, Table 1 .....	3
Changes to Table 2 and Thermal Resistance Section.....	4
Added Thermal Data Section .....	4
Changes to Figure 2 and Table 4.....	5
Changes to Figure 12.....	7
Changes to Figure 17.....	8
Changes to SYNC Function Section .....	11
Changes to Undervoltage Lockout Section.....	12
Changes to Table 6.....	13
Added Output Voltage Programming Section .....	14
Added Figure 30; Renumbered Sequentially .....	14
Changes to Ordering Guide .....	16
<b>10/08—Revision 0: Initial Version</b>	

## SPECIFICATIONS

$V_{IN} = 3.6\text{ V}$ ,  $V_{OUT} = 3.3\text{ V}$ , @  $T_A = T_J = -40^\circ\text{C}$  to  $+125^\circ\text{C}$  for minimum/maximum specifications and  $T_A = 25^\circ\text{C}$  for typical specifications, unless otherwise noted.<sup>1</sup>

**Table 1.**

Parameters	Conditions	Min	Typ	Max	Unit
<b>INPUT CHARACTERISTICS</b>					
Input Voltage Range		2.3		5.5	V
Undervoltage Lockout Threshold	$V_{IN}$ rising	2.15	2.20	2.25	V
	$V_{IN}$ falling	2.10	2.14	2.20	V
<b>OUTPUT CHARACTERISTICS</b>					
Output Voltage Range		2.8		5.5	V
Feedback Impedance			450		k $\Omega$
Feedback Voltage	ADP2503/ADP2504 adjustable output (PWM operation, no load)	490	500	510	mV
Output Voltage Initial Accuracy	ADP2503/ADP2504 fixed output (PWM operation, no load)	-2		+2	%
Load and Line Regulation	$V_{IN} = 2.3\text{ V}$ to $3.6\text{ V}$ , $I_{LOAD} = 0\text{ mA}$ to $500\text{ mA}$ , forced PWM mode			0.5	%
	$V_{IN} = 2.3\text{ V}$ to $5.5\text{ V}$ , $I_{LOAD} = 0\text{ mA}$ to $500\text{ mA}$ , forced PWM mode			0.6	%
<b>CURRENT CHARACTERISTICS</b>					
Quiescent Current ( $V_{IN}$ )	$I_{OUT} = 0\text{ mA}$ , $V_{IN} = EN = 3.6\text{ V}$ , device not switching		38	50	$\mu\text{A}$
Shutdown Current	$T_A = T_J = -40^\circ\text{C}$ to $+125^\circ\text{C}$		0.2	1	$\mu\text{A}$
<b>SWITCH CHARACTERISTICS</b>					
N-Channel Switches	$V_{IN} = 3.6\text{ V}$		150		m $\Omega$
P-Channel Switches	$V_{IN} = V_{OUT} = 3.6\text{ V}$		150		m $\Omega$
P-Channel Leakage	$T_J = -40^\circ\text{C}$ to $+125^\circ\text{C}$			1	$\mu\text{A}$
Switch Current Limit					
ADP2504		1.3		2.0	A
ADP2503		1.0		1.4	A
Reverse Current Limit				1.1	A
<b>OSCILLATOR AND STARTUP</b>					
Oscillator Frequency		2.1	2.5	2.9	MHz
On Time PMOS1 (Buck Mode)	Minimum duty cycle = 30%	130			ns
On Time NMOS2 (Boost Mode)	Maximum duty cycle = 50% ( $\times 2$ )			200	ns
SYNC Clock Frequency		2.2		2.8	MHz
SYNC Clock Minimum Off Time		160			ns
<b>LOGIC LEVEL CHARACTERISTICS</b>					
EN, SYNC Input High Threshold		1.2			V
EN, SYNC Input Low Threshold				0.4	V
EN, SYNC Leakage Current	$V_{EN} = V_{IN}$ , $V_{SYNC} = V_{IN}$	-1	+0.1	+1	$\mu\text{A}$
<b>THERMAL CHARACTERISTICS</b>					
Thermal Shutdown Threshold			150		$^\circ\text{C}$
Thermal Shutdown Hysteresis			25		$^\circ\text{C}$

<sup>1</sup> All limits at temperature extremes are guaranteed via correlation using standard statistical quality control (SQC).

## ABSOLUTE MAXIMUM RATINGS

Table 2.

Parameter	Rating
PVIN, VIN, SW1, SW2, VOUT, SYNC, EN, FB	−0.3 V to +6 V
PGND to AGND	−0.3 V to 0.3 V
Operating Ambient Temperature Range	−40°C to +125°C
Operating Junction Temperature Range	−40°C to +125°C
Storage Temperature Range	−65°C to +150°C
Soldering Conditions	JEDEC J-STD-020
ESD Human Body Model	±2000 V
ESD Charged Device Model	±1500 V
ESD Machine Model	±100 V

Stresses above those listed under Absolute Maximum Ratings may cause permanent damage to the device. This is a stress rating only; functional operation of the device at these or any other conditions above those indicated in the operational section of this specification is not implied. Exposure to absolute maximum rating conditions for extended periods may affect device reliability.

### THERMAL DATA

Absolute maximum ratings apply individually only, not in combination.

The ADP2503/ADP2504 can be damaged when the junction temperature limits are exceeded. Monitoring ambient temperature ( $T_A$ ) does not guarantee that the junction temperature ( $T_J$ ) is within the specified temperature limits. In applications with high power dissipation and poor thermal resistance, the maximum ambient temperature may have to be derated. In applications with moderate power dissipation and low PCB thermal resistance, the maximum ambient temperature can exceed the maximum limit as long as the junction temperature is within specification limits.  $T_J$  of the device is dependent on  $T_A$ , the power dissipation ( $P_D$ ) of the device, and the junction-to-ambient thermal resistance ( $\theta_{JA}$ ) of the package. Maximum  $T_J$  is calculated from  $T_A$  and  $P_D$  using the following formula:

$$T_J = T_A + (P_D \times \theta_{JA})$$

$\theta_{JA}$  of the package is based on modeling and calculation using a 4-layer board. The junction-to-ambient thermal resistance is highly dependent on the application and board layout. In applications where high maximum power dissipation exists, close attention to thermal board design is required. The value of  $\theta_{JA}$  may vary, depending on PCB material, layout, and environmental conditions. The specified values of  $\theta_{JA}$  are based on a 4-layer, 4 inch × 3 inch circuit board. Refer to JEDEC JESD 51-9 for detailed information on the board construction.

### THERMAL RESISTANCE

$\theta_{JA}$  are specified for the worst-case conditions, that is, a device soldered in a circuit board for surface-mount packages.

Table 3.

Package Type	$\theta_{JA}$	Unit
10-Lead LFCSP (QFN)	84	°C/W

### ESD CAUTION



**ESD (electrostatic discharge) sensitive device.** Charged devices and circuit boards can discharge without detection. Although this product features patented or proprietary protection circuitry, damage may occur on devices subjected to high energy ESD. Therefore, proper ESD precautions should be taken to avoid performance degradation or loss of functionality.

## PIN CONFIGURATION AND FUNCTION DESCRIPTIONS

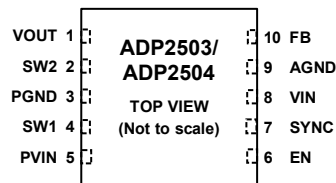

NOTES  
1. CONNECT EXPOSED PAD TO PGND.

Figure 2. Pin Configuration

07475-003

Table 4. Pin Function Descriptions

Pin No.	Mnemonic	Description
1	VOUT	Output of the ADP2503/ADP2504. Connect the output capacitor between VOUT and PGND.
2	SW2	Power Switch 2 Connection. This is the internal connection to the input PMOS and NMOS switches. Connect SW2 to the inductor with a short, wide track.
3	PGND	Power GND. Connect the input and output capacitors and the PGND pin to a PGND plane.
4	SW1	Power Switch 1 Connection. This is the internal connection to the output PMOS and NMOS switches. Connect SW1 to the inductor with a short, wide track.
5	PVIN	Power Input. This the input to the buck-boost power switches. Place a 10 $\mu$ F capacitor between PVIN and PGND as close as possible to the ADP2503/ADP2504.
6	EN	Enable. Drive EN high to turn on the ADP2503/ADP2504. Bring EN low to put the part into shutdown mode.
7	SYNC	The SYNC pin permits the ADP2503/ADP2504 to operate in three different modes. Normal operation: with SYNC driven low, the ADP2503/ADP2504 operate at 2.5 MHz PWM mode for heavy and medium loads, and moves to power save mode (PSM) mode for light loads. Forced PWM operation: with SYNC driven high, the ADP2503/ADP2504 operate at fixed 2.5 MHz PWM mode for all load conditions. SYNC mode: to synchronize the ADP2503/ADP2504 switching to an external signal, drive this pin with a clock between 2.2 MHz and 2.8 MHz. The SYNC signal must have on and off times greater than 160 ns.
8	VIN	Analog Power Supply. This is the supply for the ADP2503/ADP2504 internal circuitry.
9	AGND	Analog Ground.
10	FB	Output Feedback. This is an input to the internal error amplifier and must be connected to VOUT on fixed output versions; for the adjustable model, this is the voltage feedback.
EP	Exposed pad	Connect the exposed pad to PGND.

## TYPICAL PERFORMANCE CHARACTERISTICS

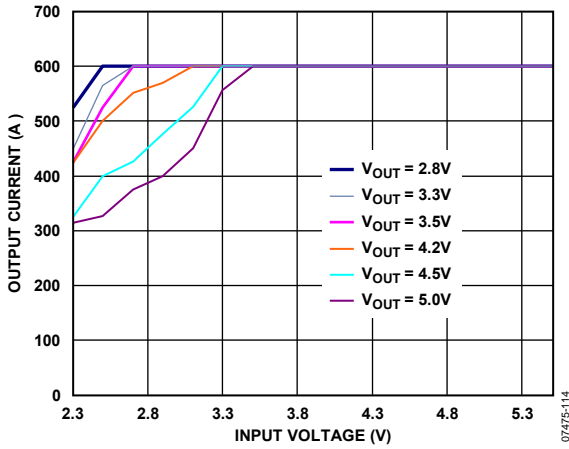

Figure 3. ADP2503 Output Current vs. Input Voltage

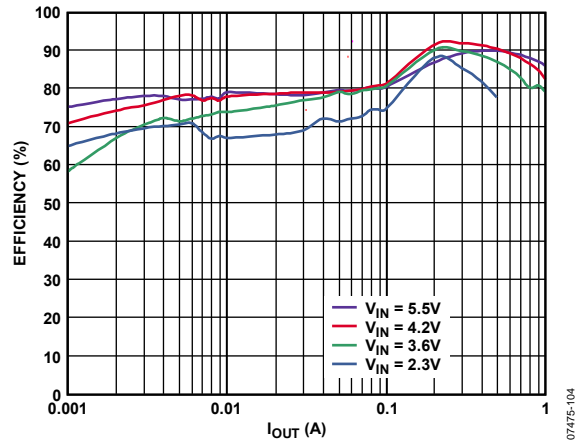

Figure 6. Efficiency vs. Output Current, PSM and PWM Mode ( $V_{OUT} = 5.0\text{ V}$ )

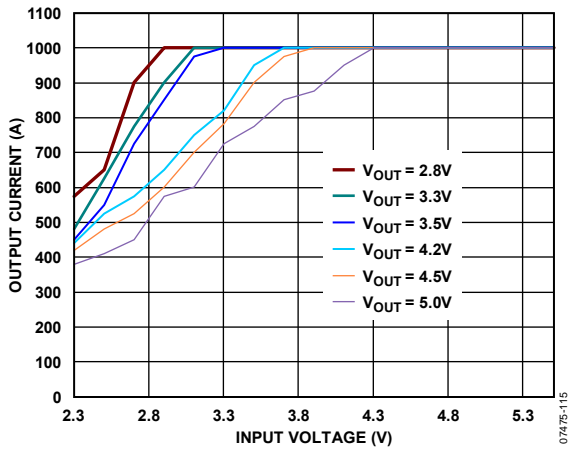

Figure 4. ADP2504 Output Current vs. Input Voltage

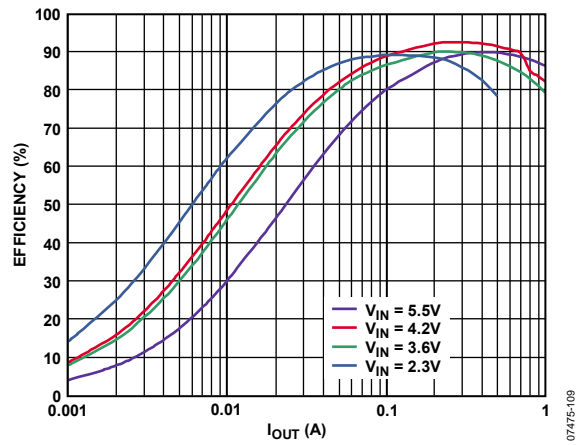

Figure 7. Efficiency vs. Output Current, PWM Mode ( $V_{OUT} = 3.3\text{ V}$ )

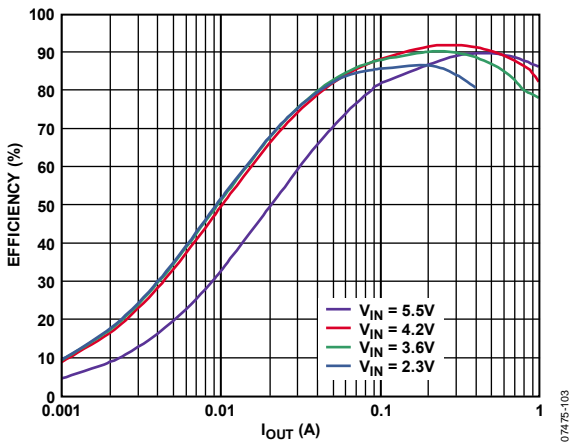

Figure 5. Efficiency vs. Output Current, PWM Mode ( $V_{OUT} = 5.0\text{ V}$ )

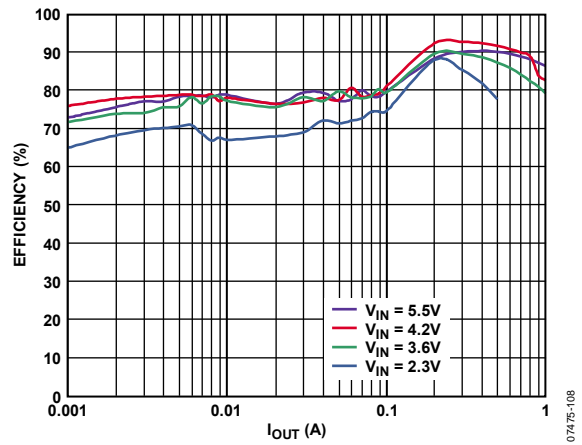

Figure 8. Efficiency vs. Output Current, PSM and PWM Mode ( $V_{OUT} = 3.3\text{ V}$ )

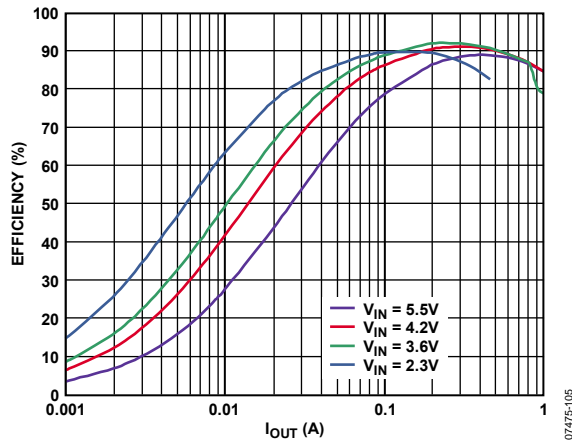

Figure 9. Efficiency vs. Output Current, PWM Mode ( $V_{OUT} = 2.8\text{ V}$ )

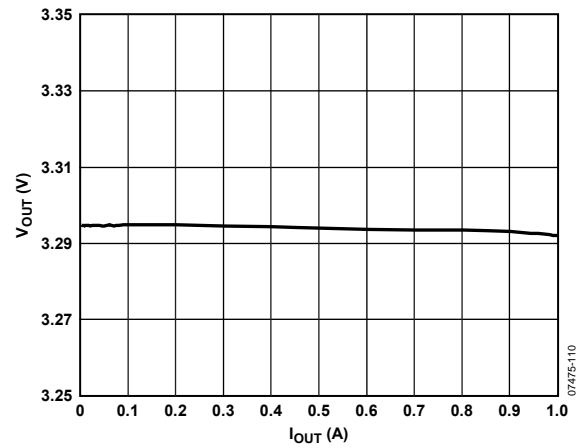

Figure 12. Load Regulation ( $V_{IN} = 3.6\text{ V}$ ,  $V_{OUT} = 3.3\text{ V}$ )

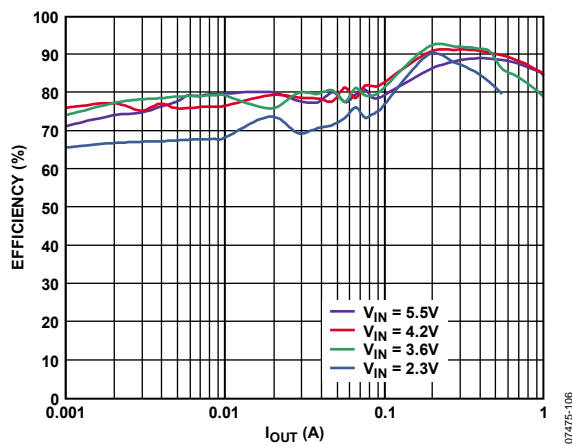

Figure 10. Efficiency vs. Output Current, PSM and PWM Mode ( $V_{OUT} = 2.8\text{ V}$ )

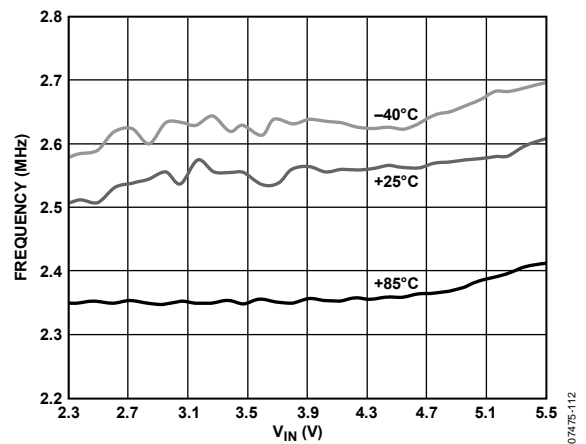

Figure 13. Frequency vs. Input Voltage Over Temperature ( $V_{OUT} = 3.3\text{ V}$ )

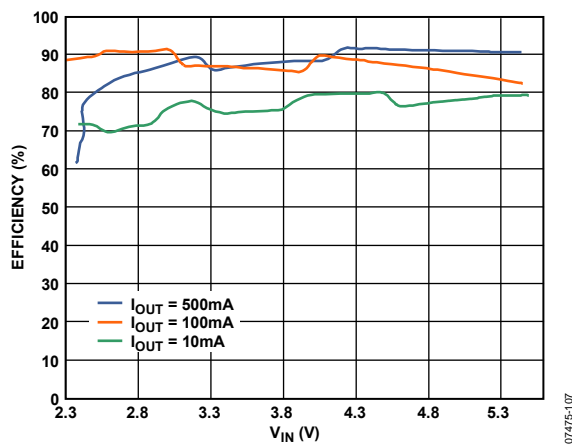

Figure 11. Efficiency vs. Input Voltage ( $V_{OUT} = 3.3\text{ V}$ )

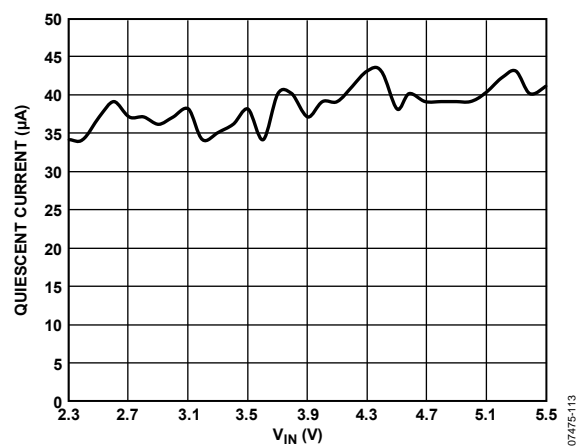

Figure 14. Quiescent Current vs. Input Voltage ( $V_{OUT} = 3.3\text{ V}$ )

# ADP2503/ADP2504

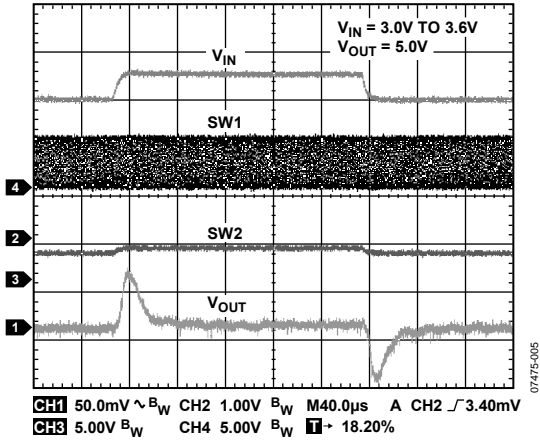

Figure 15. Line Transient, PWM Mode ( $V_{IN} = 3.0V$  to  $3.6V$ ,  $V_{OUT} = 5.0V$ )

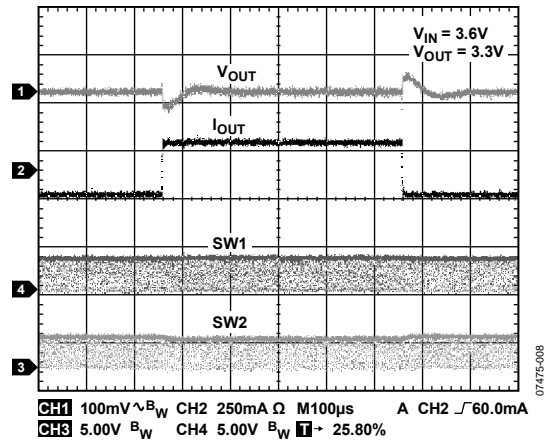

Figure 18. Load Transient ( $V_{IN} = 3.6V$ ,  $V_{OUT} = 3.3V$ ,  $I_{OUT} = 100mA$  to  $350mA$ )

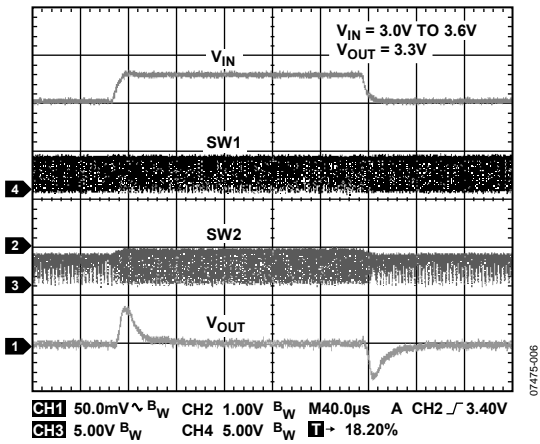

Figure 16. Line Transient, PWM Mode ( $V_{IN} = 3.0V$  to  $3.6V$ ,  $V_{OUT} = 3.3V$ )

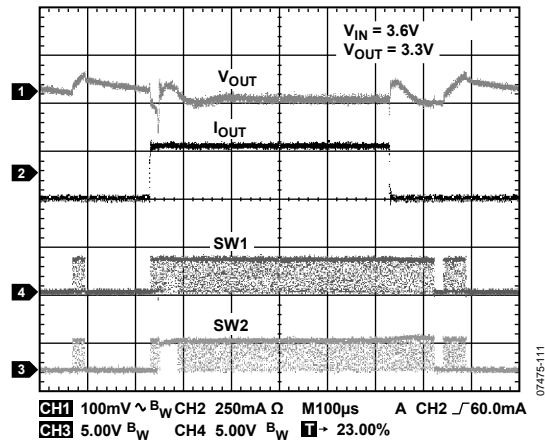

Figure 19. Load Transient ( $V_{IN} = 3.6V$ ,  $V_{OUT} = 3.3V$ ,  $I_{OUT} = 10mA$  to  $300mA$ )

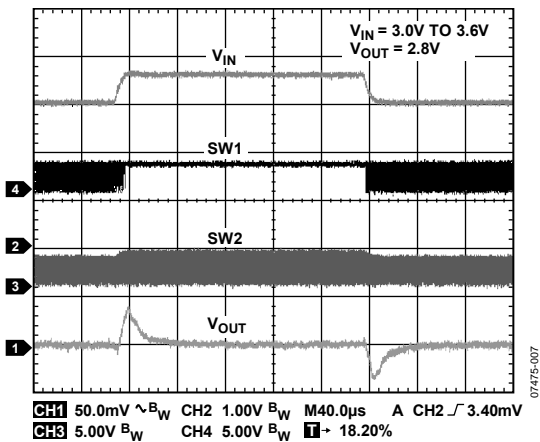

Figure 17. Line Transient, PWM Mode ( $V_{IN} = 3.0V$  to  $3.6V$ ,  $V_{OUT} = 2.8V$ )

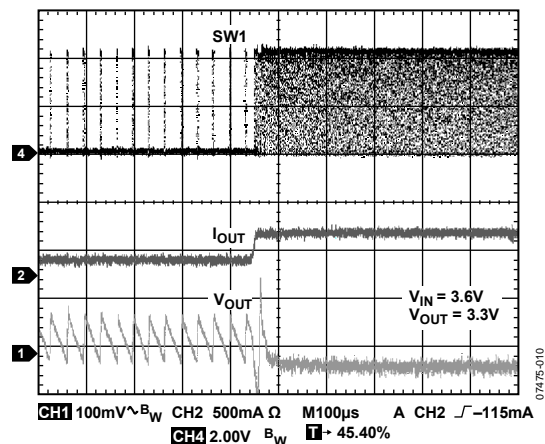

Figure 20. Mode Change by Load Transients, Load Rise ( $V_{IN} = 3.6V$ ,  $V_{OUT} = 3.3V$ )



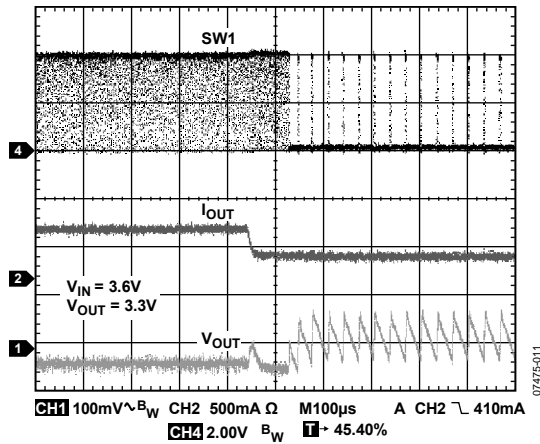

Figure 21. Mode Change by Load Transients, Load Fall (V<sub>OUT</sub> = 3.3 V)

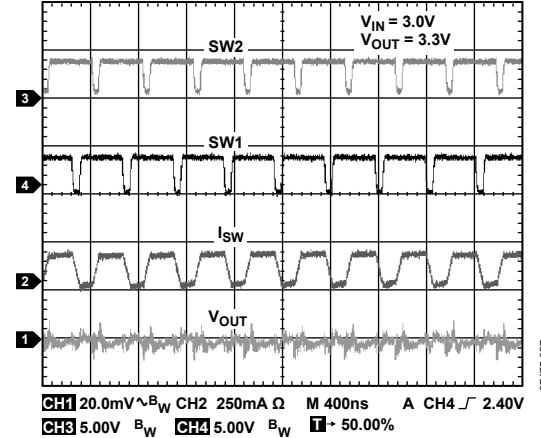

Figure 24. Typical PWM Switching Waveform, Buck-Boost Operation (V<sub>OUT</sub> = 3.3 V)

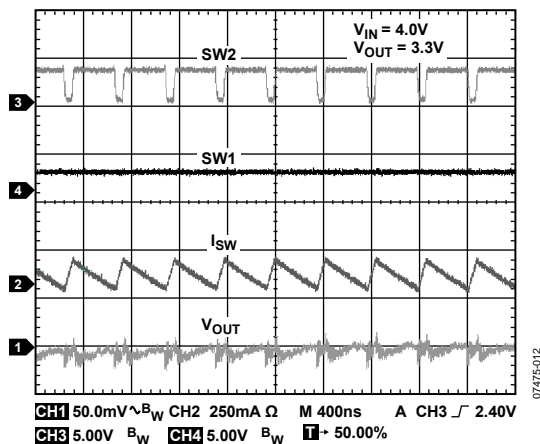

Figure 22. Typical PWM Switching Waveform, Buck Operation (V<sub>OUT</sub> = 3.3 V)

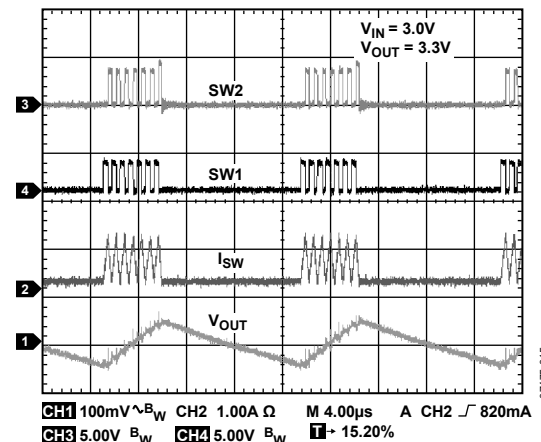

Figure 25. Typical PSM Switching Waveform, Buck-Boost Operation (V<sub>OUT</sub> = 3.3 V)

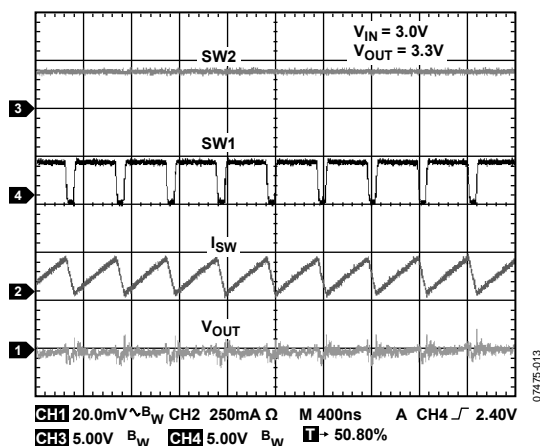

Figure 23. Typical PWM Switching Waveform, Boost Operation (V<sub>OUT</sub> = 3.3 V)

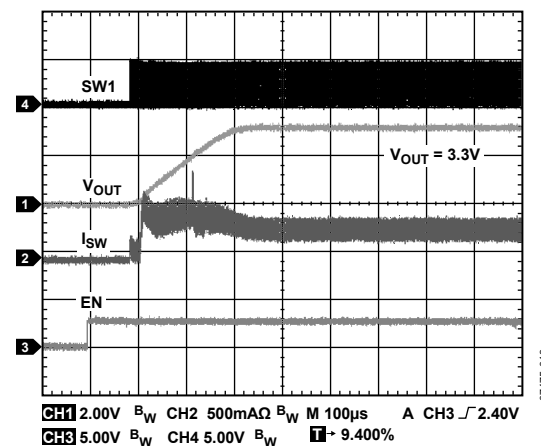

Figure 26. Startup into PWM Mode (V<sub>OUT</sub> = 3.3 V, I<sub>OUT</sub> = 300 mA)

# ADP2503/ADP2504

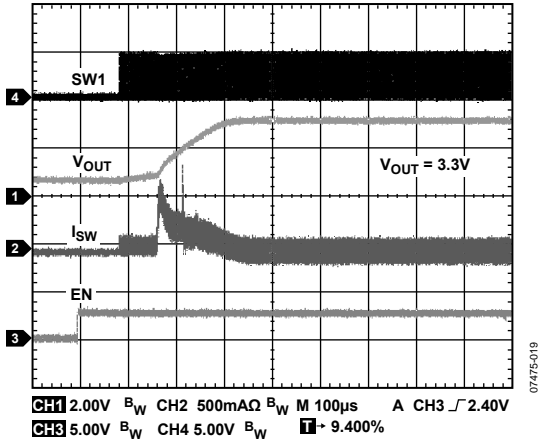

Figure 27. Startup into PWM Mode ( $V_{OUT} = 3.3\text{ V}$ ,  $I_{OUT} = 10\text{ mA}$ )

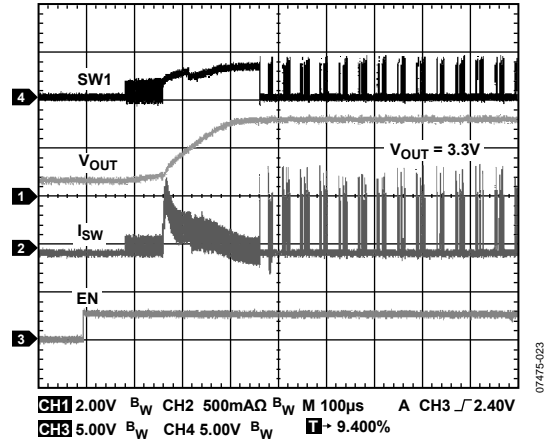

Figure 28. Startup into PSM Mode ( $V_{OUT} = 3.3\text{ V}$ ,  $I_{OUT} = 10\text{ mA}$ )

## THEORY OF OPERATION

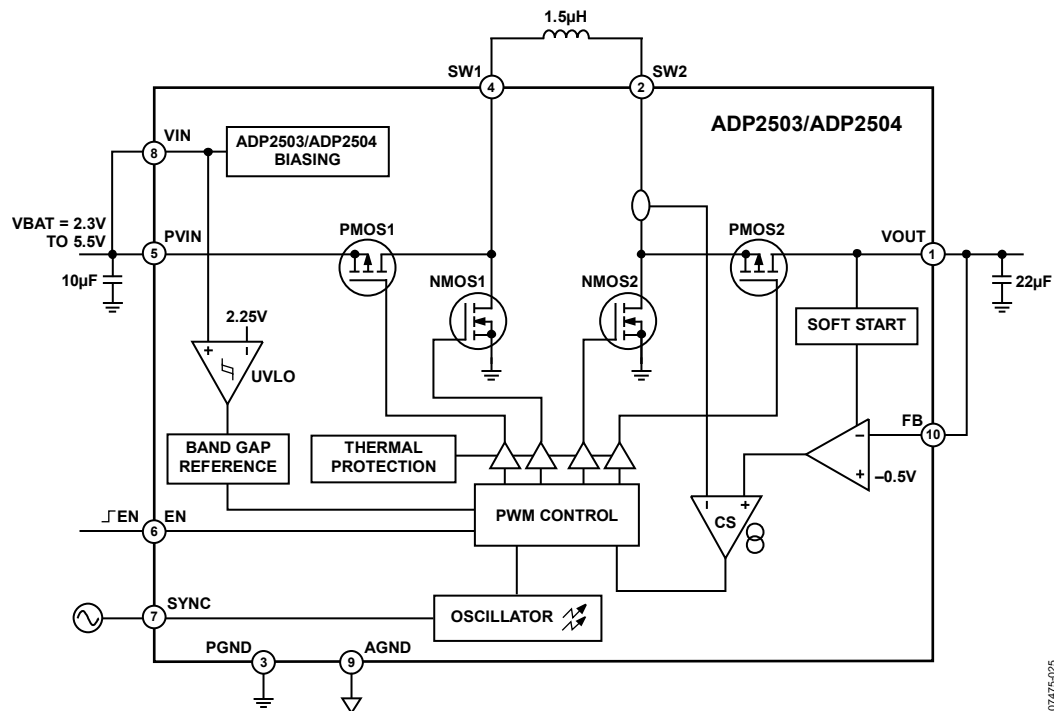

Figure 29. ADP2503/ADP2504 Block Diagram

07475-025

The ADP2503/ADP2504 are synchronous average current-mode switching buck-boost regulators designed to maintain a fixed output voltage  $V_{OUT}$  from an input supply  $V_{IN}$  that can be greater than, equal to, or less than  $V_{OUT}$ . When  $V_{IN}$  is significantly greater than  $V_{OUT}$ , the device is in buck mode: PMOS2 is always active, NMOS2 is always off, and the PMOS1 and NMOS1 switches constitute a buck converter. When  $V_{IN}$  is significantly lower than  $V_{OUT}$ , the device is in boost mode: PMOS1 is always active, NMOS1 is always off, and the NMOS2 and PMOS2 switches constitute a boost converter. When  $V_{IN}$  is in the range  $[V_{OUT} \pm 10\%]$ , the ADP2503/ADP2504 automatically enter the buck-boost mode. In buck-boost mode, the two operations, buck (PMOS1 and NMOS1 switching in antiphase) and boost (NMOS2 and PMOS2 switching in antiphase), take place at each period of the clock. This is aimed at maintaining the regulation and keeping a minimal current ripple in the inductor to guarantee good transient performances.

### POWER SAVE MODE

When the SYNC pin is low, the ADP2503/ADP2504 can operate in power save mode (PSM). In this mode, when the load current becomes less than 75 mA nominally at  $V_{IN} = 3.6$  V, the controller pulls up  $V_{OUT}$  and then halts the switching regime until  $V_{OUT}$  goes back to a restart value. Then  $V_{OUT}$  is pulled up again for a new cycle. This minimizes the switching losses at light load. When the load rises above 150 mA, the ADP2503/ADP2504 revert to fixed PWM mode. This results in about 75 mA of hysteresis

between PSM and fixed PWM, preventing oscillations between these two modes.

### SOFT START

When the ADP2503/ADP2504 are started,  $V_{OUT}$  is ramped from 0 V to its final programmed value in 200  $\mu$ s (typical). This limits the inrush current to less than 600 mA for a nominal output capacitor of 20  $\mu$ F. Because the  $V_{OUT}$  start-up slope is constant, the inrush current becomes larger if the output capacitor is made larger.

### SYNC FUNCTION

When the SYNC pin is high, PSM is deactivated. The ADP2503/ADP2504 always operate in PWM using the internal oscillator. When the SYNC pin is switching in the 2.1 MHz to 2.9 MHz range, the regulator switching frequency slides to the frequency applied on SYNC and then locks on it. When the SYNC pin stops switching, the regulator switching frequency slides back to the internal oscillator frequency.

### ENABLE

The device starts operation with soft start when the EN pin is brought high. Pulling the EN pin low forces the device into shutdown, with a typical shutdown current of 0.2  $\mu$ A.

In this mode, the PMOS power switches are turned off, the NMOS power switches are turned on, and the control circuitry is not enabled. For proper operation, the EN pin must be terminated and must not be left floating.

# ADP2503/ADP2504

## UNDERVOLTAGE LOCKOUT

The undervoltage lockout circuit prevents the device from operating incorrectly at low input voltages. It prevents the converter from turning on the power switches under undefined conditions and, therefore, prevents deep discharge of the battery supply.

$V_{IN}$  must be greater than 2.25 V to enable the converter. During operation, if  $V_{IN}$  drops below 2.10 V, the ADP2503/ADP2504 are disabled until the supply exceeds the UVLO rising threshold.

## THERMAL SHUTDOWN

When the junction temperature,  $T_j$ , exceeds 150°C typical, the device goes into thermal shutdown. In this mode, the power switches are turned off. The device resumes operation when the junction temperature again falls below 125°C typical.

## SHORT-CIRCUIT PROTECTION

When the nominal inductor peak current value of 1.5 A is reached, the ADP2503/ADP2504 first switch off the NMOS2 transistor if it is active. If the current thereafter continues to increase by an extra amount of 200 mA, the PMOS1 transistor is also switched off. This operation is reversible when the short circuit stops. It allows the inductor current ripple to be minimized close to 1.5 A and, thus, the controller to restore  $V_{OUT}$  even if a high load current is maintained after the short circuit.

## REVERSE CURRENT LIMIT

In case of a short circuit on  $V_{OUT}$  to a value greater than expected, the inductor current becomes negative (reverse current). The negative peak value is limited to 1.1 A by deactivating the PMOS2 switch.

## APPLICATIONS INFORMATION

### INDUCTOR SELECTION

The high 2.5 MHz switching frequency of the ADP2503/ADP2504 allows for minimal output voltage ripple, while minimizing inductor size and cost. Careful inductor selection also optimizes efficiency and reduces electromagnetic interference (EMI). The selection of the inductor value determines the inductor current ripple and loop dynamics.

$$\Delta I_{L, peak} (Buck) = \frac{V_{OUT} \times (V_{IN} - V_{OUT})}{V_{IN} \times f_{OSC} \times L}$$

$$\Delta I_{L, peak} (Boost) = \frac{(V_{OUT} - V_{IN})}{V_{OUT}} \times \frac{V_{IN}}{f_{OSC} \times L}$$

where:

$f_{OSC}$  is the switching frequency (typically 2.5 MHz).

$L$  is the inductor value in henries.

A larger inductor value reduces the current ripple (and, therefore, the peak inductor current), but is physically larger in size with increased dc resistance. Inductor values between 1  $\mu$ H and 1.5  $\mu$ H are suggested. The maximum inductor value to ensure stability is 2.0  $\mu$ H. For increased efficiency with the ADP2504, it is suggested that a 1.5  $\mu$ H inductor be used.

The inductor peak current is at the maximum in boost mode. To determine the actual maximum inductor current in boost mode, the input dc current should be estimated.

$$I_{IN(MAX)} = I_{LOAD(MAX)} \times \left( \frac{V_{OUT}}{V_{IN}} \right) \times \frac{1}{\eta}$$

where  $\eta$  is efficiency (assume  $\eta \approx 0.85$  to 0.90).

The saturation current rating of the inductor must be at least  $I_{IN(MAX)} + \Delta I_{LOAD}/2$ .

Ceramic multilayer inductors can be used with lower current designs for a reduced overall solution size and dc resistance (DCR). These are available in low profile packages. Care must be taken because these derate quickly as the inductor value is increased, especially at higher operating temperatures.

Ferrite core inductors have good core loss characteristics as well as reasonable dc resistance. A shielded ferrite inductor reduces the EMI generated by the inductor.

**Table 6. Recommended Output Capacitors**

Vendor	Value	Part No.	Dimensions L x W x H (mm)
Murata	2 x 10 $\mu$ F, 6.3 V	GRM188R60J106ME47	1.6 x 0.8 x 0.8 (2)
TDK	2 x 10 $\mu$ F, 6.3 V	C1608JB0J106K	1.6 x 0.8 x 0.8 (2)
Murata	22 $\mu$ F, 6.3 V	GRM21BR60J226ME39	2 x 1.25 x 1.25
TDK	22 $\mu$ F, 6.3 V	C2012X5R0J226M	2 x 1.25 x 1.25
TDK	22 $\mu$ F, 10 V	C3216X5R1A226K	2 x 1.25 x 1.25
Murata	2 x 10 $\mu$ F, 10 V	GRM21BR71A106KE51L	2 x 1.25 x 1.25 (2)

**Table 5. Sample of Recommended Inductors**

Vendor	Value ( $\mu$ H)	Part No.	DCR (m $\Omega$ )	I <sub>SAT</sub> (A)	Dimensions L x W x H (mm)
Toko	1.2	DE2810C	55	1.7	2.8 x 2.8 x 1.0
Toko	1.5	DE2810C	60	1.5	2.8 x 2.8 x 1.0
Toko	1	MDT2520-CN	100	1.8	2.5 x 2 x 1.2
Murata	1	LQM2HP-G0	55	1.6	2.5 x 2 x 1
Murata	1.5	LQM2HP-G0	70	1.5	2.5 x 2 x 1
TDK	1.0	CPL2512T	90	1.5	2.5 x 1.5 x 1.2
TDK	1.5	CPL2512T	120	1.2	2.5 x 1.5 x 1.2
Coilcraft	1.0	LPS3010	85	1.7	3.0 x 3.0 x 0.9
Coilcraft	1.5	LPS3010	120	1.3	3.0 x 3.0 x 0.9
Taiyo	1.5	NR3015T1	40	1.5	3.0 x 3.0 x 1.5
Yuden					

### Output Capacitor Selection

The output capacitor selection determines the output voltage ripple, transient response, and the loop dynamics of the ADP2503/ADP2504. The output voltage ripple for a given output capacitor is as follows:

$$\Delta V_{OUT, peak} (Buck) = \frac{V_{OUT} \times (V_{IN} - V_{OUT})}{V_{IN} \times 8 \times L \times (f_{OSC})^2 \times C_{OUT}}$$

$$\Delta V_{OUT, peak} (Boost) = \frac{I_{LOAD} \times (V_{OUT} - V_{IN})}{C_{OUT} \times V_{OUT} \times f_{OSC}}$$

If the ADP2503/ADP2504 are operating in buck mode, the worst-case voltage ripple occurs for the highest input voltage,  $V_{IN}$ . If the ADP2503/ADP2504 are operating in boost mode, the worst-case voltage ripple occurs for the lowest input voltage,  $V_{IN}$ .

The maximum voltage overshoot, or undershoot, is inversely proportional to the value of the output capacitor. To ensure stability and excellent transient response, it is recommended to use a minimum of 22  $\mu$ F X5R 6.3 V or 2 x 10  $\mu$ F X5R 6.3 V capacitors at the output. The effective capacitance (includes temperature and dc bias effects) needed for stability is 14  $\mu$ F.

# ADP2503/ADP2504

## Input Capacitor Selection

The ADP2503/ADP2504 require an input capacitor to filter noise on the VIN pin, and provide the transient currents while maintaining constant input and output voltage. A 10 μF X5R/X7R ceramic capacitor rated for 6.3 V is the minimum recommended input capacitor. Increased input capacitance reduces the amplitude of the switching frequency ripple on the battery. Because of the dc bias characteristics of ceramic capacitors, a 0603, 6.3 V, X5R/X7R, 10 μF ceramic capacitor is preferable.

Table 7. Recommended Input Capacitors

Vendor	Value	Part No.	Dimensions L × W × H (mm)
Murata	10 μF, 6.3 V	GRM188R60J106ME47	1.6 × 0.8 × 0.8
TDK	10 μF, 6.3 V	C1608JB0J106K	1.6 × 0.8 × 0.8

## OUTPUT VOLTAGE PROGRAMMING

The ADP2503/ADP2504 have an adjustable model where the output is programmed through an external resistor divider. The resistor divider is connected between VOUT and FB and between FB and GND, and the combined total for the resistor divider should be kept close to 400 kΩ. The typical voltage reference ( $V_{REF}$ ) is 500 mV and depending on the output voltage required, the following equation can be used to calculate the value of the resistors:

$$V_{OUT} = \left( \frac{R1 + R2}{R2} \right) \times V_{REF}$$

An example of the calculation for a required output voltage of 3.0 V follows.

$$3.0 \text{ V} = \left( \frac{360 \text{ k}\Omega}{60 \text{ k}\Omega} \right) \times 0.5 \text{ V}$$

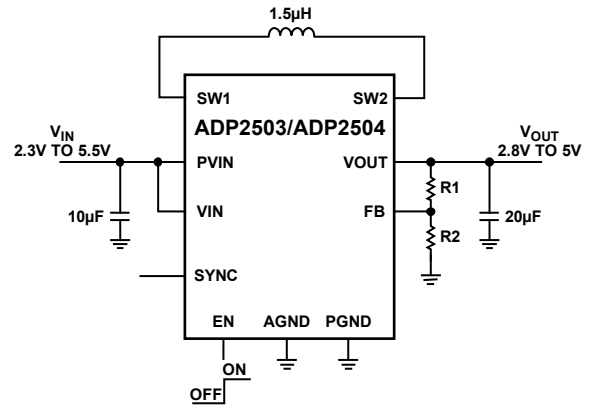

Figure 30. Typical Application Circuit for the Adjustable ADP2503/ADP2504

07475-01

## PCB LAYOUT GUIDELINES

Poor layout can affect ADP2503/ADP2504 performance, causing electromagnetic interference (EMI) and electromagnetic compatibility (EMC) performance, ground bounce, and voltage losses. Poor layout can also affect regulation and stability. A good layout is implemented using the following rules:

- Place the inductor, input capacitor, and output capacitor close to the IC using short tracks. These components carry high switching frequencies and large tracks act like antennas.
- Route the output voltage path away from the inductor and SW node to minimize noise and magnetic interference.
- Maximize the size of ground metal on the component side to help with thermal dissipation.
- Use a ground plane with several vias connecting to the component side ground to further reduce noise interference on sensitive circuit nodes.

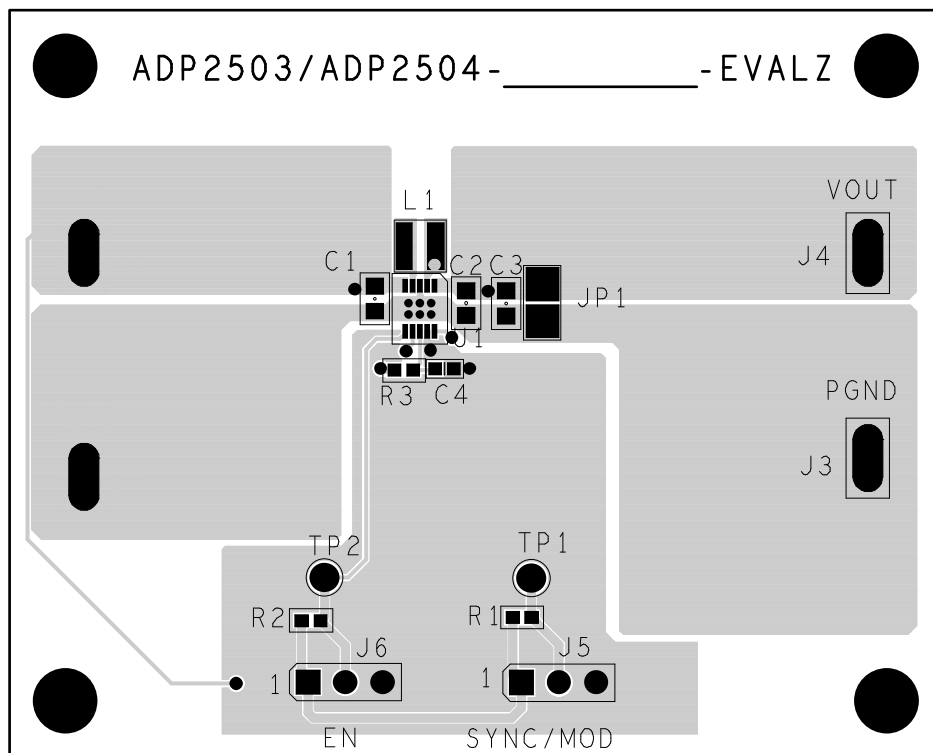
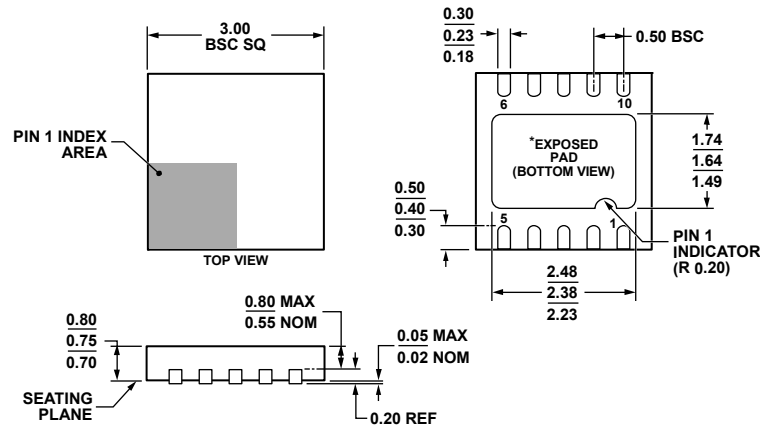

Figure 31. ADP2503/ADP2504 Evaluation Board for Fixed Output Voltages

# ADP2503/ADP2504

## OUTLINE DIMENSIONS



\*FOR PROPER CONNECTION OF THE EXPOSED PAD PLEASE REFER TO THE PIN CONFIGURATION AND FUNCTION DESCRIPTIONS SECTION OF THIS DATA SHEET.

Figure 32. 10-Lead Lead Frame Chip Scale Package [LFCSP\_WD]  
3 mm × 3 mm Body, Very Very Thin, Dual Lead  
(CP-10-9)  
Dimensions shown in millimeters

031208-B

## ORDERING GUIDE

Model <sup>1</sup>	Voltage	Max Current	Temperature Range	Package Description	Package Option	Branding
ADP2503ACPZ-2.8-R7	2.8 V	0.6 A	-40°C to +125°C	10-Lead Lead Frame Chip Scale Package [LFCSP_WD]	CP-10-9	L9Y
ADP2503ACPZ-3.3-R7	3.3 V	0.6 A	-40°C to +125°C	10-Lead Lead Frame Chip Scale Package [LFCSP_WD]	CP-10-9	L9Z
ADP2503ACPZ-3.5-R7	3.5 V	0.6 A	-40°C to +125°C	10-Lead Lead Frame Chip Scale Package [LFCSP_WD]	CP-10-9	LAP
ADP2503ACPZ-4.2-R7	4.2 V	0.6 A	-40°C to +125°C	10-Lead Lead Frame Chip Scale Package [LFCSP_WD]	CP-10-9	LA0
ADP2503ACPZ-4.5-R7	4.5 V	0.6 A	-40°C to +125°C	10-Lead Lead Frame Chip Scale Package [LFCSP_WD]	CP-10-9	LA1
ADP2503ACPZ-5.0-R7	5.0 V	0.6 A	-40°C to +125°C	10-Lead Lead Frame Chip Scale Package [LFCSP_WD]	CP-10-9	LA2
ADP2503ACPZ-R7	Adj	0.6 A	-40°C to +125°C	10-Lead Lead Frame Chip Scale Package [LFCSP_WD]	CP-10-9	LE7
ADP2504ACPZ-2.8-R7	2.8 V	1 A	-40°C to +125°C	10-Lead Lead Frame Chip Scale Package [LFCSP_WD]	CP-10-9	L9T
ADP2504ACPZ-3.3-R7	3.3 V	1 A	-40°C to +125°C	10-Lead Lead Frame Chip Scale Package [LFCSP_WD]	CP-10-9	L85
ADP2504ACPZ-3.5-R7	3.5 V	1 A	-40°C to +125°C	10-Lead Lead Frame Chip Scale Package [LFCSP_WD]	CP-10-9	LAN
ADP2504ACPZ-4.2-R7	4.2 V	1 A	-40°C to +125°C	10-Lead Lead Frame Chip Scale Package [LFCSP_WD]	CP-10-9	L9U
ADP2504ACPZ-4.5-R7	4.5 V	1 A	-40°C to +125°C	10-Lead Lead Frame Chip Scale Package [LFCSP_WD]	CP-10-9	L9V
ADP2504ACPZ-5.0-R7	5.0 V	1 A	-40°C to +125°C	10-Lead Lead Frame Chip Scale Package [LFCSP_WD]	CP-10-9	L9W
ADP2504ACPZ-R7	Adj	1 A	-40°C to +125°C	10-Lead Lead Frame Chip Scale Package [LFCSP_WD]	CP-10-9	LE8
ADP2503CPZ-REDYKIT <sup>2</sup>				Evaluation Board for Fixed Output Voltages, 3.3 V and 5.0 V		
ADP2504CPZ-REDYKIT <sup>2</sup>				Evaluation Board for Fixed Output Voltages, 2.8 V and 5.0 V		

<sup>1</sup> Z = RoHS Compliant Part.

<sup>2</sup> Redykit contains two evaluation boards with the stated output voltages plus three devices of each available fixed output voltage.



Компания «Life Electronics» занимается поставками электронных компонентов импортного и отечественного производства от производителей и со складов крупных дистрибьюторов Европы, Америки и Азии.

С конца 2013 года компания активно расширяет линейку поставок компонентов по направлению коаксиальный кабель, кварцевые генераторы и конденсаторы (керамические, пленочные, электролитические), за счёт заключения дистрибьюторских договоров

Мы предлагаем:

- Конкурентоспособные цены и скидки постоянным клиентам.
- Специальные условия для постоянных клиентов.
- Подбор аналогов.
- Поставку компонентов в любых объемах, удовлетворяющих вашим потребностям.
- Приемлемые сроки поставки, возможна ускоренная поставка.
- Доставку товара в любую точку России и стран СНГ.
- Комплексную поставку.
- Работу по проектам и поставку образцов.
- Формирование склада под заказчика.
- Сертификаты соответствия на поставляемую продукцию (по желанию клиента).
- Тестирование поставляемой продукции.
- Поставку компонентов, требующих военную и космическую приемку.
- Входной контроль качества.
- Наличие сертификата ISO.

В составе нашей компании организован Конструкторский отдел, призванный помогать разработчикам, и инженерам.

Конструкторский отдел помогает осуществить:

- Регистрацию проекта у производителя компонентов.
- Техническую поддержку проекта.
- Защиту от снятия компонента с производства.
- Оценку стоимости проекта по компонентам.
- Изготовление тестовой платы монтаж и пусконаладочные работы.



Тел: +7 (812) 336 43 04 (многоканальный)

Email: [org@lifeelectronics.ru](mailto:org@lifeelectronics.ru)