

ISL8488E, ISL8489E, ISL8490E, ISL8491E

±15kV ESD Protected, 5V, Low Power, High Speed and Slew Rate Limited, Full Duplex, RS-485/RS-422 Transceivers

FN6073
Rev.4.00
July 26, 2007

The ISL8488E, ISL8489E, ISL8490E, ISL8491E devices are ESD protected, BiCMOS, 5V powered, single transceivers that meet both the RS-485 and RS-422 standards for balanced communication. Each driver output and receiver input is protected against ±15kV ESD strikes, without latch-up. Unlike competitive versions, these Intersil devices are specified for 10% tolerance supplies (4.5V to 5.5V).

These devices are configured for full duplex (separate Rx input and Tx output pins) applications, so they are ideal for RS-422 networks requiring high ESD tolerance on the bus pins. The ISL8488E, ISL8490E are 8 Ld versions without Rx and Tx output enables. The other two versions include Rx and Tx output enable pins in a standard 14 Ld pinout.

The ISL8488E, ISL8489E utilize slew rate limited drivers which reduce EMI, and minimize reflections from improperly terminated transmission lines, or unterminated stubs in multidrop and multipoint applications.

Data rates up to 10Mbps are achievable by using the ISL8490E, ISL8491E, which feature higher slew rates.

The devices present a "single unit load" to the RS-485 bus, which allows a total of 32 transmitters and receivers on the network. For "1/8 unit load" versions (256 devices on the bus), please refer to the ISL4489E, ISL4491E data sheet.

Receiver (Rx) inputs feature a "fail-safe if open" design, which ensures a logic high Rx output if Rx inputs are floating.

Driver (Tx) outputs are short circuit protected, even for voltages exceeding the power supply voltage. Additionally, on-chip thermal shutdown circuitry disables the Tx outputs to prevent damage if power dissipation becomes excessive.

Features

- RS-485 I/O Pin ESD Protection ±15kV HBM
 - Class 3 ESD Level on all Other Pins >7kV HBM
- High Data Rates (ISL8490E, ISL8491E) . . . up to 10Mbps
- Slew Rate Limited for Error Free Data Transmission (ISL8488E, ISL8489E)
- Single Unit Load Allows up to 32 Devices on the Bus (See ISL4489E, ISL4491E for 256 Devices on Bus)
- Low Quiescent Current:
 - 120µA (ISL8488E)
 - 140µA (ISL8489E)
 - 370µA (ISL8490E, ISL8491E)
- -7V to +12V Common Mode Input Voltage Range
- Three-State Rx and Tx Outputs (Except ISL8488E, ISL8490E)
- Full Duplex Pinout
- Operates from a Single +5V Supply (10% Tolerance)
- Current Limiting and Thermal Shutdown for Driver Overload Protection
- Pb-Free Plus Anneal Available (RoHS Compliant)

Applications

- Factory Automation
- Security Networks
- Building Environmental Control Systems
- Industrial/Process Control Networks
- Level Translators (e.g., RS-232 to RS-422)
- RS-232 "Extension Cords"

TABLE 1. SUMMARY OF FEATURES

PART NUMBER	HALF/FULL DUPLEX	HIGH ESD?	NO. OF DEVICES ALLOWED ON BUS	DATA RATE (Mbps)	SLEW-RATE LIMITED?	RECEIVER/ DRIVER ENABLE?	QUIESCENT I _{CC} (µA)	PIN COUNT
ISL8488E	Full	Yes	32	0.25	Yes	No	120	8
ISL8489E	Full	Yes	32	0.25	Yes	Yes	140	14
ISL8490E	Full	Yes	32	10	No	No	370	8
ISL8491E	Full	Yes	32	10	No	Yes	370	14

Pinouts

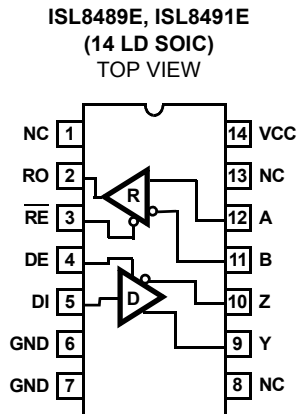
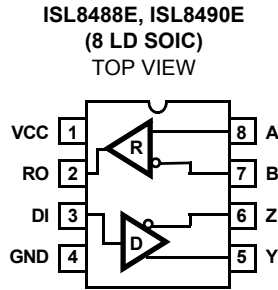

Ordering Information

PART NUMBER (Note 1)	PART MARKING	TEMP. RANGE (°C)	PACKAGE	PKG. DWG. #
ISL8488EIB	8488 EIB	-40 to +85	8 Ld SOIC	M8.15
ISL8488EIBZA (Note 2)	8488 EIBZ	-40 to +85	8 Ld SOIC (Pb-free)	M8.15
ISL8489EIB	ISL8489EIB	-40 to +85	14 Ld SOIC	M14.15
ISL8489EIBZ (Note 2)	8489EIBZ	-40 to +85	14 Ld SOIC (Pb-free)	M14.15
ISL8490EIBZ (Note 2)	8490E IBZ	-40 to +85	8 Ld SOIC (Pb-free)	M8.15
ISL8491EIB	ISL8491EIB	-40 to +85	14 Ld SOIC	M14.15
ISL8491EIBZ (Note 2)	8491EIBZ	-40 to +85	14 Ld SOIC (Pb-free)	M14.15

NOTES:

1. Add "-T" suffix for tape and reel. Please refer to TB347 for details on reel specifications.
2. Intersil Pb-free plus anneal products employ special Pb-free material sets; molding compounds/die attach materials and 100% matte tin plate termination finish, which are RoHS compliant and compatible with both SnPb and Pb-free soldering operations. Intersil Pb-free products are MSL classified at Pb-free peak reflow temperatures that meet or exceed the Pb-free requirements of IPC/JEDEC J STD-020.

Truth Tables (For ISL8488E, ISL8490E, only the DE = 1 and RE = 0 entries are valid)

TRANSMITTING				
INPUTS			OUTPUTS	
RE	DE	DI	Z	Y
X	1	1	0	1
X	1	0	1	0
X	0	X	High-Z	High-Z

RECEIVING			
INPUTS			OUTPUT
RE	DE	A-B	RO
0	X	≥ +0.2V	1
0	X	≤ -0.2V	0
0	X	Inputs Open	1
1	X	X	High-Z

Pin Descriptions

PIN	FUNCTION
RO	Receiver output: If A > B by at least 0.2V, RO is high; If A < B by 0.2V or more, RO is low; RO = High if A and B are unconnected (floating).
RE	Receiver output enable. RO is enabled when RE is low; RO is high impedance when RE is high.
DE	Driver output enable. The driver outputs, Y and Z, are enabled by bringing DE high. They are high impedance when DE is low.
DI	Driver input. A low on DI forces output Y low and output Z high. Similarly, a high on DI forces output Y high and output Z low.
GND	Ground connection.
A	±15kV HBM ESD Protected, Non-inverting receiver input.
B	±15kV HBM ESD Protected, Inverting receiver input.
Y	±15kV HBM ESD Protected, Non-inverting driver output.
Z	±15kV HBM ESD Protected, Inverting driver output.
VCC	System power supply input (4.5V to 5.5V).
NC	No Connection.

Typical Operating Circuit

ISL8488E, ISL8490E



ISL8489E, ISL8491E



Absolute Maximum Ratings

V_{CC} to GND	7V
Input Voltages	
DI, DE, RE	-0.5V to ($V_{CC} + 0.5V$)
Input/Output Voltages	
A, B, Y, Z	-8V to +12.5V
RO	-0.5V to ($V_{CC} + 0.5V$)
Short Circuit Duration	
Y, Z	Continuous
ESD Rating	See Specification Table

Thermal Information

Thermal Resistance (Typical)	θ_{JA} (°C/W)
8 Ld SOIC Package (Note 3)	170
14 Ld SOIC Package (Note 3)	128
Maximum Junction Temperature (Plastic Package)	+150°C
Maximum Storage Temperature Range	-65°C to +150°C
Pb-free reflow profile	see link below
	http://www.intersil.com/pbfree/Pb-FreeReflow.asp

Operating Conditions

Temperature Range	-40°C to +85°C
-------------------	----------------

CAUTION: Do not operate at or near the maximum ratings listed for extended periods of time. Exposure to such conditions may adversely impact product reliability and result in failures not covered by warranty.

NOTE:

- θ_{JA} is measured with the component mounted on a low effective thermal conductivity test board in free air. See Tech Brief TB379 for details.

Electrical Specifications Test Conditions: $V_{CC} = 4.5V$ to $5.5V$; Unless Otherwise Specified. Typicals are at $V_{CC} = 5V$, $T_A = +25^\circ C$, (Note 4).

PARAMETER	SYMBOL	TEST CONDITIONS	TEMP (°C)	MIN (NOTE 9)	TYP	MAX (NOTE 9)	UNITS	
DC CHARACTERISTICS								
Driver Differential V_{OUT} (no load)	V_{OD1}		Full	-	-	V_{CC}	V	
Driver Differential V_{OUT} (with load)	V_{OD2}	R = 50Ω (RS-422) (Figure 1)	Full	2	3	-	V	
		R = 27Ω (RS-485) (Figure 1)	Full	1.5	2.3	5	V	
Change in Magnitude of Driver Differential V_{OUT} for Complementary Output States	ΔV_{OD}	R = 27Ω or 50Ω (Figure 1)	Full	-	0.01	0.2	V	
Driver Common-Mode V_{OUT}	V_{OC}	R = 27Ω or 50Ω (Figure 1)	Full	-	-	3	V	
Change in Magnitude of Driver Common-Mode V_{OUT} for Complementary Output States	ΔV_{OC}	R = 27Ω or 50Ω (Figure 1)	Full	-	0.01	0.2	V	
Logic Input High Voltage	V_{IH}	DE, DI, \overline{RE}	Full	2	-	-	V	
Logic Input Low Voltage	V_{IL}	DE, DI, \overline{RE}	Full	0.8	-	-	V	
Logic Input Current	I_{IN1}	DI	Full	-2	-	2	μA	
		DE, \overline{RE} (Note 8)	Full	-40	-	40	μA	
Input Current (A, B) (Note 7)	I_{IN2}	DE = 0V, $V_{CC} = 0V$ or 4.5V to 5.5V	$V_{IN} = 12V$	Full	-	-	1	mA
			$V_{IN} = -7V$	Full	-0.8	-	-	mA
Driver Three-State Output Current (Y, Z)	I_{OZD}	DE = 0V, $-7V \leq V_O \leq 12V$ (Note 8)	Full	-100	-	100	μA	
Receiver Differential Threshold Voltage	V_{TH}	$-7V \leq V_{CM} \leq 12V$	Full	-0.2	-	0.2	V	
Receiver Input Hysteresis	ΔV_{TH}	$V_{CM} = 0V$	25	-	70	-	mV	
Receiver Output High Voltage	V_{OH}	$I_O = -4mA$, $V_{ID} = 200mV$	Full	3.5	-	-	V	
Receiver Output Low Voltage	V_{OL}	$I_O = 4mA$, $V_{ID} = 200mV$	Full	-	-	0.4	V	
Receiver Three-State Output Current	I_{OZR}	$\overline{RE} = V_{CC}$, $0.4V \leq V_O \leq 2.4V$ (Note 8)	Full	-	-	±1	μA	
Receiver Input Resistance	R_{IN}	$-7V \leq V_{CM} \leq 12V$	Full	12	-	-	kΩ	
No-Load Supply Current (Note 5)	I_{CC}	ISL8488E, DI = 0V or V_{CC}	Full	-	120	140	μA	
		ISL8489E, DE, DI, $\overline{RE} = 0V$ or V_{CC}	Full	-	140	190	μA	
		ISL8490E/ISL8491E, DE, DI, $\overline{RE} = 0V$ or V_{CC}	Full	-	370	460	μA	
Driver Short-Circuit Current, $V_O =$ High or Low	I_{OSD1}	DE = V_{CC} , $-7V \leq V_Y$ or $V_Z \leq 12V$ (Note 6)	Full	35	-	250	mA	

Electrical Specifications Test Conditions: $V_{CC} = 4.5V$ to $5.5V$; Unless Otherwise Specified. Typical values are at $V_{CC} = 5V$, $T_A = +25^\circ C$, (Note 4). (Continued)

PARAMETER	SYMBOL	TEST CONDITIONS	TEMP (°C)	MIN (NOTE 9)	TYP	MAX (NOTE 9)	UNITS
Receiver Short-Circuit Current	I_{OSR}	$0V \leq V_O \leq V_{CC}$	Full	7	-	85	mA
SWITCHING CHARACTERISTICS (ISL8488E, ISL8489E)							
Driver Input to Output Delay	t_{PLH}, t_{PHL}	$R_{DIFF} = 54\Omega, C_L = 100pF$ (Figure 2)	Full	250	400	2000	ns
Driver Output Skew	t_{SKEW}	$R_{DIFF} = 54\Omega, C_L = 100pF$ (Figure 2)	Full	-	160	800	ns
Driver Differential Rise or Fall Time	t_R, t_F	$R_{DIFF} = 54\Omega, C_L = 100pF$ (Figure 2)	Full	250	600	2000	ns
Driver Enable to Output High	t_{ZH}	$C_L = 100pF, SW = GND$ (Figure 3, Note 8)	Full	250	1000	2000	ns
Driver Enable to Output Low	t_{ZL}	$C_L = 100pF, SW = V_{CC}$ (Figure 3, Note 8)	Full	250	860	2000	ns
Driver Disable from Output High	t_{HZ}	$C_L = 15pF, SW = GND$ (Figure 3, Note 8)	Full	300	660	3000	ns
Driver Disable from Output Low	t_{LZ}	$C_L = 15pF, SW = V_{CC}$ (Figure 3, Note 8)	Full	300	640	3000	ns
Receiver Input to Output Delay	t_{PLH}, t_{PHL}	(Figure 4)	Full	250	500	2000	ns
Receiver Skew $t_{PLH} - t_{PHL}$	t_{SKD}	(Figure 4)	25	-	60	-	ns
Receiver Enable to Output High	t_{ZH}	$C_L = 15pF, SW = GND$ (Figure 5, Note 8)	Full	-	10	50	ns
Receiver Enable to Output Low	t_{ZL}	$C_L = 15pF, SW = V_{CC}$ (Figure 5, Note 8)	Full	-	10	50	ns
Receiver Disable from Output High	t_{HZ}	$C_L = 15pF, SW = GND$ (Figure 5, Note 8)	Full	-	10	50	ns
Receiver Disable from Output Low	t_{LZ}	$C_L = 15pF, SW = V_{CC}$ (Figure 5, Note 8)	Full	-	10	50	ns
Maximum Data Rate	f_{MAX}		Full	250	-	-	kbps
SWITCHING CHARACTERISTICS (ISL8490E, ISL8491E)							
Driver Input to Output Delay	t_{PLH}, t_{PHL}	$R_{DIFF} = 54\Omega, C_L = 100pF$ (Figure 2)	Full	13	24	50	ns
Driver Output Skew	t_{SKEW}	$R_{DIFF} = 54\Omega, C_L = 100pF$ (Figure 2)	Full	-	3	10	ns
Driver Differential Rise or Fall Time	t_R, t_F	$R_{DIFF} = 54\Omega, C_L = 100pF$ (Figure 2)	Full	5	12	25	ns
Driver Enable to Output High	t_{ZH}	$C_L = 100pF, SW = GND$ (Figure 3, Note 8)	Full	-	14	70	ns
Driver Enable to Output Low	t_{ZL}	$C_L = 100pF, SW = V_{CC}$ (Figure 3, Note 8)	Full	-	14	70	ns
Driver Disable from Output High	t_{HZ}	$C_L = 15pF, SW = GND$ (Figure 3, Note 8)	Full	-	44	70	ns
Driver Disable from Output Low	t_{LZ}	$C_L = 15pF, SW = V_{CC}$ (Figure 3, Note 8)	Full	-	21	70	ns
Receiver Input to Output Delay	t_{PLH}, t_{PHL}	(Figure 4)	Full	30	90	150	ns
Receiver Skew $t_{PLH} - t_{PHL}$	t_{SKD}	(Figure 4)	25	-	5	-	ns
Receiver Enable to Output High	t_{ZH}	$C_L = 15pF, SW = GND$ (Figure 5, Note 8)	Full	-	9	50	ns
Receiver Enable to Output Low	t_{ZL}	$C_L = 15pF, SW = V_{CC}$ (Figure 5, Note 8)	Full	-	9	50	ns
Receiver Disable from Output High	t_{HZ}	$C_L = 15pF, SW = GND$ (Figure 5, Note 8)	Full	-	9	50	ns
Receiver Disable from Output Low	t_{LZ}	$C_L = 15pF, SW = V_{CC}$ (Figure 5, Note 8)	Full	-	9	50	ns
Maximum Data Rate	f_{MAX}		Full	10	-	-	Mbps
ESD PERFORMANCE							
RS-485 Pins (A, B, Y, Z)		Human Body Model	25	-	± 15	-	kV
All Other Pins			25	-	$> \pm 7$	-	kV

NOTES:

- All currents into device pins are positive; all currents out of device pins are negative. All voltages are referenced to device ground unless otherwise specified.
- Supply current specification is valid for loaded drivers when $DE = 0V$.
- Applies to peak current. See "Typical Performance Curves" on page 9 for more information.
- Devices meeting these limits are denoted as "single unit load (1 UL)" transceivers. The RS-485 standard allows up to 32 Unit Loads on the bus.
- Not applicable to the ISL8488E, ISL8490E.
- Parts are 100% tested at $+25^\circ C$. Over-temperature limits established by characterization and are not production tested.

Test Circuits and Waveforms



FIGURE 1. DRIVER V_{OD} AND V_{OC}



FIGURE 2A. TEST CIRCUIT



$$SKEW = |t_{PLH}(Y \text{ or } Z) - t_{PHL}(Z \text{ or } Y)|$$

FIGURE 2B. MEASUREMENT POINTS

FIGURE 2. DRIVER PROPAGATION DELAY AND DIFFERENTIAL TRANSITION TIMES

Test Circuits and Waveforms (Continued)



PARAMETER	OUTPUT	\overline{RE}	DI	SW	C_L (pF)
t_{HZ}	Y/Z	X	1/0	GND	15
t_{LZ}	Y/Z	X	0/1	V_{CC}	15
t_{ZH}	Y/Z	X	1/0	GND	100
t_{ZL}	Y/Z	X	0/1	V_{CC}	100

FIGURE 3A. TEST CIRCUIT

FIGURE 3. DRIVER ENABLE AND DISABLE TIMES (EXCLUDING ISL8488E, ISL8490E)

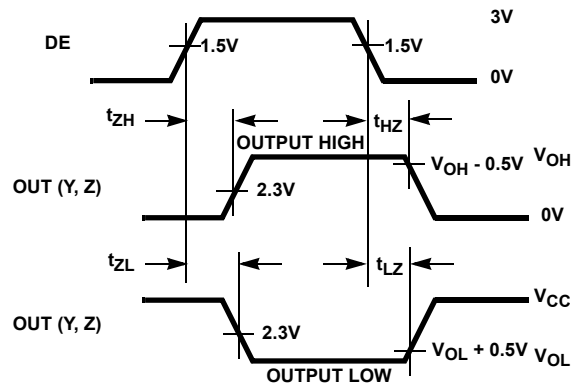

FIGURE 3B. MEASUREMENT POINTS

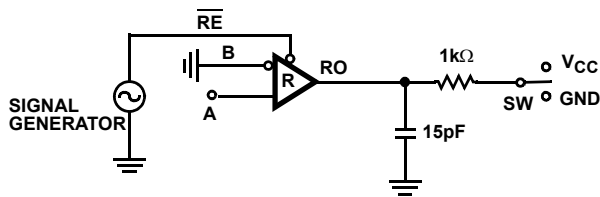

FIGURE 4A. TEST CIRCUIT

FIGURE 4. RECEIVER PROPAGATION DELAY



FIGURE 4B. MEASUREMENT POINTS



PARAMETER	DE	A	SW
t_{HZ}	X	+1.5V	GND
t_{LZ}	X	-1.5V	V_{CC}
t_{ZH}	X	+1.5V	GND
t_{ZL}	X	-1.5V	V_{CC}

FIGURE 5A. TEST CIRCUIT

FIGURE 5. RECEIVER ENABLE AND DISABLE TIMES (EXCLUDING ISL8488E, ISL8490E)

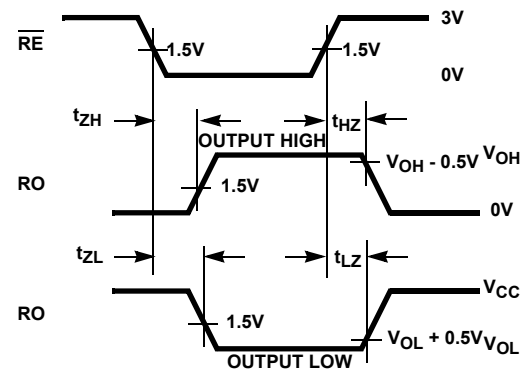

FIGURE 5B. MEASUREMENT POINTS

Application Information

RS-485 and RS-422 are differential (balanced) data transmission standards for use in long haul or noisy environments. RS-422 is a subset of RS-485, so RS-485 transceivers are also RS-422 compliant. RS-422 is a point-to-multipoint (multidrop) standard, which allows only one driver and up to 10 (assuming one unit load devices) receivers on each bus. RS-485 is a true multipoint standard, which allows up to 32 one unit load devices (any combination of drivers and receivers) on each bus. To allow for multipoint operation, the RS-485 specification requires that drivers must handle bus contention without sustaining any damage.

Another important advantage of RS-485 is the extended common mode range (CMR), which specifies that the driver outputs and receiver inputs withstand signals that range from +12V to -7V. RS-422 and RS-485 are intended for runs as long as 4000', so the wide CMR is necessary to handle ground potential differences, as well as voltages induced in the cable by external fields.

Receiver Features

These devices utilize a differential input receiver for maximum noise immunity and common mode rejection. Input sensitivity is $\pm 200\text{mV}$, as required by the RS-422 and RS-485 specifications.

Receiver input resistance surpasses the RS-422 specification of $4\text{k}\Omega$, and meets the RS-485 "Unit Load" requirement of $12\text{k}\Omega$ minimum.

Receiver inputs function with common mode voltages as great as $\pm 7\text{V}$ outside the power supplies (i.e., +12V and -7V), making them ideal for long networks where induced voltages are a realistic concern.

All the receivers include a "fail-safe if open" function that guarantees a high level receiver output if the receiver inputs are unconnected (floating).

Receivers easily meet the data rate supported by the corresponding driver. ISL8489E/ISL8491E receiver outputs are three-statable via the active low $\overline{\text{RE}}$ input.

Driver Features

The RS-485/RS-422 driver is a differential output device that delivers at least 1.5V across a 54Ω load (RS-485), and at least 2V across a 100Ω load (RS-422). The drivers feature low propagation delay skew to maximize bit width, and to minimize EMI. ISL8489E/ISL8491E driver outputs are three-statable via the active high DE input.

The ISL8488E/ISL8489E driver outputs are slew rate limited to further reduce EMI, and to minimize reflections in unterminated or improperly terminated networks. Data rates on these slew rate limited versions are a maximum of 250kbps. Outputs of ISL8490E/ISL8491E drivers are not limited, so faster output transition times allow data rates of at least 10Mbps.

Data Rate, Cables, and Terminations

Twisted pair is the cable of choice for RS-485/RS-422 networks. Twisted pair cables tend to pick up noise and other electromagnetically induced voltages as common mode signals, which are effectively rejected by the differential receivers in these ICs.

RS-485/RS-422 are intended for network lengths up to 4000', but the maximum system data rate decreases as the transmission length increases. Devices operating at 10Mbps are limited to lengths of a few hundred feet, while the 250kbps versions can operate at full data rates with lengths in excess of 1000'.

Proper termination is imperative, when using the 10Mbps devices, to minimize reflections. Short networks using the 250kbps versions need not be terminated, but, terminations are recommended unless power dissipation is an overriding concern. In point-to-point, or point-to-multipoint (single driver on bus) networks, the main cable should be terminated in its characteristic impedance (typically 120Ω) at the end farthest from the driver. In multi-receiver applications, stubs connecting receivers to the main cable should be kept as short as possible. Multipoint (multi-driver) systems require that the main cable be terminated in its characteristic impedance at both ends. Stubs connecting a transceiver to the main cable should be kept as short as possible.

Built-In Driver Overload Protection

As stated previously, the RS-485 specification requires that drivers survive worst case bus contentions undamaged. The ISL84xxE devices meet this requirement via driver output short circuit current limits, and on-chip thermal shutdown circuitry.

The driver output stages incorporate short circuit current limiting circuitry which ensures that the output current never exceeds the RS-485 specification, even at the common mode voltage range extremes. Additionally, these devices utilize a foldback circuit which reduces the short circuit current, and thus the power dissipation, whenever the contending voltage exceeds either supply.

In the event of a major short circuit condition, ISL84xxE devices also include a thermal shutdown feature that disables the drivers whenever the die temperature becomes excessive. This eliminates the power dissipation, allowing the die to cool. The drivers automatically reenables after the die temperature drops about 15° . If the contention persists, the thermal shutdown/reenable cycle repeats until the fault is cleared. Receivers stay operational during thermal shutdown.

ESD Protection

All pins on these devices include class 3 Human Body Model (HBM) ESD protection structures, but the RS-485 pins (driver outputs and receiver inputs) incorporate advanced structures allowing them to survive ESD events in excess of

±15kV HBM. The RS-485 pins are particularly vulnerable to ESD damage because they typically connect to an exposed port on the exterior of the finished product. Simply touching the port pins, or connecting a cable, can cause an ESD event that might destroy unprotected ICs. These new ESD structures protect the device whether or not it is powered up,

protect without allowing any latch-up mechanism to activate, and without degrading the RS-485 common mode range of -7V to +12V. This built-in ESD protection eliminates the need for board level protection structures (e.g., transient suppression diodes), and the associated, undesirable capacitive load they present.

Typical Performance Curves $V_{CC} = 5V, T_A = +25^{\circ}C$; Unless Otherwise Specified.

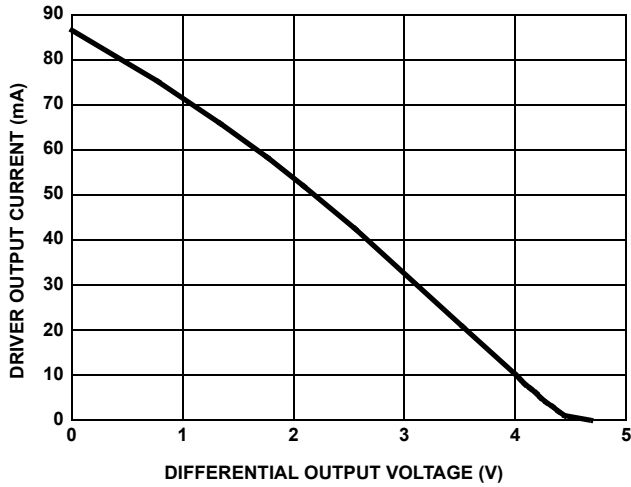

FIGURE 6. DRIVER OUTPUT CURRENT vs DIFFERENTIAL OUTPUT VOLTAGE

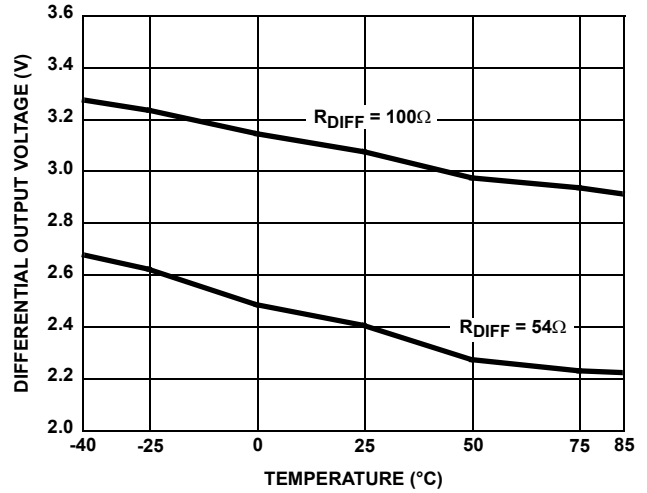

FIGURE 7. DRIVER DIFFERENTIAL OUTPUT VOLTAGE vs TEMPERATURE

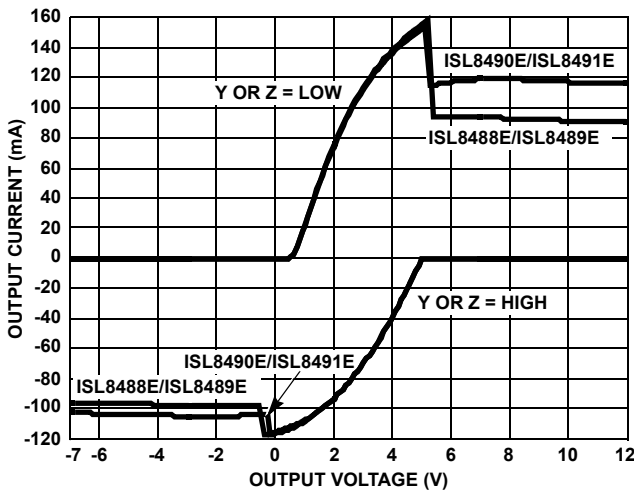

FIGURE 8. DRIVER OUTPUT CURRENT vs SHORT CIRCUIT VOLTAGE



FIGURE 9. SUPPLY CURRENT vs TEMPERATURE

Typical Performance Curves $V_{CC} = 5V, T_A = +25^\circ C$; Unless Otherwise Specified.



FIGURE 10. DRIVER PROPAGATION DELAY vs TEMPERATURE (ISL8488E/ISL8489E)



FIGURE 11. DRIVER SKEW vs TEMPERATURE (ISL8488E/ISL8489E)

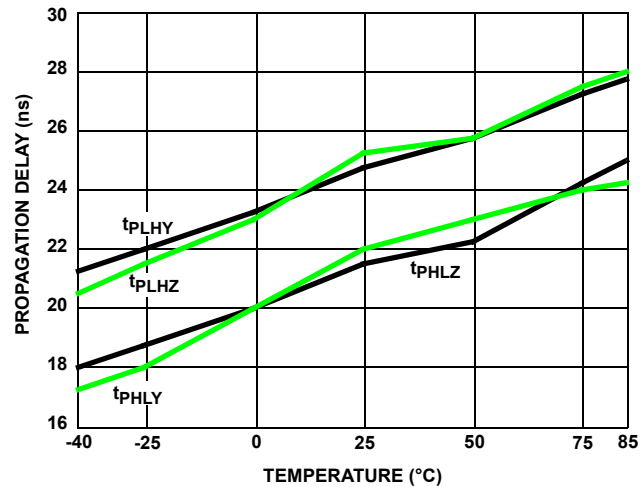

FIGURE 12. DRIVER PROPAGATION DELAY vs TEMPERATURE (ISL8490E/ISL8491E)

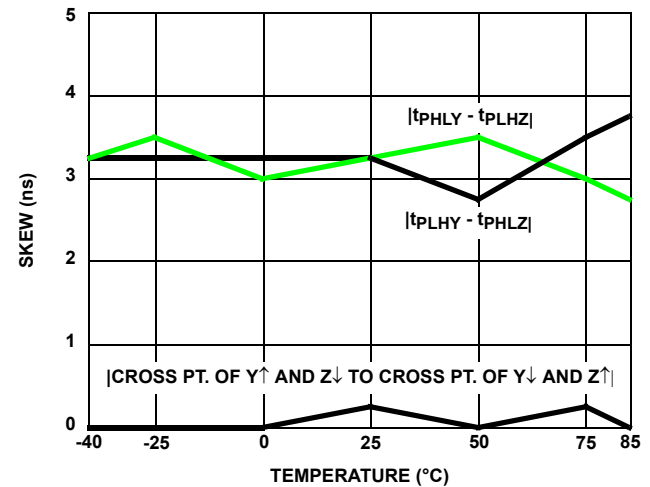

FIGURE 13. DRIVER SKEW vs TEMPERATURE (ISL8490E/ISL8491E)

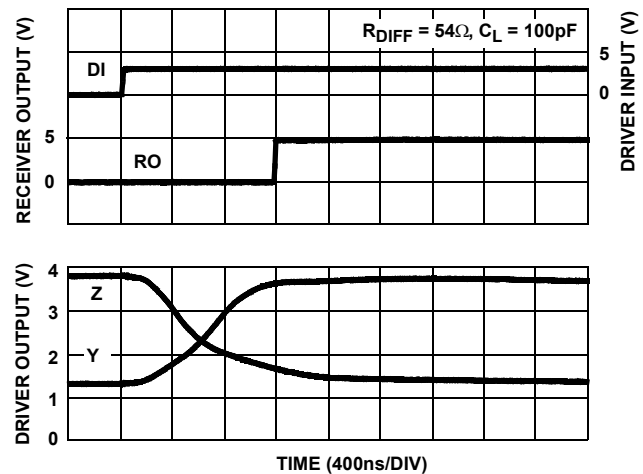

FIGURE 14. DRIVER AND RECEIVER WAVEFORMS, LOW TO HIGH (ISL8488E/ISL8489E)



FIGURE 15. DRIVER AND RECEIVER WAVEFORMS, HIGH TO LOW (ISL8488E/ISL8489E)

Typical Performance Curves $V_{CC} = 5V, T_A = +25^{\circ}C$; Unless Otherwise Specified.

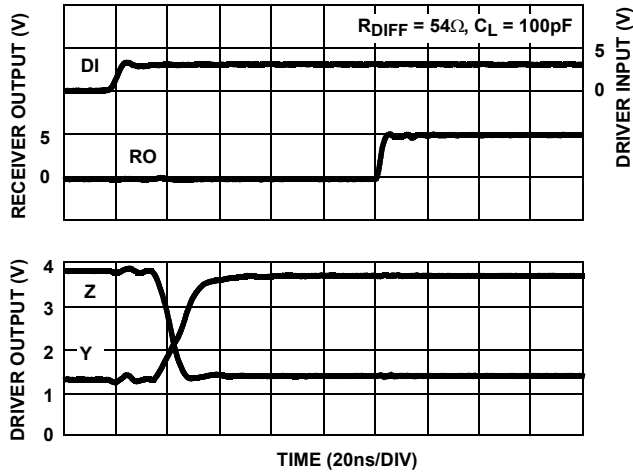

FIGURE 16. DRIVER AND RECEIVER WAVEFORMS, LOW TO HIGH (ISL8490E/ISL8491E)

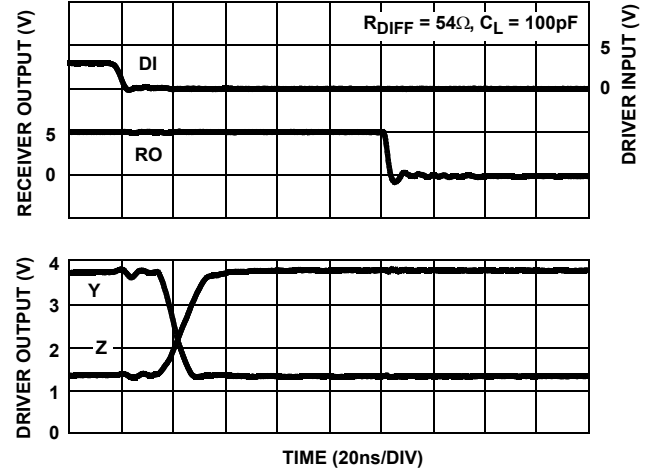

FIGURE 17. DRIVER AND RECEIVER WAVEFORMS, HIGH TO LOW (ISL8490E/ISL8491E)

Die Characteristics

SUBSTRATE POTENTIAL (POWERED UP):

GND

TRANSISTOR COUNT:

518

PROCESS:

Si Gate BiCMOS

Small Outline Plastic Packages (SOIC)

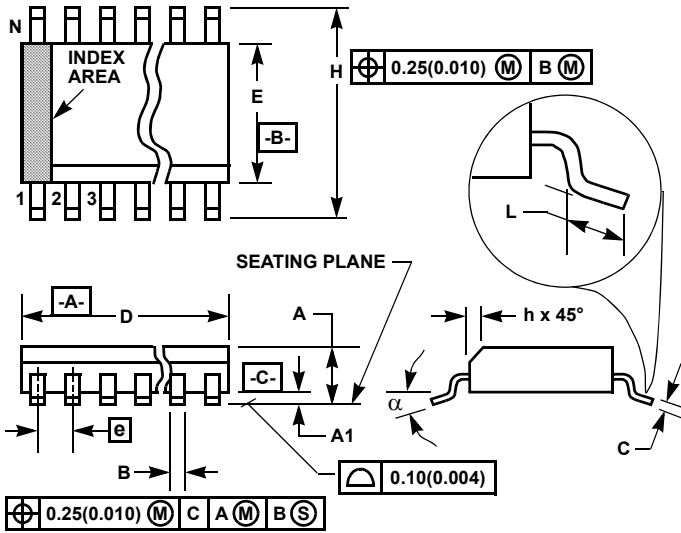

**M8.15 (JEDEC MS-012-AA ISSUE C)
8 LEAD NARROW BODY SMALL OUTLINE PLASTIC PACKAGE**

SYMBOL	INCHES		MILLIMETERS		NOTES
	MIN	MAX	MIN	MAX	
A	0.0532	0.0688	1.35	1.75	-
A1	0.0040	0.0098	0.10	0.25	-
B	0.013	0.020	0.33	0.51	9
C	0.0075	0.0098	0.19	0.25	-
D	0.1890	0.1968	4.80	5.00	3
E	0.1497	0.1574	3.80	4.00	4
e	0.050 BSC		1.27 BSC		-
H	0.2284	0.2440	5.80	6.20	-
h	0.0099	0.0196	0.25	0.50	5
L	0.016	0.050	0.40	1.27	6
N	8		8		7
α	0°	8°	0°	8°	-

Rev. 1 6/05

NOTES:

1. Symbols are defined in the "MO Series Symbol List" in Section 2.2 of Publication Number 95.
2. Dimensioning and tolerancing per ANSI Y14.5M-1982.
3. Dimension "D" does not include mold flash, protrusions or gate burrs. Mold flash, protrusion and gate burrs shall not exceed 0.15mm (0.006 inch) per side.
4. Dimension "E" does not include interlead flash or protrusions. Interlead flash and protrusions shall not exceed 0.25mm (0.010 inch) per side.
5. The chamfer on the body is optional. If it is not present, a visual index feature must be located within the crosshatched area.
6. "L" is the length of terminal for soldering to a substrate.
7. "N" is the number of terminal positions.
8. Terminal numbers are shown for reference only.
9. The lead width "B", as measured 0.36mm (0.014 inch) or greater above the seating plane, shall not exceed a maximum value of 0.61mm (0.024 inch).
10. Controlling dimension: MILLIMETER. Converted inch dimensions are not necessarily exact.

Small Outline Plastic Packages (SOIC)

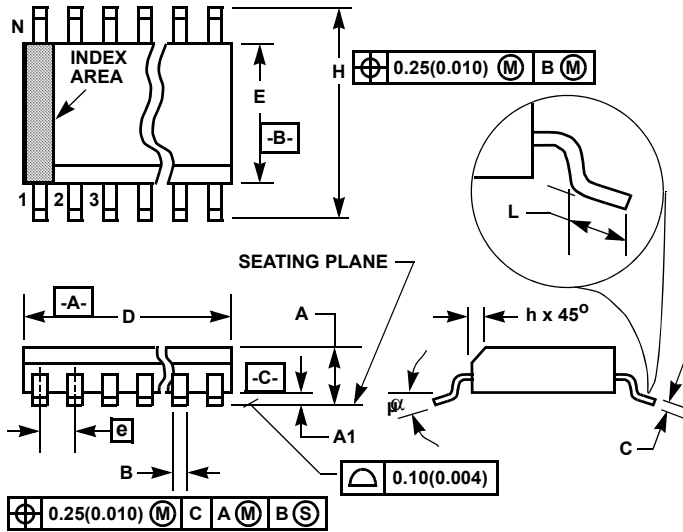

**M14.15 (JEDEC MS-012-AB ISSUE C)
14 LEAD NARROW BODY SMALL OUTLINE PLASTIC PACKAGE**

SYMBOL	INCHES		MILLIMETERS		NOTES
	MIN	MAX	MIN	MAX	
A	0.0532	0.0688	1.35	1.75	-
A1	0.0040	0.0098	0.10	0.25	-
B	0.013	0.020	0.33	0.51	9
C	0.0075	0.0098	0.19	0.25	-
D	0.3367	0.3444	8.55	8.75	3
E	0.1497	0.1574	3.80	4.00	4
e	0.050 BSC		1.27 BSC		-
H	0.2284	0.2440	5.80	6.20	-
h	0.0099	0.0196	0.25	0.50	5
L	0.016	0.050	0.40	1.27	6
N	14		14		7
α	0°	8°	0°	8°	-

NOTES:

1. Symbols are defined in the "MO Series Symbol List" in Section 2.2 of Publication Number 95.
2. Dimensioning and tolerancing per ANSI Y14.5M-1982.
3. Dimension "D" does not include mold flash, protrusions or gate burrs. Mold flash, protrusion and gate burrs shall not exceed 0.15mm (0.006 inch) per side.
4. Dimension "E" does not include interlead flash or protrusions. Interlead flash and protrusions shall not exceed 0.25mm (0.010 inch) per side.
5. The chamfer on the body is optional. If it is not present, a visual index feature must be located within the crosshatched area.
6. "L" is the length of terminal for soldering to a substrate.
7. "N" is the number of terminal positions.
8. Terminal numbers are shown for reference only.
9. The lead width "B", as measured 0.36mm (0.014 inch) or greater above the seating plane, shall not exceed a maximum value of 0.61mm (0.024 inch).
10. Controlling dimension: MILLIMETER. Converted inch dimensions are not necessarily exact.

Rev. 0 12/93

© Copyright Intersil Americas LLC 2004-2007. All Rights Reserved.
All trademarks and registered trademarks are the property of their respective owners.

For additional products, see www.intersil.com/en/products.html

Intersil products are manufactured, assembled and tested utilizing ISO9001 quality systems as noted in the quality certifications found at www.intersil.com/en/support/qualandreliability.html

Intersil products are sold by description only. Intersil may modify the circuit design and/or specifications of products at any time without notice, provided that such modification does not, in Intersil's sole judgment, affect the form, fit or function of the product. Accordingly, the reader is cautioned to verify that datasheets are current before placing orders. Information furnished by Intersil is believed to be accurate and reliable. However, no responsibility is assumed by Intersil or its subsidiaries for its use; nor for any infringements of patents or other rights of third parties which may result from its use. No license is granted by implication or otherwise under any patent or patent rights of Intersil or its subsidiaries.

For information regarding Intersil Corporation and its products, see www.intersil.com

Компания «Life Electronics» занимается поставками электронных компонентов импортного и отечественного производства от производителей и со складов крупных дистрибьюторов Европы, Америки и Азии.

С конца 2013 года компания активно расширяет линейку поставок компонентов по направлению коаксиальный кабель, кварцевые генераторы и конденсаторы (керамические, пленочные, электролитические), за счёт заключения дистрибьюторских договоров

Мы предлагаем:

- Конкурентоспособные цены и скидки постоянным клиентам.
- Специальные условия для постоянных клиентов.
- Подбор аналогов.
- Поставку компонентов в любых объемах, удовлетворяющих вашим потребностям.
- Приемлемые сроки поставки, возможна ускоренная поставка.
- Доставку товара в любую точку России и стран СНГ.
- Комплексную поставку.
- Работу по проектам и поставку образцов.
- Формирование склада под заказчика.
- Сертификаты соответствия на поставляемую продукцию (по желанию клиента).
- Тестирование поставляемой продукции.
- Поставку компонентов, требующих военную и космическую приемку.
- Входной контроль качества.
- Наличие сертификата ISO.

В составе нашей компании организован Конструкторский отдел, призванный помогать разработчикам, и инженерам.

Конструкторский отдел помогает осуществить:

- Регистрацию проекта у производителя компонентов.
- Техническую поддержку проекта.
- Защиту от снятия компонента с производства.
- Оценку стоимости проекта по компонентам.
- Изготовление тестовой платы монтаж и пусконаладочные работы.



Тел: +7 (812) 336 43 04 (многоканальный)

Email: org@lifeelectronics.ru