

### Product Overview

The QPB9329 is a highly integrated front-end module targeted for TDD base stations. The switch LNA module integrates a two-stage LNA and a high power switch in a dual channel configuration. The second stage LNA has a bypass mode. Power down and bypass capability for the LNAs can be controlled with control pins on the module.

The QPB9329 can be utilized across the 3.8 – 6.0 GHz range to provide 1.8 dB noise figure for operation in the receive mode and 1.1 dB insertion loss in the transmit mode at 4.5 GHz. The LNAs utilize Qorvo’s high performance E-pHEMT process while the SOI technology based switch supports input RF power signals of up to 8W average power assuming 8 dB PAR. The product only needs a +5V supply to operate the high-power switch and the LNAs.

The QPB9329 is packaged in a RoHS-compliant, compact 7 mm x 7 mm surface-mount leadless package. The switch LNA module is targeted for wireless infrastructure applications configured for TDD-based MIMO architectures. The module can be used for next generation 5G or pre-5G solutions or small cell base-station applications.

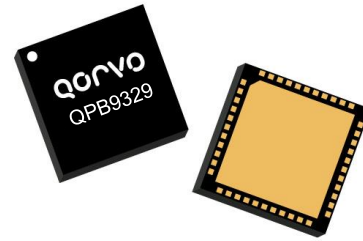

44 Pin 7 mm x 7 mm leadless SMT Package

### Key Features

- 3.8 – 6.0 GHz Frequency Range
- Dual Channel
- Second LNA has bypass mode
- Max RF Input power: 8W Pavg (8 dB PAR), TX mode
- 1.8 dB NF at 4.5 GHz (Rx mode)
- 31.5 dB Gain (Rx mode, High Gain state)
- 16.5 dB Gain (RX mode, Low Gain state)
- +33 dBm OIP3 (Rx mode, High gain state)
- 1.8V TTL logic compatibility
- 3 – 5V operation for switch and LNAs

### Functional Block Diagram

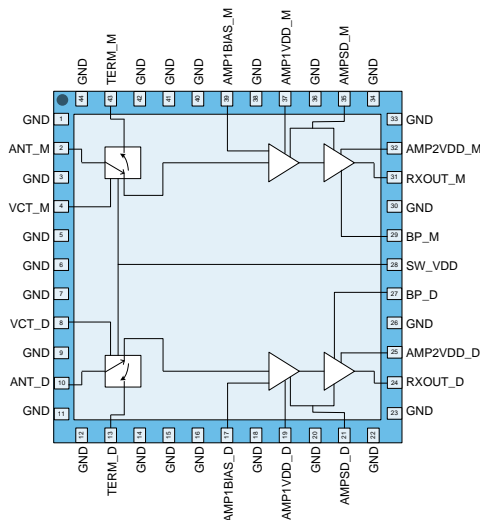

Top View

### Applications

- Wireless Infrastructure
- Small cell BTS
- Pre-5G / 5G Massive MIMO systems
- TDD-based architectures

### Ordering Information

Part No.	Description
QPB9329EVB-01	Evaluation Board
QPB9329SR	100 pcs on a 7" reel
QPB9329TR13	2500 pcs on a 13" reel

## Absolute Maximum Ratings

Parameter	Rating
Storage Temperature	-65 to 150 °C
Supply Voltage (Pins 17, 19, 25, 32, 37, 38)	+7 V
Pin at ANT, Rx mode (Pavg, 8 dB PAR, 100% DC, 105°C)	27 dBm
Pin at ANT, Tx mode (Pavg, 8 dB PAR, 88% DC, 8.8ms max pulse-width, 105°C)	39 dBm

Operation of this device outside the parameter ranges given above may cause permanent damage.

## Recommended Operating Conditions

Parameter	Min	Typ	Max	Units
LNA Voltage	+3	+5	+5.25	V
Switch V <sub>DD</sub>	+3	+5	+5.5	V
T <sub>CASE</sub>	-40		+105	°C
T <sub>j</sub> at max T <sub>case</sub> <sup>(1)</sup>			+136	°C
T <sub>j</sub> at max T <sub>case</sub> <sup>(2)</sup>			+125	°C

Notes:

- For RX Mode operation
- For TX Mode operation with 5W Pavg power in and >1e6hrs MTTF

Electrical specifications are measured at specified test conditions.

Specifications are not guaranteed over all recommended operating conditions.

## Electrical Specifications

Parameter	Conditions <sup>(1)</sup>	Min	Typ	Max	Units
Operational Frequency Range		3800		6000	MHz
Test Frequency			4500		MHz
Gain <sup>(2)</sup>	Rx mode, High Gain state	28.5	31.5	33	dB
Gain <sup>(2)</sup>	RX mode, Low Gain state	15	16.5	18.5	dB
Gain Flatness	Rx mode, Any 100 MHz BW within band		0.8	1.5	dB
Noise Figure <sup>(2)</sup>	Rx mode		1.8	2.2	dB
Output IP3	Rx mode, High Gain state Pout/tone = +3dBm, Δf = 1MHz	+27.5	+33		dBm
	Rx mode, Low Gain state Pout/tone = +3dBm, Δf = 1MHz	+27.5	+33.5		dBm
OP1dB <sup>(2)</sup>	RX mode, High Gain state	+15	+16.5		dBm
	RX mode, Low Gain state	+15	+18		dBm
Insertion Loss <sup>(2)</sup>	Tx mode		1.1	1.6	dB
Input Return Loss	RX mode		10		dB
Output Return Loss	RX mode		10		dB
Return Loss	TX mode		17		dB
Switch Isolation	ANT to TX in RX mode	25			dB
Switch Isolation	ANT to RX in TX mode	60			dB
Channel Isolation	ANT M/D to RX D/M	38			dB
Channel Isolation	TX-TX or RX-RX	40			dB
LNA Current	Rx mode, High gain state, Per channel		120	165	mA
LNA Current	Rx mode, Low gain state, Per channel		60	85	mA
LNA Shutdown Current	Per channel		6	9	mA
LNA and Switch Control Voltage (Pins 4,8,21,27,29,35)	V <sub>low</sub>	0		+0.63	V
	V <sub>high</sub>	+1.17		V <sub>DD</sub>	V
LNA & Switch Control pin current	Logic high		1		μA
Switch Current	Tx mode			0.5	mA
Switch switching time (50% Vct to 90%/10% RFout)	ANT-TX rise time		0.89	1.05	μs
	ANT-TX fall time		0.78	1	μs
	ANT-RX rise time		0.98	1.2	μs
	ANT-RX fall time		0.61	1	μs
Thermal Resistance	Tx Mode			22.7	°C/W
	Rx High Gain Mode			23	°C/W

Notes:

- Test conditions unless otherwise noted: V<sub>DD</sub> = +5V; Temp = +25 °C, 50 Ω system.
- Trace loss de-embedded.

### Control bits settings for Switch state and Rx path gain mode.

	VCT (switch control) Pins 4 & 8 (J7 & J8 on EVB)	AMPSD Pins 21 & 35 (J14 & J11 on EVB)	BP Pins 27 & 29 (J16 & J18)
RX mode (high gain state)	0	0	0
RX mode (low gain state)	0	0	1
TX mode	1	1	0

### Evaluation Board Schematic

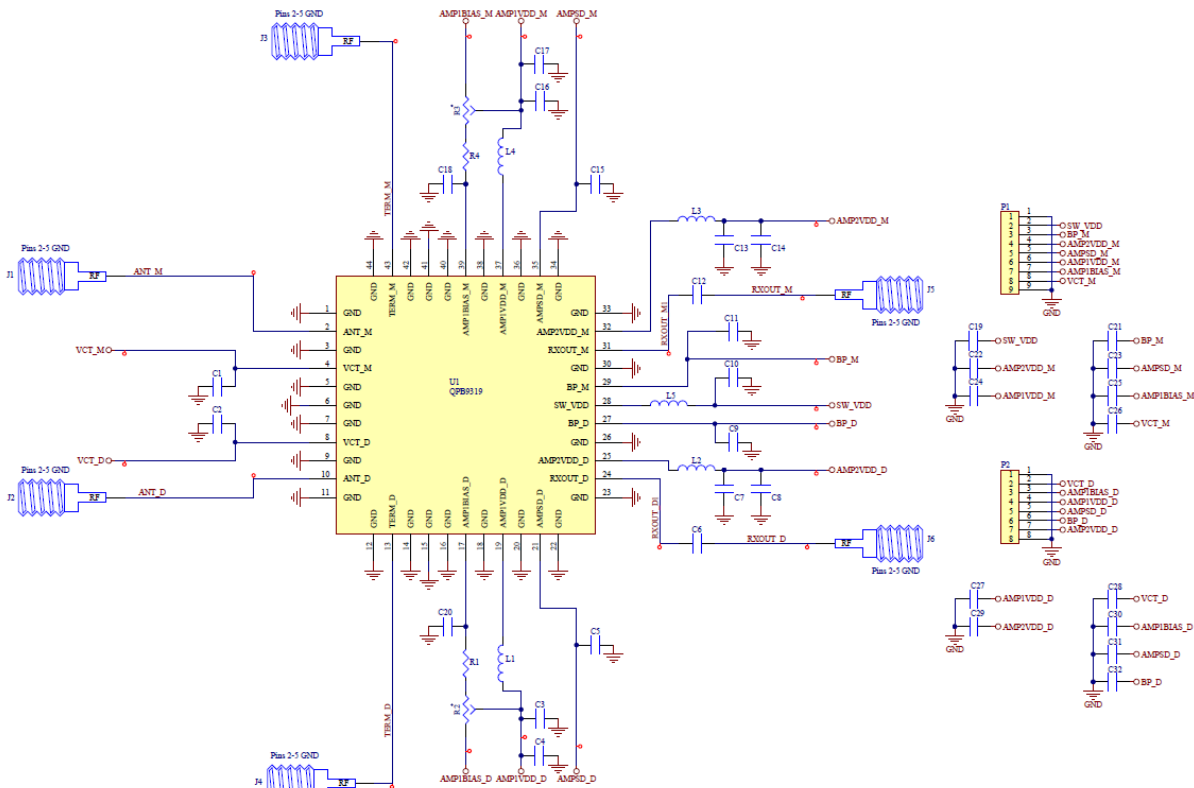

### Bill of Material – Evaluation Board

Reference Des.	Value	Description	Manuf.	Part Number
U1	N/A	Dual-Channel Switch-LNA Module	Qorvo	QPB9329
PCB	n/a	PCB, QPB9329		
C6,C12	8.2 pF	CAP, 5%, 50V, C0G, 0402	MURATA	GRM1555C1H8R2CA01D
C22,C24,C27,C29	0.1 uF	CAP, 10%, 10V, X7R, 0402	TAIYO	LMK105B7104KV-F
C9,C11	1000 pF	CAP, 10%, 16V, X7R, 0201	AVX	0201YC102KAT2A
C1,C2,C4,C5,C7,C13,C15,C16,C18,C20,C21,C32	1000 pF	CAP, 10%, 25V, STD, 0402	TDK	C1005X7R1E102K
C3,C8,C14,C17	1 uF	CAP, 10%, 6.3V, X7R, 0402	MURATA	GRM155R70J105KA12D
C10	0.01 uF	CAP, 10%, 6.3V, X7R, 0201	MURATA	GRM033R70J103KA01D
R2,R3	0 Ω	RES, 5%, 1/10W, 0402	Kamaya	RMC1/16SJPTH
R1,R4	5.1K Ω	RES, 5%, 1/16W, 0402	KOA Speer	RK73B1ETTP512J
L2,L3	7.5 nH	IND, 3%, W/W, 0402	MURATA	LQW15AN7N5G80D
L1,L4	3.9 nH	IND, +/-0.1nH, W/W, 0402	MURATA	LQW15AN3N9B00D
L5	7.5 nH	IND, 3%, T/F, 0201	MURATA	LQP03TG7N5H02D

Evaluation Board Layout

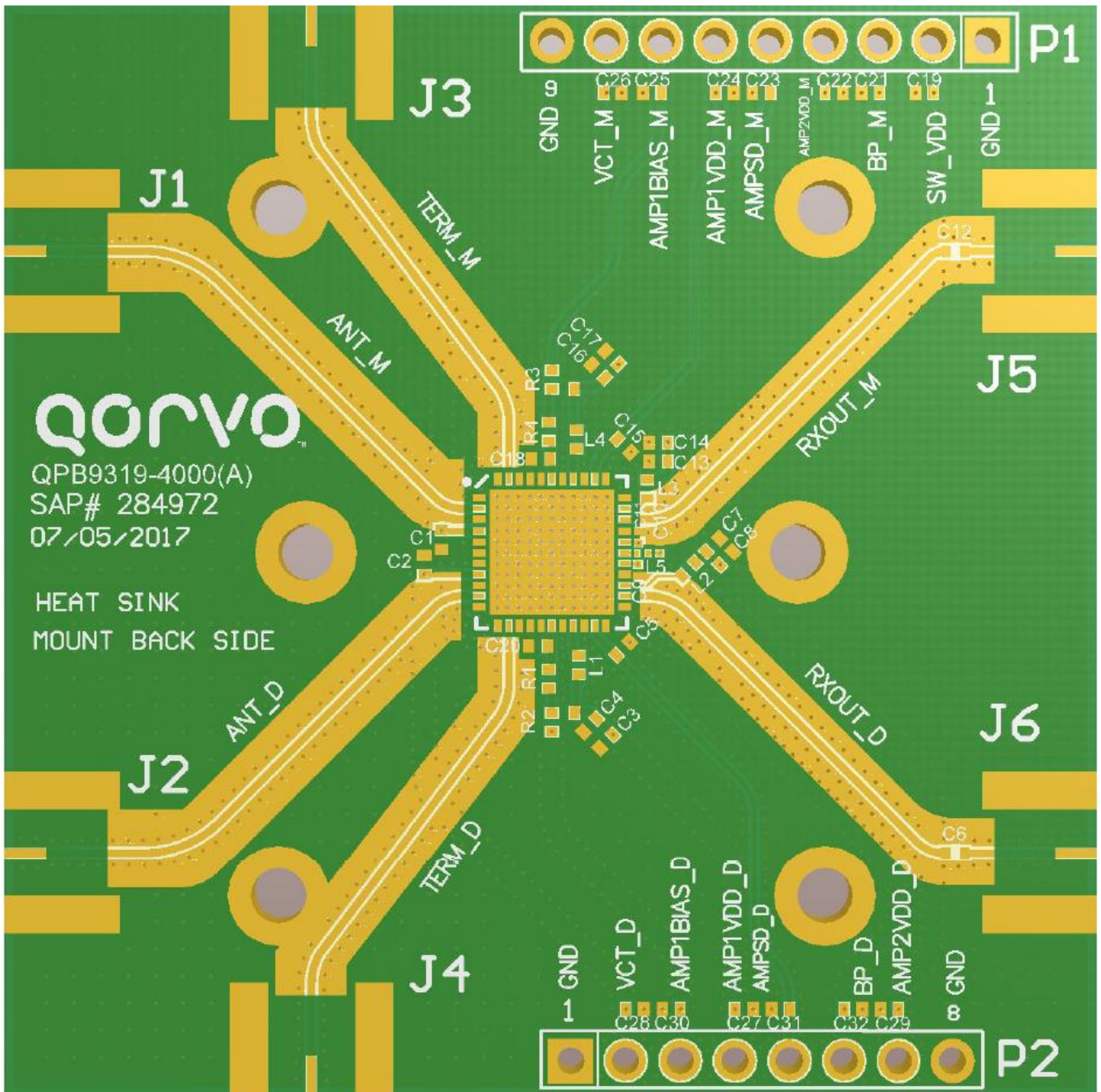

## Performance Plots

Test conditions unless otherwise noted:  $V_{DD} = +5\text{ V}$ , Temp. =  $+25\text{ }^{\circ}\text{C}$

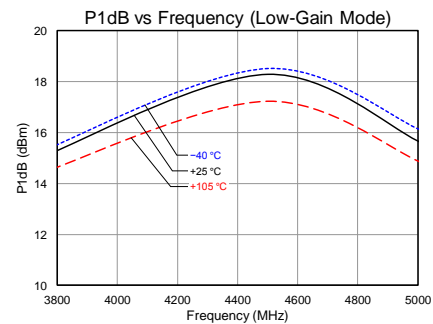
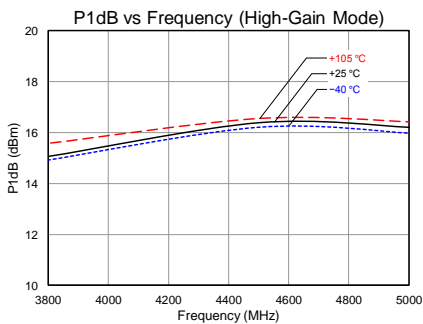
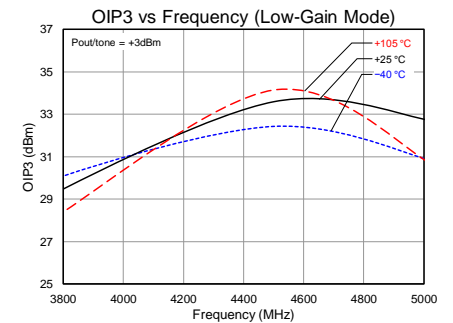
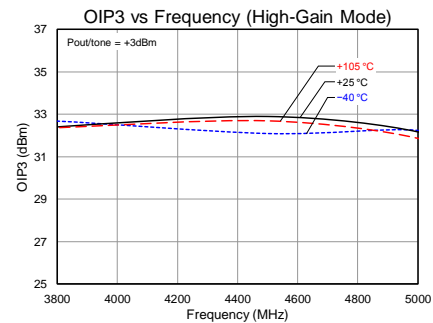
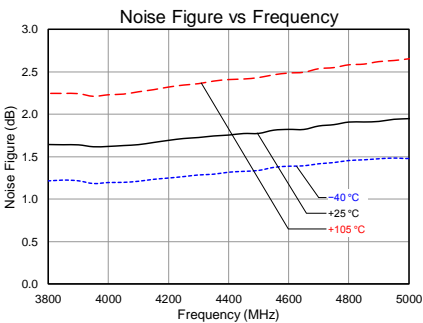
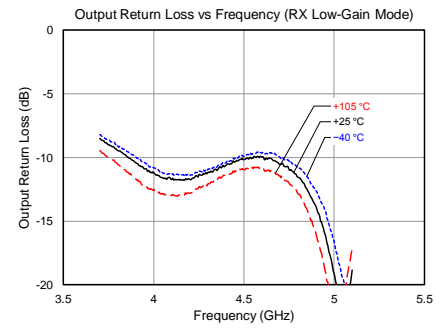
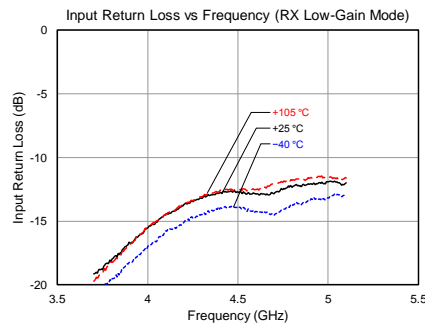
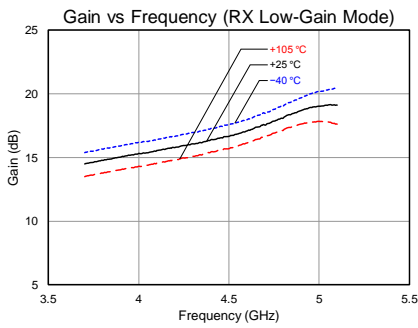
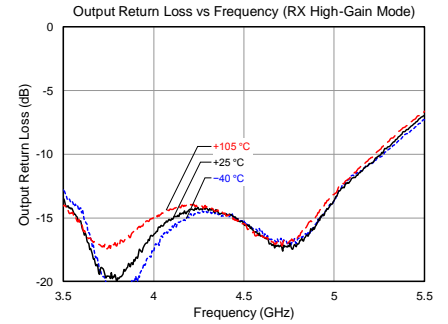
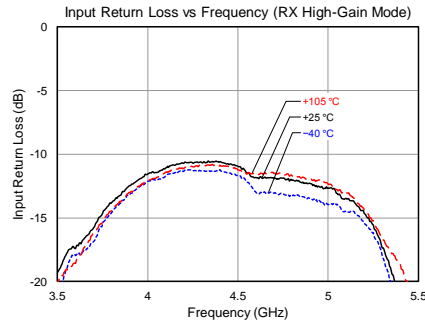
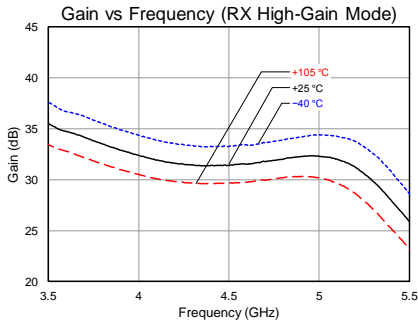

Performance Plots Contd.

Test conditions unless otherwise noted:  $V_{DD} = +5\text{ V}$ , Temp. =  $+25\text{ }^{\circ}\text{C}$

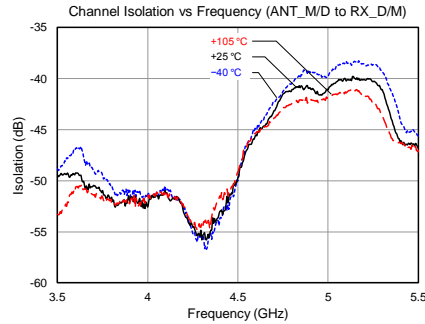
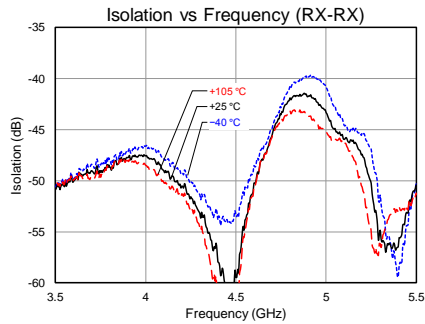
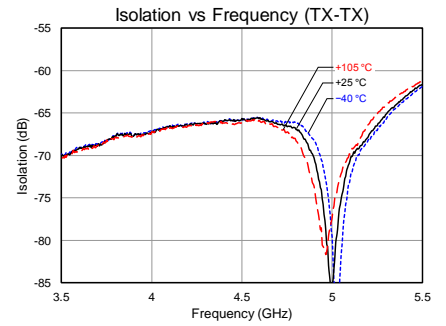
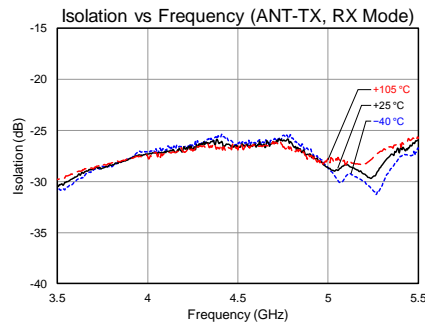
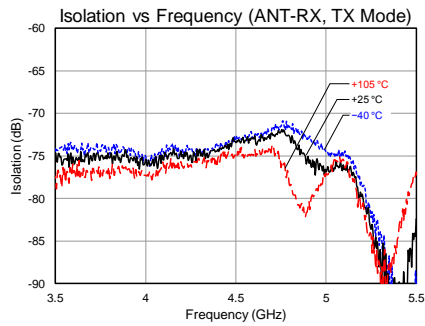
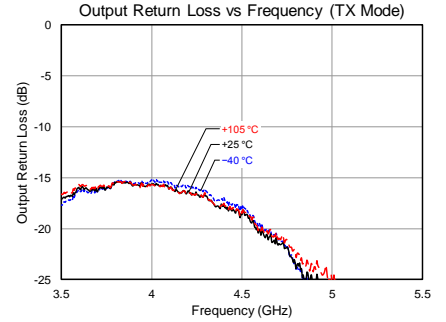
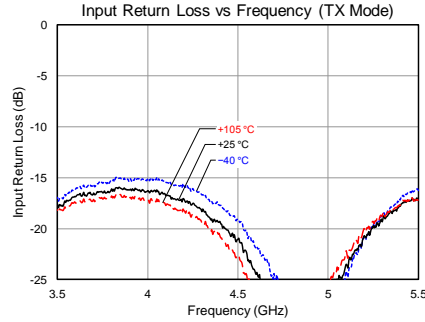
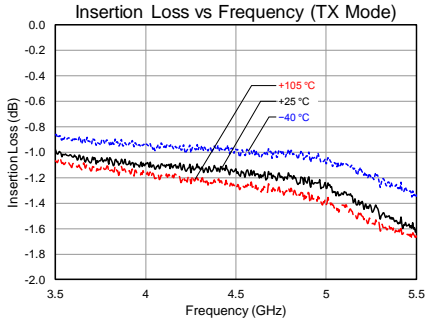

## Pin Configuration and Description

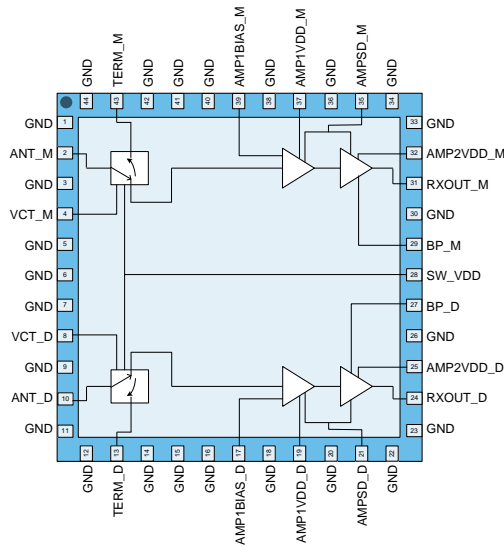

Top View

Pin No.	Label	Description
1, 3, 5, 6, 7, 9, 11, 12, 14, 15, 16, 18, 20, 22, 23, 26, 30, 33, 34, 36, 38, 40, 41, 42, 44	GND	RF/DC ground connection. Recommended to be grounded on PCB to help with isolation and good mounting integrity.
2	ANT_M	Main channel Antenna port of switch.
4	VCT_M	Main channel switch control voltage.
8	VCT_D	Diversity channel switch control voltage.
10	ANT_D	Diversity channel Antenna port of switch.
13	TERM_D	Diversity channel TX or termination port of switch. Switch set to ANT-TERM path can handle 5W average power provided there is a good 50 Ohm load.
17	AMP1BIAS_D	Diversity channel RX path first LNA bias control pin. External series resistor at this pin tied to VDD sets the bias point. Value of resistor can be varied to change current draw.
19	AMP1VDD_D	Diversity channel RX path first LNA supply voltage pin. External choke and bypass caps needed.
21	AMPSD_D	Diversity channel RX path control voltage to turn OFF both AMPs.
24	RXOUT_D	Diversity channel RX path RF output port. External DC block needed.
25	AMP2VDD_D	Diversity channel RX path second LNA supply voltage. External choke and bypass caps needed.
27	BP_D	Diversity channel RX path control voltage to switch second AMP to bypass mode.
28	SW_VDD	Switch DC supply voltage for both channels. External bypass caps recommended.
29	BP_M	Main channel RX path control voltage to switch second AMP to bypass mode.
31	RXOUT_M	Main channel RX path RF output port. External DC block needed.
32	AMP2VDD_M	Main channel RX path second LNA supply voltage. External choke and bypass caps needed.
35	AMPSD_M	Main channel RX path control voltage to turn OFF both AMPs.
37	AMP1VDD_M	Main channel RX path first LNA supply voltage pin. External choke and bypass caps needed.
39	AMP1BIAS_M	Main channel RX path first LNA bias control pin. External series resistor at this pin tied to VDD sets the bias point. Value of resistor can be varied to change current draw.
43	TERM_M	Main channel TX or termination port of switch. Switch set to ANT-TERM path can handle 5W average power provided there is a good 50 Ohm load.
Backside Pad	GND	Ground connection. PCB vias under the device are required. Refer 'PCB Mounting Pattern' on pg. 7.

## Package Marking and Dimensions

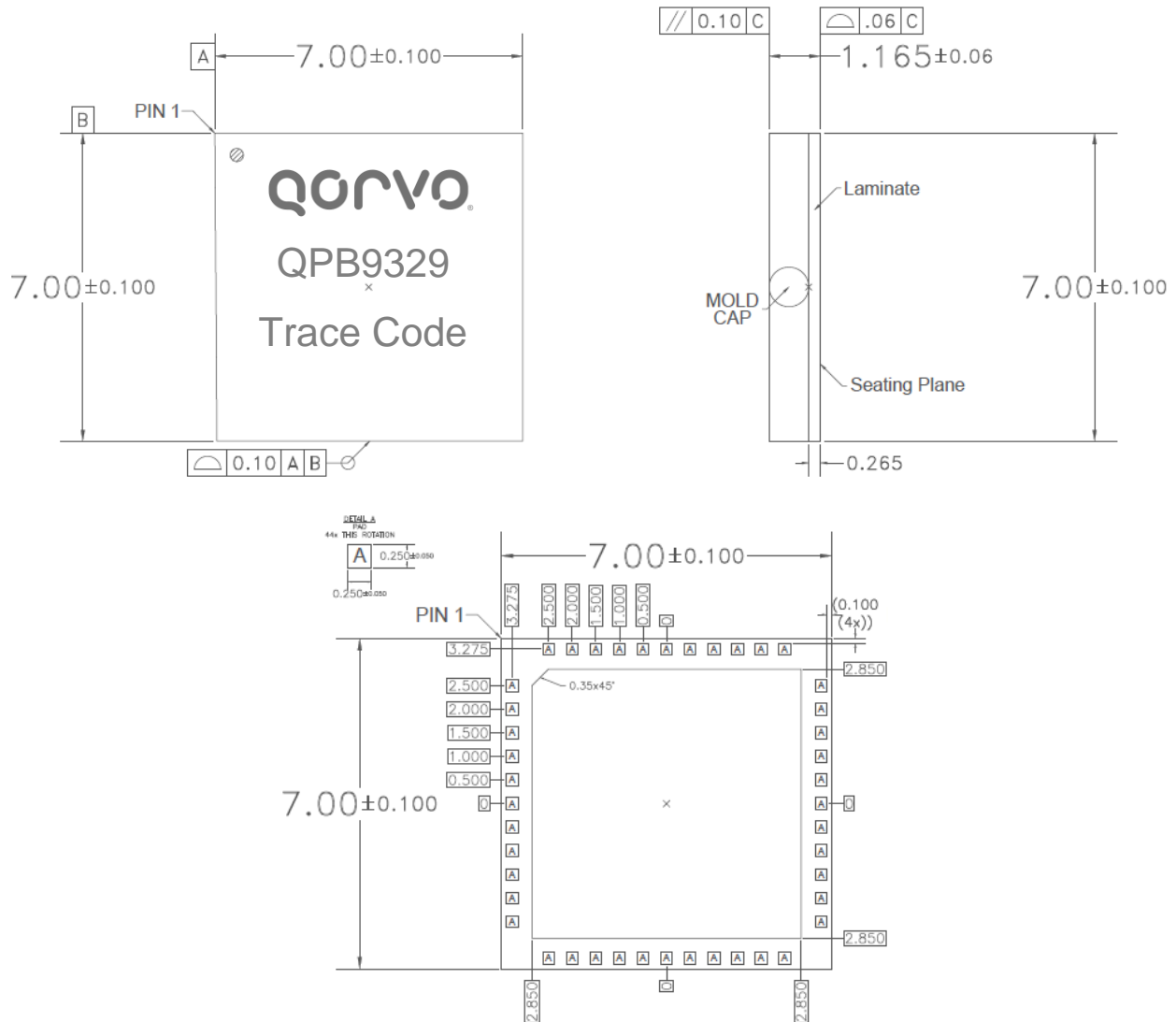

**Notes:**

1. All dimensions are in mm. Angles are in degrees.
2. Dimension and tolerance formats conform to ASME Y14.4M-1994.
3. The terminal #1 identifier and terminal numbering conform to JESD 95-1 SPP-012.



PCB Mounting Pattern

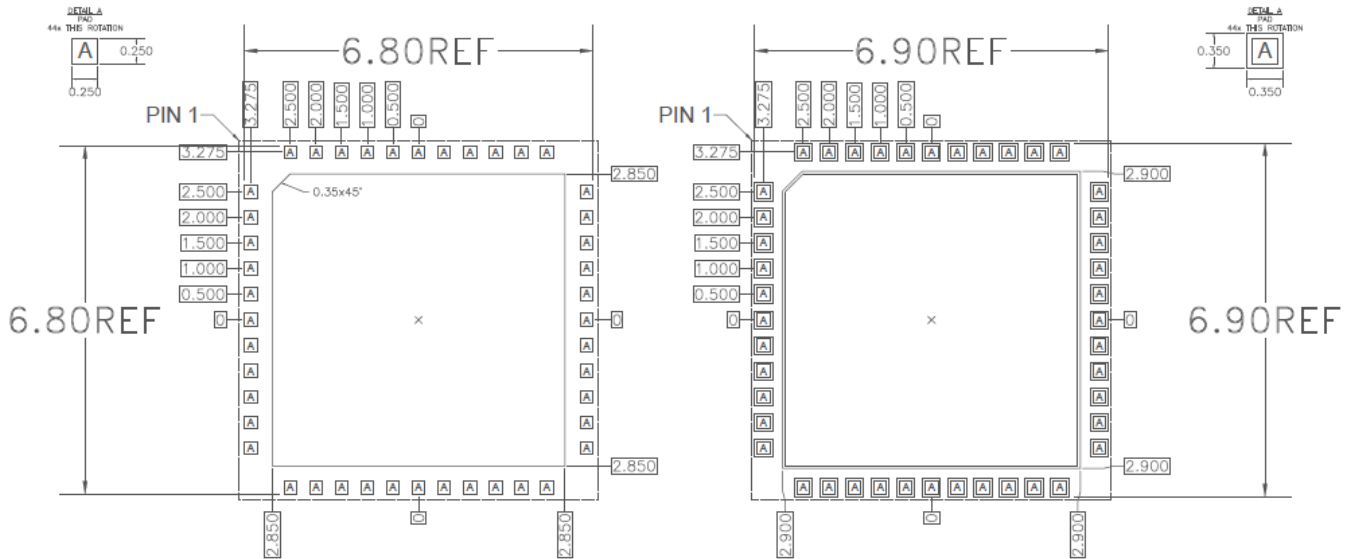

Notes:

1. A heat sink underneath the area of the PCB for the mounted device is recommended for proper thermal operation.
2. Ground / thermal vias are critical for the proper performance of this device. Vias should use a .35mm (#80 / .0135") diameter drill and have a final plated thru diameter of .25 mm (.010").
3. Add as much copper as possible to inner and outer layers near the part to ensure optimal thermal performance.

Tape and Reel Information

CAVITY (mm)				DISTANCE BETWEEN CENTERLINE (mm)		CARRIER TAPE (mm)	COVER TAPE (mm)
Length (A0)	Width (B0)	Depth (K0)	Pitch (P1)	Length direction (P2)	Width Direction (F)	Width (W)	Width (W)
7.50	7.50	1.50	12.0	2.00	7.50	16.0	13.3

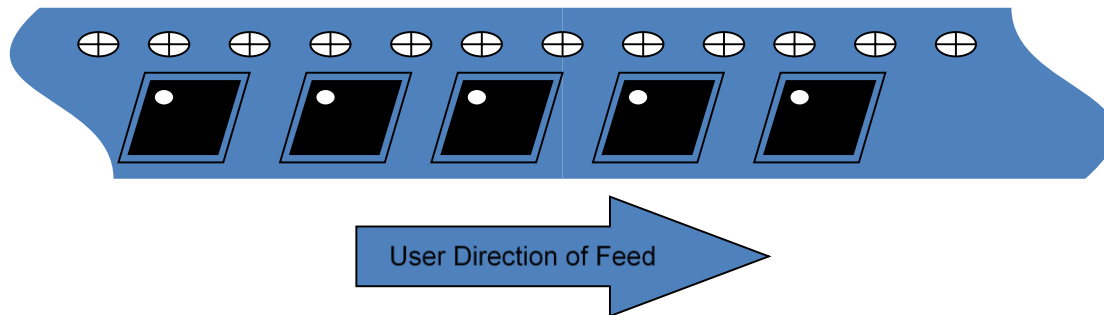
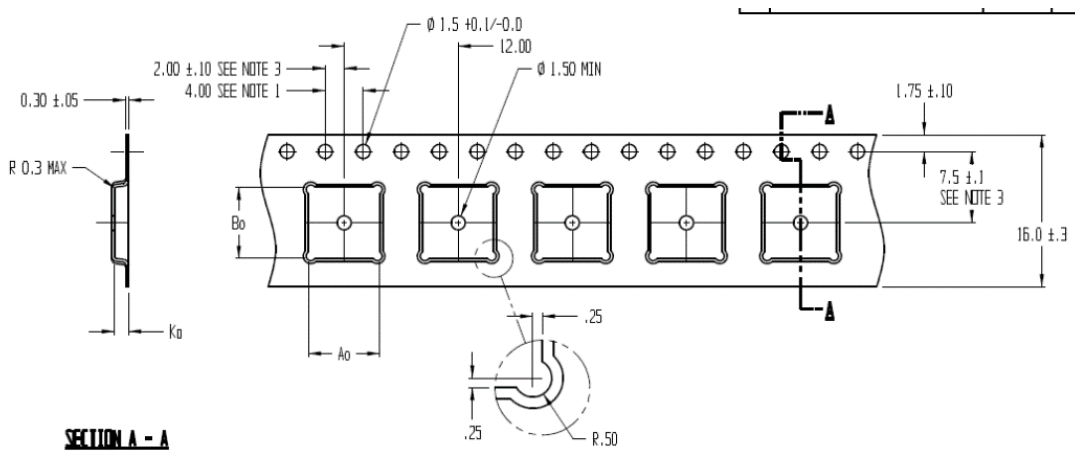

## Handling Precautions

Parameter	Rating	Standard
ESD – Human Body Model (HBM)	Class 1B	ESDA / JEDEC JS-001-2012
ESD – Charged Device Model (CDM)	Class C3	JEDEC JESD22-C101F
MSL – Moisture Sensitivity Level	Level 3	IPC/JEDEC J-STD-020



Caution!  
ESD-Sensitive Device

## Solderability

Compatible with both lead-free (260°C max. reflow temp.) and tin/lead (245°C max. reflow temp.) soldering processes. Solder profiles available upon request.

Contact plating: Electroless Ni and Electroless Pd, immersed in Au

## RoHS Compliance

This part is compliant with the 2011/65/EU RoHS directive (Restrictions on the Use of Certain Hazardous Substances in Electrical and Electronic Equipment) as amended by Directive 2015/863/EU. This product also has the following attributes:

- Product uses RoHS Exemption 7c-I to meet RoHS Compliance requirements.
- Halogen Free (Chlorine, Bromine)
- Antimony Free
- TBBP-A (C<sub>15</sub>H<sub>12</sub>Br<sub>4</sub>O<sub>2</sub>) Free
- PFOS Free
- SVHC Free

## Contact Information

For the latest specifications, additional product information, worldwide sales and distribution locations:

Web: [www.qorvo.com](http://www.qorvo.com)

Tel: 1-844-890-8163

Email: [customer.support@qorvo.com](mailto:customer.support@qorvo.com)

For technical questions and application information: Email: [appsupport@qorvo.com](mailto:appsupport@qorvo.com)

## Important Notice

The information contained herein is believed to be reliable; however, Qorvo makes no warranties regarding the information contained herein and assumes no responsibility or liability whatsoever for the use of the information contained herein. All information contained herein is subject to change without notice. Customers should obtain and verify the latest relevant information before placing orders for Qorvo products. The information contained herein or any use of such information does not grant, explicitly or implicitly, to any party any patent rights, licenses, or any other intellectual property rights, whether with regard to such information itself or anything described by such information. **THIS INFORMATION DOES NOT CONSTITUTE A WARRANTY WITH RESPECT TO THE PRODUCTS DESCRIBED HEREIN, AND QORVO HEREBY DISCLAIMS ANY AND ALL WARRANTIES WITH RESPECT TO SUCH PRODUCTS WHETHER EXPRESS OR IMPLIED BY LAW, COURSE OF DEALING, COURSE OF PERFORMANCE, USAGE OF TRADE OR OTHERWISE, INCLUDING THE IMPLIED WARRANTIES OF MERCHANTABILITY AND FITNESS FOR A PARTICULAR PURPOSE.**

Without limiting the generality of the foregoing, Qorvo products are not warranted or authorized for use as critical components in medical, life-saving, or life-sustaining applications, or other applications where a failure would reasonably be expected to cause severe personal injury or death.

Copyright 2018 © Qorvo, Inc. | Qorvo is a registered trademark of Qorvo, Inc.

Компания «Life Electronics» занимается поставками электронных компонентов импортного и отечественного производства от производителей и со складов крупных дистрибьюторов Европы, Америки и Азии.

С конца 2013 года компания активно расширяет линейку поставок компонентов по направлению коаксиальный кабель, кварцевые генераторы и конденсаторы (керамические, пленочные, электролитические), за счёт заключения дистрибьюторских договоров

Мы предлагаем:

- Конкуренспособные цены и скидки постоянным клиентам.
- Специальные условия для постоянных клиентов.
- Подбор аналогов.
- Поставку компонентов в любых объемах, удовлетворяющих вашим потребностям.
- Приемлемые сроки поставки, возможна ускоренная поставка.
- Доставку товара в любую точку России и стран СНГ.
- Комплексную поставку.
- Работу по проектам и поставку образцов.
- Формирование склада под заказчика.
- Сертификаты соответствия на поставляемую продукцию (по желанию клиента).
- Тестирование поставляемой продукции.
- Поставку компонентов, требующих военную и космическую приемку.
- Входной контроль качества.
- Наличие сертификата ISO.

В составе нашей компании организован Конструкторский отдел, призванный помогать разработчикам, и инженерам.

Конструкторский отдел помогает осуществить:

- Регистрацию проекта у производителя компонентов.
- Техническую поддержку проекта.
- Защиту от снятия компонента с производства.
- Оценку стоимости проекта по компонентам.
- Изготовление тестовой платы монтаж и пусконаладочные работы.



Тел: +7 (812) 336 43 04 (многоканальный)  
Email: [org@lifeelectronics.ru](mailto:org@lifeelectronics.ru)