

**Accessories Miniature Relay PT**

- Easy replacement of relays on a densely packed DIN rail
- No reduction of protection class or creepage/clearance with plastic retainer
- Plug-in indicator- and protection modules
- Retainer clip with ejection function for relays of 29 mm height
- DIN-rail sockets and accessories: RoHS compliant (Directive 2002/95/EC)



F0263-F

**Premium socket with screwless terminals for DIN rail mounting**

**PT 78 74P** Premium socket, logical terminal arrangement, 4 pole  
**PT 78 72P** Premium socket, logical terminal arrangement, 2 pole

- PT 2/4 pole 6/12 A
- Screwless Clamps
- Mounting of solid wires without tool
- Double Clamps per terminal
- Jumper links for interconnection
- Open coil circuit for active modules
- Logical terminal arrangement



F0300-B

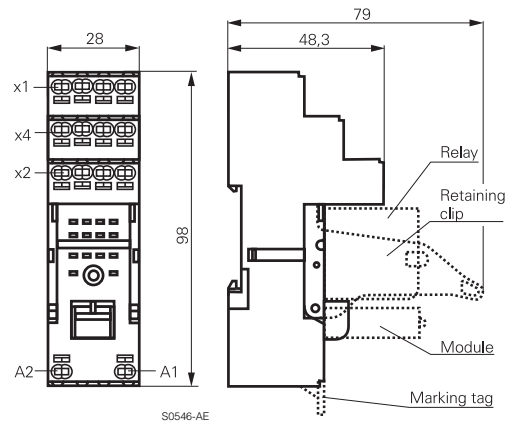

S0546-AE

**Approvals**

VDE REG.-Nr. 115719, c **UL** us E135149

Technical data	2-pole	4-pole
Rated voltage / max. switching voltage AC	240 / 400 VAC	240 VAC
Rated current	12 A	6 A
Limiting continuous current	see derating curve	
Dielectric strength coil-contact circuit	2500 V <sub>rms</sub>	2500 V <sub>rms</sub>
open contact circuit	1200 V <sub>rms</sub>	1200 V <sub>rms</sub>
adjacent contact circuits	2500 V <sub>rms</sub>	2000 V <sub>rms</sub>
Clearance / creepage coil-contact circuit	≥ 4/4 mm	≥ 4/4 mm
adjacent contact circuits	≥ 3.5/9.5 mm	≥ 1.8/3.5 mm
Material group of insulation parts	IIIa	
Insulation to IEC 60664-1		
Type of insulation coil-contact circuit	basic	
open contact circuit	functional	
adjacent contact circuits	basic	
Rated insulation voltage	250 V	
Pollution degree	2 <sup>1)</sup>	
Rated voltage system	230 / 400 V	
Overvoltage category	III	

**Derating curve PT787.P**

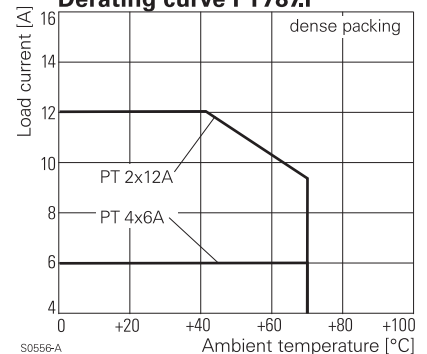

<sup>1)</sup> with inserted relay pollution degree 1 in region of contact pins / socket inlets.

**Accessories Miniature Relay PT (Continued)**

Technical data (Continued)	2-pole	4-pole
RoHS - Directive 2002/95/EC		compliant
Ambient temperature range for mounting/handling in operation	-25...+70°C	-40...+70°C
Terminals		screwless
Wire strip length		12 mm
Wire cross section		
solid wire	1 x 0.75/1/1.5 mm <sup>2</sup>	2 x 0.75/1 mm <sup>2</sup>
with standard isolation (no oversize isolation)	2 x 1.5 mm <sup>2</sup>	
stranded wire		
without bootlace crimp	1 x 0.75/1/1.5 mm <sup>2</sup>	2 x 0.75/1 mm <sup>2</sup>
without bootlace crimp with standard isolation	2 x 1.5 mm <sup>2</sup>	
with bootlace crimp	1 x 0.75/1 mm <sup>2</sup>	2 x 0.75 mm <sup>2</sup>
with bootlace crimp without isolation or min 18 mm long	1 x 1.5 mm <sup>2</sup>	
For stranded wires with braids 0.05 mm or smaller the use of bootlace crimps is recommended. When using stranded wires without bootlace crimp the clamp must be opened during insertion.		
Insertion cycles	A (10)	
Max. Insertion Force total	100 N	
Mounting distance	≥ 0, dense packing	
Weight	44 g	60 g
Packaging unit	10 pcs	

Socket with screwless terminals for DIN rail mounting		
Type		Part Number
<b>PT 7872P</b>	Premium socket, logical terminal arrangement Socket with screwless terminals 2 pole	1860100-1
<b>PT 7874P</b>	Premium socket, logical terminal arrangement Socket with screwless terminals 4 pole	1860000-1

Accessories for PT 78 72P, PT 78 74P		
Type		Part Number
<b>PT 17 021</b>	Plastic retaining clip, relay height 29 mm	2-1415526-1
<b>PT 28 800</b>	Metal retaining clip PT, relay height 29 mm	5-1419111-9
<b>PT 17 040</b>	Marking tag	6-1415037-1
<b>PT 17 0P1</b>	Jumper link, max load 12 A	1860214-1

**How to use, Precautions**

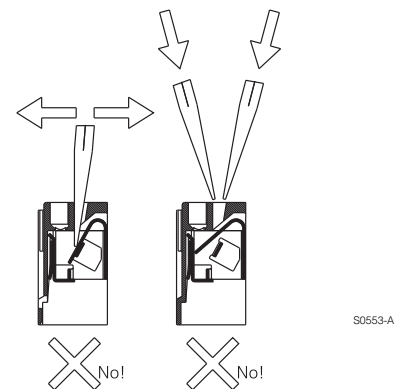
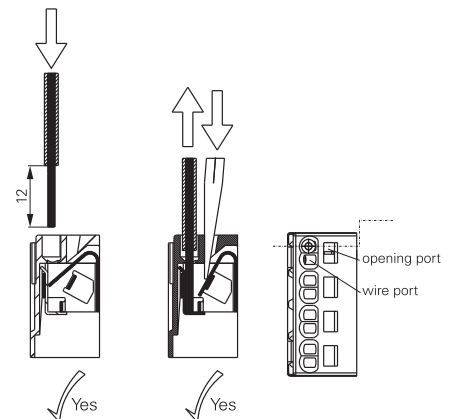
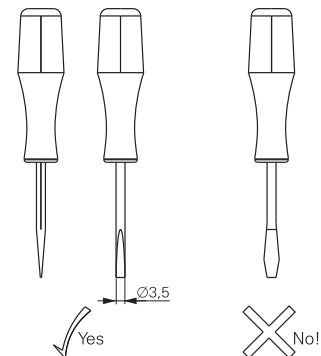

**Jumper link**

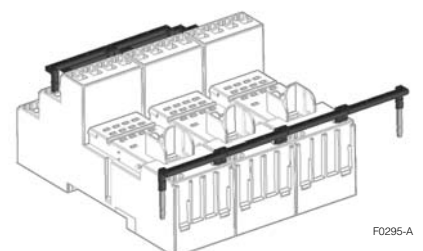

When connecting more than 2 poles with staggered jumper bars the lower bars need to be stripped and shortened to an appropriate length to enable correct fitting.

**Accessories Miniature Relay PT (Continued)**

**PT DIN-rail socket with screw type terminals PT 78 722 / PT 78 742**

- Socket with logical arrangement of control/load terminals
- High quality rising clamp terminals
- Captive combination terminal screws
- Second A2 for easier looping
- Jumper bars for interconnection



F0264-C

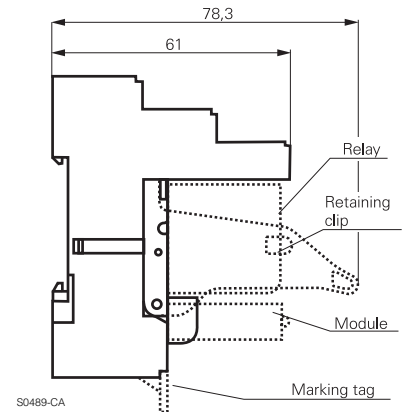
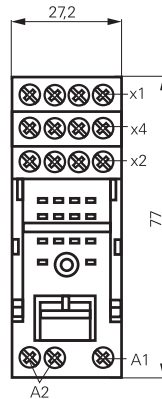

S0489-CA

**Approvals**

VDE REG.-Nr. 115719, cULus E135149

Technical data	2-pole	4-pole
Rated voltage / max. switching voltage AC	240 / 400 VAC	240 VAC
Rated current	12 A	6 A
Limiting continuous current	see derating curve	
Dielectric strength coil-contact circuit	2500 V <sub>rms</sub>	2500 V <sub>rms</sub>
open contact circuit	1200 V <sub>rms</sub>	1200 V <sub>rms</sub>
adjacent contact circuits	2500 V <sub>rms</sub>	2000 V <sub>rms</sub>
Clearance / creepage coil-contact circuit	≥ 4 / 4 mm	≥ 4 / 4 mm
adjacent contact circuits	≥ 3.5 / 9.5 mm	≥ 1.8 / 3.5 mm
Material group of insulation parts	IIIa	
Insulation to IEC 60664-1		
Type of insulation coil-contact circuit	basic	
open contact circuit	functional	
adjacent contact circuits	basic	
Rated insulation voltage	250 V	
Pollution degree	2 <sup>1)</sup>	
Rated voltage system	230 / 400 V	
Overvoltage category	III	
RoHS - Directive 2002/95/EC	compliant	
Ambient temperature range	-40...+70°C	
Terminals	screw	
Terminal screw torque acc. IEC 61984	0.5 Nm	
max.	0.7 Nm	
Wire cross section		
single wire	2 x 2.5 mm <sup>2</sup>	
fine wire	2 x 2.5 mm <sup>2</sup>	
with bootlace crimp (DIN 46228/1)	2 x 1.5 mm <sup>2</sup>	
Insertion cycles	A (10)	
Max. Insertion Force total	100 N	
Mounting distance	≥ 0, dense packing	
Weight	44 g	60 g
Packaging unit	10 pcs	

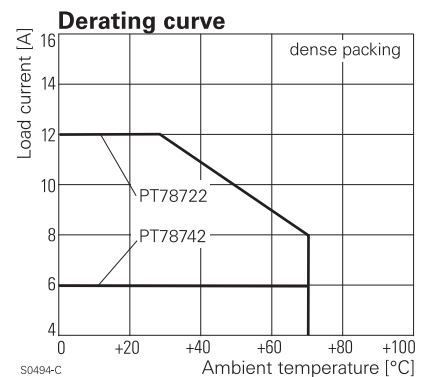

S0494-C

<sup>1)</sup> with inserted relay pollution degree 1 in region of contact pins / socket inlets.

**Accessories Miniature Relay PT (Continued)**

**DIN-rail socket with screw type terminals, In/Out arrangement**

Type		Part Number
<b>PT 78 722</b>	DIN-rail socket with screw type terminals, In/Out arrangement 2 pole	1415526-1
<b>PT 78 742</b>	DIN-rail socket with screw type terminals, In/Out arrangement 4 pole	1-1415526-1

**Accessories for PT 78 722, PT 78 742**

Type		Part Number
<b>PT 17 021</b>	Plastic retaining clip, relay height 29 mm	2-1415526-1
<b>PT 28 800</b>	Metal retaining clip PT, relay height 29 mm	5-1419111-9
<b>PT 17 040</b>	Marking tag	6-1415037-1
<b>PT 17 0R6</b>	Jumper bar, max load 12 A for connection of up to 6 PT sockets	1860517-5

Jumper bar

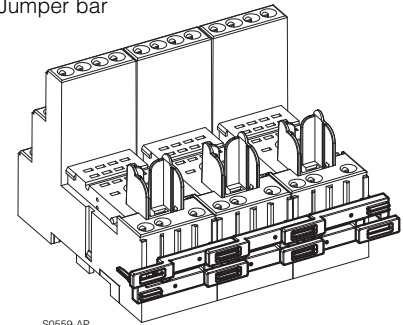

**PT DIN-rail socket with screw type terminals PT 78 720/730/740/741**



F0234-C

S0427-DB

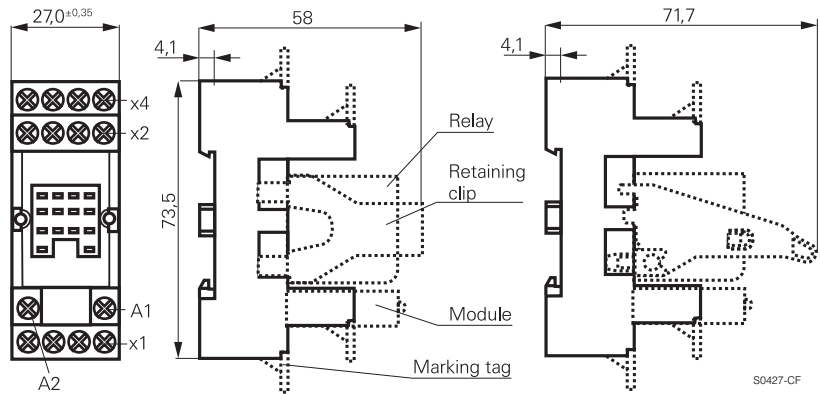

S0427-CF

**Approvals**

VDE REG.-Nr. 115719, cULus E135149

Technical data	2-pole	3-pole	4-pole
Rated voltage / max. switching voltage AC		240 / 400 VAC	
Rated current	12 A	10 A	6 A
Limiting continuous current	see derating curve		
Dielectric strength coil-contact circuit	2500 V <sub>rms</sub>	2500 V <sub>rms</sub>	2500 V <sub>rms</sub>
open contact circuit	1200 V <sub>rms</sub>	1200 V <sub>rms</sub>	1200 V <sub>rms</sub>
adjacent contact circuits	2500 V <sub>rms</sub>	2500 V <sub>rms</sub>	2000 V <sub>rms</sub>
Clearance / creepage coil-contact circuit	≥ 4/4 mm	≥ 4/4 mm	≥ 4/4 mm
adjacent cont. circuits	≥ 3.5/9.5 mm	≥ 2.6/3.5 mm	≥ 1.8/3.5 mm
Material group of insulation parts	IIIa		
Insulation to IEC 60664-1			
Type of insulation coil-contact circuit	basic	basic	basic
open contact circuit	functional	functional	functional
adjacent contact circuits	basic	basic	functional
Rated insulation voltage	250 V		
Pollution degree	2		
Rated voltage system	230 / 400 V		
Overvoltage category	III		
RoHS - Directive 2002/95/EC	compliant		
Ambient temperature range	-40...+70°C		
Terminals	screw		
Terminal screw torque acc. IEC 61984	0.5 Nm		
max.	0.7 Nm		
Wire cross section			
single wire	2 x 2.5 mm <sup>2</sup>		
fine wire	2 x 2.5 mm <sup>2</sup>		
with bootlace crimp (DIN 46228/1)	2 x 1.5 mm <sup>2</sup>		

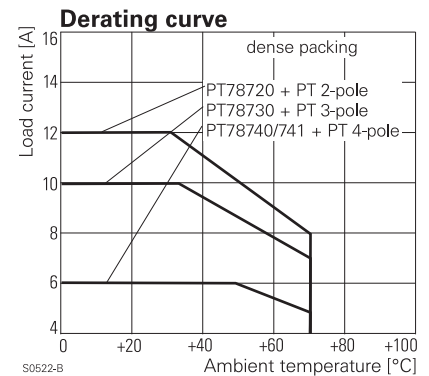

S0522-B

**Accessories Miniature Relay PT (Continued)**

Technical data (Continued)	2-pole	3-pole	4-pole
Insertion cycles		A (10)	
Max. Insertion Force total		100 N	
Mounting distance	≥ 0, dense packing		
Weight	41 g	48 g	55 g
Packaging unit	10 pcs		

**DIN-rail socket with screw type terminals**

Type		Part Number
<b>PT 78 720</b>	DIN-rail socket with screw type terminals, 2 pole	6-1415034-1
<b>PT 78 730</b>	DIN-rail socket with screw type terminals, 3 pole	9-1415071-1
<b>PT 78 740</b>	DIN-rail socket with screw type terminals, 4 pole	4-1415033-1
<b>PT 78 741</b>	DIN-rail socket with screw type terminals, 4 pole package with protection diode module A1+, A2-	5-1415034-1

**Accessories for PT 78 720, PT 78 730, PT 78 740, PT 78 741**

Type		Part Number
<b>PT 17 016</b>	Plastic retaining clip PT, relay height 29 mm	5-1415037-1
<b>PT 17 024</b>	Plastic retaining clip PT with ejecting function, relay height 29 mm	1816124-1
<b>PT 28 800</b>	Metal retaining clip PT, relay height 29 mm	5-1419111-9
<b>PT 17 040</b>	Marking tag	6-1415037-1
<b>PT 17 0R6</b>	Jumper bar, max load 12 A for connection of up to 6 PT sockets	1860517-5

**LED- and Protection Modules for PT 78 72P, PT 78 74P, PT 78 722, PT 78 742, PT 78 720, PT 78 730, PT 78 740**

Easy insertion of module into the socket  
Wiring in parallel to the coil

Type		Part Number
<b>PTM T0 0A0</b>	EM09 Protection diode (standard, A1+, A2-)	9-1415036-1
<b>PTM T0 0L0</b>	EM01 Protection diode (A1-, A2+)	1415037-1
<b>PTM U0 524</b>	EM02 RC-network 6...60 VAC	1-1415037-1
<b>PTM U0 730</b>	EM03 RC-network 110...230 VAC	2-1415037-1
<b>PTM V0 524</b>	EM04 Varistor 24 VAC	3-1415037-1
<b>PTM V0 615</b>	EM13 Varistor 115 VAC	6-1415365-1
<b>PTM V0 730</b>	EM05 Varistor 230 VAC	4-1415037-1
<b>PTM D0 730</b>	EM31 Residual current bypass RC 110...230 VAC	1415037-2
<b>PTM R0 730</b>	EM29 Residual current bypass resistor 110...230 VAC	1-1415539-2

**LED**

<b>PTM L0 024</b>	EM18 red LED 6...24 VDC w. prot.diode (std, A1+, A2-)	5-1415036-1
<b>PTM G0 024</b>	EM12 green LED 6...24 VDC w. prot.diode (std, A1+, A2-)	2-1415036-1
<b>PTM L1 024</b>	EM08 red LED 6...24 VDC w. prot. diode (A1-, A2+)	8-1415036-1
<b>PTM L0 060</b>	EM16 red LED 24...60 VDC w. prot.diode (std, A1+, A2-)	5-1415539-3
<b>PTM G0 060</b>	EM25 green LED 24...60 VDC w. prot.diode (std, A1+, A2-)	7-1415539-7
<b>PTM L0 110</b>	EM19 red LED 60...110 VDC w. prot. diode (A1+, A2-)	2-1415392-1
<b>PTM G0 110</b>	EM26 green LED 60...110 VDC w. prot diode (A1+, A2-)	1-1415539-7
<b>PTM L0 220</b>	EM27 red LED 110...220 VDC w. prot. diode (A1+, A2-)	1-1415539-4
<b>PTM G0 220</b>	EM28 green LED 110...220 VDC w. prot diode (A1+, A2-)	1-1415539-6
<b>PTM L0 524</b>	EM07 red LED 6...24 VDC/VAC	6-1415036-1
<b>PTM G0 524</b>	EM11 green LED 6...24 VDC/VAC	3-1415036-1
<b>PTM L0 560</b>	EM14 red LED 24...60 VDC/VAC	1-1415539-3
<b>PTM G0 560</b>	EM30 green LED 24...60 VDC/VAC	1-1415539-5
<b>PTM L0 730</b>	EM06 red LED 110...230 VAC	7-1415036-1
<b>PTM G0 730</b>	EM10 green LED 110...230 VAC	4-1415036-1

**Relay Packages**

Complete packages consisting of a relay mounted on a socket: see Relay Package PT

PT17 016

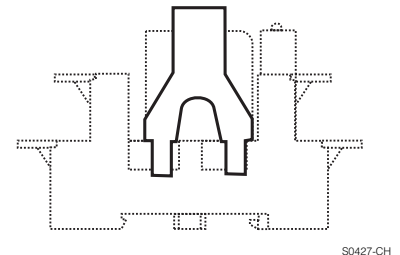

S0427-CH

PT17 024

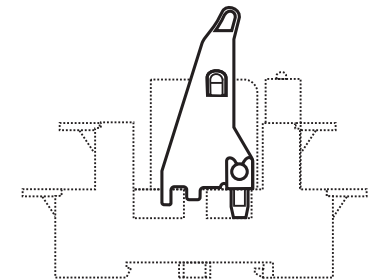

S0427-CI

**Marking tags**

- White marking area 28 x 6 mm
- Snaps on socket in up to 4 positions



F0231-A



F0232-A

**Accessories Miniature Relay PT (Continued)**

**PT sockets for PCB mount and with solder terminals**

**PT 78 600**, socket with solder terminals, 4-pole



F0132-A

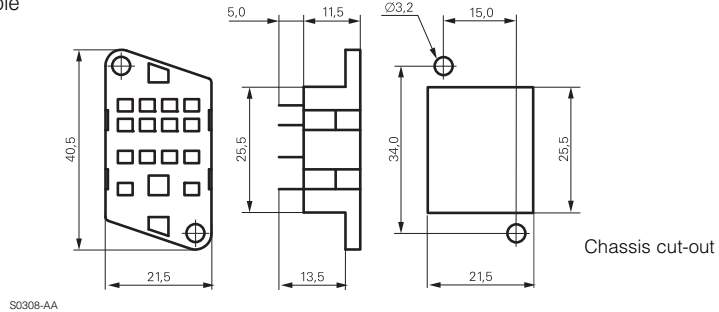

Chassis cut-out

**PT 78 602, PT 78 603, PT 78 604**, socket with PCB terminals, 2-, 3- and 4-pole



F0133-A

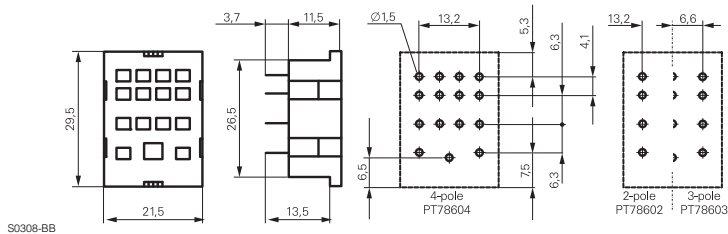

**PT 78 601**, socket with solder terminals, 4-pole



F0134-A

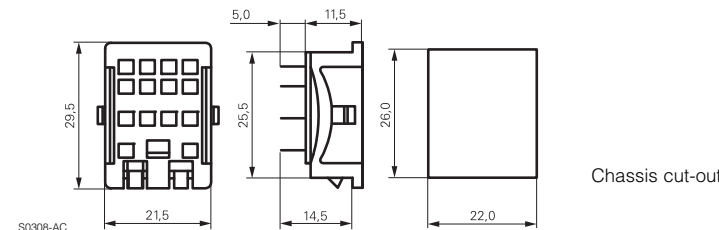

Chassis cut-out

Technical data	2-pole	3-pole	4-pole
Rated voltage / max. switching voltage AC		240 / 400 VAC	
Rated current	12 A	10 A	6 A
Dielectric strength coil-contact circuit	2500 V <sub>rms</sub>	2500 V <sub>rms</sub>	2500 V <sub>rms</sub>
open contact circuit	1200 V <sub>rms</sub>	1200 V <sub>rms</sub>	1200 V <sub>rms</sub>
adjacent contact circuits	2500 V <sub>rms</sub>	2500 V <sub>rms</sub>	2000 V <sub>rms</sub>
Clearance / creepage coil-contact circuit	≥ 4/4 mm	≥ 4/4 mm	≥ 4/4 mm
adjacent cont. circuits	≥ 3.5/9.5 mm	≥ 2.6/3.5 mm	≥ 1.8/3.5 mm
Material group of insulation parts	IIIa		
Insulation to IEC 60664-1			
Type of insulation coil-contact circuit	basic	basic	basic
open contact circuit	functional	functional	functional
adjacent contact circuits	basic	basic	functional
Rated insulation voltage	250 V		
Pollution degree	2		
Rated voltage system	230 / 400 V		
Overtoltage category	III		

**Accessories Miniature Relay PT** (Continued)

Technical data (Continued)	2-pole	3-pole	4-pole
RoHS - Directive 2002/95/EC	compliant as per product date code 0517		
Ambient temperature range	-40...+80°C		
Terminals	pcb, solder terminals		
Insertion cycles	A (10)		
Max. Insertion Force total	100 N		
Mounting distance	≥ 0, dense packing		
Resistance to soldering heat	270°C / 10 s		
Weight	6 g	7 g	7 g
Packaging unit	25 pcs		

**PT sockets**

Type	Part Number
<b>PT 78 600</b> Socket with solder terminals, 4 pole	4-1415043-1
<b>PT 78 602</b> Socket with PCB terminals, 2 pole	5-1415043-1
<b>PT 78 603</b> Socket with PCB terminals, 3 pole	1393162-5
<b>PT 78 604</b> Socket with PCB terminals, 4 pole	3-1415043-1
<b>PT 78 601</b> Socket with solder terminals, 4 pole	6-1415043-1

**Accessories for PT 78 600, PT 78 601, PT 78 602, PT 78 603, PT 78 604**

Type	Part Number
<b>PT 28 802</b> Metal retaining clip PT, relay height 29 mm	1393162-1



Компания «Life Electronics» занимается поставками электронных компонентов импортного и отечественного производства от производителей и со складов крупных дистрибьюторов Европы, Америки и Азии.

С конца 2013 года компания активно расширяет линейку поставок компонентов по направлению коаксиальный кабель, кварцевые генераторы и конденсаторы (керамические, пленочные, электролитические), за счёт заключения дистрибьюторских договоров

Мы предлагаем:

- Конкурентоспособные цены и скидки постоянным клиентам.
- Специальные условия для постоянных клиентов.
- Подбор аналогов.
- Поставку компонентов в любых объемах, удовлетворяющих вашим потребностям.
- Приемлемые сроки поставки, возможна ускоренная поставка.
- Доставку товара в любую точку России и стран СНГ.
- Комплексную поставку.
- Работу по проектам и поставку образцов.
- Формирование склада под заказчика.
- Сертификаты соответствия на поставляемую продукцию (по желанию клиента).
- Тестирование поставляемой продукции.
- Поставку компонентов, требующих военную и космическую приемку.
- Входной контроль качества.
- Наличие сертификата ISO.

В составе нашей компании организован Конструкторский отдел, призванный помогать разработчикам, и инженерам.

Конструкторский отдел помогает осуществить:

- Регистрацию проекта у производителя компонентов.
- Техническую поддержку проекта.
- Защиту от снятия компонента с производства.
- Оценку стоимости проекта по компонентам.
- Изготовление тестовой платы монтаж и пусконаладочные работы.



Тел: +7 (812) 336 43 04 (многоканальный)

Email: [org@lifeelectronics.ru](mailto:org@lifeelectronics.ru)