



7.0 x 5.0 x 1.9mm

AST3TQ



ESD Sensitive



RoHS/RoHS II Compliant

Moisture Sensitivity Level (MSL) – 3

➤ **FEATURES:**

- Standard available frequencies: 10.00, 12.80, 19.20, 20.00, 25.00, 26.00, 30.72, 38.40 & 40.00MHz
- Standard LVCMOS Output
- Frequency stabilities to include ± 100 ppb over -40°C to $+85^{\circ}\text{C}$, ± 280 ppb over -50°C to $+90^{\circ}\text{C}$ and ± 500 ppb over -55°C to $+95^{\circ}\text{C}$ operating temperature range
- Excellent Phase Noise, Harmonics and Spurious content
- Typical rms jitter of 400fs @ 40MHz carrier & 1.0ps @ 10MHz carrier over 12kHz to 20MHz BW

➤ **APPLICATIONS:**

- COTS Military Radios & other Communication Hardware
- WiMax,
- LTE, BTS
- CATV, LAN, LMDS
- GPS Tracking with Hold-Over accuracy
- Test & Measurement Equipment
- Point-to-Point communication networks

➤ **STANDARD SPECIFICATIONS:**

Maximum Rating

Parameters	Rating
Storage Temperature Range	-55 to +125°C
Supply Voltage	-0.5 to 6V
ESD, HBM/CDM/MM	4k V/2k V/200V

Parameters	Minimum	Typical	Maximum	Units	Notes
Frequency Range	10		40	MHz	
Standard Frequencies:	10.00, 12.80, 19.20, 20.00, 25.00, 26.00, 30.72, 38.40, 40.00			MHz	
Initial Frequency Tolerance (@+25°C) at shipping			± 0.3	ppm	Relative to carrier
Frequency Stability Options					
-40°C to +85°C			± 100	ppb	Option "1"
-50°C to +90°C			± 280	ppb	Option "2"
-55°C to +95°C			± 500	ppb	Option "5"
Frequency Stability vs. Supply Voltage Change (V _{dd} ±5%):			± 100	ppb	
Frequency Stability vs. Load Change (Load±5%):			± 200	ppb	
Supply Voltage (V _{dd}):	+3.135	+3.3	+3.465	V	
Aging (first year @+25°C):			± 1.0	ppm	
Aging (20 years @+25°C):		± 3.0	± 4.6	ppm	
Supply Current (I _{cc}) (into 15pF load):		3.0	4.0	mA	@10MHz carrier
			5.5		7.0
CMOS Output					
V _{OH} :	2.4			V	Load=15pF
V _{OL} :			0.4	V	Load=15pF
Load:			15	pF	
Duty Cycle:	45		55	%	@(V _{OH} - V _{OL})/2
Rise/Fall Time:			4	ns	Load=15pF
Waveform:	Square Wave				
RMS Jitter (12kHz to 20MHz BW)	0.4		1.3	ps	Carrier dependent
Phase Noise (10MHz carrier frequency @25°C):			-95	dBc/Hz	Offset @10Hz
			-120		Offset @100Hz
			-140		Offset @1kHz
			-145		Offset @10kHz
			-150		Offset @100kHz



7.0 x 5.0 x 1.9mm

AST3TQ

RoHS/RoHS II Compliant

OPTIONS & PART IDENTIFICATION: (left blank if standard)

AST3TQ - MHz - -

Frequency in MHz
Please specify the frequency in MHz.
e.g. 19.200MHz

Freq. Stability vs. Operating Temp.
1: ±100ppb over -40 to +85°C
2: ±280ppb over -50 to +90°C
5: ±500ppb over -55 to +95°C

Packaging
Blank: Bulk
T: 500pcs/reel
T2: 2000pcs/reel

FREQUENCY STABILITY VS. TEMPERATURE

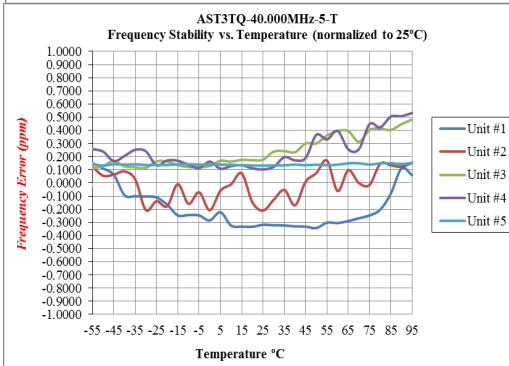
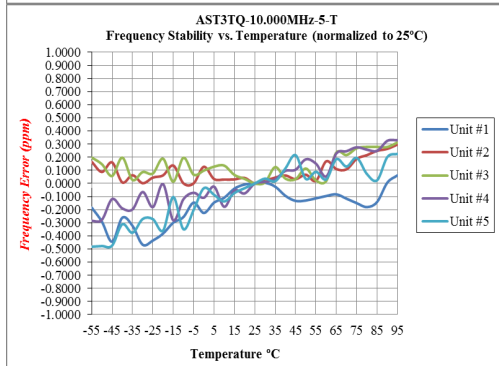
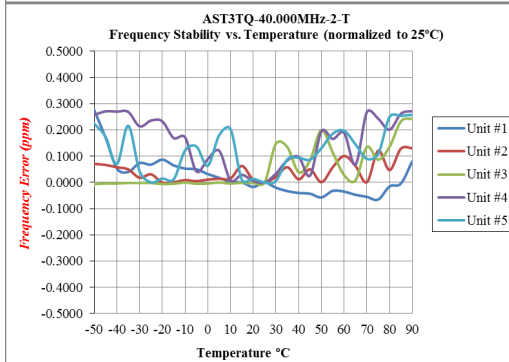
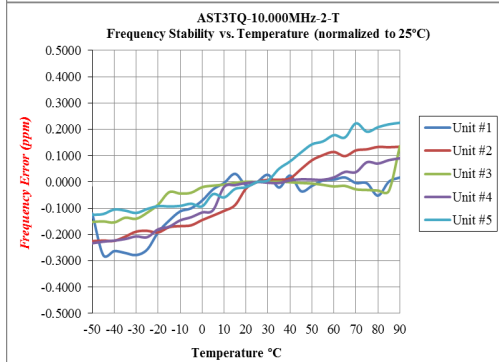
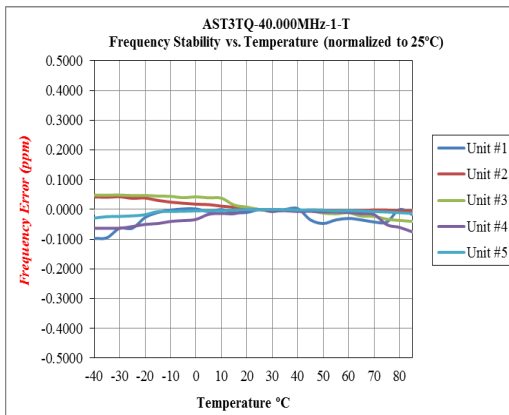
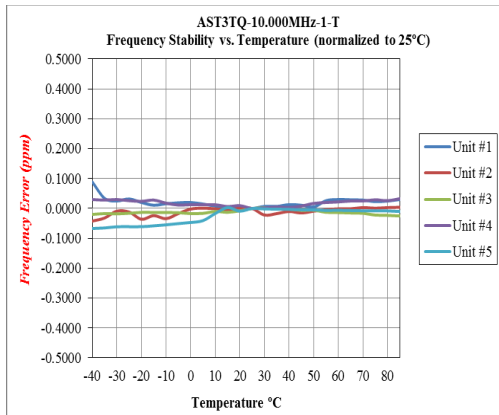



7.0 x 5.0 x 1.9mm

AST3TQ

RoHS/RoHS II Compliant

TYPICAL PHASE NOISE

10.00 MHz Carrier

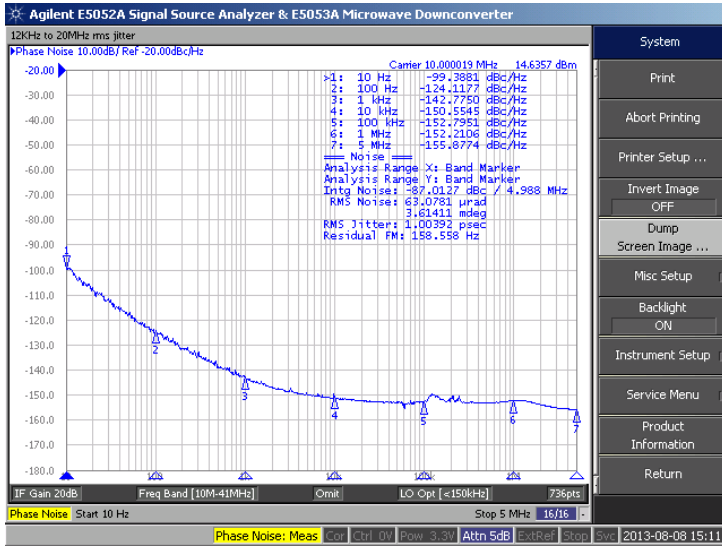

20.00 MHz Carrier

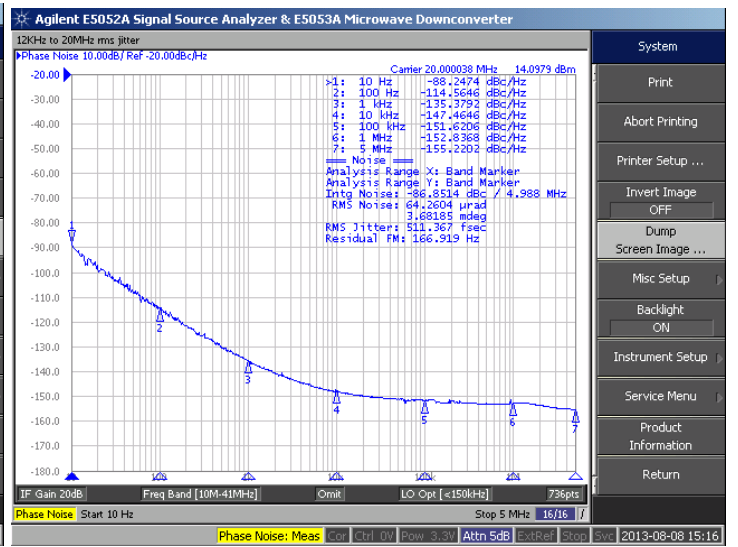

40.00 MHz Carrier

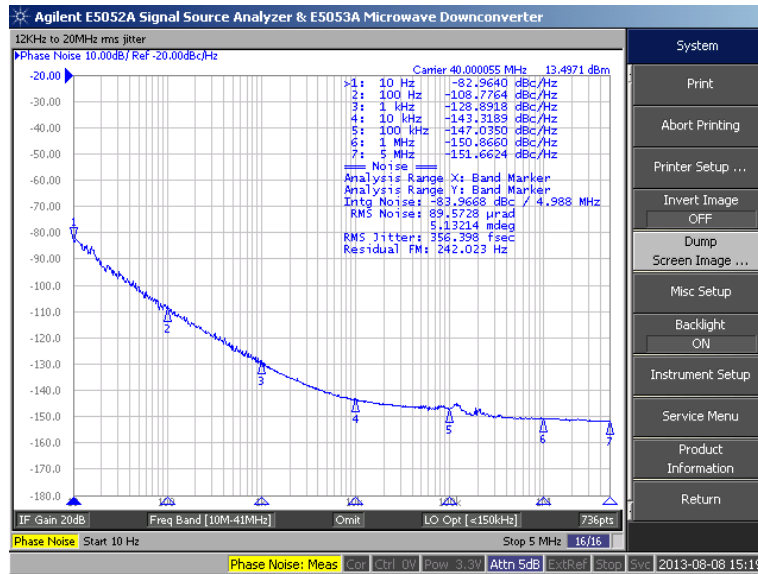



7.0 x 5.0 x 1.9mm

AST3TQ

RoHS/RoHS II Compliant

OUTLINE DIMENSION:

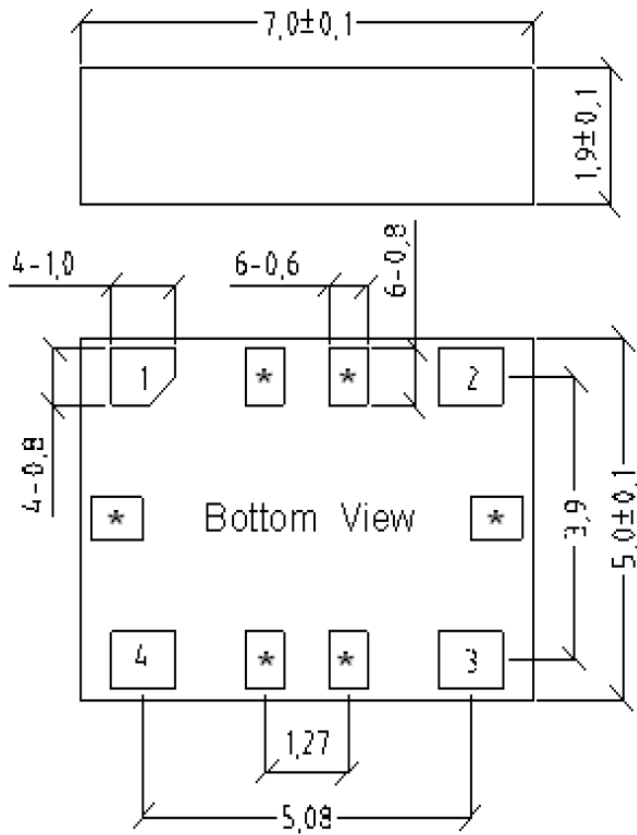

Recommended Land Pattern

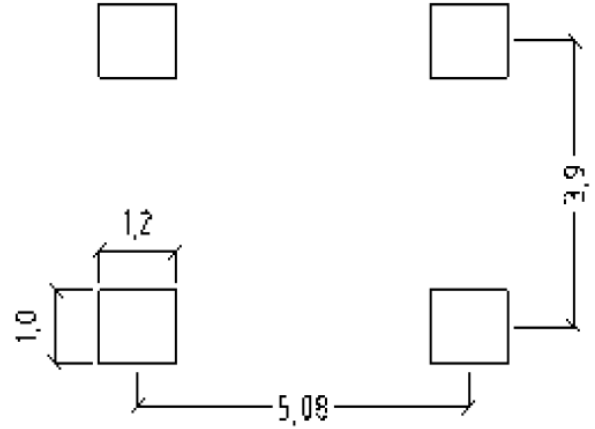

Pin	Function
1	NC
2	GND
3	Output
4	Vdd
*	For factory test only

Dimensions: mm

REFLOW PROFILE:

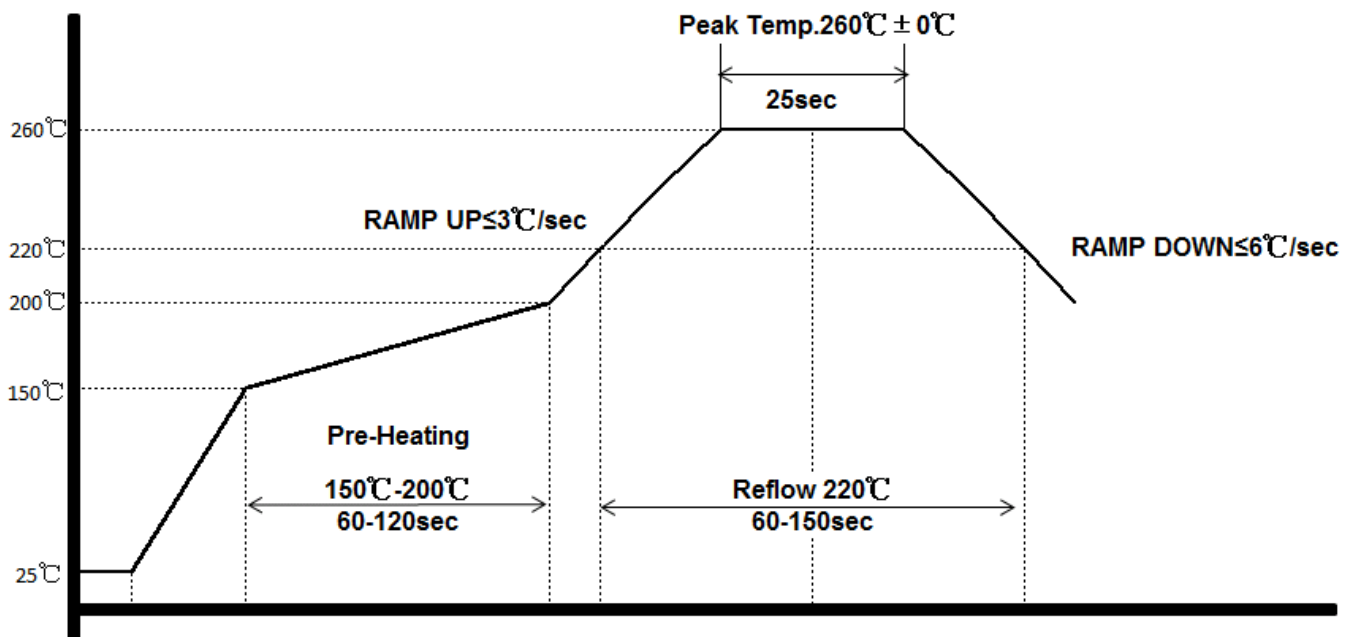



7.0 x 5.0 x 1.9mm

AST3TQ

RoHS/RoHS II Compliant

TAPE & REEL:

Packaging:

T: 500pcs/reel

T2: 2000pcs/reel

MSL-3 packaging applies to MOQ=25 units (cut tape) & T and T2.

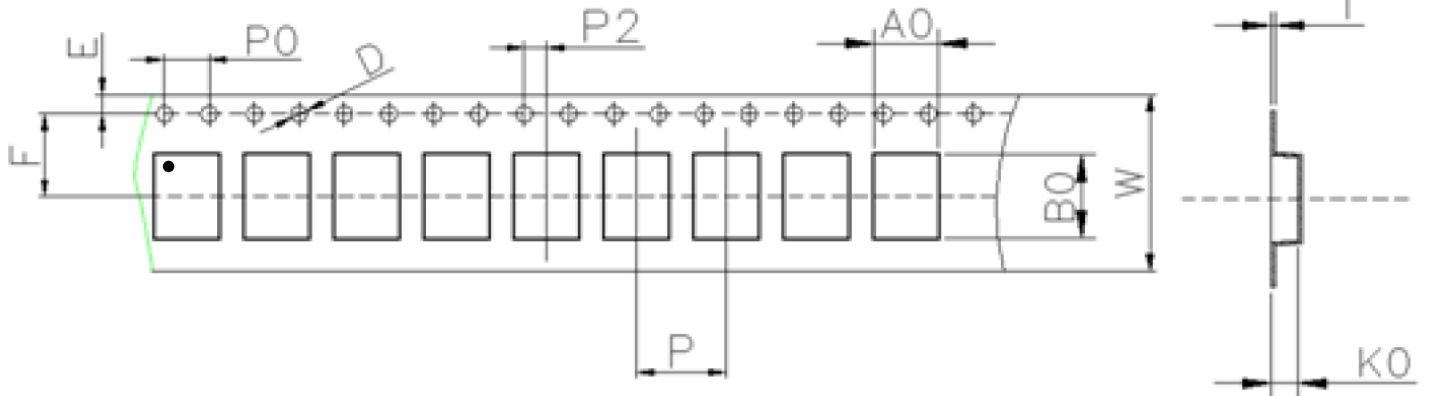

W	A0	B0	K0	P	F
16.0±0.3	5.7±0.15	7.6±0.15	2.4±0.15	8.0±0.1	7.5±0.1
E	D	P0	P2	T	
1.75±0.1	1.5+0.1/-0.0	4.0±0.1	2.0±0.1	0.3±0.05	

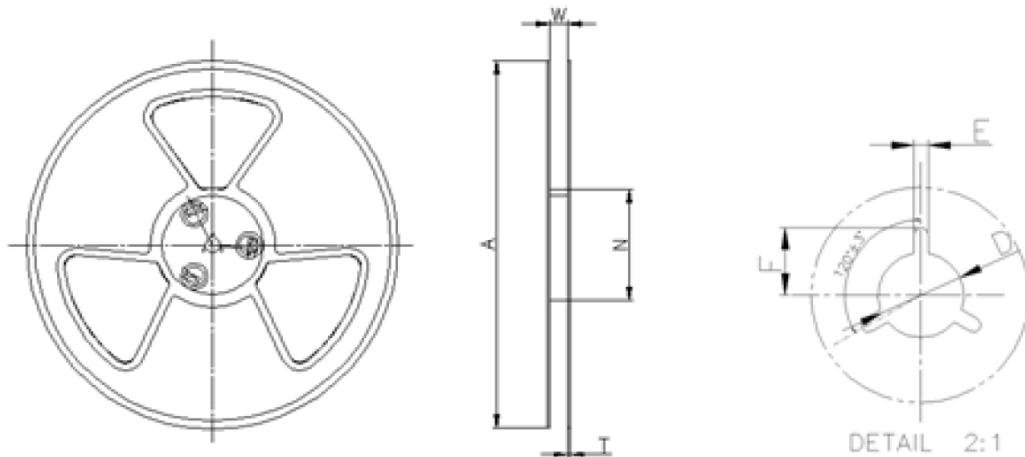

W	A	N	T	E	F	D
16.5±0.4	330±0.5	100±0.3	1.8±0.2	2.1±0.3	10.75±0.3	13.5+0.5/-0.2

Dimensions: mm

ATTENTION: Abracon Corporation's products are COTS – Commercial-Off-The-Shelf products; suitable for Commercial, Industrial and, where designated, Automotive Applications. Abracon's products are not specifically designed for Military, Aviation, Aerospace, Life-dependant Medical applications or any application requiring high reliability where component failure could result in loss of life and/or property. For applications requiring high reliability and/or presenting an extreme operating environment, written consent and authorization from Abracon Corporation is required. Please contact Abracon Corporation for more information.

Компания «Life Electronics» занимается поставками электронных компонентов импортного и отечественного производства от производителей и со складов крупных дистрибьюторов Европы, Америки и Азии.

С конца 2013 года компания активно расширяет линейку поставок компонентов по направлению коаксиальный кабель, кварцевые генераторы и конденсаторы (керамические, пленочные, электролитические), за счёт заключения дистрибьюторских договоров

Мы предлагаем:

- Конкуренспособные цены и скидки постоянным клиентам.
- Специальные условия для постоянных клиентов.
- Подбор аналогов.
- Поставку компонентов в любых объемах, удовлетворяющих вашим потребностям.
- Приемлемые сроки поставки, возможна ускоренная поставка.
- Доставку товара в любую точку России и стран СНГ.
- Комплексную поставку.
- Работу по проектам и поставку образцов.
- Формирование склада под заказчика.
- Сертификаты соответствия на поставляемую продукцию (по желанию клиента).
- Тестирование поставляемой продукции.
- Поставку компонентов, требующих военную и космическую приемку.
- Входной контроль качества.
- Наличие сертификата ISO.

В составе нашей компании организован Конструкторский отдел, призванный помогать разработчикам, и инженерам.

Конструкторский отдел помогает осуществить:

- Регистрацию проекта у производителя компонентов.
- Техническую поддержку проекта.
- Защиту от снятия компонента с производства.
- Оценку стоимости проекта по компонентам.
- Изготовление тестовой платы монтаж и пусконаладочные работы.



Тел: +7 (812) 336 43 04 (многоканальный)

Email: org@lifeelectronics.ru