

Kxxx0yH Series

RoHS



Schematic Symbol



Description

The new Kxxx0yH is a higher energy SIDAC switch for gas ignition applications requiring higher current pulse current especially at low repetition rate. It is offered in a DO-15 and TO-92 leaded packages as well as DO-214 surface mount package. Voltage activation of this solid state switch is accomplished with peak voltage level of 190 to 280Volts. The SIDAC is a silicon bilateral voltage triggered Thyristor switch that switches on through a negative resistance region to a low on-state voltage. Conduction will continue until current is interrupted or lowered below minimum holding current of the device.

Features

- AC Circuit Oriented
- 280A Pulse Current Capability
- Triggering Voltage of 190 to 280V
- RoHS Compliant

Applications

Suitable for high voltage power supplies, natural gas igniters, and Xenon flash ignition.

Electrical Specifications (T<sub>j</sub> = 25°C, unless otherwise specified)

Symbol	Parameters	Test Conditions	Min	Max	Unit
V <sub>BO</sub>	Breakover/Trigger Voltage	K2000yH	190	215	V
		K2200yH	205	230	
		K2400yH	220	250	
		K2500yH	240	280	
V <sub>DRM</sub>	Repetitive Peak Off-state Voltage	K2000yH	180		V
		K2200yH	180		
		K2400yH	190		
		K2500yH	200		
I <sub>TR(RMS)</sub>	On-state RMS Current	50/60Hz, T <sub>j</sub> < 125°C		1	A
V <sub>TM</sub>	Peak On-state Voltage	I <sub>T</sub> = 1A		1.5	V
I <sub>H</sub>	Dynamic Holding Current	R <sub>T</sub> = 100Ω 50/60Hz Sine Wave		150	mA
R <sub>S</sub>	Switching Resistance, $R_s = \frac{(V_{BO} - V_s)}{(I_s - I_{BO})}$	50/60Hz Sine Wave	100		Ω
I <sub>BO</sub>	Breakover Current	50/60Hz Sine Wave		50	μA
I <sub>TRM</sub>	Peak Repetitive Pulse Current (refer to figure 4)	t <sub>p</sub> = 10μs	60Hz	120	A
			5Hz	280	
di/dt	Critical Rate of Rise of On-State Current			150	A/μs
dv/dt	Critical Rate of Rise of Off-State Voltage		1500		V/μs
T <sub>S</sub>	Storage Temperature Range		-40	150	°C
T <sub>J</sub>	Junction Temperature Range		-40	125	°C
R <sub>θJL</sub>	Thermal Resistance, Junction to Lead	DO-15		18	°C/W
		DO-214		30	
R <sub>θJC</sub>	Thermal Resistance, Junction to Case	TO-92		35	°C/W
R <sub>θJA</sub>	Thermal Resistance, Junction to Ambient	DO-15		75	°C/W
		TO-92		95	

Note: xxx - voltage, y = package

**Figure 1: V-I Characteristics**



**Figure 2: On-state Current vs. On-state Voltage (Typical)**



**Figure 3: Power Dissipation vs. On-state Current (Typical)**



**Figure 4: Repetitive Peak On-state Current ( $I_{TRM}$ ) vs. Pulse Width at Various Frequencies**



**Figure 5: Surge Peak On-state Current vs. Number of Cycles**

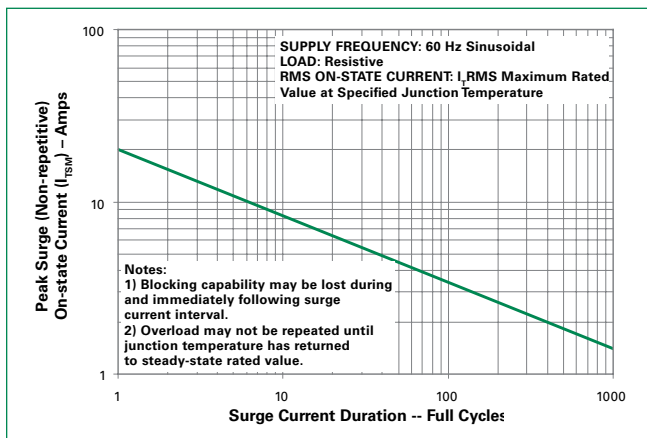

**Figure 6: Normalized  $V_{BO}$  Change vs. Junction Temperature**

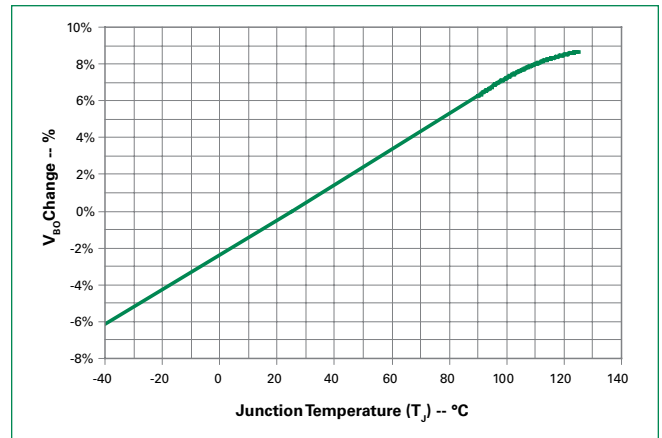

**Figure 7: Normalized DC Holding Current vs. Junction Temperature**

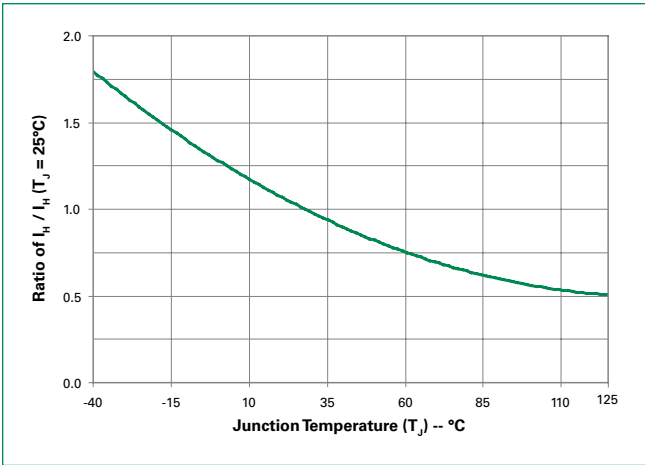

**Figure 8: Maximum Allowable Case Temperature vs. RMS On-State Current**



**Figure 9: Maximum Allowable Ambient Temperature vs. RMS On-State Current**

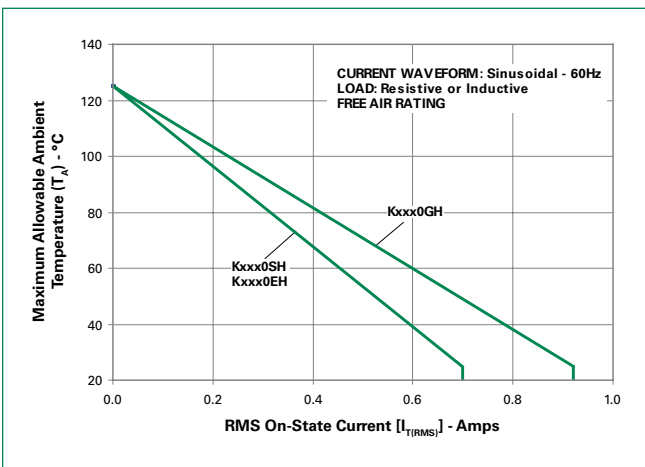

**Figure 10: Normalized Repetitive Peak Breakover Current ( $I_{BO}$ ) vs. Junction Temperature**



**Figure 11: Dynamic Holding Current Test Circuit for SIDACs**

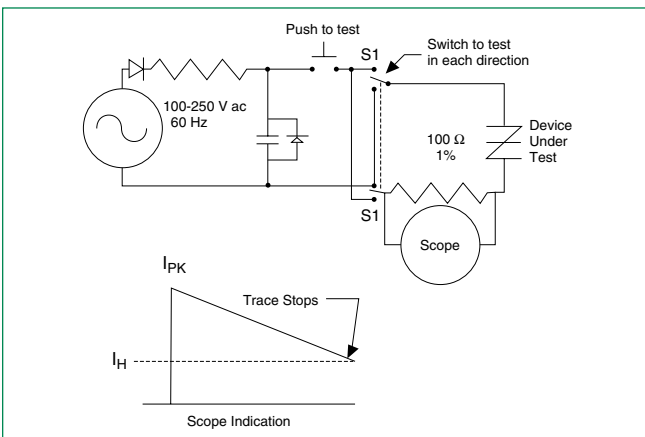

**Figure 12: Basic SIDAC Circuit**

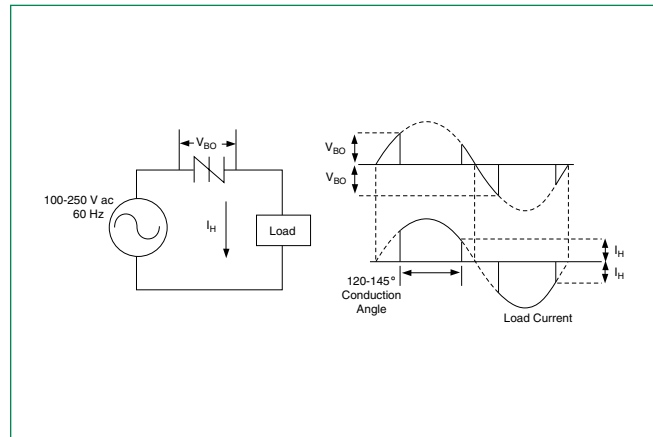

**Figure 13: Relaxation Oscillator Using a SIDAC**



**Figure 14: General Gas Ignitor Circuit**



**Soldering Parameters**

Reflow Condition		Pb – Free assembly
Pre Heat	- Temperature Min ( $T_{s(min)}$ )	150°C
	- Temperature Max ( $T_{s(max)}$ )	200°C
	- Time (min to max) ( $t_s$ )	60 – 180 secs
Average ramp up rate (Liquidus Temp ( $T_L$ ) to peak)		5°C/second max
$T_{s(max)}$ to $T_L$ - Ramp-up Rate		5°C/second max
Reflow	- Temperature ( $T_L$ ) (Liquidus)	217°C
	- Temperature ( $t_L$ )	60 – 150 seconds
Peak Temperature ( $T_p$ )		260 <sup>+0/-5</sup> °C
Time within 5°C of actual peak Temperature ( $t_p$ )		20 – 40 seconds
Ramp-down Rate		5°C/second max
Time 25°C to peak Temperature ( $T_p$ )		8 minutes Max.
Do not exceed		280°C



**Additional Information**



Datasheet



Resources



Samples

**Physical Specifications**

<b>Terminal Material</b>	Copper Alloy
<b>Terminal Finish</b>	100% Matte Tin-plated /Pb Free solder dipped.
<b>Body Material</b>	UL recognized epoxy meeting flammability classification 94V-0.

**Design Considerations**

Careful selection of the correct device for the application's operating parameters and environment will go a long way toward extending the operating life of the Thyristor. Overheating and surge currents are the main killers of SIDACs. Correct mounting, soldering, and forming of the leads also help protect against component damage.

**Reliability/Environmental Tests**

Test	Specifications and Conditions
<b>High Temperature Voltage Blocking</b>	MIL-STD-750: Method 1040, Condition A Rated $V_{DRM}$ (VAC-peak), 125°C, 1008 hours
<b>Temperature Cycling</b>	MIL-STD-750: Method 1051 -40°C to 150°C, 15-minute dwell, 100 cycles
<b>Biased Temperature &amp; Humidity</b>	EIA/JEDEC: JESD22-A101 (VDC), 85°C, 85%RH, 1008 hours
<b>High Temp Storage</b>	MIL-STD-750: Method 1031 150°C, 1008 hours
<b>Low-Temp Storage</b>	-40°C, 1008 hours
<b>Thermal Shock</b>	MIL-STD-750: Method 1056 0°C to 100°C, 5-minute dwell, 10-second transfer, 10 cycles
<b>Autoclave (Pressure Cooker Test)</b>	EIA/JEDEC: JESD22-A102 121°C, 100%RH, 2atm, 168 hours
<b>Resistance to Solder Heat</b>	MIL-STD-750: Method 2031 260°C, 10 seconds
<b>Solderability</b>	ANSI/J-STD-002: Category 3
<b>Repetitive Surge Life Testing</b>	MIL-STD-750: Method 2036, Condition E

**Dimensions — DO-214**



Dimension	Inches		Millimeters	
	Max	Max	Min	Max
A	0.130	0.156	3.30	3.95
B	0.201	0.220	5.10	5.60
C	0.077	0.087	1.95	2.20
D	0.159	0.181	4.05	4.60
E	0.030	0.063	0.75	1.60
F	0.075	0.096	1.90	2.45
G	0.002	0.008	0.05	0.20
H	0.077	0.104	1.95	2.65
K	0.006	0.016	0.15	0.41

**Dimensions — DO-15**



Dimension	Inches		Millimeters	
	Max	Max	Min	Max
øB	0.028	0.034	0.711	0.864
øD	0.120	0.140	3.048	3.556
G	0.235	0.270	5.969	6.858
L	1.000		25.400	

**Dimensions - TO-92 with Type 70 Lead Form**



Dimension	Inches		Millimeters	
	Max	Max	Min	Max
A	0.176	0.196	4.47	4.98
B	0.500		12.70	
D	0.095	0.105	2.41	2.67
E	0.150		3.81	
F	0.046	0.054	1.16	1.37
G	0.135	0.145	3.43	3.68
H	0.088	0.096	2.23	2.44
J	0.176	0.186	4.47	4.73
K	0.088	0.096	2.23	2.44
L	0.013	0.019	0.33	0.48
M	0.013	0.017	0.33	0.43
N		0.060		1.52

- Notes:
1. Type 70 lead form as shown is standard for the E package.
  2. All leads are insulated from case. Case is electrically nonconductive (rated at 16000V ac rms for one minute from leads to case over the operating temperature range.)
  3. Mold flash shall not exceed 0.13 mm per side.

**Product Selector**

Part Number	Switching Voltage Range		Blocking Voltage	Packages		
	V <sub>BO</sub> Minimum	V <sub>BO</sub> Maximum	V <sub>DRM</sub>	DO-15	DO-214	TO-92
K2000yH	190V	215V	180V	K2000GH	K2000SH	K2000EH70
K2200yH	205V	230V	180V	K2200GH	K2200SH	K2200EH70
K2400yH	220V	250V	190V	K2400GH	K2400SH	K2400EH70
K2500yH	240V	280V	200V	K2500GH	K2500SH	K2500EH70

Note: y = package

**Packing Options**

Part Number	Marking	Weight	Packaging Mode	Base Quantity
Kxxx0GH	Kxxx0GH	0.38g	Bulk	1000
Kxxx0GHRP	Kxxx0GH	0.38g	Reel Pack	5000
Kxxx0SHRP	KxxSH	0.1g	Reel Pack	2500
Kxxx0EH70	Kxxx0EH	0.17g	Bulk	2000
Kxxx0EH70AP	Kxxx0EH	0.17g	Ammo Pack	2000
Kxxx0EH70RP2	Kxxx0EH	0.17g	Reel Pack	2000
Kxxx0EH70RP3	Kxxx0EH	0.17g	Reel Pack	2000

Note: xxx or xx = voltage

**DO-214 Embossed Carrier Reel Pack (RP) Specifications**

**Meets all EIA-481-1 Standards**



**DO-15 Reel Pack (RP) Specifications**

Meets all EIA RS-296 Standards



**TO-92 Type 70 Ammo Pack (AP) Radial Leaded Specifications**

Meets all EIA-468-C Standards

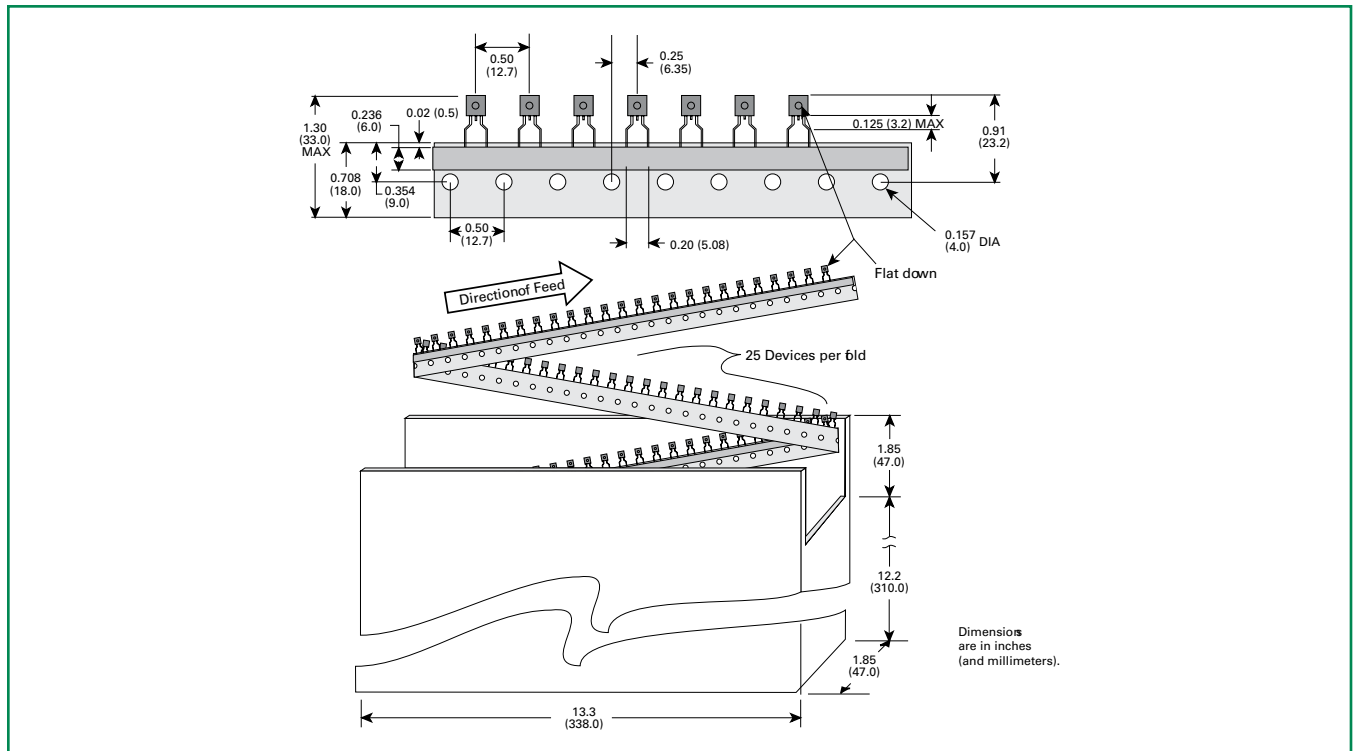



**TO-92 Type 70 Reel Pack (RP3) Optional Specifications**



**TO-92 Type 70 Reel Pack (RP2) Standard Specifications**

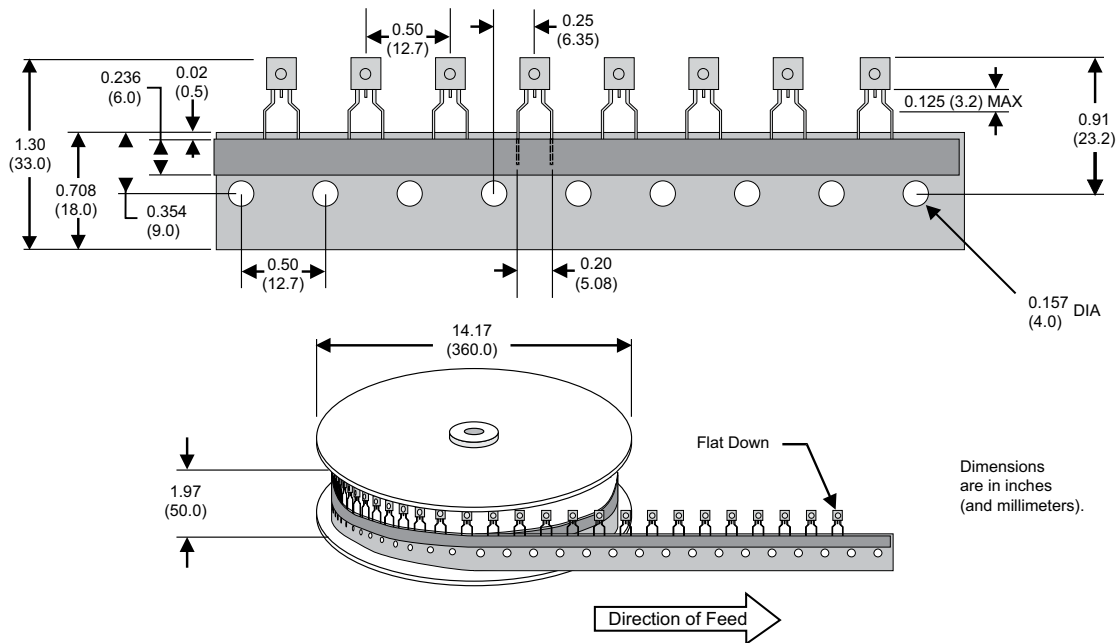

### Part Numbering System



### Part Marking System



Компания «Life Electronics» занимается поставками электронных компонентов импортного и отечественного производства от производителей и со складов крупных дистрибьюторов Европы, Америки и Азии.

С конца 2013 года компания активно расширяет линейку поставок компонентов по направлению коаксиальный кабель, кварцевые генераторы и конденсаторы (керамические, пленочные, электролитические), за счёт заключения дистрибьюторских договоров

Мы предлагаем:

- Конкурентоспособные цены и скидки постоянным клиентам.
- Специальные условия для постоянных клиентов.
- Подбор аналогов.
- Поставку компонентов в любых объемах, удовлетворяющих вашим потребностям.
- Приемлемые сроки поставки, возможна ускоренная поставка.
- Доставку товара в любую точку России и стран СНГ.
- Комплексную поставку.
- Работу по проектам и поставку образцов.
- Формирование склада под заказчика.
- Сертификаты соответствия на поставляемую продукцию (по желанию клиента).
- Тестирование поставляемой продукции.
- Поставку компонентов, требующих военную и космическую приемку.
- Входной контроль качества.
- Наличие сертификата ISO.

В составе нашей компании организован Конструкторский отдел, призванный помогать разработчикам, и инженерам.

Конструкторский отдел помогает осуществить:

- Регистрацию проекта у производителя компонентов.
- Техническую поддержку проекта.
- Защиту от снятия компонента с производства.
- Оценку стоимости проекта по компонентам.
- Изготовление тестовой платы монтаж и пусконаладочные работы.



Тел: +7 (812) 336 43 04 (многоканальный)  
Email: [org@lifeelectronics.ru](mailto:org@lifeelectronics.ru)