



Mn-Zn

# Large Size Ferrite Cores for High Power

## E series

---

EC  
EIC  
EE  
EI

---

**REMINDERS FOR USING THESE PRODUCTS**

Please be sure to read this manual thoroughly before using the products.

The products listed on this catalog are intended for use in general electronic equipment (AV equipment, telecommunications equipment, home appliances, amusement equipment, computer equipment, personal equipment, office equipment, measurement equipment, industrial robots) under a normal operation and use condition.

The products are not designed or warranted to meet the requirements of the applications listed below, whose performance and/or quality require a more stringent level of safety or reliability, or whose failure, malfunction or trouble could cause serious damage to society, person or property.

When using the products for specific purposes, please first make confirmations in areas such as safety, reliability, and quality.

Please understand that we are not in a position to be held responsible for any damage or the like caused by any use exceeding the range or conditions of this specification sheet or by any use in the specific applications.

- |   |  |
|---|--|
| (1) Aerospace/Aviation equipment                            | (8) Public information-processing equipment                                  |
| (2) Transportation equipment (electric trains, ships, etc.) | (9) Military equipment   |
| (3) Medical equipment                                       | (10) Electric heating apparatus, burning equipment                           |
| (4) Power-generation control equipment                      | (11) Disaster prevention/crime prevention equipment                          |
| (5) Atomic energy-related equipment                         | (12) Safety equipment  |
| (6) Seabed equipment  | (13) Other applications that are not considered general-purpose applications |
| (7) Transportation control equipment                        |  |

When using this product in general-purpose standard applications, you are kindly requested to take into consideration securing protection circuit/equipment or providing backup circuits, etc to ensure higher safety.

# Large Size Ferrite Cores for High Power

Product compatible with RoHS directive  
Halogen-free

## Overview of the E Series

### FEATURES

- Large size cores for transformers with large power outputs.
- Can also be used in reactors.

### APPLICATION

- Large size industrial equipment, transformers for consumer equipment
- Reactors

### PART NUMBER CONSTRUCTION

Material	Core shape	Width	Thickness	Inside Diameter
PE22	EC	70	69	16
PC40	EIC	90	90	30
	EE	80	101	19
	EI	120	46	20
			55	31N
			65	
			91	
			76	
			56	
			108	
			64	

### RANGE OF USE AND STORAGE TEMPERATURE

Temperature range	
Operating temperature (°C)	Storage temperature (°C)
-30 to +105	-30 to +85

- RoHS Directive Compliant Product: See the following for more details. <https://product.tdk.com/info/en/environment/rohs/index.html>
- Halogen-free: Indicates that Cl content is less than 900ppm, Br content is less than 900ppm, and that the total Cl and Br content is less than 1500ppm.

 Please be sure to request delivery specifications that provide further details on the features and specifications of the products for proper and safe use. Please note that the contents may change without any prior notice due to reasons such as upgrading.

## Mn-Zn EC Cores

## SHAPES AND DIMENSIONS



PE22	EC	70	x	69	x	16
<b>Material</b>	<b>Core shape</b>	<b>Width</b>		<b>Thickness</b>		<b>Inside Diameter</b>

Part No.	Dimensions (mm)											
	A	B×2	C	$\phi D$	$\phi E$	F×2	M	J	R	K	K×2F(mm <sup>2</sup> )	
PE22 EC70×69×16 PC40 EC70×69×16	70.0±1.7	69.0±1.0	16.4±0.5	16.4±0.5	43.3min.	45.5±1.0	5.2	4.75	1max.	14.1	639	
PE22 EC90×90×30 PC40 EC90×90×30	90.0±1.8	90.0±1.3	30.0±1.0	30.0±1.0	68.5min.	71.0±1.0	5.5	6.0	1max.	20.0	1420	
PE22 EC120×101×30 PC40 EC120×101×30	120.0±2.0	101.0±1.3	30.0±1.0	30.0±1.0	93.3min.	71.0±1.0	5.5	6.03	1.5max.	32.5	2307	

Part No.	Effective parameter							Electrical characteristics <b>AL-value</b>  (nH/N <sup>2</sup> ) 1kHz 0.4A/m 23°C
	Core factor		Effective cross-sectional area $A_e$ (mm <sup>2</sup> )	Effective magnetic path length $\ell_e$ (mm)	Effective core volume $V_e$ (mm <sup>3</sup> )	Weigh(approx.) (g)	AL-value	
	$C_1$ (mm <sup>-1</sup> )	$C_2 \times 10^{-2}$ (mm <sup>-3</sup> )						
PE22 EC70×69×16 PC40 EC70×69×16	0.5138891	0.18322	280	144	40420	250 250	3910±25% 4845±25%	
PE22 EC90×90×30 PC40 EC90×90×30	0.3533380	0.05648	626	221	138270	635 635	5925±25% 7415±25%	
PE22 EC120×101×30 PC40 EC120×101×30	0.3300745	0.04278	772	255	196490	986 986	6395±25% 8025±25%	

# Mn-Zn EC series **Part No.: PE22 EC70X69X16**

## ■ SHAPES AND DIMENSIONS



Effective parameter								Electrical characteristics	
Core factor		Effective magnetic path length	Effective cross-sectional area	Effective core volume	Cross-sectional center pole area	Minimum cross-sectional area	Winding cross-sectional area	Weigh (approx.)	AL-value
$C_1$ (mm <sup>-1</sup> )	$C_2 \times 10^{-2}$ (mm <sup>-3</sup> )	$l_e$ (mm)	$A_e$ (mm <sup>2</sup> )	$V_e$ (mm <sup>3</sup> )	$A_c$ (mm <sup>2</sup> )	$A_{min.}^*$ (mm <sup>2</sup> )	$A_{cw}$ (mm <sup>2</sup> )	(g)	(nH/N <sup>2</sup> ) 1kHz 0.4A/m 23°C
0.5138891	0.18322	144	280	40420	211	211C*	642	250	3910±25%

\* The symbol followed A min. value shows minimum cross-sectional area part.  
 L is outer pole part, B is the back part.  
 ○ Calculated output power (forward converter mode): 1.1kW (100kHz)

### NI limit vs. AL-value



The 20% and 40% graph shows when a 20% and 40% drop from the initial AL-value has been made due to the DC superimposition.

### AL-value vs. Air gap length



 Please be sure to request delivery specifications that provide further details on the features and specifications of the products for proper and safe use. Please note that the contents may change without any prior notice due to reasons such as upgrading.

# Mn-Zn EC series **Part No.: PC40 EC70X69X16**

## ■ SHAPES AND DIMENSIONS



Effective parameter									Electrical characteristics
Core factor		Effective magnetic path length	Effective cross-sectional area	Effective core volume	Cross-sectional center pole area	Minimum cross-sectional area	Winding cross-sectional area	Weigh (approx.)	AL-value
$C_1$ (mm <sup>-1</sup> )	$C_2 \times 10^{-2}$ (mm <sup>-3</sup> )	$l_e$ (mm)	$A_e$ (mm <sup>2</sup> )	$V_e$ (mm <sup>3</sup> )	$A_c$ (mm <sup>2</sup> )	$A_{min.}^*$ (mm <sup>2</sup> )	$A_{cw}$ (mm <sup>2</sup> )	(g)	(nH/N <sup>2</sup> ) 1kHz 0.4A/m 23°C
0.5138891	0.18322	144	280	40420	211	211C*	642	250	4845±25%

\* The symbol followed A min. value shows minimum cross-sectional area part.  
 L is outer pole part, B is the back part.  
 ○ Calculated output power (forward converter mode): 1.2kW (100kHz)

### NI limit vs. AL-value



The 20% and 40% graph shows when a 20% and 40% drop from the initial AL-value has been made due to the DC superimposition.

### AL-value vs. Air gap length



⚠ Please be sure to request delivery specifications that provide further details on the features and specifications of the products for proper and safe use.  
 Please note that the contents may change without any prior notice due to reasons such as upgrading.

# Mn-Zn EC series **Part No.: PE22 EC90X90X30**

## ■ SHAPES AND DIMENSIONS



Effective parameter									Electrical characteristics
Core factor		Effective magnetic path length	Effective cross-sectional area	Effective core volume	Cross-sectional center pole area	Minimum cross-sectional area	Winding cross-sectional area	Weigh (approx.)	AL-value
C <sub>1</sub> (mm <sup>-1</sup> )	C <sub>2</sub> ×10 <sup>-2</sup> (mm <sup>-3</sup> )	ℓ <sub>e</sub> (mm)	A <sub>e</sub> (mm <sup>2</sup> )	V <sub>e</sub> (mm <sup>3</sup> )	A <sub>c</sub> (mm <sup>2</sup> )	A min.* (mm <sup>2</sup> )	A <sub>cw</sub> (mm <sup>2</sup> )	(g)	(nH/N <sup>2</sup> ) 1kHz 0.4A/m 23°C
0.3533380	0.05648	221	626	138270	707	570B*	1420	635	5925±25%

\* The symbol followed A min. value shows minimum cross-sectional area part.  
 C is center pole part, L is outer pole part, B is the back part.  
 ○ Calculated output power (forward converter mode): 3.2kW (100kHz)

### NI limit vs. AL-value



The 20% and 40% graph shows when a 20% and 40% drop from the initial AL-value has been made due to the DC superimposition.

### AL-value vs. Air gap length



⚠ Please be sure to request delivery specifications that provide further details on the features and specifications of the products for proper and safe use.  
 Please note that the contents may change without any prior notice due to reasons such as upgrading.

# Mn-Zn EC series **Part No.: PC40 EC90X90X30**

## ■ SHAPES AND DIMENSIONS



Effective parameter									Electrical characteristics
Core factor		Effective magnetic path length	Effective cross-sectional area	Effective core volume	Cross-sectional center pole area	Minimum cross-sectional area	Winding cross-sectional area	Weigh (approx.)	AL-value
C <sub>1</sub> (mm <sup>-1</sup> )	C <sub>2</sub> ×10 <sup>-2</sup> (mm <sup>-3</sup> )	ℓ <sub>e</sub> (mm)	A <sub>e</sub> (mm <sup>2</sup> )	V <sub>e</sub> (mm <sup>3</sup> )	A <sub>c</sub> (mm <sup>2</sup> )	A min.* (mm <sup>2</sup> )	A <sub>cw</sub> (mm <sup>2</sup> )	(g)	(nH/N <sup>2</sup> ) 1kHz 0.4A/m 23°C
0.3533380	0.05648	221	626	138270	707	570B*	1420	635	7415±25%

\* The symbol followed A min. value shows minimum cross-sectional area part.  
 C is center pole part, L is outer pole part, B is the back part.  
 ○ Calculated output power (forward converter mode): 3.4kW (100kHz)

### NI limit vs. AL-value



The 20% and 40% graph shows when a 20% and 40% drop from the initial AL-value has been made due to the DC superimposition.

### AL-value vs. Air gap length



⚠ Please be sure to request delivery specifications that provide further details on the features and specifications of the products for proper and safe use.  
 Please note that the contents may change without any prior notice due to reasons such as upgrading.



# Mn-Zn EC series **Part No.: PE22 EC120X101X30**

## SHAPES AND DIMENSIONS



Effective parameter									Electrical characteristics
Core factor		Effective magnetic path length	Effective cross-sectional area	Effective core volume	Cross-sectional center pole area	Minimum cross-sectional area	Winding cross-sectional area	Weight (approx.)	AL-value
$C_1$ (mm <sup>-1</sup> )	$C_2 \times 10^{-2}$ (mm <sup>-3</sup> )	$l_e$ (mm)	$A_e$ (mm <sup>2</sup> )	$V_e$ (mm <sup>3</sup> )	$A_c$ (mm <sup>2</sup> )	$A_{min.}^*$ (mm <sup>2</sup> )	$A_{cw}$ (mm <sup>2</sup> )	(g)	(nH/N <sup>2</sup> ) 1kHz 0.4A/m 23°C
0.3300745	0.04278	255	773	196490	707	707C*	2307	986	6395±25%

\* The symbol followed A min. value shows minimum cross-sectional area part.  
 C is center pole part, L is outer pole part, B is the back part.  
 ○ Calculated output power (forward converter mode): 4.3kW (100kHz)

### NI limit vs. AL-value



The 20% and 40% graph shows when a 20% and 40% drop from the initial AL-value has been made due to the DC superimposition.

### AL-value vs. Air gap length



 Please be sure to request delivery specifications that provide further details on the features and specifications of the products for proper and safe use. Please note that the contents may change without any prior notice due to reasons such as upgrading.

Mn-Zn EC series **Part No.: PC40 EC120X101X30**

## ■ SHAPES AND DIMENSIONS



Effective parameter									Electrical characteristics
Core factor		Effective magnetic path length	Effective cross-sectional area	Effective core volume	Cross-sectional center pole area	Minimum cross-sectional area	Winding cross-sectional area	Weight (approx.)	AL-value
$C_1$ (mm <sup>-1</sup> )	$C_2 \times 10^{-2}$ (mm <sup>-3</sup> )	$l_e$ (mm)	$A_e$ (mm <sup>2</sup> )	$V_e$ (mm <sup>3</sup> )	$A_c$ (mm <sup>2</sup> )	$A_{min.}^*$ (mm <sup>2</sup> )	$A_{cw}$ (mm <sup>2</sup> )	(g)	(nH/N <sup>2</sup> ) 1kHz 0.4A/m 23°C
0.3300745	0.04278	255	773	196490	707	707C*	2307	986	8025±25%

\* The symbol followed A min. value shows minimum cross-sectional area part.

C is center pole part, L is outer pole part, B is the back part.

○ Calculated output power (forward converter mode): 4.5kW (100kHz)

## NI limit vs. AL-value



The 20% and 40% graph shows when a 20% and 40% drop from the initial AL-value has been made due to the DC superimposition.

## AL-value vs. Air gap length



## Mn-Zn EIC Cores



## SHAPES AND DIMENSIONS



PE22	EC	70	×	69	×	16
Material	Core shape	Width		Thickness		Inside Diameter

Part No.	Dimensions (mm)										
	A	B+I	C	$\phi D$	$\phi E$	F	I	M	J	K	
PE22 EIC70×46×16 PC40 EIC70×46×16	70.0±1.7	46.25±1.0	16.4±0.5	16.4±0.5	43.3min.	22.75±0.5	11.75±0.5	5.2	4.75	14.1	
PE22 EIC90×55×30 PC40 EIC90×55×30	90.0±1.8	55.0±1.0	30.0±1.0	30.0±1.0	68.5min.	35.5±0.5	10.0±0.35	5.5	6.0	20.0	
PE22 EIC120×65×30 PC40 EIC120×65×30	120.0±2.0	65.5±1.3	30.0±1.0	30.0±1.0	93.3min.	35.5±0.5	15.0±0.65	5.5	6.0	32.5	

Part No.	Effective parameter						Electrical characteristics AL-value  (nH/N <sup>2</sup> ) 1kHz 0.4A/m 23°C
	Core factor		Effective cross-sectional area $A_e$ (mm <sup>2</sup> )	Effective magnetic path length $\ell_e$ (mm)	Effective core volume $V_e$ (mm <sup>3</sup> )	Weigh (approx.) (g)	
	$C_1$ (mm <sup>-1</sup> )	$C_2 \times 10^{-2}$ (mm <sup>-3</sup> )					
PE22 EIC70×46×16 PC40 EIC70×46×16	0.3479	0.1173	297	103	30601	188 188	5550±25% 6810±25%
PE22 EIC90×55×30 PC40 EIC90×55×30	0.2422	0.0388	624	151	94432	469 469	8350±25% 10365±25%
PE22 EIC120×65×30 PC40 EIC120×65×30	0.2319	0.0292	794	184	146310	747 747	8890±25% 11085±25%

⚠ Please be sure to request delivery specifications that provide further details on the features and specifications of the products for proper and safe use.  
Please note that the contents may change without any prior notice due to reasons such as upgrading.

Mn-Zn EIC series **Part No.: PE22 EIC90X55X30**

## ■ SHAPES AND DIMENSIONS

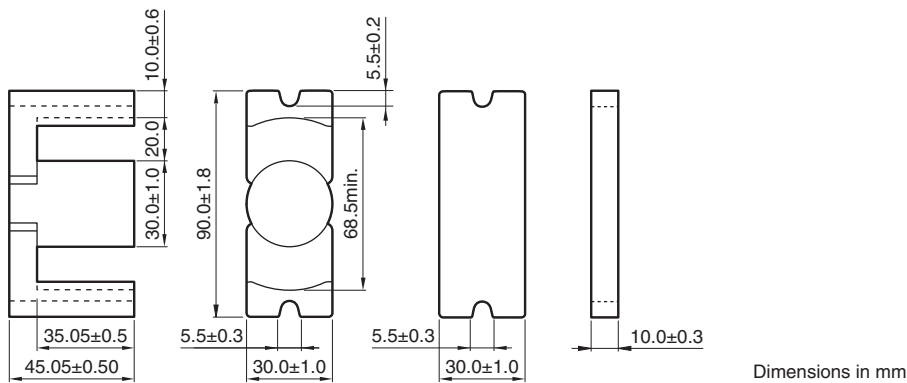

Effective parameter									Electrical characteristics
Core factor		Effective magnetic path length	Effective cross-sectional area	Effective core volume	Cross-sectional center pole area	Minimum cross-sectional area	Winding cross-sectional area	Weight (approx.)	AL-value
$C_1$ (mm <sup>-1</sup> )	$C_2 \times 10^{-2}$ (mm <sup>-3</sup> )	$l_e$ (mm)	$A_e$ (mm <sup>2</sup> )	$V_e$ (mm <sup>3</sup> )	$A_c$ (mm <sup>2</sup> )	$A_{min.}^*$ (mm <sup>2</sup> )	$A_{cw}$ (mm <sup>2</sup> )	(g)	(nH/N <sup>2</sup> ) 1kHz 0.4A/m 23°C
0.2422	0.0388	151	624	94432	707	586B*	710	469	8350±25%

\* The symbol followed A min. value shows minimum cross-sectional area part.

C is center pole part, L is outer pole part, B is the back part.

○ Calculated output power (forward converter mode): 1.8kW (100kHz)

Mn-Zn EIC series **Part No.: PC40 EIC90X55X30**

## ■ SHAPES AND DIMENSIONS



Effective parameter									Electrical characteristics
Core factor		Effective magnetic path length	Effective cross-sectional area	Effective core volume	Cross-sectional center pole area	Minimum cross-sectional area	Winding cross-sectional area	Weight (approx.)	AL-value
$C_1$ (mm <sup>-1</sup> )	$C_2 \times 10^{-2}$ (mm <sup>-3</sup> )	$l_e$ (mm)	$A_e$ (mm <sup>2</sup> )	$V_e$ (mm <sup>3</sup> )	$A_c$ (mm <sup>2</sup> )	$A_{min.}^*$ (mm <sup>2</sup> )	$A_{cw}$ (mm <sup>2</sup> )	(g)	(nH/N <sup>2</sup> ) 1kHz 0.4A/m 23°C
0.2422	0.0388	151	624	94432	707	586B*	710	469	10365±25%

\* The symbol followed A min. value shows minimum cross-sectional area part.

C is center pole part, L is outer pole part, B is the back part.

○ Calculated output power (forward converter mode): 1.9kW (100kHz)

Mn-Zn EIC series **Part No.: PE22 EIC120X65X30**

## ■ SHAPES AND DIMENSIONS



Effective parameter									Electrical characteristics
Core factor		Effective magnetic path length	Effective cross-sectional area	Effective core volume	Cross-sectional center pole area	Minimum cross-sectional area	Winding cross-sectional area	Weight (approx.)	AL-value
$C_1$ (mm <sup>-1</sup> )	$C_2 \times 10^{-2}$ (mm <sup>-3</sup> )	$l_e$ (mm)	$A_e$ (mm <sup>2</sup> )	$V_e$ (mm <sup>3</sup> )	$A_c$ (mm <sup>2</sup> )	$A_{min.}^*$ (mm <sup>2</sup> )	$A_{cw}$ (mm <sup>2</sup> )	(g)	(nH/N <sup>2</sup> ) 1kHz 0.4A/m 23°C
0.2319	0.0292	184	794	146310	707	707C*	1154	747	8890±25%

\* The symbol followed A min. value shows minimum cross-sectional area part.

C is center pole part, L is outer pole part, B is the back part.

• Available customize core like this. Please specify when ordering.

○ Calculated output power (forward converter mode): 2.8kW (100kHz)

Mn-Zn EIC series **Part No.: PC40 EIC120X65X30**

## ■ SHAPES AND DIMENSIONS



Effective parameter									Electrical characteristics
Core factor		Effective magnetic path length	Effective cross-sectional area	Effective core volume	Cross-sectional center pole area	Minimum cross-sectional area	Winding cross-sectional area	Weight (approx.)	AL-value
$C_1$ ( $\text{mm}^{-1}$ )	$C_2 \times 10^{-2}$ ( $\text{mm}^{-3}$ )	$l_e$ (mm)	$A_e$ ( $\text{mm}^2$ )	$V_e$ ( $\text{mm}^3$ )	$A_c$ ( $\text{mm}^2$ )	$A_{\text{min.}}$ ( $\text{mm}^2$ )	$A_{\text{cw}}$ ( $\text{mm}^2$ )	(g)	( $\text{nH/N}^2$ ) 1kHz 0.4A/m 23°C
0.2319	0.0292	184	794	146310	707	707C*	1154	747	11085±25%

\* The symbol followed A min. value shows minimum cross-sectional area part.

C is center pole part, L is outer pole part, B is the back part.

• Available customize core like this. Please specify when ordering.

○ Calculated output power (forward converter mode): 2.9kW (100kHz)

# Mn-Zn EE Cores



## SHAPES AND DIMENSIONS



PE22	EE	70	×	91	×	19
<b>Material</b>	<b>Core shape</b>	<b>Width</b>		<b>Thickness</b>		<b>Inside Diameter</b>

Part No.	Dimensions (mm)										
	A	2B	C	D	E	2F	H	R	K	K×2F(mm <sup>2</sup> )	
PE22 EE70×91×19 PC40 EE70×91×19	70.0±1.5	91.0±1.0	19.5±0.5	19.5±0.5	48.5min.	71.0±1.0	10.0±0.5	0	15.3	1086	
PE22 EE80×76×20 PC40 EE80×76×20	80.0±1.5	76.0±1.0	20.0±0.5	20.0±0.5	58.5min.	55.0±0.8	10.0±0.5	0.5max.	20.0	1100	
PE22 EE90×56×16 PC40 EE90×56×16	90.0±2.0	56.4±1.0	16.5±0.5	25.0±1.0	63.0min.	30.4±1.0	12.5±0.5	0.5max.	20.0	608	
PE22 EE70×108×31N PC40 EE70×108×31N	70.0±1.5	108.0±1.0	31.6±0.5	22.2±0.5	46.3min.	85.6±1.0	11.1±0.5	2.0max.	12.8	1096	

Part No.	Effective parameter							Electrical characteristics AL-value (nH/N <sup>2</sup> ) 1kHz 0.4A/m 23°C
	Core factor		Effective cross-sectional area A <sub>e</sub> (mm <sup>2</sup> )	Effective magnetic path length l <sub>e</sub> (mm)	Effective core volume V <sub>e</sub> (mm <sup>3</sup> )	Weigh (approx.) (g)	AL-value	
	C <sub>1</sub> (mm <sup>-1</sup> )	C <sub>2</sub> ×10 <sup>-2</sup> (mm <sup>-3</sup> )						
PE22 EE70×91×19 PC40 EE70×91×19	0.52779	0.13669	386	204	78690	394 394	3930±25% 4910±25%	
PE22 EE80×76×20 PC40 EE80×76×20	0.44878	0.11058	406	182	73910	372 372	4590±25% 5720±25%	
PE22 EE90×56×16 PC40 EE90×56×16	0.33583	0.08009	419	141	59050	306 306	5960±25% 7380±25%	
PE22 EE70×108×31N PC40 EE70×108×31N	0.32992	0.04695	703	232	162900	815 815	6360±25% 7970±25%	



Mn-Zn EE series **Part No.: PE22 EE70X91X19**

## ■ SHAPES AND DIMENSIONS



Effective parameter									Electrical characteristics
Core factor		Effective magnetic path length	Effective cross-sectional area	Effective core volume	Cross-sectional center pole area	Minimum cross-sectional area	Winding cross-sectional area	Weigh (approx.)	AL-value
$C_1$ (mm <sup>-1</sup> )	$C_2 \times 10^{-2}$ (mm <sup>-3</sup> )	$\ell_e$ (mm)	$A_e$ (mm <sup>2</sup> )	$V_e$ (mm <sup>3</sup> )	$A_c$ (mm <sup>2</sup> )	$A_{min}^*$ (mm <sup>2</sup> )	$A_{cw}$ (mm <sup>2</sup> )	(g)	(nH/N <sup>2</sup> ) 1kHz 0.4A/m 23°C
0.5278	0.1367	204	386	78690	380	380C*	1086	394	3930±25%

\* The symbol followed A min. value shows minimum cross-sectional area part.

C is center pole part, L is outer pole part, B is the back part.

○ Calculated output power (forward converter mode): 1.4kW (100kHz)

## NI limit vs. AL-value



The 20% and 40% graph shows when a 20% and 40% drop from the initial AL-value has been made due to the DC superimposition.

## AL-value vs. Air gap length



# Mn-Zn EE series **Part No.: PC40 EE70X91X19**

## ■ SHAPES AND DIMENSIONS

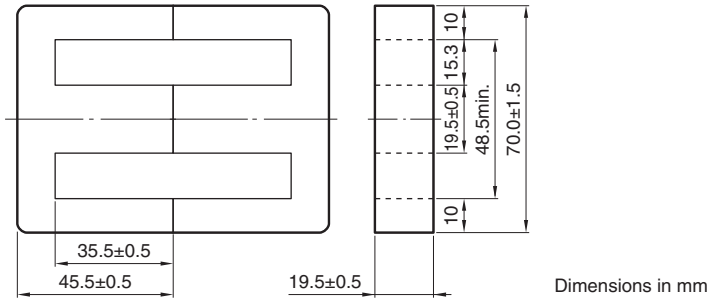

Effective parameter									Electrical characteristics
Core factor		Effective magnetic path length	Effective cross-sectional area	Effective core volume	Cross-sectional center pole area	Minimum cross-sectional area	Winding cross-sectional area	Weigh (approx.)	AL-value
C <sub>1</sub> (mm <sup>-1</sup> )	C <sub>2</sub> ×10 <sup>-2</sup> (mm <sup>-3</sup> )	ℓ <sub>e</sub> (mm)	A <sub>e</sub> (mm <sup>2</sup> )	V <sub>e</sub> (mm <sup>3</sup> )	A <sub>c</sub> (mm <sup>2</sup> )	A min.* (mm <sup>2</sup> )	A <sub>cw</sub> (mm <sup>2</sup> )	(g)	(nH/N <sup>2</sup> ) 1kHz 0.4A/m 23°C
0.5278	0.1367	204	386	78690	380	380C*	1086	394	4910±25%

\* The symbol followed A min. value shows minimum cross-sectional area part.

C is center pole part, L is outer pole part, B is the back part.

○ Calculated output power (forward converter mode): 1.6kW (100kHz)

### NI limit vs. AL-value

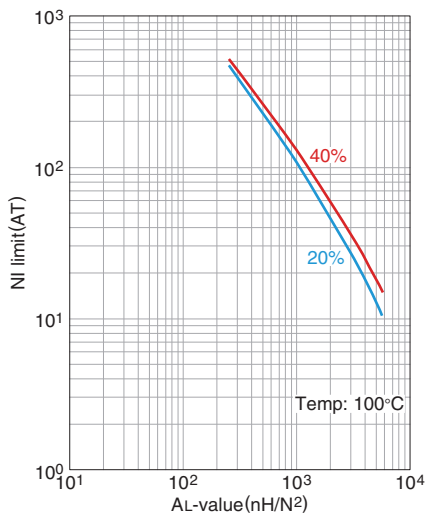

The 20% and 40% graph shows when a 20% and 40% drop from the initial AL-value has been made due to the DC superimposition.

### AL-value vs. Air gap length

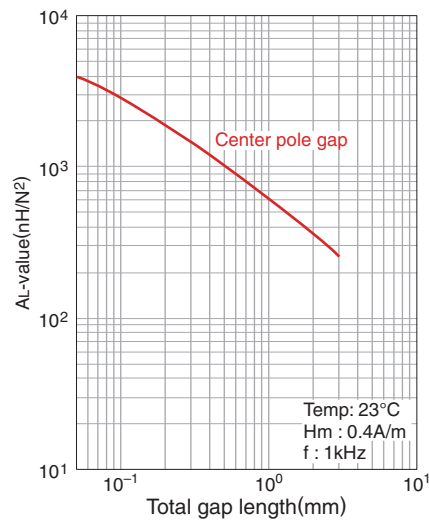

 Please be sure to request delivery specifications that provide further details on the features and specifications of the products for proper and safe use. Please note that the contents may change without any prior notice due to reasons such as upgrading.

Mn-Zn EE series **Part No.: PE22 EE80X76X20**

## ■ SHAPES AND DIMENSIONS



Effective parameter									Electrical characteristics
Core factor		Effective magnetic path length	Effective cross-sectional area	Effective core volume	Cross-sectional center pole area	Minimum cross-sectional area	Winding cross-sectional area	Weigh (approx.)	AL-value
C <sub>1</sub> (mm <sup>-1</sup> )	C <sub>2</sub> ×10 <sup>-2</sup> (mm <sup>-3</sup> )	ℓ <sub>e</sub> (mm)	A <sub>e</sub> (mm <sup>2</sup> )	V <sub>e</sub> (mm <sup>3</sup> )	A <sub>c</sub> (mm <sup>2</sup> )	A min.* (mm <sup>2</sup> )	A <sub>cw</sub> (mm <sup>2</sup> )	(g)	(nH/N <sup>2</sup> ) 1kHz 0.4A/m 23°C
0.44878	0.1106	182	406	73910	400	400LC*	1100	372	4590±25%

\* The symbol followed A min. value shows minimum cross-sectional area part.

C is center pole part, L is outer pole part, B is the back part.

○ Calculated output power (forward converter mode): 1.4kW (100kHz)

## NI limit vs. AL-value

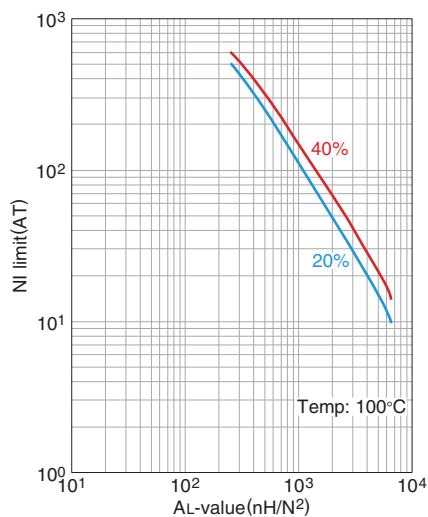

The 20% and 40% graph shows when a 20% and 40% drop from the initial AL-value has been made due to the DC superimposition.

## AL-value vs. Air gap length

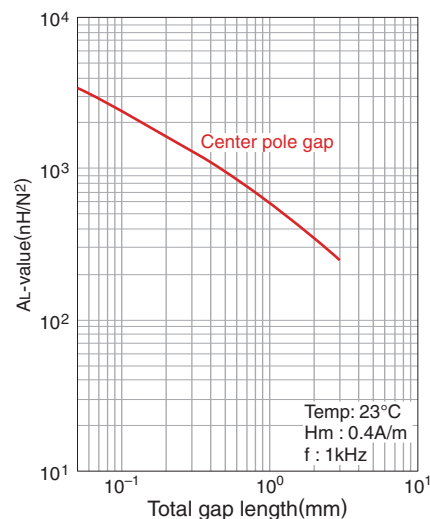

# Mn-Zn EE series Part No.: PC40 EE80X76X20

## SHAPES AND DIMENSIONS



Effective parameter									Electrical characteristics
Core factor		Effective magnetic path length	Effective cross-sectional area	Effective core volume	Cross-sectional center pole area	Minimum cross-sectional area	Winding cross-sectional area	Weigh (approx.)	AL-value
C <sub>1</sub> (mm <sup>-1</sup> )	C <sub>2</sub> ×10 <sup>-2</sup> (mm <sup>-3</sup> )	ℓ <sub>e</sub> (mm)	A <sub>e</sub> (mm <sup>2</sup> )	V <sub>e</sub> (mm <sup>3</sup> )	A <sub>c</sub> (mm <sup>2</sup> )	A min.* (mm <sup>2</sup> )	A <sub>cw</sub> (mm <sup>2</sup> )	(g)	(nH/N <sup>2</sup> ) 1kHz 0.4A/m 23°C
0.44878	0.1106	182	406	73910	400	400LC*	1100	372	5720±25%

\* The symbol followed A min. value shows minimum cross-sectional area part.

C is center pole part, L is outer pole part, B is the back part.

○ Calculated output power (forward converter mode): 1.5kW (100kHz)

### NI limit vs. AL-value



The 20% and 40% graph shows when a 20% and 40% drop from the initial AL-value has been made due to the DC superimposition.

### AL-value vs. Air gap length



⚠ Please be sure to request delivery specifications that provide further details on the features and specifications of the products for proper and safe use. Please note that the contents may change without any prior notice due to reasons such as upgrading.

# Mn-Zn EE series Part No.: PE22 EE90X56X16

## SHAPES AND DIMENSIONS



Effective parameter									Electrical characteristics
Core factor		Effective magnetic path length	Effective cross-sectional area	Effective core volume	Cross-sectional center pole area	Minimum cross-sectional area	Winding cross-sectional area	Weigh (approx.)	AL-value
C <sub>1</sub> (mm <sup>-1</sup> )	C <sub>2</sub> ×10 <sup>-2</sup> (mm <sup>-3</sup> )	ℓ <sub>e</sub> (mm)	A <sub>e</sub> (mm <sup>2</sup> )	V <sub>e</sub> (mm <sup>3</sup> )	A <sub>c</sub> (mm <sup>2</sup> )	A min.* (mm <sup>2</sup> )	A <sub>cw</sub> (mm <sup>2</sup> )	(g)	(nH/N <sup>2</sup> ) 1kHz 0.4A/m 23°C
0.33583	0.0801	144	419	59050	413	413LC*	608	306	5960±25%

\* The symbol followed A min. value shows minimum cross-sectional area part.

C is center pole part, L is outer pole part, B is the back part.

○ Calculated output power (forward converter mode): 1.2kW (100kHz)

### NI limit vs. AL-value



The 20% and 40% graph shows when a 20% and 40% drop from the initial AL-value has been made due to the DC superimposition.

### AL-value vs. Air gap length

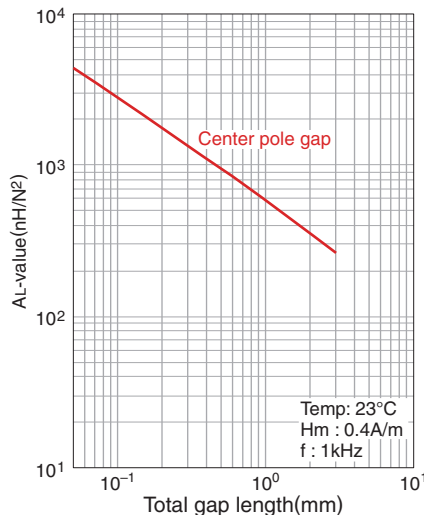

⚠ Please be sure to request delivery specifications that provide further details on the features and specifications of the products for proper and safe use. Please note that the contents may change without any prior notice due to reasons such as upgrading.

# Mn-Zn EE series Part No.: PC40 EE90X56X16

## ■ SHAPES AND DIMENSIONS



Effective parameter									Electrical characteristics
Core factor		Effective magnetic path length	Effective cross-sectional area	Effective core volume	Cross-sectional center pole area	Minimum cross-sectional area	Winding cross-sectional area	Weigh (approx.)	AL-value
$C_1$ (mm <sup>-1</sup> )	$C_2 \times 10^{-2}$ (mm <sup>-3</sup> )	$\ell_e$ (mm)	$A_e$ (mm <sup>2</sup> )	$V_e$ (mm <sup>3</sup> )	$A_c$ (mm <sup>2</sup> )	$A_{min.}^*$ (mm <sup>2</sup> )	$A_{cw}$ (mm <sup>2</sup> )	(g)	(nH/N <sup>2</sup> ) 1kHz 0.4A/m 23°C
0.33583	0.0801	141	419	59050	413	413LC*	608	306	7380±25%

\* The symbol followed A min. value shows minimum cross-sectional area part.  
 C is center pole part, L is outer pole part, B is the back part.  
 ○ Calculated output power (forward converter mode): 1.3kW (100kHz)

### NI limit vs. AL-value

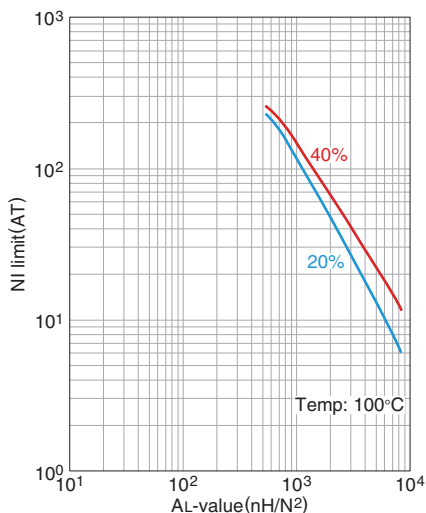

The 20% and 40% graph shows when a 20% and 40% drop from the initial AL-value has been made due to the DC superimposition.

### AL-value vs. Air gap length

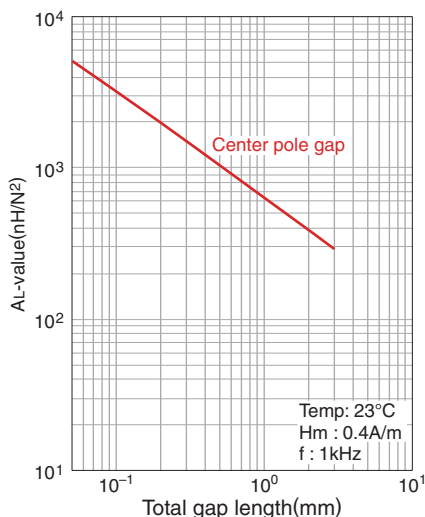

⚠ Please be sure to request delivery specifications that provide further details on the features and specifications of the products for proper and safe use.  
 Please note that the contents may change without any prior notice due to reasons such as upgrading.

# Mn-Zn EI Cores

## SHAPES AND DIMENSIONS



PE22	EI	70	×	55	×	19
Material	Core shape	Width		Thickness		Inside Diameter

Part No.	Dimensions (mm)										
	A	B+I	C	D	E	F	H	I	R	K	K×2F(mm <sup>2</sup> )
PE22 EI70×55×19 PC40 EI70×55×19	70.0±1.5	55.5±1.0	19.5±0.5	19.5±0.5	48.5min.	35.0±0.5	10.0±0.5	10.5±0.5	0.5max.	15.3	536
PE22 EI70×64×31N PC40 EI70×64×31N	70.0±1.5	64.4±1.0	31.6±0.5	22.2±0.5	46.3min.	42.8±0.5	11.1±0.5	10.4±0.5	2.0max.	12.8	548

Part No.	Effective parameter						Electrical characteristics AL-value (nH/N <sup>2</sup> ) 1kHz 0.4A/m 23°C
	Core factor		Effective cross-sectional area A <sub>e</sub> (mm <sup>2</sup> )	Effective magnetic path length l <sub>e</sub> (mm)	Effective core volume V <sub>e</sub> (mm <sup>3</sup> )	Weigh (approx.) (g)	
	C <sub>1</sub> (mm <sup>-1</sup> )	C <sub>2</sub> ×10 <sup>-2</sup> (mm <sup>-3</sup> )					
PE22 EI70×55×19 PC40 EI70×55×19	0.33894	0.08693	390	132	51520	266 266	5880±25% 7270±25%
PE22 EI70×64×31N PC40 EI70×64×31N	0.20929	0.03010	695	146	101200	519 519	9585±25% 11885±25%

Mn-Zn EI series **Part No.: PE22 EI70X55X19**

## ■ SHAPES AND DIMENSIONS



Effective parameter									Electrical characteristics
Core factor		Effective magnetic path length	Effective cross-sectional area	Effective core volume	Cross-sectional center pole area	Minimum cross-sectional area	Winding cross-sectional area	Weigh (approx.)	AL-value
$C_1$ (mm <sup>-1</sup> )	$C_2 \times 10^{-2}$ (mm <sup>-3</sup> )	$\ell_e$ (mm)	$A_e$ (mm <sup>2</sup> )	$V_e$ (mm <sup>3</sup> )	$A_c$ (mm <sup>2</sup> )	$A_{min.}^*$ (mm <sup>2</sup> )	$A_{cw}$ (mm <sup>2</sup> )	(g)	(nH/N <sup>2</sup> ) 1kHz 0.4A/m 23°C
0.33894	0.08693	132	390	51520	380	380C*	543	266	5880±25%

\* The symbol followed A min. value shows minimum cross-sectional area part.

C is center pole part, L is outer pole part, B is the back part.

○ Calculated output power (forward converter mode): 1.4kW (100kHz)

## NI limit vs. AL-value



The 20% and 40% graph shows when a 20% and 40% drop from the initial AL-value has been made due to the DC superimposition.

## AL-value vs. Air gap length

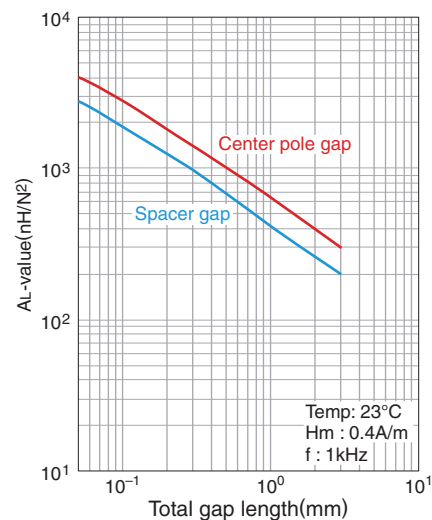



# Mn-Zn EI series Part No.: PC40 EI70X55X19

## SHAPES AND DIMENSIONS

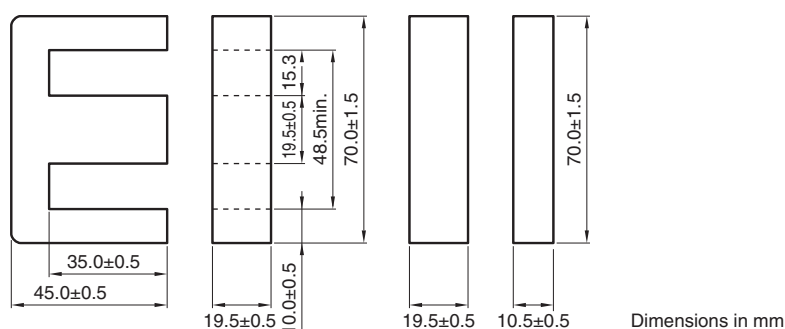

Effective parameter									Electrical characteristics
Core factor		Effective magnetic path length	Effective cross-sectional area	Effective core volume	Cross-sectional center pole area	Minimum cross-sectional area	Winding cross-sectional area	Weigh (approx.)	AL-value
C <sub>1</sub> (mm <sup>-1</sup> )	C <sub>2</sub> ×10 <sup>-2</sup> (mm <sup>-3</sup> )	ℓ <sub>e</sub> (mm)	A <sub>e</sub> (mm <sup>2</sup> )	V <sub>e</sub> (mm <sup>3</sup> )	A <sub>c</sub> (mm <sup>2</sup> )	A min.* (mm <sup>2</sup> )	A <sub>cw</sub> (mm <sup>2</sup> )	(g)	(nH/N <sup>2</sup> ) 1kHz 0.4A/m 23°C
0.33894	0.08693	132	390	51520	380	380C*	543	266	7270±25%

\* The symbol followed A min. value shows minimum cross-sectional area part.

C is center pole part, L is outer pole part, B is the back part.

○ Calculated output power (forward converter mode): 1.6kW (100kHz)

### NI limit vs. AL-value



The 20% and 40% graph shows when a 20% and 40% drop from the initial AL-value has been made due to the DC superimposition.

### AL-value vs. Air gap length



⚠ Please be sure to request delivery specifications that provide further details on the features and specifications of the products for proper and safe use. Please note that the contents may change without any prior notice due to reasons such as upgrading.

Компания «Life Electronics» занимается поставками электронных компонентов импортного и отечественного производства от производителей и со складов крупных дистрибьюторов Европы, Америки и Азии.

С конца 2013 года компания активно расширяет линейку поставок компонентов по направлению коаксиальный кабель, кварцевые генераторы и конденсаторы (керамические, пленочные, электролитические), за счёт заключения дистрибьюторских договоров

Мы предлагаем:

- Конкурентоспособные цены и скидки постоянным клиентам.
- Специальные условия для постоянных клиентов.
- Подбор аналогов.
- Поставку компонентов в любых объемах, удовлетворяющих вашим потребностям.
- Приемлемые сроки поставки, возможна ускоренная поставка.
- Доставку товара в любую точку России и стран СНГ.
- Комплексную поставку.
- Работу по проектам и поставку образцов.
- Формирование склада под заказчика.
- Сертификаты соответствия на поставляемую продукцию (по желанию клиента).
- Тестирование поставляемой продукции.
- Поставку компонентов, требующих военную и космическую приемку.
- Входной контроль качества.
- Наличие сертификата ISO.

В составе нашей компании организован Конструкторский отдел, призванный помогать разработчикам, и инженерам.

Конструкторский отдел помогает осуществить:

- Регистрацию проекта у производителя компонентов.
- Техническую поддержку проекта.
- Защиту от снятия компонента с производства.
- Оценку стоимости проекта по компонентам.
- Изготовление тестовой платы монтаж и пусконаладочные работы.



Тел: +7 (812) 336 43 04 (многоканальный)

Email: [org@lifeelectronics.ru](mailto:org@lifeelectronics.ru)