

## Important notice

Dear Customer,

On 7 February 2017 the former NXP Standard Product business became a new company with the tradename **Nexperia**. Nexperia is an industry leading supplier of Discrete, Logic and PowerMOS semiconductors with its focus on the automotive, industrial, computing, consumer and wearable application markets

In data sheets and application notes which still contain NXP or Philips Semiconductors references, use the references to Nexperia, as shown below.

Instead of <http://www.nxp.com>, <http://www.philips.com/> or <http://www.semiconductors.philips.com/>, use <http://www.nexperia.com>

Instead of [sales.addresses@www.nxp.com](mailto:sales.addresses@www.nxp.com) or [sales.addresses@www.semiconductors.philips.com](mailto:sales.addresses@www.semiconductors.philips.com), use [salesaddresses@nexperia.com](mailto:salesaddresses@nexperia.com) (email)

Replace the copyright notice at the bottom of each page or elsewhere in the document, depending on the version, as shown below:

- © NXP N.V. (year). All rights reserved or © Koninklijke Philips Electronics N.V. (year). All rights reserved

Should be replaced with:

- © **Nexperia B.V. (year). All rights reserved.**

If you have any questions related to the data sheet, please contact our nearest sales office via e-mail or telephone (details via [salesaddresses@nexperia.com](mailto:salesaddresses@nexperia.com)). Thank you for your cooperation and understanding,

Kind regards,

Team Nexperia

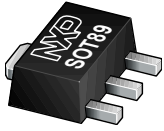

# PBHV8115X

150 V, 1 A NPN high-voltage low  $V_{CEsat}$  (BISS) transistor

9 December 2013

Product data sheet

## 1. General description

NPN high-voltage low  $V_{CEsat}$  Breakthrough In Small Signal (BISS) transistor in a SOT89 (SC-62) medium power and flat lead Surface-Mounted Device (SMD) plastic package.

PNP complement: PBHV9115X.

## 2. Features and benefits

- High voltage
- Low collector-emitter saturation voltage  $V_{CEsat}$
- High collector current capability  $I_C$  and  $I_{CM}$
- High collector current gain ( $h_{FE}$ ) at high  $I_C$
- AEC-Q101 qualified
- Medium power SMD plastic package

## 3. Applications

- LED driver for LED chain module
- LCD backlighting
- High Intensity Discharge (HID) front lighting
- Automotive motor management
- Hook switch for wired telecom
- Switch Mode Power Supply (SMPS)

## 4. Quick reference data

Table 1. Quick reference data

| Symbol    | Parameter                 | Conditions   | Min | Typ | Max | Unit |
|-----------|---------------------------|--|-----|-----|-----|------|
| $V_{CEO}$ | collector-emitter voltage | open base  | -   | -   | 150 | V    |
| $I_C$     | collector current         |  | -   | -   | 1   | A    |
| $h_{FE}$  | DC current gain           | $V_{CE} = 10\text{ V}; I_C = 50\text{ mA}; T_{amb} = 25\text{ °C}$ | 100 | 250 | -   |      |



## 5. Pinning information

Table 2. Pinning information

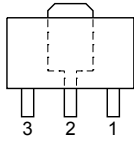
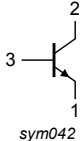
| Pin | Symbol | Description | Simplified outline  | Graphic symbol  |
|-----|--------|-------------|---|---|
| 1   | E      | emitter     |  <p style="text-align: center;"><b>SOT89</b></p> |  |
| 2   | C      | collector   |   |   |
| 3   | B      | base        |   |   |

## 6. Ordering information

Table 3. Ordering information

| Type number | Package |  |         |
|-------------|---------|--|---------|
|             | Name    | Description  | Version |
| PBHV8115X   | SOT89   | plastic surface-mounted package; die pad for good heat transfer; 3 leads | SOT89   |

## 7. Marking

Table 4. Marking codes

| Type number | Marking code |
|-------------|--------------|
| PBHV8115X   | %4F          |

[1] % = placeholder for manufacturing site code

## 8. Limiting values

**Table 5. Limiting values**

In accordance with the Absolute Maximum Rating System (IEC 60134).

| Symbol           | Parameter                 | Conditions                          |     | Min | Max  | Unit |
|------------------|---------------------------|-------------------------------------|-----|-----|------|------|
| V <sub>CBO</sub> | collector-base voltage    | open emitter                        |     | -   | 400  | V    |
| V <sub>CEO</sub> | collector-emitter voltage | open base                           |     | -   | 150  | V    |
| V <sub>EBO</sub> | emitter-base voltage      | open collector                      |     | -   | 6    | V    |
| I <sub>C</sub>   | collector current         |                                     |     | -   | 1    | A    |
| I <sub>CM</sub>  | peak collector current    | single pulse; t <sub>p</sub> ≤ 1 ms |     | -   | 2    | A    |
| I <sub>BM</sub>  | peak base current         |                                     |     | -   | 400  | mA   |
| P <sub>tot</sub> | total power dissipation   | T <sub>amb</sub> ≤ 25 °C            | [1] | -   | 0.52 | W    |
|                  |                           |                                     | [2] | -   | 1.5  | W    |
| T <sub>j</sub>   | junction temperature      |                                     |     | -   | 150  | °C   |
| T <sub>amb</sub> | ambient temperature       |                                     |     | -55 | 150  | °C   |
| T <sub>stg</sub> | storage temperature       |                                     |     | -65 | 150  | °C   |

[1] Device mounted on an FR4 PCB, single-sided copper, tin-plated and standard footprint.

[2] Device mounted on an FR4 PCB, single-sided copper, tin-plated, mounting pad for collector 6 cm<sup>2</sup>.

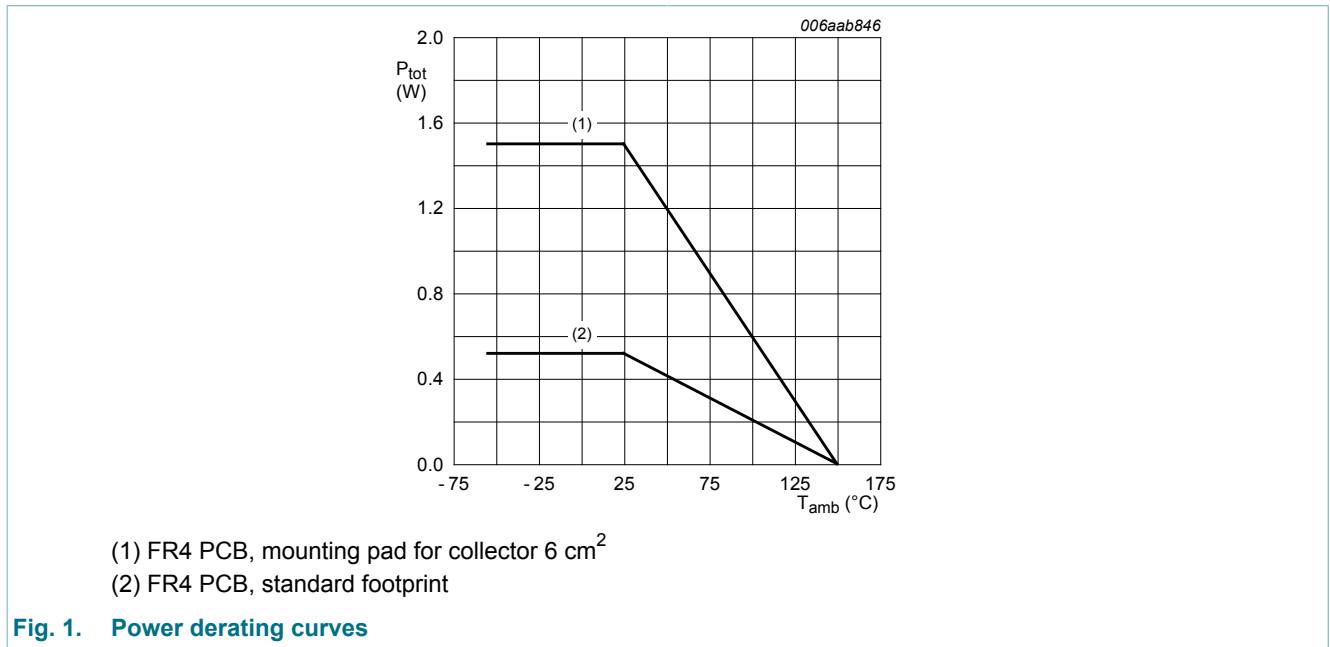

### 9. Thermal characteristics

Table 6. Thermal characteristics

| Symbol                | Parameter  | Conditions  |     | Min | Typ | Max | Unit |
|-----------------------|--|-------------|-----|-----|-----|-----|------|
| R <sub>th(j-a)</sub>  | thermal resistance from junction to ambient      | in free air | [1] | -   | -   | 240 | K/W  |
|                       |  |             | [2] | -   | -   | 83  | K/W  |
| R <sub>th(j-sp)</sub> | thermal resistance from junction to solder point |             |     | -   | -   | 20  | K/W  |

- [1] Device mounted on an FR4 PCB, single-sided copper, tin-plated and standard footprint.
- [2] Device mounted on an FR4 PCB, single-sided copper, tin-plated, mounting pad for collector 6 cm<sup>2</sup>.

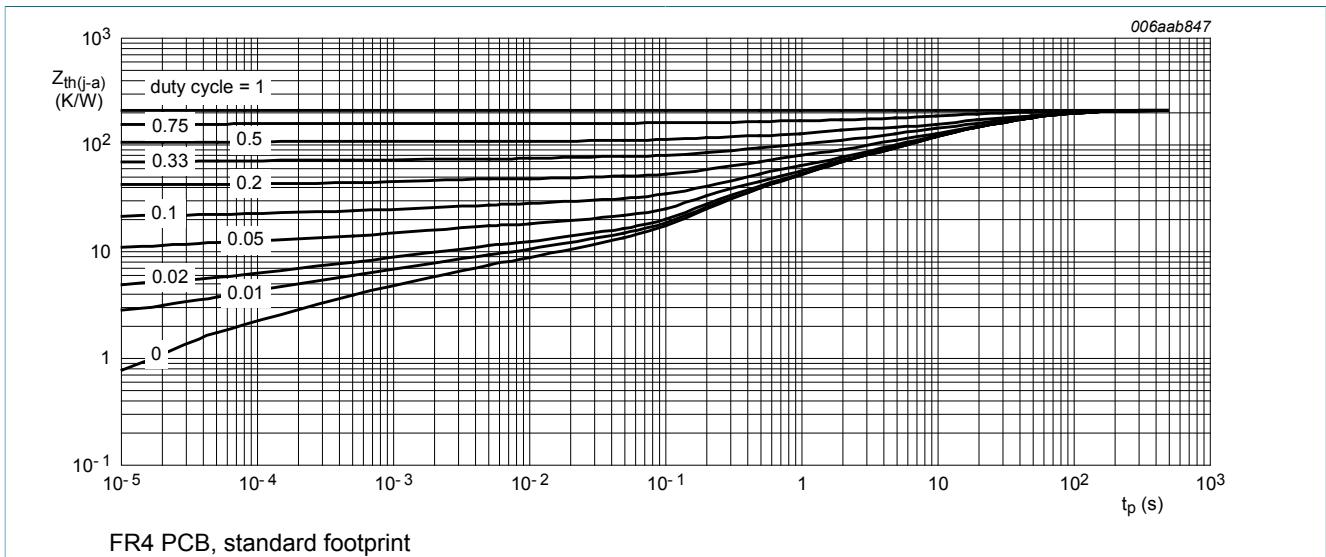

Fig. 2. Transient thermal impedance from junction to ambient as a function of pulse duration; typical values

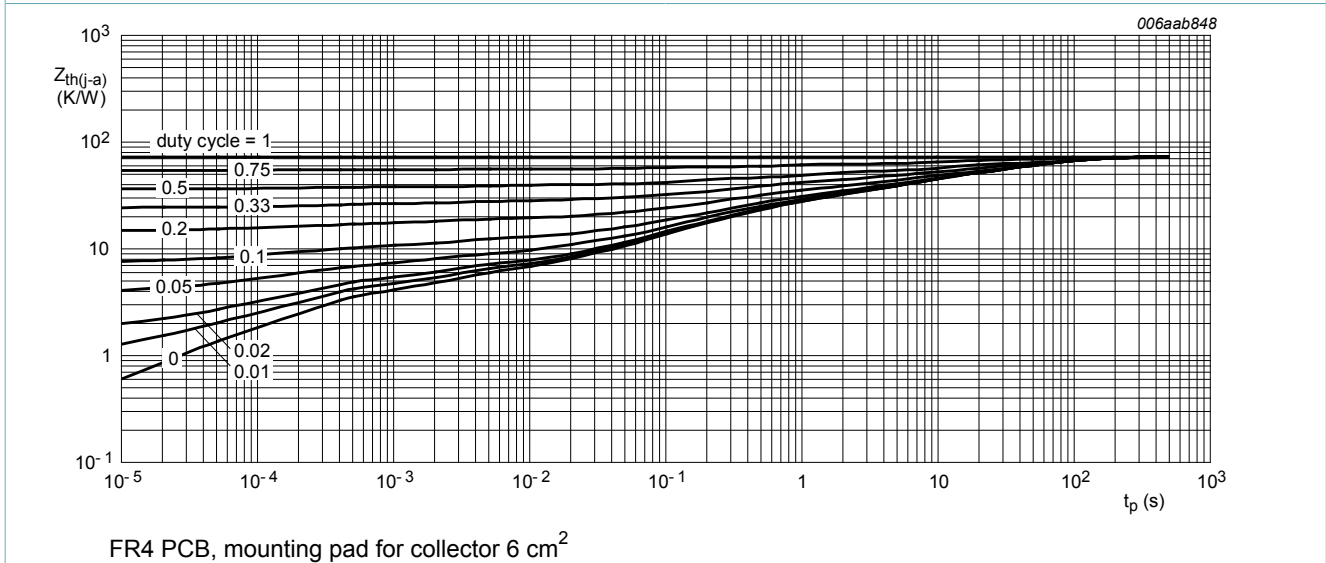

Fig. 3. Transient thermal impedance from junction to ambient as a function of pulse duration; typical values

## 10. Characteristics

Table 7. Characteristics

| Symbol             | Parameter                            | Conditions   | Min  | Typ  | Max | Unit |
|--------------------|--------------------------------------|--|--|------|-----|------|
| I <sub>CBO</sub>   | collector-base cut-off current       | V <sub>CB</sub> = 120 V; I <sub>E</sub> = 0 A; T <sub>amb</sub> = 25 °C  | -  | -    | 100 | nA   |
|                    |                                      | V <sub>CB</sub> = 120 V; I <sub>E</sub> = 0 A; T <sub>J</sub> = 150 °C   | -  | -    | 10  | μA   |
| I <sub>CES</sub>   | collector-emitter cut-off current    | V <sub>CE</sub> = 120 V; V <sub>BE</sub> = 0 V; T <sub>amb</sub> = 25 °C   | -  | -    | 100 | nA   |
| I <sub>EBO</sub>   | emitter-base cut-off current         | V <sub>EB</sub> = 4 V; I <sub>C</sub> = 0 A; T <sub>amb</sub> = 25 °C  | -  | -    | 100 | nA   |
| h <sub>FE</sub>    | DC current gain                      | V <sub>CE</sub> = 10 V; I <sub>C</sub> = 50 mA; T <sub>amb</sub> = 25 °C   | 100  | 250  | -   |      |
|                    |                                      | V <sub>CE</sub> = 10 V; I <sub>C</sub> = 100 mA; pulsed;<br>t <sub>p</sub> ≤ 300 μs; δ ≤ 0.02; T <sub>amb</sub> = 25 °C          | 100  | 250  | -   |      |
|                    |                                      | V <sub>CE</sub> = 10 V; I <sub>C</sub> = 0.5 A; pulsed;<br>t <sub>p</sub> ≤ 300 μs; δ ≤ 0.02; T <sub>amb</sub> = 25 °C           | 50   | 160  | -   |      |
|                    |                                      | V <sub>CE</sub> = 10 V; I <sub>C</sub> = 1 A; t <sub>p</sub> ≤ 300 μs;<br>δ ≤ 0.02; T <sub>amb</sub> = 25 °C                     | 10   | 30   | -   |      |
| V <sub>CEsat</sub> | collector-emitter saturation voltage | I <sub>C</sub> = 100 mA; I <sub>B</sub> = 20 mA; T <sub>amb</sub> = 25 °C  | -  | 33   | 50  | mV   |
|                    |                                      | I <sub>C</sub> = 100 mA; I <sub>B</sub> = 10 mA; T <sub>amb</sub> = 25 °C  | -  | 40   | 60  | mV   |
|                    |                                      | I <sub>C</sub> = 1 A; I <sub>B</sub> = 0.2 A; pulsed; t <sub>p</sub> ≤ 300 μs;<br>δ ≤ 0.02; T <sub>amb</sub> = 25 °C             | -  | 225  | 350 | mV   |
| V <sub>BEsat</sub> | base-emitter saturation voltage      | I <sub>C</sub> = 1 A; I <sub>B</sub> = 200 mA; pulsed;<br>t <sub>p</sub> ≤ 300 μs; δ ≤ 0.02; T <sub>amb</sub> = 25 °C            | -  | 1.1  | 1.2 | V    |
| t <sub>d</sub>     | delay time                           | V <sub>CC</sub> = 6 V; I <sub>C</sub> = 0.5 A; I <sub>Bon</sub> = 0.1 A;<br>I <sub>Boff</sub> = -0.1 A; T <sub>amb</sub> = 25 °C | -  | 7    | -   | ns   |
| t <sub>r</sub>     | rise time                            |  | -  | 565  | -   | ns   |
| t <sub>on</sub>    | turn-on time                         |  | -  | 572  | -   | ns   |
| t <sub>s</sub>     | storage time                         |  | -  | 1530 | -   | ns   |
| t <sub>f</sub>     | fall time                            |  | -  | 700  | -   | ns   |
| t <sub>off</sub>   | turn-off time                        |  | -  | 2230 | -   | ns   |
| f <sub>T</sub>     | transition frequency                 |  | V <sub>CE</sub> = 10 V; I <sub>C</sub> = 10 mA; f = 100 MHz;<br>T <sub>amb</sub> = 25 °C | -    | 30  | -    |
| C <sub>c</sub>     | collector capacitance                | V <sub>CB</sub> = 20 V; I <sub>E</sub> = 0 A; i <sub>e</sub> = 0 A;<br>f = 1 MHz; T <sub>amb</sub> = 25 °C                       | -  | 5.7  | -   | pF   |
| C <sub>e</sub>     | emitter capacitance                  | V <sub>EB</sub> = 0.5 V; I <sub>C</sub> = 0 A; i <sub>c</sub> = 0 A;<br>f = 1 MHz; T <sub>amb</sub> = 25 °C                      | -  | 150  | -   | pF   |

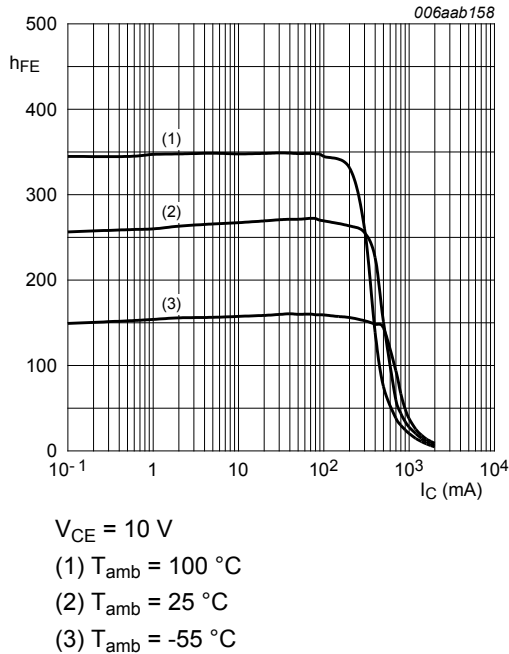

Fig. 4. DC current gain as a function of collector current; typical values

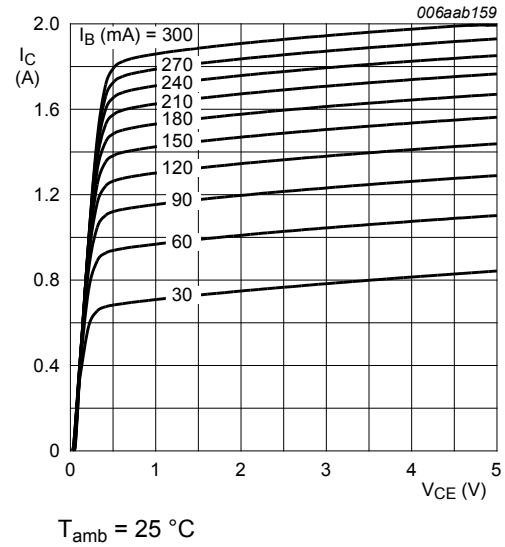

Fig. 5. Collector current as a function of collector-emitter voltage; typical values

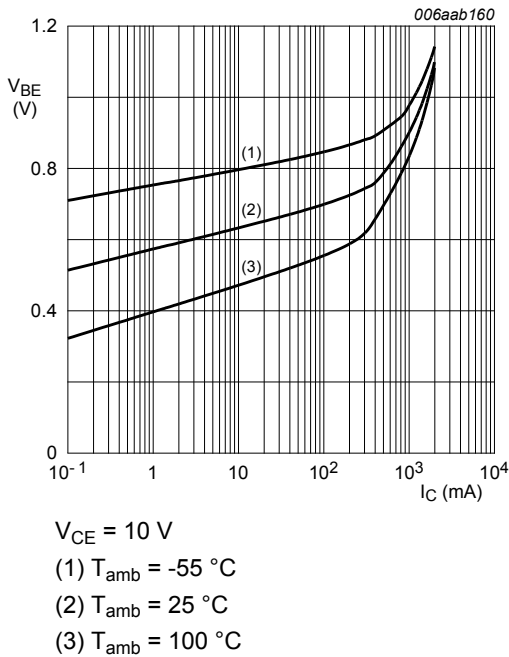

Fig. 6. Base-emitter voltage as a function of collector current; typical values

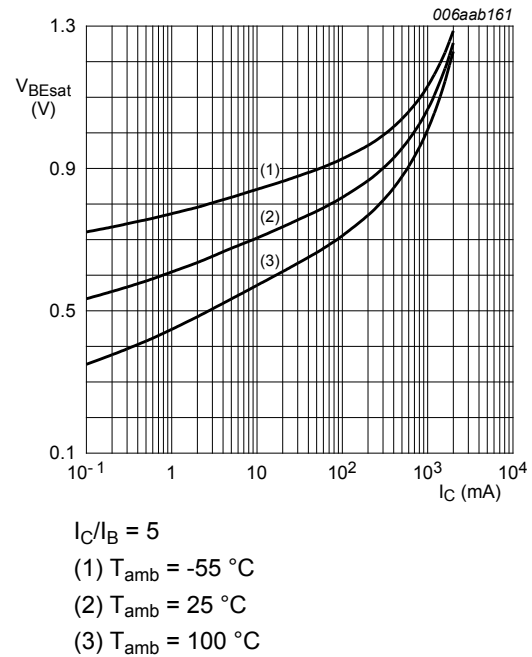
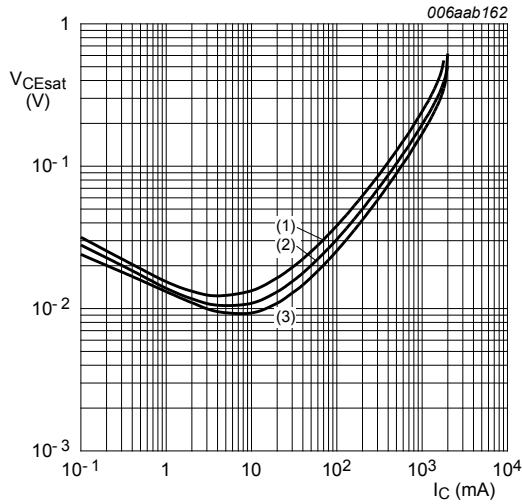
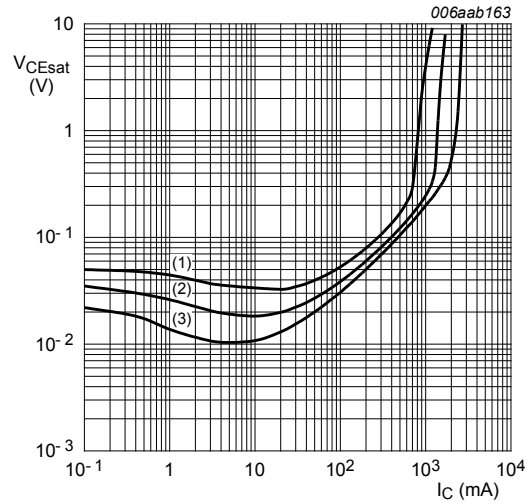

Fig. 7. Base-emitter saturation voltage as a function of collector current; typical values



$I_C/I_B = 5$   
 (1)  $T_{amb} = 100\text{ }^\circ\text{C}$   
 (2)  $T_{amb} = 25\text{ }^\circ\text{C}$   
 (3)  $T_{amb} = -55\text{ }^\circ\text{C}$

**Fig. 8. Collector-emitter saturation voltage as a function of collector current; typical values**



$T_{amb} = 25\text{ }^\circ\text{C}$   
 (1)  $I_C/I_B = 20$   
 (2)  $I_C/I_B = 10$   
 (3)  $I_C/I_B = 5$

**Fig. 9. Collector-emitter saturation voltage as a function of collector current; typical values**

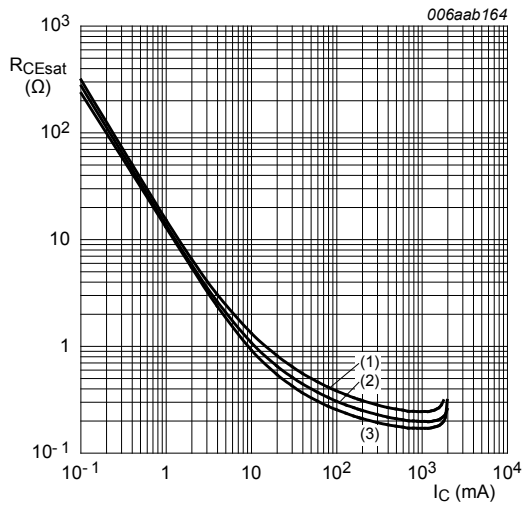

$I_C/I_B = 5$   
 (1)  $T_{amb} = 100\text{ }^\circ\text{C}$   
 (2)  $T_{amb} = 25\text{ }^\circ\text{C}$   
 (3)  $T_{amb} = -55\text{ }^\circ\text{C}$

**Fig. 10. Collector-emitter saturation resistance as a function of collector current; typical values**

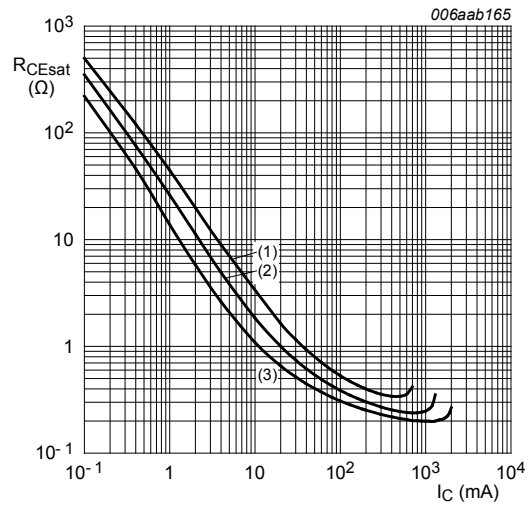

$T_{amb} = 25\text{ }^\circ\text{C}$   
 (1)  $I_C/I_B = 20$   
 (2)  $I_C/I_B = 10$   
 (3)  $I_C/I_B = 5$

**Fig. 11. Collector-emitter saturation resistance as a function of collector current; typical values**



### 11. Test information

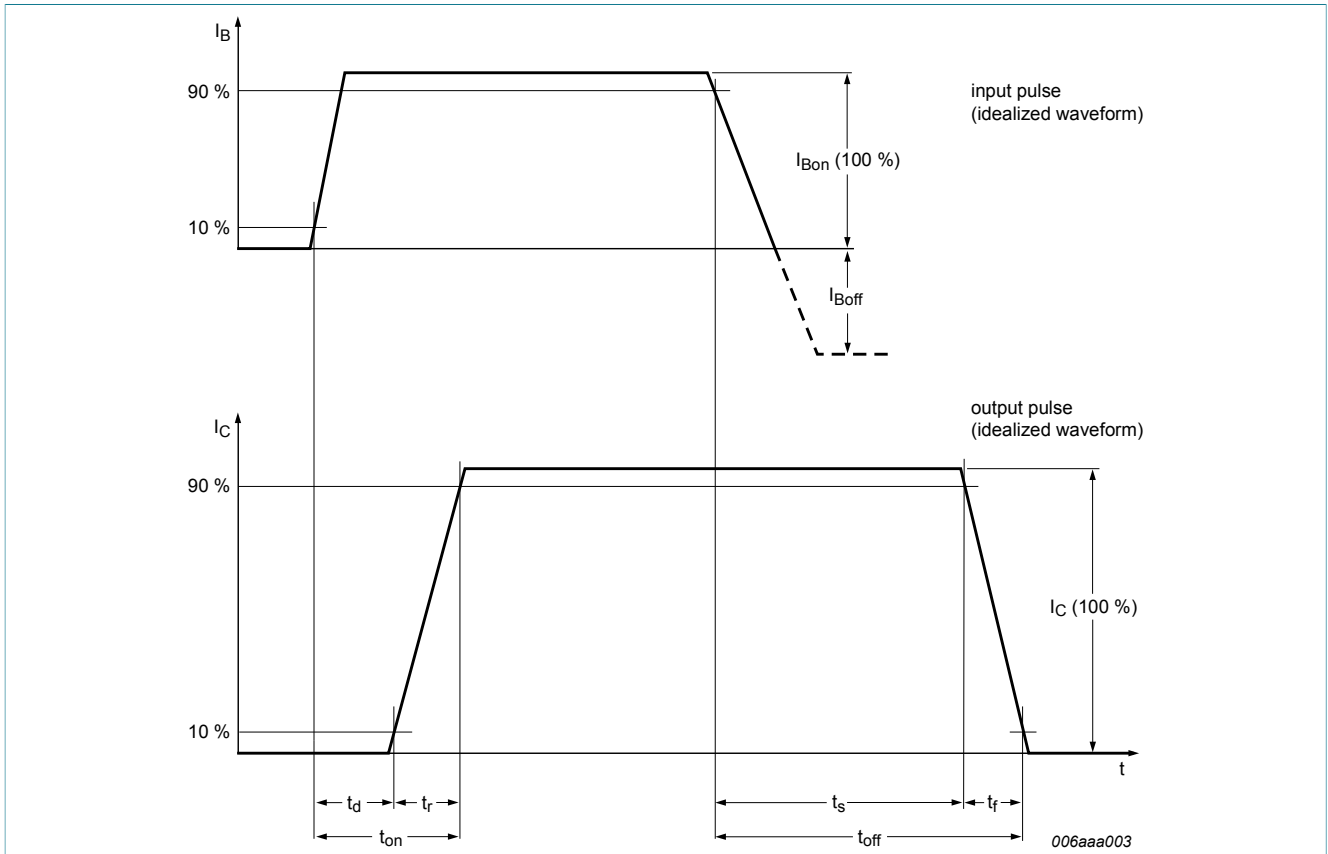

Fig. 12. BISS transistor switching time definition

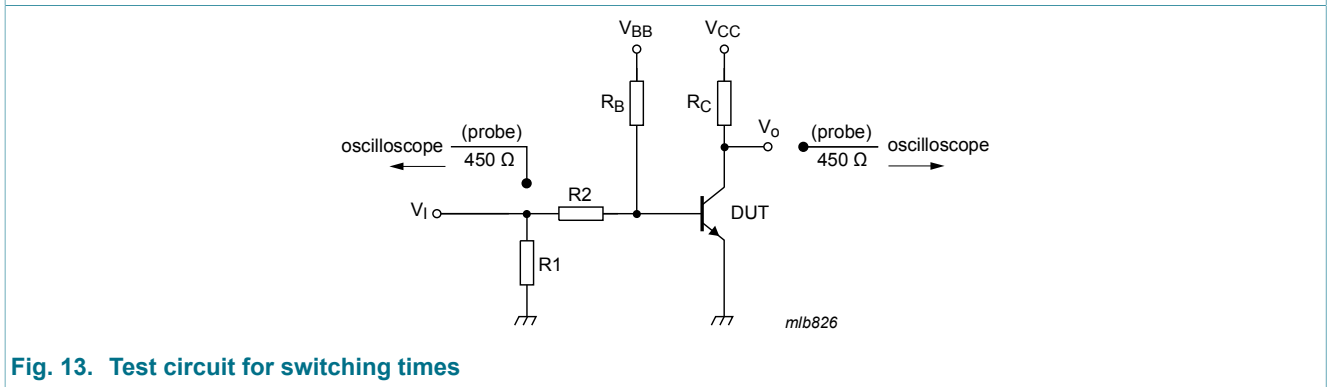

Fig. 13. Test circuit for switching times

#### 11.1 Quality information

This product has been qualified in accordance with the Automotive Electronics Council (AEC) standard Q101 - Stress test qualification for discrete semiconductors, and is suitable for use in automotive applications.

## 12. Package outline

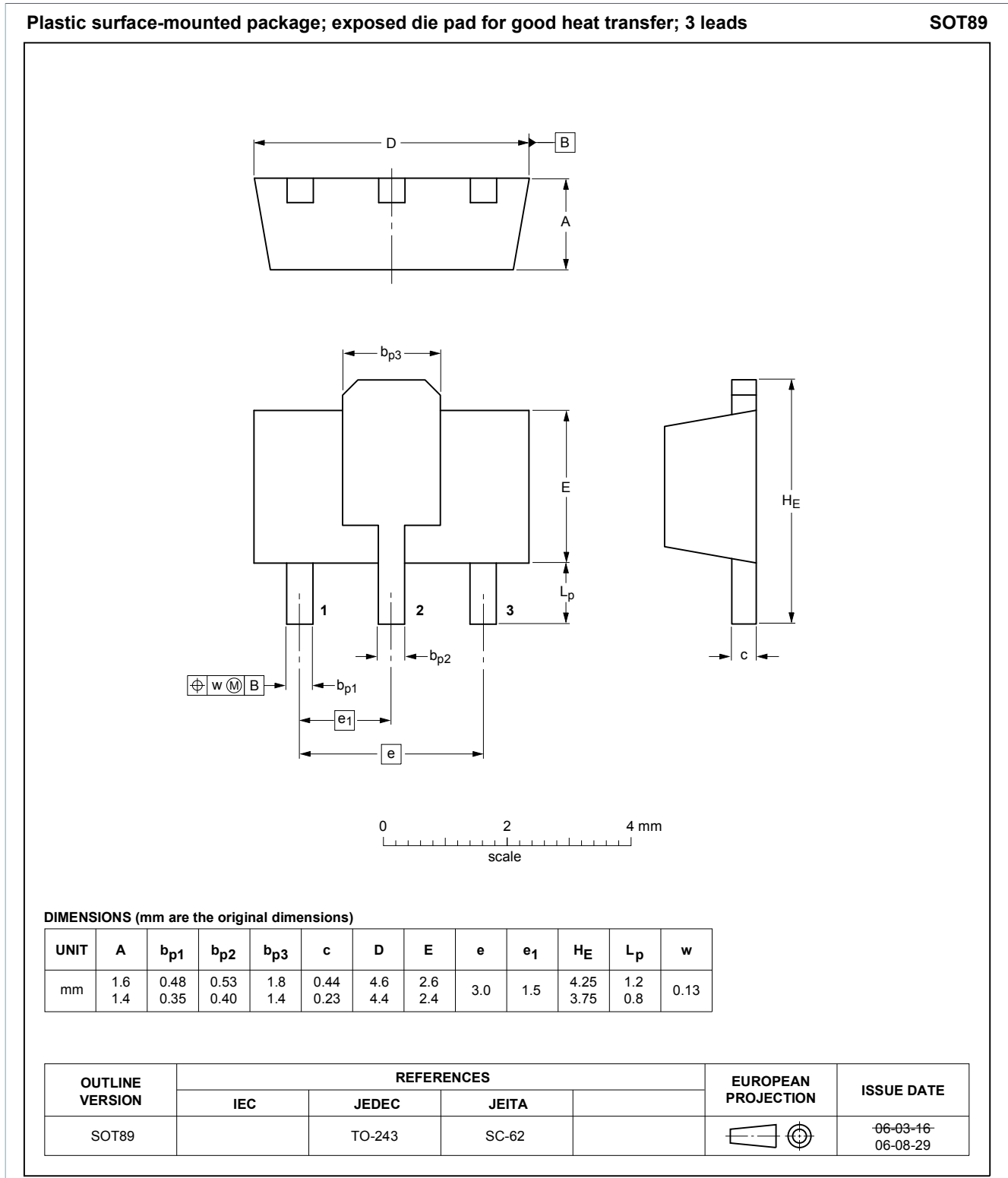

Fig. 14. Package outline SOT89

### 13. Soldering

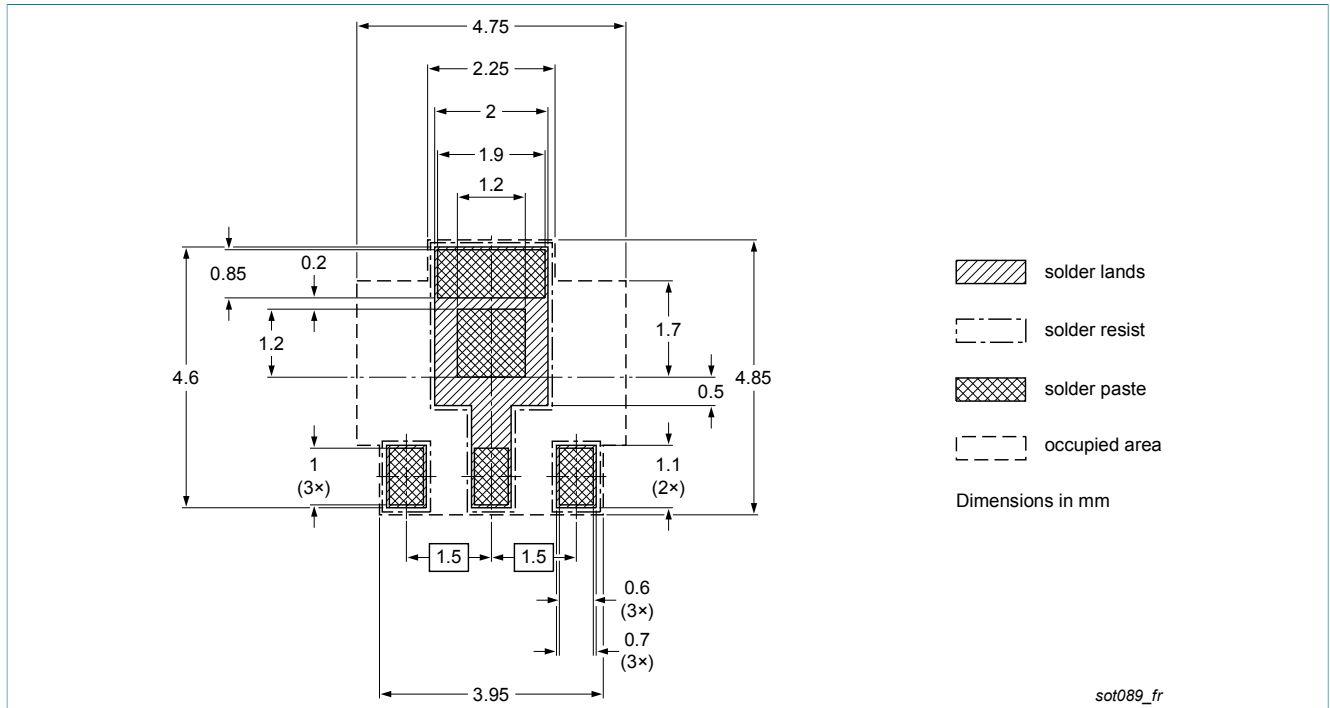

Fig. 15. Reflow soldering footprint for SOT89

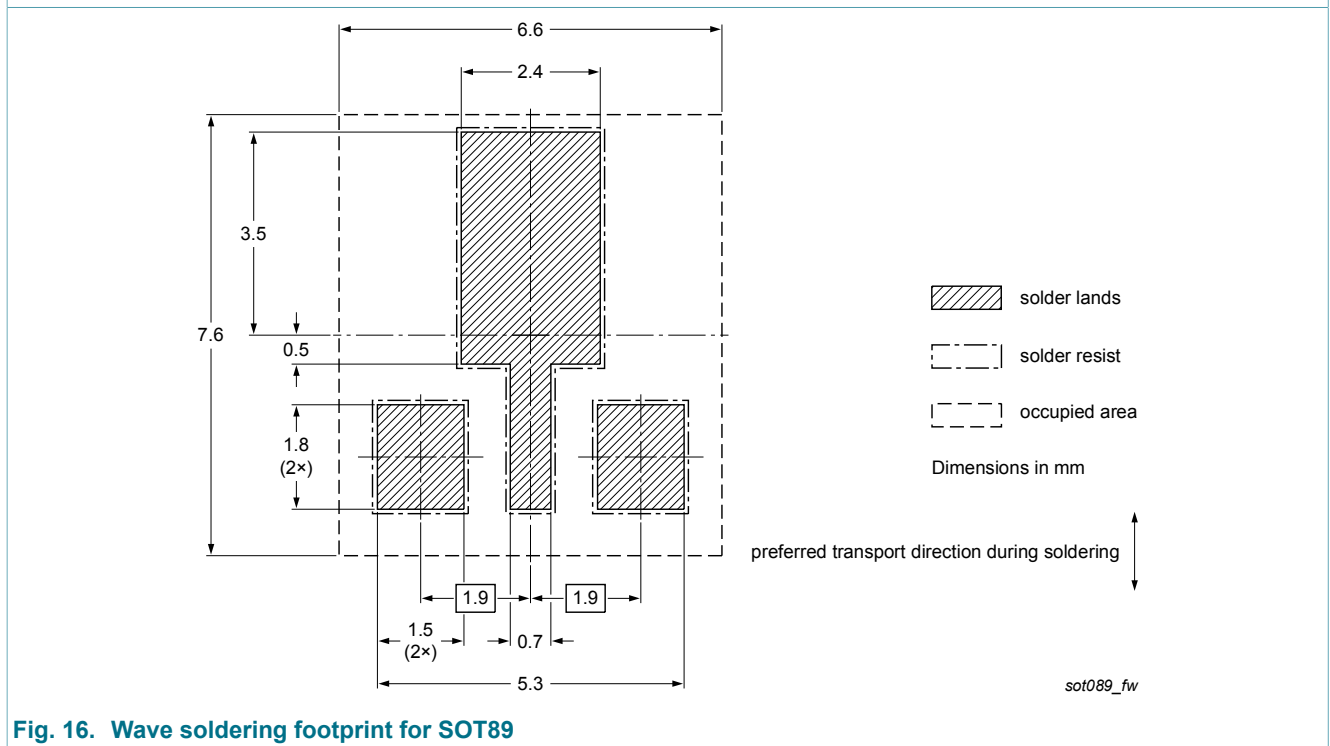

Fig. 16. Wave soldering footprint for SOT89

## 14. Revision history

Table 8. Revision history

| Data sheet ID | Release date | Data sheet status  | Change notice | Supersedes |
|---------------|--------------|--------------------|---------------|------------|
| PBHV8115X v.1 | 20131209     | Product data sheet | -             | -          |

## 15. Legal information

### 15.1 Data sheet status

| Document status [1][2]         | Product status [3] | Definition  |
|--------------------------------|--------------------|---|
| Objective [short] data sheet   | Development        | This document contains data from the objective specification for product development. |
| Preliminary [short] data sheet | Qualification      | This document contains data from the preliminary specification.                       |
| Product [short] data sheet     | Production         | This document contains the product specification.                                     |

- [1] Please consult the most recently issued document before initiating or completing a design.
- [2] The term 'short data sheet' is explained in section "Definitions".
- [3] The product status of device(s) described in this document may have changed since this document was published and may differ in case of multiple devices. The latest product status information is available on the Internet at URL <http://www.nxp.com>.

### 15.2 Definitions

**Preview** — The document is a preview version only. The document is still subject to formal approval, which may result in modifications or additions. NXP Semiconductors does not give any representations or warranties as to the accuracy or completeness of information included herein and shall have no liability for the consequences of use of such information.

**Draft** — The document is a draft version only. The content is still under internal review and subject to formal approval, which may result in modifications or additions. NXP Semiconductors does not give any representations or warranties as to the accuracy or completeness of information included herein and shall have no liability for the consequences of use of such information.

**Short data sheet** — A short data sheet is an extract from a full data sheet with the same product type number(s) and title. A short data sheet is intended for quick reference only and should not be relied upon to contain detailed and full information. For detailed and full information see the relevant full data sheet, which is available on request via the local NXP Semiconductors sales office. In case of any inconsistency or conflict with the short data sheet, the full data sheet shall prevail.

**Product specification** — The information and data provided in a Product data sheet shall define the specification of the product as agreed between NXP Semiconductors and its customer, unless NXP Semiconductors and customer have explicitly agreed otherwise in writing. In no event however, shall an agreement be valid in which the NXP Semiconductors product is deemed to offer functions and qualities beyond those described in the Product data sheet.

### 15.3 Disclaimers

**Limited warranty and liability** — Information in this document is believed to be accurate and reliable. However, NXP Semiconductors does not give any representations or warranties, expressed or implied, as to the accuracy or completeness of such information and shall have no liability for the consequences of use of such information. NXP Semiconductors takes no responsibility for the content in this document if provided by an information source outside of NXP Semiconductors.

In no event shall NXP Semiconductors be liable for any indirect, incidental, punitive, special or consequential damages (including - without limitation - lost profits, lost savings, business interruption, costs related to the removal or replacement of any products or rework charges) whether or not such damages are based on tort (including negligence), warranty, breach of contract or any other legal theory.

Notwithstanding any damages that customer might incur for any reason whatsoever, NXP Semiconductors' aggregate and cumulative liability towards customer for the products described herein shall be limited in accordance with the *Terms and conditions of commercial sale* of NXP Semiconductors.

**Right to make changes** — NXP Semiconductors reserves the right to make changes to information published in this document, including without limitation specifications and product descriptions, at any time and without notice. This document supersedes and replaces all information supplied prior to the publication hereof.

**Suitability for use in automotive applications** — This NXP Semiconductors product has been qualified for use in automotive applications. Unless otherwise agreed in writing, the product is not designed, authorized or warranted to be suitable for use in life support, life-critical or safety-critical systems or equipment, nor in applications where failure or malfunction of an NXP Semiconductors product can reasonably be expected to result in personal injury, death or severe property or environmental damage. NXP Semiconductors and its suppliers accept no liability for inclusion and/or use of NXP Semiconductors products in such equipment or applications and therefore such inclusion and/or use is at the customer's own risk.

**Quick reference data** — The Quick reference data is an extract of the product data given in the Limiting values and Characteristics sections of this document, and as such is not complete, exhaustive or legally binding.

**Applications** — Applications that are described herein for any of these products are for illustrative purposes only. NXP Semiconductors makes no representation or warranty that such applications will be suitable for the specified use without further testing or modification.

Customers are responsible for the design and operation of their applications and products using NXP Semiconductors products, and NXP Semiconductors accepts no liability for any assistance with applications or customer product design. It is customer's sole responsibility to determine whether the NXP Semiconductors product is suitable and fit for the customer's applications and products planned, as well as for the planned application and use of customer's third party customer(s). Customers should provide appropriate design and operating safeguards to minimize the risks associated with their applications and products.

NXP Semiconductors does not accept any liability related to any default, damage, costs or problem which is based on any weakness or default in the customer's applications or products, or the application or use by customer's third party customer(s). Customer is responsible for doing all necessary testing for the customer's applications and products using NXP Semiconductors products in order to avoid a default of the applications and the products or of the application or use by customer's third party customer(s). NXP does not accept any liability in this respect.

**Limiting values** — Stress above one or more limiting values (as defined in the Absolute Maximum Ratings System of IEC 60134) will cause permanent damage to the device. Limiting values are stress ratings only and (proper) operation of the device at these or any other conditions above those given in the Recommended operating conditions section (if present) or the Characteristics sections of this document is not warranted. Constant or repeated exposure to limiting values will permanently and irreversibly affect the quality and reliability of the device.

**Terms and conditions of commercial sale** — NXP Semiconductors products are sold subject to the general terms and conditions of commercial sale, as published at <http://www.nxp.com/profile/terms>, unless otherwise agreed in a valid written individual agreement. In case an individual agreement is concluded only the terms and conditions of the respective agreement shall apply. NXP Semiconductors hereby expressly objects to applying the customer's general terms and conditions with regard to the purchase of NXP Semiconductors products by customer.

**No offer to sell or license** — Nothing in this document may be interpreted or construed as an offer to sell products that is open for acceptance or the grant, conveyance or implication of any license under any copyrights, patents or other industrial or intellectual property rights.

**Export control** — This document as well as the item(s) described herein may be subject to export control regulations. Export might require a prior authorization from competent authorities.

**Translations** — A non-English (translated) version of a document is for reference only. The English version shall prevail in case of any discrepancy between the translated and English versions.

## 15.4 Trademarks

Notice: All referenced brands, product names, service names and trademarks are the property of their respective owners.

**Adelante, Bitport, Bitsound, CoolFlux, CoReUse, DESFire, EZ-HV, FabKey, GreenChip, HiPerSmart, HITAG, I<sup>2</sup>C-bus logo, ICODE, I-CODE, ITEC, Labelution, MIFARE, MIFARE Plus, MIFARE Ultralight, MoReUse, QLPAK, Silicon Tuner, SiliconMAX, SmartXA, STARplug, TOPFET, TrenchMOS, TriMedia and UCODE** — are trademarks of NXP B.V.

**HD Radio** and **HD Radio** logo — are trademarks of iBiquity Digital Corporation.

## 16. Contents

|      |                               |    |
|------|-------------------------------|----|
| 1    | General description .....     | 1  |
| 2    | Features and benefits .....   | 1  |
| 3    | Applications .....            | 1  |
| 4    | Quick reference data .....    | 1  |
| 5    | Pinning information .....     | 2  |
| 6    | Ordering information .....    | 2  |
| 7    | Marking .....                 | 2  |
| 8    | Limiting values .....         | 3  |
| 9    | Thermal characteristics ..... | 4  |
| 10   | Characteristics .....         | 5  |
| 11   | Test information .....        | 8  |
| 11.1 | Quality information .....     | 8  |
| 12   | Package outline .....         | 9  |
| 13   | Soldering .....               | 10 |
| 14   | Revision history .....        | 11 |
| 15   | Legal information .....       | 12 |
| 15.1 | Data sheet status .....       | 12 |
| 15.2 | Definitions .....             | 12 |
| 15.3 | Disclaimers .....             | 12 |
| 15.4 | Trademarks .....              | 13 |

---

© NXP N.V. 2013. All rights reserved

For more information, please visit: <http://www.nxp.com>

For sales office addresses, please send an email to: [salesaddresses@nxp.com](mailto:salesaddresses@nxp.com)

Date of release: 9 December 2013

---

Компания «Life Electronics» занимается поставками электронных компонентов импортного и отечественного производства от производителей и со складов крупных дистрибьюторов Европы, Америки и Азии.

С конца 2013 года компания активно расширяет линейку поставок компонентов по направлению коаксиальный кабель, кварцевые генераторы и конденсаторы (керамические, пленочные, электролитические), за счёт заключения дистрибьюторских договоров

Мы предлагаем:

- Конкурентоспособные цены и скидки постоянным клиентам.
- Специальные условия для постоянных клиентов.
- Подбор аналогов.
- Поставку компонентов в любых объемах, удовлетворяющих вашим потребностям.
- Приемлемые сроки поставки, возможна ускоренная поставка.
- Доставку товара в любую точку России и стран СНГ.
- Комплексную поставку.
- Работу по проектам и поставку образцов.
- Формирование склада под заказчика.
- Сертификаты соответствия на поставляемую продукцию (по желанию клиента).
- Тестирование поставляемой продукции.
- Поставку компонентов, требующих военную и космическую приемку.
- Входной контроль качества.
- Наличие сертификата ISO.

В составе нашей компании организован Конструкторский отдел, призванный помогать разработчикам, и инженерам.

Конструкторский отдел помогает осуществить:

- Регистрацию проекта у производителя компонентов.
- Техническую поддержку проекта.
- Защиту от снятия компонента с производства.
- Оценку стоимости проекта по компонентам.
- Изготовление тестовой платы монтаж и пусконаладочные работы.



Тел: +7 (812) 336 43 04 (многоканальный)

Email: [org@lifeelectronics.ru](mailto:org@lifeelectronics.ru)

[www.lifeelectronics.ru](http://www.lifeelectronics.ru)