

Glass Passivated Single-Phase Bridge Rectifier

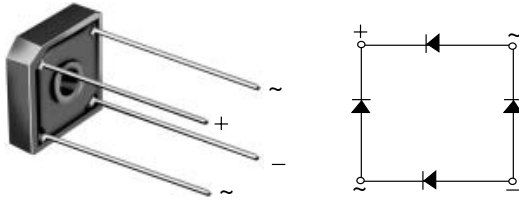

Case Style GBPC6

PRIMARY CHARACTERISTICS	
$I_{F(AV)}$	6 A
V_{RRM}	50 V to 1000 V
I_{FSM}	175 A
I_R	5 μ A
V_F	1.0 V
T_J max.	150 °C

FEATURES

- UL recognition file number E54214
- Ideal for printed circuit boards
- Typical I_R less than 0.5 μ A
- High surge current capability
- High case dielectric strength 1500 V_{RMS}
- Solder dip 260 °C, 40 s
- Component in accordance to RoHS 2002/95/EC and WEEE 2002/96/EC

RoHS
COMPLIANT

TYPICAL APPLICATIONS

General purpose use in ac-to-dc bridge full wave rectification for power supply, home appliances, office equipment, industrial automation applications.

MECHANICAL DATA

Case: GBPC6

Epoxy meets UL 94V-0 flammability rating

Terminals: Silver plated leads, solderable per J-STD-002 and JESD22-B102

E4 suffix for consumer grade

Polarity: As marked, positive lead by beveled corner

Mounting Torque: 10 cm-kg (8.8 inches-lbs) max.

Recommended Torque: 5.7 cm-kg (5 inches-lbs)

MAXIMUM RATINGS ($T_A = 25$ °C unless otherwise noted)									
PARAMETER	SYMBOL	GBPC 6005	GBPC 601	GBPC 602	GBPC 604	GBPC 606	GBPC 608	GBPC 610	UNIT
Maximum repetitive peak reverse voltage	V_{RRM}	50	100	200	400	600	800	1000	V
Maximum RMS bridge input voltage	V_{RMS}	35	70	140	280	420	560	700	V
Maximum DC blocking voltage	V_{DC}	50	100	200	400	600	800	1000	V
Maximum average forward rectified output current at $T_C = 50$ °C ⁽¹⁾⁽²⁾ $T_A = 40$ °C ⁽³⁾	$I_{F(AV)}$	6.0 3.0							A
Peak forward surge current single sine-wave superimposed on rated load	I_{FSM}	175							A
Rating for fusing ($t < 8.3$ ms)	I^2t	127							A ² s
Operating junction and storage temperature range	T_J, T_{STG}	- 55 to + 150							°C

Notes:

- (1) Bolt down on heat-sink with silicone thermal compound between bridge and mounting surface for maximum heat transfer with #6 screw
- (2) Unit mounted on 5.5 x 6.0 x 0.11" thick (14 x 15 x 0.3 cm) aluminum plate
- (3) Unit mounted on P.C.B. at 0.375" (9.5 mm) lead length with 0.5 x 0.5" (12 x 12 mm) copper pads

ELECTRICAL CHARACTERISTICS ($T_A = 25\text{ }^\circ\text{C}$ unless otherwise noted)											
PARAMETER	TEST CONDITIONS	SYMBOL	GBPC 6005	GBPC 601	GBPC 602	GBPC 604	GBPC 606	GBPC 608	GBPC 610	UNIT	
Maximum instantaneous forward voltage drop per diode	3.0 A	V_F	1.0								V
Maximum DC reverse current at rated DC blocking voltage per diode	$T_A = 25\text{ }^\circ\text{C}$ $T_A = 125\text{ }^\circ\text{C}$	I_R	5.0 500								μA
Typical junction capacitance per diode	4.0 V, 1 MHz	C_J	186				90				pF

THERMAL CHARACTERISTICS ($T_A = 25\text{ }^\circ\text{C}$ unless otherwise noted)										
PARAMETER	SYMBOL	GBPC 6005	GBPC 601	GBPC 602	GBPC 604	GBPC 606	GBPC 608	GBPC 610	UNIT	
Typical thermal resistance ⁽¹⁾	$R_{\theta JA}$ $R_{\theta JC}$	22 7.3								$^\circ\text{C/W}$

Notes:

- (1) Bolt down on heat-sink with silicone thermal compound between bridge and mounting surface for maximum heat transfer with #6 screw
- (2) Unit mounted on 5.5 x 6.0 x 0.11" thick (14 x 15 x 0.3 cm) aluminum plate
- (3) Unit mounted on P.C.B. at 0.375" (9.5 mm) lead length with 0.5 x 0.5" (12 x 12 mm) copper pads

ORDERING INFORMATION (Example)				
PREFERRED P/N	UNIT WEIGHT (g)	PREFERRED PACKAGE CODE	BASE QUANTITY	DELIVERY MODE
GBPC606-E4/51	3.2	51	100	Paper box

RATINGS AND CHARACTERISTICS CURVES

($T_A = 25\text{ }^\circ\text{C}$ unless otherwise noted)

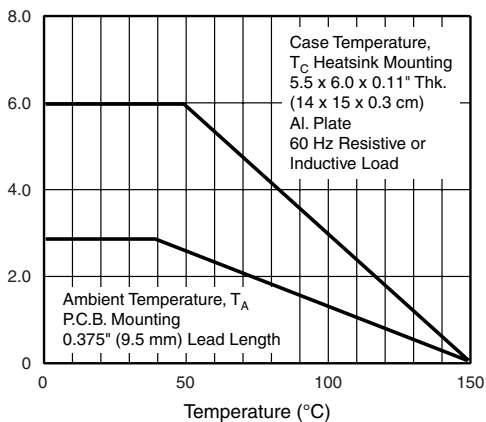

Figure 1. Derating Curve Output Rectified Current

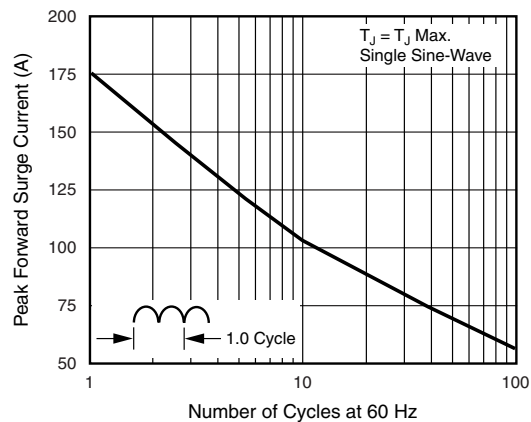

Figure 2. Maximum Non-Repetitive Peak Forward Surge Current Per Diode

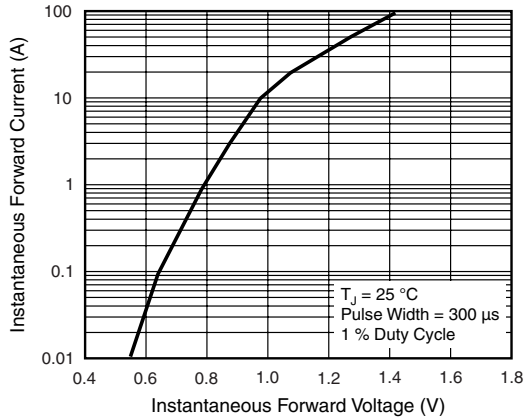

Figure 3. Typical Forward Characteristics Per Diode

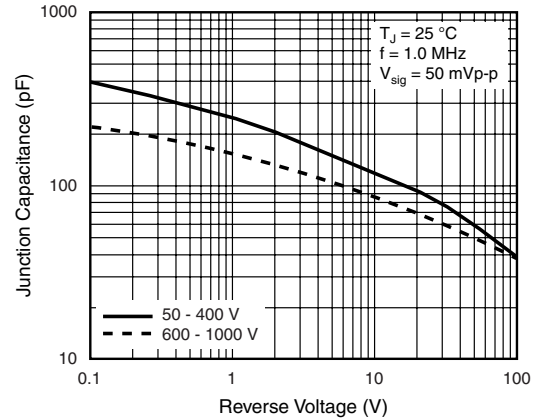

Figure 5. Typical Junction Capacitance Per Diode

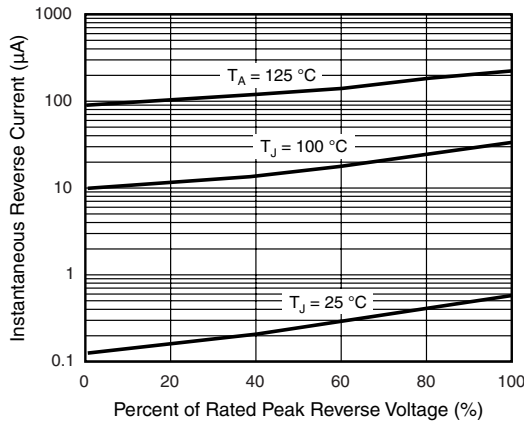

Figure 4. Typical Reverse Leakage Characteristics Per Diode

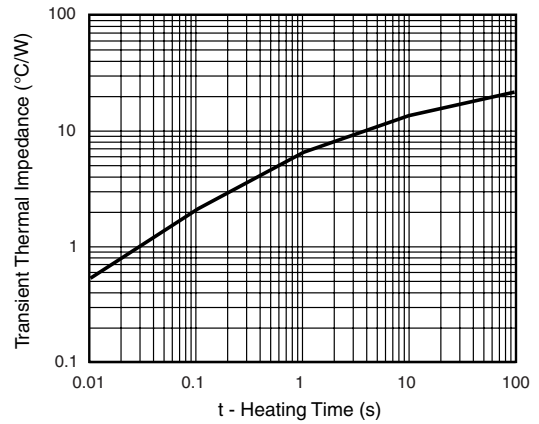
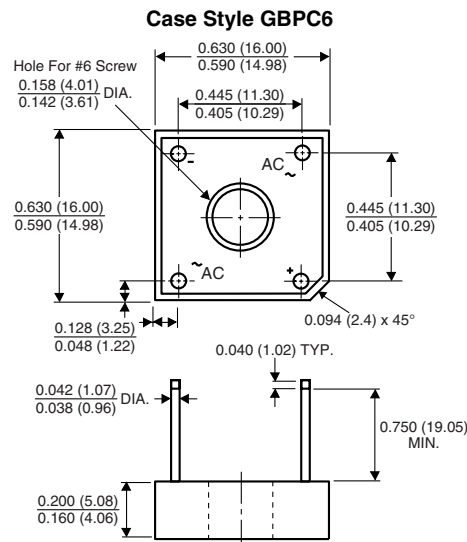

Figure 6. Typical Transient Thermal Impedance Per Diode

PACKAGE OUTLINE DIMENSIONS in inches (millimeters)



Polarity shown on side of case: Positive lead by beveled corner



Disclaimer

ALL PRODUCT, PRODUCT SPECIFICATIONS AND DATA ARE SUBJECT TO CHANGE WITHOUT NOTICE TO IMPROVE RELIABILITY, FUNCTION OR DESIGN OR OTHERWISE.

Vishay Intertechnology, Inc., its affiliates, agents, and employees, and all persons acting on its or their behalf (collectively, "Vishay"), disclaim any and all liability for any errors, inaccuracies or incompleteness contained in any datasheet or in any other disclosure relating to any product.

Vishay makes no warranty, representation or guarantee regarding the suitability of the products for any particular purpose or the continuing production of any product. To the maximum extent permitted by applicable law, Vishay disclaims (i) any and all liability arising out of the application or use of any product, (ii) any and all liability, including without limitation special, consequential or incidental damages, and (iii) any and all implied warranties, including warranties of fitness for particular purpose, non-infringement and merchantability.

Statements regarding the suitability of products for certain types of applications are based on Vishay's knowledge of typical requirements that are often placed on Vishay products in generic applications. Such statements are not binding statements about the suitability of products for a particular application. It is the customer's responsibility to validate that a particular product with the properties described in the product specification is suitable for use in a particular application. Parameters provided in datasheets and/or specifications may vary in different applications and performance may vary over time. All operating parameters, including typical parameters, must be validated for each customer application by the customer's technical experts. Product specifications do not expand or otherwise modify Vishay's terms and conditions of purchase, including but not limited to the warranty expressed therein.

Except as expressly indicated in writing, Vishay products are not designed for use in medical, life-saving, or life-sustaining applications or for any other application in which the failure of the Vishay product could result in personal injury or death. Customers using or selling Vishay products not expressly indicated for use in such applications do so at their own risk and agree to fully indemnify and hold Vishay and its distributors harmless from and against any and all claims, liabilities, expenses and damages arising or resulting in connection with such use or sale, including attorneys fees, even if such claim alleges that Vishay or its distributor was negligent regarding the design or manufacture of the part. Please contact authorized Vishay personnel to obtain written terms and conditions regarding products designed for such applications.

No license, express or implied, by estoppel or otherwise, to any intellectual property rights is granted by this document or by any conduct of Vishay. Product names and markings noted herein may be trademarks of their respective owners.

Material Category Policy

Vishay Intertechnology, Inc. hereby certifies that all its products that are identified as RoHS-Compliant fulfill the definitions and restrictions defined under Directive 2011/65/EU of The European Parliament and of the Council of June 8, 2011 on the restriction of the use of certain hazardous substances in electrical and electronic equipment (EEE) - recast, unless otherwise specified as non-compliant.

Please note that some Vishay documentation may still make reference to RoHS Directive 2002/95/EC. We confirm that all the products identified as being compliant to Directive 2002/95/EC conform to Directive 2011/65/EU.

Компания «Life Electronics» занимается поставками электронных компонентов импортного и отечественного производства от производителей и со складов крупных дистрибьюторов Европы, Америки и Азии.

С конца 2013 года компания активно расширяет линейку поставок компонентов по направлению коаксиальный кабель, кварцевые генераторы и конденсаторы (керамические, пленочные, электролитические), за счёт заключения дистрибьюторских договоров

Мы предлагаем:

- Конкуренспособные цены и скидки постоянным клиентам.
- Специальные условия для постоянных клиентов.
- Подбор аналогов.
- Поставку компонентов в любых объемах, удовлетворяющих вашим потребностям.
- Приемлемые сроки поставки, возможна ускоренная поставка.
- Доставку товара в любую точку России и стран СНГ.
- Комплексную поставку.
- Работу по проектам и поставку образцов.
- Формирование склада под заказчика.
- Сертификаты соответствия на поставляемую продукцию (по желанию клиента).
- Тестирование поставляемой продукции.
- Поставку компонентов, требующих военную и космическую приемку.
- Входной контроль качества.
- Наличие сертификата ISO.

В составе нашей компании организован Конструкторский отдел, призванный помогать разработчикам, и инженерам.

Конструкторский отдел помогает осуществить:

- Регистрацию проекта у производителя компонентов.
- Техническую поддержку проекта.
- Защиту от снятия компонента с производства.
- Оценку стоимости проекта по компонентам.
- Изготовление тестовой платы монтаж и пусконаладочные работы.



Тел: +7 (812) 336 43 04 (многоканальный)

Email: org@lifeelectronics.ru