

# W

## Woodhead

**SAFETY PERFORMANCE RELIABILITY**





# THIS BUYER'S GUIDE IS JUST THE BEGINNING

## **Custom product solutions for tough applications are a tradition at Woodhead.**

In the pages ahead, you'll find products that serve many common applications. What you won't see are all of the thousands of products we are capable of producing, and have built in the past, to meet more specific needs. Customized products that involved the expertise of our design engineering staff. Products designed for specific regions of the world, in hazardous, wet and highly regulated environments.

Whether it's a brighter handlamp or a smaller wiring device, if what you're looking for isn't depicted here, give us a call. Chances are, we've already developed and produced the item you need. And if we haven't, we'd be happy to explore the possibility with you.



## TABLE OF CONTENTS

### **PORTABLE LIGHTING 4-43**

|                                |       |
|--------------------------------|-------|
| Hand Lamps .....               | 6-25  |
| Wide Area Lamps .....          | 26-33 |
| Temporary Lighting .....       | 34-40 |
| Lighting and Accessories ..... | 41-43 |

### **WIRING DEVICES 44-129**

|                                  |         |
|----------------------------------|---------|
| Key Product Selector Guide ..... | 46-47   |
| 15 Amp .....                     | 48-67   |
| 20 Amp .....                     | 68-95   |
| 30 Amp .....                     | 96-111  |
| 50 Amp .....                     | 112-115 |
| Pin and Sleeve .....             | 116-119 |
| Adapters .....                   | 122     |
| Grommets .....                   | 123     |
| Technical Reference .....        | 124-127 |

### **PORTABLE OUTLET BOXES 130-151**

|                        |          |
|------------------------|----------|
| GFCI's .....           | 132-139  |
| Pendants .....         | 139, 143 |
| Multiple Outlets ..... | 140-151  |

### **CABLE GRIPS 152-187**

|  |         |
|--|---------|
| Strain Relief Grips .....                | 154-163 |
| Support Grips .....                      | 164-173 |
| Pulling Grips .....                      | 174-183 |
| Technical Reference .....                | 184-187 |
| Grips Competitive Comparison Index ..... | 244-247 |

### **ELECTRIC CORD AND CABLE REELS 188-205**

|   |         |
|---|---------|
| Standard Duty Reels & Accessories .....   | 190-193 |
| Industrial Duty Reels & Accessories ..... | 194-197 |
| Heavy Duty Reels & Accessories .....      | 198-199 |
| Festoon Cable Carrying Systems .....      | 200-201 |
| Hand Wind Reels .....                     | 202-203 |
| Technical Reference .....                 | 204-205 |

### **PUSHBUTTONS, INSTRUMENTS 206-219**

|                           |         |
|---------------------------|---------|
| Pendant Stations .....    | 208-213 |
| Test Instruments .....    | 214-215 |
| Grounding Products .....  | 216-217 |
| Technical Reference ..... | 218-219 |

### **BRAD HARRISON® PASSIVE MEDIA 220-243**

|                     |         |
|---------------------|---------|
| Mini-change® .....  | 222-229 |
| Micro-change® ..... | 230-235 |
| Nano-change® .....  | 236-239 |
| Brad® Power .....   | 240-243 |

### **APPENDIX 244-273**

|  |         |
|--|---------|
| Grips Competitive Comparison Index ..... | 244-247 |
| UL / CSA Index .....                     | 248-257 |
| Alpha-Numeric Product Index .....        | 258-271 |
| Warranty .....                           | 273     |

# Got a Problem?

Woodhead provides a range of products and services to meet the most challenging problems.

## REINVENTING THE WHEEL?

Since 1922 Woodhead has solved unique product design challenges across a wide range of industries. Chances are, we already have a solution for your problem. With thousands of standard products and variations, your answer may be as simple and economical as a walk through our catalog. In fact, over 90% of our sales are from products that already exist. That's because many standard Woodhead products began as custom solutions.

## WHEN A MINOR TWEAK WILL DO

Often a simple variation of a current product will fit your application. Variations offer real-world solutions tailored to your requirements. Why waste time on the job modifying a standard product when Woodhead can create a viable ready-to-use solution? Because of their simple design demands, variations can often be a more cost-effective option than a true custom product. Typical variations include:

- Cable length
- Cable type
- Stringlight socket spacing
- Plug/connector configurations
- Wiring configurations
- Combinations of standard product
- Color

A full spectrum of colors is available to differentiate products, for example, orange was used on wiring devices for the Alaska pipeline.

TOLL FREE HOTLINE 800-354-5841 [WWW.WOODHEAD.COM](http://WWW.WOODHEAD.COM)

### A HISTORY OF SOLUTIONS

Woodhead has built its reputation by making products others can't or won't.



1920's

#### First Rubber-handled Hand Lamp

##### Railroad Industry

Designed to protect railroad workers from electrical shocks when wooden handles absorbed water exposing workers to shock hazards.



1930's

#### 600 Series Rubber-molded Watertite® Sockets

##### Railroad Industry

Twinlock friction-fit design keeps bulbs from loosening and breaking in high vibration areas. They were later used to illuminate the construction of the 1933 World's Fair Sky Ride.



1940's

#### First Rubber Multi-tap Outlet Box

##### Large Farm Equipment Mfg.

Designed of molded rubber to prevent shocks from conductive metal bases.





# Need A Solution?

From standard catalog parts to custom product solutions, we have the expertise to match.

## GOING OUTSIDE THE BOX

Despite a wide array of existing choices, some of you will be faced with an electrical challenge that cannot be addressed by any current product or variation. Ask yourself:

- What is the real problem?
- What am I trying to accomplish?
- What is the obstacle to solving the problem?

Now you're ready to explore Woodhead Custom Electrical Solutions. Custom products are recommended when standard products or variations cannot meet your job requirements.

If custom is what you need, you've come to the right place.

Throughout its history, Woodhead has ventured into uncharted territory to develop products that other manufacturers can't, or won't.

Product customization takes many forms. Woodhead offers competencies that are unrivaled in the industry. For example, owning our own rubber manufacturing plant uniquely positions us to offer specialized custom rubber capabilities. Other options include

- Custom Rubber Molding
- Non-rubber products
- Specially machined parts
- Special packaging
- Hot stamping
- Turnkey kit solutions

Military applications often demand custom design. These "specials" can then become standard catalog items with applications in industry.



What Can We Do For You?

WOODHEAD CUSTOM PRODUCTS GROUP



1960's

### First 15W Fluorescent Light

*Telecommunications Co.*

*Designed to provide brighter, cooler lighting for field maintenance crews working in confined spaces. Used the same way by helicopter maintenance crews.*



1970's

### Twin Tube Fluorescent Light

*Major Airline*

*Designed specifically for aircraft maintenance applications to provide concentrated light in tight spaces. This eliminated the need to tape two fluorescent handlamps together.*



1980's

### WaterTite® Wiring Devices

*Food Processing Co.*

*Redesigned to withstand higher water pressure from hoses in washdown environments.*



1990's

### Portable Hazardous-duty Purge Light

*Aircraft Manufacturer*

*Designed to provide safe lighting in the presence of explosive gases. New coating prescribed to reduce metal fatigue on aircraft, created noxious fumes for workers. Purge light forces explosive gases from air flow to prevent triggering an explosion.*







Whatever your lighting conditions, wherever your location, chances are Woodhead makes the portable light that best serves your needs. From fluorescent hand lamps for routine task lighting to the innovative series of HAZTEX® hazardous duty lights for wide area illumination – all over the world, in dry, wet, and hazardous locations, workers depend on the rugged, reliable performance of Woodhead lights.

All Woodhead portable lights provide the same essential benefits; each unit is built for easier handling, maintenance, transport and storage throughout an extensive operating life. That means your Woodhead portable light can save time, increase efficiency and reduce cost on the job.

Woodhead portable lights successfully balance the compactness workers need with the toughness required in specific applications. Rugged materials such as NEOTEX® rubber, molded high-impact thermoplastic and nylon, and heavy-duty zinc-plated steel are utilized to enhance durability and protect lamps, wiring and contacts against breakage, corrosion and wear. Woodhead lights are designed to be fully field-serviceable to minimize downtime and maintenance expense.

### **The Woodhead Toughness Quotient™**

This section includes a comprehensive view of the many portable lighting solutions available from Woodhead. It also features the WTQ™ (Woodhead Toughness Quotient) identifier in the upper part of the page. The WTQ is based on a performance: price ratio on a scale of 1 through 10. Products are rated according to specific criteria, including durability of materials, resistance to harsh environments, ease of use, ergonomics and safety in relation to price.

A WTQ rating of 1 – 3 indicates reliability and value for general construction projects. Woodhead products rated 4 – 6 are generally used in construction, industrial facilities, utilities, shipyards and other demanding environments. Our most rugged portable lights are assigned WTQ ratings of 7 – 10. This rating is only given to products that can withstand the severe conditions found in shipyards, steel mills, petrochemical plants, and pulp and paper facilities. Choose Woodhead and get the tough, tougher and toughest portable lighting products available for your environment.

# PORTABLE LIGHTING



## HAND LAMPS Hazardous Duty, Incandescent, 75W, 100W

Woodhead hazardous duty portable lights are designed and manufactured to meet the stringent specifications of NEC Article 500 and are U.L. listed and CSA certified for Class I, Division I, Groups C & D (flammable gases and vapors), and Class II, Division I Groups F & G (ignitable dust) as well as U.L. Class I, Zone 1, Group IIB. For hazardous duty and wet locations, use the 12-volt version of our most popular incandescent lamp with an in-line transformer or use with a low-volt workstation.

### BEST SELLERS!

#### 100W Hand Lamp

- 5-15 NEMA plug
- 75W supplied lamp
- 25' cord
- 14/3S00W secondary cord
- in-line transformer for 12V secondary voltage

part no. 1635-12A



#### 100W Hand Lamp

- 100W maximum lamp
- hand lamp only

part no. 61430



## Incandescent Hazardous Duty Hand Lamps

| PART NO.               | FIXTURE VOLTAGE | MAX. WATTAGE <sup>1</sup> | CORD TYPE | NEMA CONFIGURATION <sup>2</sup> | CORD LENGTH | MAXIMUM LAMP |
|------------------------|-----------------|---------------------------|-----------|---------------------------------|-------------|--------------|
| 61430                  | 240V MAX        | 100W                      | —         | —                               | —           | A21          |
| 61430A163 <sup>3</sup> | 240V MAX        | 100W                      | 16/3 S00W | NEMA 5-15                       | 25'         | A21          |
| 61430B163 <sup>3</sup> | 240V MAX        | 100W                      | 16/3 S00W | NEMA 5-15                       | 50'         | A21          |
| 61430D163 <sup>3</sup> | 240V MAX        | 100W                      | 16/3 S00W | NEMA 5-15                       | 100'        | A21          |

<sup>1</sup> 75W MAX. FOR CLASS II GROUP G; 100W MAX. FOR CLASS I GROUPS C & D

<sup>2</sup> ALL LAMPS FEATURE SUPER-SAFEGWAY® PLUGS

<sup>3</sup> ALSO AVAILABLE WITH #14-3 CORD: CHANGE THE LAST THREE DIGITS TO "143"; FOR EXAMPLE, 61430A163 BECOMES 61430A143

## Incandescent Hazardous Duty Hand Lamps – Low Voltage

| PART NO.             | VOLTAGE   |       | LAMP WATTAGE | MAX. WATTAGE | CORD TYPE |           | NEMA CONFIG. <sup>1</sup> | CORD LENGTH | MAX. LAMP | REPL. LAMP | TRANSFORMER TYPE |
|----------------------|-----------|-------|--------------|--------------|-----------|-----------|---------------------------|-------------|-----------|------------|------------------|
|                      | PRIM.     | SEC.  |              |              | PRIM.     | SEC.      |                           |             |           |            |                  |
| 1635-12A             | 120V/60HZ | 12VAC | 75W          | —            | 16/3 S00W | 14/3 S00W | NEMA 5-15                 | 25'         | A21       | 1652-12    | IN-LINE          |
| 1635-12B             | 120V/60HZ | 12VAC | 75W          | —            | 16/3 S00W | 14/3 S00W | NEMA 5-15                 | 50'         | A21       | 1652-12    | IN-LINE          |
| 1645-12 <sup>2</sup> | 12VAC/DC  | —     | 75W          | 100          | —         | 14/3 S00W | NON-NEMA                  | 50'         | A21       | 1652-12    | WORKSTATION      |

<sup>1</sup> ALL LAMPS FEATURE SUPER-SAFEGWAY PLUGS

<sup>2</sup> FOR USE WITH LOW VOLTAGE WORKSTATION ON PAGE 13

## Replacement Parts

| PART NO. | DESCRIPTION  |
|----------|--|
| 1676-EX  | IN-LINE TRANSFORMER COVER ASSEMBLY FOR HAZARDOUS DUTY HAND LAMPS |
| 1678-12  | IN-LINE TRANSFORMER FOR INCANDESCENT HAND LAMP                   |
| 61430RT  | REGLOBING TOOLS FOR 61430 INCANDESCENT HAND LAMP                 |
| 61431    | GUARD ASSEMBLY FOR 61430 INCANDESCENT HAND LAMP                  |
| 61432    | SOCKET AND HANDLE ASSY. FOR 61430 INCANDESCENT HAND LAMP         |
| 61435    | GLASS GLOBE FOR 61430 INCANDESCENT HAND LAMP                     |
| 61436    | HOOK ASSEMBLY FOR HAND LAMP                                      |
| 51-7272  | HOOK FOR HAND LAMPS  |



MOST WOODHEAD PRODUCTS HAVE U.L. AND/OR CSA APPROVALS. FOR A LISTING OF APPROVALS BY PART NUMBER, SEE PAGES 262-269.





**HAND LAMPS** Hazardous Duty, Fluorescent, 26W

Woodhead hazardous duty portable lights are designed and manufactured to meet the stringent specifications of NEC Article 500 and are U.L. listed and CSA certified for Class I, Division I, Groups C & D (flammable gases and vapors), and Class II, Division I Groups F & G (ignitable dust) as well as U.L. Class I, Zone 1, Group IIB. For hazardous duty and conductive locations, use the 12 volt version of our most popular fluorescent lamp with an in-line transformer or use with a low-volt workstation.

**BEST SELLERS!**

**26W Fluorescent Hand Lamp**

- 5-15 NEMA plug
- 25' 16/3 SOOW cord

part no. 1090-HZA163 (shown)

**26W Fluorescent Hand Lamp**

- same as above, hand lamp only

part no. 1090-HZ



**Fluorescent Hazardous Duty Hand Lamps**

| PART NO.                 | FIXTURE VOLTAGE |       | LAMP WATT. | CORD TYPE | NEMA CONFIG. <sup>1</sup> | CORD LENGTH | LUMENS | LAMP TYPE     | REPL. LAMP | TRANSFORMER TYPE |
|--------------------------|-----------------|-------|------------|-----------|---------------------------|-------------|--------|---------------|------------|------------------|
|                          | PRIM.           | SEC.  |            |           |                           |             |        |               |            |                  |
| 1090-HZ                  | 120V/60HZ       | —     | 26W        | —         | —                         | —           | 1800   | PL-C 26/41/4P | 34-0391    | N/A              |
| 1090-HZA163 <sup>2</sup> | 120V/60HZ       | —     | 26W        | 16/3 SOOW | NEMA 5-15                 | 25'         | 1800   | PL-C 26/41/4P | 34-0391    | N/A              |
| 1090-HZB163 <sup>2</sup> | 120V/60HZ       | —     | 26W        | 16/3 SOOW | NEMA 5-15                 | 50'         | 1800   | PL-C 26/41/4P | 34-0391    | N/A              |
| 1090-HZD163 <sup>2</sup> | 120V/60HZ       | —     | 26W        | 16/3 SOOW | NEMA 5-15                 | 100'        | 1800   | PL-C 26/41/4P | 34-0391    | N/A              |
| 1090-HZ12IA163           | 120V/60HZ       | 12VAC | 26W        | 16/3 SOOW | NEMA 5-15                 | 25'         | 1800   | PL-C 26/41/4P | 34-0391    | IN-LINE          |
| 1090-HZ12IB163           | 120V/60HZ       | 12VAC | 26W        | 16/3 SOOW | NEMA 5-15                 | 50'         | 1800   | PL-C 26/41/4P | 34-0391    | IN-LINE          |
| 1090-HZ12ID143           | 120V/60HZ       | 12VAC | 26W        | 14/3 SOOW | NEMA 5-15                 | 100'        | 1800   | PL-C 26/41/4P | 34-0391    | IN-LINE          |
| 1090-HZ12IB163P          | 220/12          | —     | 26W        | 16/3 SOOW | —                         | 50'         | 1800   | PL-C 26/41/4P | 34-0391    | IN-LINE          |
| 1090-HZ12ID143P          | 220/12          | —     | 26W        | 14/3 SOOW | —                         | 50'         | 1800   | PL-C 26/41/4P | 34-0391    | IN-LINE          |

<sup>1</sup> ALL LAMPS FEATURE SUPER-SAFEWAY® PLUGS

<sup>2</sup> ALSO AVAILABLE WITH #14-3 CORD: CHANGE THE LAST THREE DIGITS TO "143"; FOR EXAMPLE, 61430A163 BECOMES 61430A143

**Fluorescent Hazardous Duty Hand Lamps – Low Voltage**

| PART NO.                   | FIXTURE VOLTAGE |      | LAMP WATT. | CORD TYPE | NEMA CONFIG. <sup>1</sup> | CORD LENGTH | LUMENS | LAMP TYPE     | REPL. LAMP | TRANSFORMER TYPE |
|----------------------------|-----------------|------|------------|-----------|---------------------------|-------------|--------|---------------|------------|------------------|
|                            | PRIM.           | SEC. |            |           |                           |             |        |               |            |                  |
| 1090-HZ12A163 <sup>2</sup> | 12VAC           | —    | 26W        | 16/3 SOOW | NON-NEMA                  | 25'         | 1800   | PL-C 26/41/4P | 34-0391    | WORKSTATION      |
| 1090-HZ12B163 <sup>2</sup> | 12VAC           | —    | 26W        | 16/3 SOOW | NON-NEMA                  | 50'         | 1800   | PL-C 26/41/4P | 34-0391    | WORKSTATION      |

<sup>1</sup> ALL LAMPS FEATURE SUPER-SAFEWAY PLUGS

<sup>2</sup> FOR USE WITH LOW VOLTAGE WORKSTATION ON PAGE 13

**Replacement Parts**

| PART NO. | DESCRIPTION   | PART NO. | DESCRIPTION     |
|----------|---------------|----------|-----------------|
| 00-1470  | CAP BUMPER    | 40-9441  | LAMP GUARD      |
| 00-1480  | GUARD BUMPER  | 40-9451  | END CAP         |
| 00-1490  | HANDLE BUMPER | 40-9456  | HANDLE ASSEMBLY |
| 40-9442  | GLASS GLOBE   |          |                 |



MOST WOODHEAD PRODUCTS HAVE U.L. AND/OR CSA APPROVALS. FOR A LISTING OF APPROVALS BY PART NUMBER, SEE PAGES 262-269.

## HAND LAMPS Wet Location, Incandescent, 100W

Woodhead offers an extensive line of wet location lighting solutions that meet and exceed the OSHA requirements for wet location use. U.L. listed NEMA 4X for damp locations, these Watertite® incandescent hand lamps are the tough industrial tools you can rely on for the desired level of illumination and protection needed in wet work areas.



### BEST SELLERS!

#### Hand Lamp

- 5-15 NEMA plug
- 25' 16/3 S00W cord
- grounded guard

part no. 1203A163 (shown)

#### Hand Lamp

- 5-15 NEMA plug
- guard with reflector and ground clip
- no cord

part no. 1203RGC

## Incandescent Hand Lamps for Wet Locations

Tempered glass globe. For replacement parts, see page 21.

| PART NO.    | FIXTURE VOLTAGE | GROUNDING GUARD | QUICK OPEN GUARD | GUARD WITH REFLECTOR | RUBBER COATED GUARD | POLY CARB GLOBE | CORD TYPE | NEMA CONFIGURATION | CORD LENGTH | LAMP TYPE |
|-------------|-----------------|-----------------|------------------|----------------------|---------------------|-----------------|-----------|--------------------|-------------|-----------|
| 1203        | 120VAC          |                 |                  |                      |                     |                 | —         | —                  | —           | A21       |
| 1203A163    | 120VAC          | ●               |                  |                      |                     |                 | 16/3 S00W | NEMA 5-15          | 25'         | A21       |
| 1203B163    | 120VAC          | ●               |                  |                      |                     |                 | 16/3 S00W | NEMA 5-15          | 50'         | A21       |
| 1203GC      | 120VAC          | ●               |                  |                      |                     |                 | —         | —                  | —           | A21       |
| 1203P       | 120VAC          |                 |                  |                      |                     | ●               | —         | —                  | —           | A21       |
| 1203Q0      | 120VAC          |                 | ●                |                      |                     |                 | —         | —                  | —           | A21       |
| 1203Q0A163  | 120VAC          | ●               | ●                |                      |                     |                 | 16/3 S00W | NEMA 5-15          | 25'         | A21       |
| 1203Q0B163  | 120VAC          | ●               | ●                |                      |                     |                 | 16/3 S00W | NEMA 5-15          | 50'         | A21       |
| 1203Q0GC    | 120VAC          | ●               | ●                |                      |                     |                 | —         | —                  | —           | A21       |
| 1203PQ0A163 | 120VAC          | ●               | ●                |                      |                     | ●               | 16/3 S00W | NEMA 5-15          | 25'         | A21       |
| 1203PQ0B143 | 120VAC          | ●               | ●                |                      |                     | ●               | 14/3 S00W | NEMA 5-15          | 50'         | A21       |
| 1203R       | 120VAC          |                 |                  | ●                    |                     |                 | —         | —                  | —           | A21       |
| 1203RA163   | 120VAC          | ●               |                  | ●                    |                     |                 | 16/3 S00W | NEMA 5-15          | 25'         | A21       |
| 1203RB163   | 120VAC          | ●               |                  | ●                    |                     |                 | 16/3 S00W | NEMA 5-15          | 50'         | A21       |
| 1203RGC     | 120VAC          | ●               |                  | ●                    |                     |                 | —         | —                  | —           | A21       |
| 1203RI      | 120VAC          |                 |                  | ●                    | ●                   |                 | —         | —                  | —           | A21       |
| 1203RIA163  | 120VAC          | ●               |                  | ●                    | ●                   |                 | 16/3 S00W | NEMA 5-15          | 25'         | A21       |
| 1203RIB163  | 120VAC          | ●               |                  | ●                    | ●                   |                 | 16/3 S00W | NEMA 5-15          | 50'         | A21       |
| 1203RIGC    | 120VAC          | ●               |                  | ●                    | ●                   |                 | —         | —                  | —           | A21       |

MOST WOODHEAD PRODUCTS HAVE U.L. AND/OR CSA APPROVALS. FOR A LISTING OF APPROVALS BY PART NUMBER, SEE PAGES 262-269.





HAND LAMPS Wet Location, Incandescent, 75W, 100W



- Hand Lamp**
- 5-15 NEMA plug
  - 25' 16/2 S00W cord
  - Teflon® globe
  - 75 watt A21 Max

part no. 1223



**BEST SELLERS!**

- Hand Lamp**
- 5-15 NEMA plug
  - 25' 16/3 S00W cord
  - rubber coated guard

part no. 1203IA163

**Incandescent Hand Lamps for Wet Locations** Tempered glass globe. For replacement parts, see page 21.

| PART NO.   | FIXTURE VOLTAGE | GROUNDING GUARD | CAST ALUMINUM GUARD | GUARD WITH REFLECTOR | RUBBER COATED GUARD | POLY CARB GLOBE | CORD TYPE | NEMA CONFIGURATION | CORD LENGTH | LAMP TYPE |
|------------|-----------------|-----------------|---------------------|----------------------|---------------------|-----------------|-----------|--------------------|-------------|-----------|
| 1203PRI    | 120VAC          |                 |                     | ●                    | ●                   | ●               | —         | —                  | —           | A21       |
| 1203RA163P | 120VAC          | ●               |                     | ●                    |                     | ●               | 16/3 S00W | NEMA 5-15          | 25'         | A21       |
| 1203RB163P | 120VAC          | ●               |                     | ●                    |                     | ●               | 16/3 S00W | NEMA 5-15          | 50'         | A21       |
| 1203I      | 120VAC          |                 |                     |                      | ●                   |                 | —         | —                  | —           | A21       |
| 1203IA163  | 120VAC          | ●               |                     |                      | ●                   |                 | 16/3 S00W | NEMA 5-15          | 25'         | A21       |
| 1203IB163  | 120VAC          | ●               |                     |                      | ●                   |                 | 16/3 S00W | NEMA 5-15          | 50'         | A21       |
| 1203IGC    | 120VAC          | ●               |                     |                      | ●                   |                 | —         | —                  | —           | A21       |
| 1207       | 120VAC          |                 | ●                   |                      |                     |                 | —         | —                  | —           | A21       |
| 1207A163   | 120VAC          | ●               | ●                   |                      |                     |                 | 16/3 S00W | NEMA 5-15          | 25'         | A21       |
| 1207B163   | 120VAC          | ●               | ●                   |                      |                     |                 | 16/3 S00W | NEMA 5-15          | 50'         | A21       |
| 1207GC     | 120VAC          | ●               | ●                   |                      |                     |                 | —         | —                  | —           | A21       |
| 1207R      | 120VAC          |                 | ●                   | ●                    |                     |                 | —         | —                  | —           | A21       |
| 1207RA163  | 120VAC          | ●               | ●                   | ●                    |                     |                 | 16/3 S00W | NEMA 5-15          | 25'         | A21       |
| 1207RB163  | 120VAC          | ●               | ●                   | ●                    |                     |                 | 16/3 S00W | NEMA 5-15          | 50'         | A21       |
| 1207RGC    | 120VAC          | ●               | ●                   | ●                    |                     |                 | —         | —                  | —           | A21       |
| 1207P      | 120VAC          |                 | ●                   |                      |                     | ●               | —         | —                  | —           | A21       |
| 1207PRB163 | 120VAC          | ●               | ●                   | ●                    |                     | ●               | 16/3 S00W | NEMA 5-15          | 50'         | A21       |
| 1220'      | 120VAC          |                 |                     |                      |                     |                 | —         | —                  | —           | A21       |
| 1223'      | 120VAC          |                 |                     |                      |                     |                 | 16/2 S00W | NEMA 1-15          | 25'         | A21       |
| 1225'      | 120VAC          |                 |                     |                      |                     |                 | 16/2 S00W | NEMA 1-15          | 50'         | A21       |

<sup>1</sup> INCLUDES TEFLON® GLOBE





## HAND LAMPS Wet Location, Low Voltage, Incandescent, 75W

Woodhead offers an extensive line of wet location lighting solutions that meet and exceed the OSHA requirements for wet location use. U.L. listed NEMA 4X for damp locations, these Watertite® incandescent hand lamps are the tough industrial tools you can rely on for the desired level of illumination and protection needed in wet work areas.

### BEST SELLER!

#### Low Voltage Hand Lamp

- 5-15 NEMA plug
- in-line transformer
- 120V/60HZ primary fixture voltage

part no. 1621-12A (shown)

#### Low Voltage Hand Lamp

- 100W max. lamp
- 12VAC/DC primary fixture voltage
- for use with low voltage workstation (p. 13)

part no. 1649-12



## Incandescent Hand Lamps – Low Voltage

Tempered glass globe. All lamps are supplied with 12V, 75W, A21 bulbs and have 10 ft. of primary cord length before transformer.

| PART NO.             | FIXTURE VOLTAGE |       | GUARD TYPE WITH SCREW RELEASE |            |        | CORD TYPE |           | NEMA CONFIG. | CORD LENGTH | RPLC. LAMP | TRANSFORMER TYPE |
|----------------------|-----------------|-------|-------------------------------|------------|--------|-----------|-----------|--------------|-------------|------------|------------------|
|                      | PRIM            | SEC.  | STEEL                         | CAST ALUM. | TEFLON | PRIMARY   | SECONDARY |              |             |            |                  |
| 1621-12B             | 120V/60HZ       | 12VAC | ●                             |            |        | 16/3 SOOW | 14/2 SOOW | NEMA 5-15    | 50'         | 1652-12    | IN-LINE          |
| 1625-12B             | 120V/60HZ       | 12VAC |                               |            | ●      | 16/3 SOOW | 14/2 SOOW | NEMA 5-15    | 50'         | 1652-12    | IN-LINE          |
| 1631-12B             | 120V/60HZ       | 12VAC |                               | ●          |        | 16/3 SOOW | 14/2 SOOW | NEMA 5-15    | 50'         | 1652-12    | IN-LINE          |
| 1621-12A             | 120V/60HZ       | 12VAC | ●                             |            |        | 16/3 SOOW | 14/2 SOOW | NEMA 5-15    | 25'         | 1652-12    | IN-LINE          |
| 1649-12 <sup>1</sup> | 12VAC/DC        | —     | ●                             |            |        | 14/2 SOOW | —         | NON-NEMA     | 50'         | 1652-12    | WORKSTATION      |
| 1621-12B-P           | 220V/50HZ       | 12VAC | ●                             |            |        | 16/3 SOOW | 14/2 SOOW | —            | 50'         | 1652-12    | IN-LINE          |
| 1625-12A             | 120V/60HZ       | 12VAC |                               |            | ●      | 16/3 SOOW | 14/2 SOOW | NEMA 5-15    | 25'         | 1652-12    | IN-LINE          |
| 1631-12A             | 120V/60HZ       | 12VAC |                               | ●          |        | 16/3 SOOW | 14/2 SOOW | NEMA 5-15    | 25'         | 1652-12    | IN-LINE          |
| 1646-12 <sup>1</sup> | 12VAC/DC        | —     |                               |            | ●      | 14/2 SOOW | —         | NON-NEMA     | 50'         | 1652-12    | WORKSTATION      |

<sup>1</sup> FOR USE WITH LOW VOLTAGE WORKSTATION ON PAGE 13



MOST WOODHEAD PRODUCTS HAVE U.L. AND/OR CSA APPROVALS.  
FOR A LISTING OF APPROVALS BY PART NUMBER, SEE PAGES 262-269.

## GUARDS Wet Location, Incandescent, Hand Lamps



1255



1255R



1259

**Guards** For use with Watertite® incandescent hand lamps.

| PART NO. | DESCRIPTION                  | LAMP TYPE |
|----------|------------------------------|-----------|
| 1255     | —                            | A21       |
| 1255R    | WITH REFLECTOR               | A21       |
| 1259     | QUICK OPEN                   | A21       |
| 1257     | CAST ALUMINUM                | A21       |
| 1255IG   | RUBBER COATED                | A21       |
| 1255RIG  | RUBBER COATED WITH REFLECTOR | A21       |
| 1257R    | CAST ALUMINUM WITH REFLECTOR | A21       |
| 1259R    | QUICK OPEN WITH REFLECTOR    | A21       |

### Replacement Parts and Lamps

| PART NO. | DESCRIPTION   |
|----------|---|
| 1229     | TEFLON® GLOBE FOR WATERTITE® INCANDESCENT HAND LAMP           |
| 1253     | GLASS GLOBE FOR WATERTITE® INCANDESCENT HAND LAMP             |
| 1261     | HANDLE FOR WATERTITE® INCANDESCENT HAND LAMP                  |
| 1261GC   | HANDLE FOR WATERTITE® INCANDESCENT HAND LAMP WITH GROUND CLIP |

| PART NO. | DESCRIPTION   |
|----------|---|
| 1278     | GROUND CLIP FOR WATERTITE® INCANDESCENT HAND LAMP         |
| 41-6762  | POLYCARBONATE GLOBE FOR WATERTITE® INCANDESCENT HAND LAMP |
| 70-3000  | RETAINING RING FOR TEFLON® GLOBE                          |



MOST WOODHEAD PRODUCTS HAVE U.L. AND/OR CSA APPROVALS.  
FOR A LISTING OF APPROVALS BY PART NUMBER, SEE PAGES 262-269.





## HAND LAMPS Industrial Duty, Incandescent, 100W

Heavy-duty construction and long operating life in industrial applications sets the Woodhead line of incandescent hand lamps apart from all others. #8 gauge zinc-plated guards and thick NEOTEX® rubber handles protect bulbs and electrical components, while an ergonomically designed fencer's flange handle helps protect the user from accidentally touching a hot steel guard. The use of in-line transformers step voltage levels down to 12V for added safety.

### BEST SELLERS!

#### Incandescent Hand Lamp with In-Line Transformer

- 5-15 NEMA plug
- 25' 16/3 SOOW cord
- reflector in guard

part no. 1601-12A (shown)

#### Incandescent Hand Lamp with In-Line Transformer

- 5-15 NEMA plug
- 25' 16/3 SOOW cord
- No reflector in guard

part no. 1600-12A



## Incandescent Low Voltage Hand Lamps with In-Line Transformer

All lamps are supplied with 75W bulbs and have 10 ft. of primary cord length before transformer.

| PART NO.             | FIXTURE VOLTAGE |        | MAX. LAMP WATTAGE | CORD TYPE |           | NEMA CONFIGURATION <sup>1</sup> | CORD LENGTH | LAMP TYPE | REPL. LAMP | TRANSFORMER TYPE |
|----------------------|-----------------|--------|-------------------|-----------|-----------|---------------------------------|-------------|-----------|------------|------------------|
|                      | PRIM.           | SEC.   |                   | PRIMARY   | SECONDARY |                                 |             |           |            |                  |
| 1601-12A             | 120V/60HZ       | 12VAC  | 75W               | 16/3 SOOW | 14/2 SOOW | NEMA 5-15                       | 25'         | A21       | 1652-12    | IN-LINE          |
| 1601-12B             | 120V/60HZ       | 12V AC | 75W               | 16/3 SOOW | 14/2 SOOW | NEMA 5-15                       | 50'         | A21       | 1652-12    | IN-LINE          |
| 1600-12A             | 120V/60HZ       | 12VAC  | 75W               | 16/3 SOOW | 14/2 SOOW | NEMA 5-15                       | 25'         | A21       | 1652-12    | IN-LINE          |
| 1600-12B             | 120V/60HZ       | 12VAC  | 75W               | 16/3 SOOW | 14/2 SOOW | NEMA 5-15                       | 50'         | A21       | 1652-12    | IN-LINE          |
| 1648-12 <sup>2</sup> | —               | 12VAC  | 75W               | —         | 14/2 SOOW | NON-NEMA                        | 50'         | A21       | 1652-12    | WORKSTATION      |

<sup>1</sup> ALL LAMPS FEATURE SUPER-SAFEWAY® PLUGS

<sup>2</sup> FOR USE WITH LOW VOLTAGE WORKSTATION ON PAGE 13



MOST WOODHEAD PRODUCTS HAVE U.L. AND/OR CSA APPROVALS. FOR A LISTING OF APPROVALS BY PART NUMBER, SEE PAGES 262-269.



LOW VOLTAGE WORKSTATION

Woodhead step-down transformers convert 120V power to 12V power for use in wet locations with 12V tools and lights. Low-voltage workstations are exceptionally durable, easy to handle and service and capable of long continuous operation in some of industry's most demanding environments. To protect workers and comply with OSHA, the transformers must be kept out of the wet location as 120V primary voltage should not be located in such areas. Circuit breakers located on the low voltage workstation provide 15 amp protection.

**BEST SELLERS!**

**4 Outlet Workstation**

- Non-NEMA crowfoot receptacles
- 400W maximum

part no. 1640-12 (shown)

**2 Outlet Workstation**

- Non-NEMA crowfoot receptacles
- 200W maximum

part no. 1642-12



Low Voltage Workstation

| PART NO.             | FIXTURE VOLTAGE |       | MAX. LAMP WATT. | OUTLETS                   | CORD TYPE | NEMA CONFIGURATION | CORD LENGTH |
|----------------------|-----------------|-------|-----------------|---------------------------|-----------|--------------------|-------------|
|                      | PRIM.           | SEC.  |                 |                           |           |                    |             |
| 1640-12              | 120V/60HZ       | 12VAC | 400W            | 4 60W07 NON-NEMA CROWFOOT | 16/3 SOOW | NEMA 5-15          | 6'          |
| 1642-12              | 120V/60HZ       | 12VAC | 200W            | 2 60W07 NON-NEMA CROWFOOT | 16/3 SOOW | NEMA 5-15          | 6'          |
| 1641-12 <sup>2</sup> | 120V/60HZ       | 12VAC | 400W            | 1 69W08 NON-NEMA LOCKING  | 16/3 SOOW | NEMA 5-15          | 10'         |
| 1644-12 <sup>1</sup> | 120V/60HZ       | 12VAC | 200W            | 2 60W07 NON-NEMA CROWFOOT | 16/3 SOOW | NEMA 5-15          | 6'          |
| 1643-12 <sup>1</sup> | 120V/60HZ       | 12VAC | 400W            | 4 60W07 NON-NEMA CROWFOOT | 16/3 SOOW | NEMA 5-15          | 6'          |

<sup>1</sup> FOR USE WITH NO. 8500 HALOGEN WIDE AREA LIGHT, 10 AMP CIRCUIT BREAKER PROTECTION

<sup>2</sup> FOR USE WITH NO. 321637 STRINGLIGHT, 30 AMP CIRCUIT BREAKER PROTECTION

MOST WOODHEAD PRODUCTS HAVE U.L. AND/OR CSA APPROVALS. FOR A LISTING OF APPROVALS BY PART NUMBER, SEE PAGES 262-269.



## HAND LAMPS Industrial Duty, Incandescent, 100W

Heavy-duty construction and long operating life in industrial applications is what sets the Woodhead line of incandescent hand lamps apart from all others. #8 gauge zinc-plated guards and thick NEOTEX® rubber handles help protect bulbs and electrical components, while an ergonomically designed fencer's flange handle helps protect the user from accidentally touching a hot steel guard.



### BEST SELLERS!

#### Incandescent Hand Lamp

- on/off switch in handle
- utility outlet in handle
- screw release guard with reflector
- 25' 16/3 SOOW cord

part no. 106USA163



#### Incandescent Hand Lamp

- on/off switch in handle
- utility outlet in handle
- quick-open guard with reflector
- handle and guard only

part no. 105US

## Incandescent Hand Lamps

| PART NO.  | SIDE OUTLET | SWITCH | GUARD TYPE WITH REFLECTOR |               | FIXTURE VOLTAGE | MAX. LAMP WATT. | CORD TYPE | CORD LENGTH |
|-----------|-------------|--------|---------------------------|---------------|-----------------|-----------------|-----------|-------------|
|           |             |        | QUICK-OPEN                | SCREW RELEASE |                 |                 |           |             |
| 105US     | ●           | ●      | ●                         |               | 240V MAX        | 100W            | —         | —           |
| 105USA163 | ●           | ●      | ●                         |               | 240V MAX        | 100W            | 16/3 SOOW | 25'         |
| 105USB163 | ●           | ●      | ●                         |               | 240V MAX        | 100W            | 16/3 SOOW | 50'         |
| 105S      |             | ●      | ●                         |               | 240V MAX        | 100W            | —         | —           |
| 105SA163  |             | ●      | ●                         |               | 240V MAX        | 100W            | 16/3 SOOW | 25'         |
| 105SB163  |             | ●      | ●                         |               | 240V MAX        | 100W            | 16/3 SOOW | 50'         |
| 105U      | ●           |        | ●                         |               | 240V MAX        | 100W            | —         | —           |
| 105UA163  | ●           |        | ●                         |               | 240V MAX        | 100W            | 16/3 SOOW | 25'         |
| 105UB163  | ●           |        | ●                         |               | 240V MAX        | 100W            | 16/3 SOOW | 50'         |
| 105       |             |        | ●                         |               | 240V MAX        | 100W            | —         | —           |
| 105A163   |             |        | ●                         |               | 240V MAX        | 100W            | 16/3 SOOW | 25'         |
| 105B163   |             |        | ●                         |               | 240V MAX        | 100W            | 16/3 SOOW | 50'         |
| 106US     | ●           | ●      |                           | ●             | 240V MAX        | 100W            | —         | —           |
| 106USA163 | ●           | ●      |                           | ●             | 240V MAX        | 100W            | 16/3 SOOW | 25'         |
| 106USB163 | ●           | ●      |                           | ●             | 240V MAX        | 100W            | 16/3 SOOW | 50'         |
| 106S      |             | ●      |                           | ●             | 240V MAX        | 100W            | —         | —           |
| 106SA163  |             | ●      |                           | ●             | 240V MAX        | 100W            | 16/3 SOOW | 25'         |
| 106SB163  |             | ●      |                           | ●             | 240V MAX        | 100W            | 16/3 SOOW | 50'         |
| 106U      | ●           |        |                           | ●             | 240V MAX        | 100W            | —         | —           |
| 106UA163  | ●           |        |                           | ●             | 240V MAX        | 100W            | 16/3 SOOW | 25'         |
| 106UB163  | ●           |        |                           | ●             | 240V MAX        | 100W            | 16/3 SOOW | 50'         |
| 106       |             |        |                           | ●             | 240V MAX        | 100W            | —         | —           |
| 106A163   |             |        |                           | ●             | 240V MAX        | 100W            | 16/3 SOOW | 25'         |
| 106B163   |             |        |                           | ●             | 240V MAX        | 100W            | 16/3 SOOW | 50'         |



MOST WOODHEAD PRODUCTS HAVE U.L. AND/OR CSA APPROVALS. FOR A LISTING OF APPROVALS BY PART NUMBER, SEE PAGES 262-269.





## HAND LAMPS Industrial Duty, Incandescent, 75W-300W

### BUILD A HAND LAMP

To customize your Woodhead hand lamp, first select a handle assembly from the chart below, then choose the best guard for your application.



### STEP 1 Select a Handle

|                    | HANDLE ONLY | SWITCH  | OUTLET  | OUTLET/SWITCH |
|--------------------|-------------|---------|---------|---------------|
|                    |             |         |         |               |
| <b>NO CORD</b>     | 1173        | 1174    | 1175U   | 1175US        |
| <b>25 FT. CORD</b> | 41-7370     | 41-7390 | 41-7410 | 41-7430       |
| <b>50 FT. CORD</b> | 41-7380     | 41-7400 | 41-7420 | 41-7440       |

### STEP 2 Select a Guard

| GUARD TYPE                     | CLOSED                   | CLOSED                   | CLOSED                      | CLOSED                      | CLOSED                      | CLOSED                      |
|--------------------------------|--------------------------|--------------------------|-----------------------------|-----------------------------|-----------------------------|-----------------------------|
| ACCESSIBILITY                  | SCREW RELEASE            | SCREW RELEASE            | QUICK OPEN                  | QUICK OPEN                  | SCREW RELEASE               | SCREW RELEASE               |
| REFLECTOR                      |                          | ●                        |                             | ●                           |                             | ●                           |
| LAMP TYPE(S)                   | 75-100W<br>A19, A21, A23 | 75-100W<br>A19, A21, A23 | 75-100W<br>A19, A21, A23    | 75-100W<br>A19, A21, A23    | 200-300W<br>A21, PS30, PS25 | 200-300W<br>A21, PS30, PS25 |
|                                |                          |                          |                             |                             |                             |                             |
| <b>ZINC PLATED STEEL</b>       | 1152                     | 1156                     | 1162                        | 1166                        | 1153                        | 1157                        |
| <b>RUBBER COATED INSULATED</b> | 1152IG                   | 1156IG                   | 1162IG                      | —                           | 1153IG                      | 1157IG                      |
| GUARD TYPE                     | OPEN                     | OPEN                     | OPEN                        | OPEN                        | CLOSED NYLON                | OPEN                        |
| ACCESSIBILITY                  | SCREW RELEASE            | SCREW RELEASE            | SCREW RELEASE               | SCREW RELEASE               | QUICK OPEN                  | SCREW RELEASE               |
| REFLECTOR                      |                          | ●                        |                             | ●                           | ●                           |                             |
| LAMP TYPE(S)                   | 75-100W<br>A19, A21, A23 | 75-100W<br>A19, A21, A23 | 200-300W<br>A21, PS30, PS25 | 200-300W<br>A21, PS30, PS25 | 75-100W<br>A19, A21, A23    | PAR 38                      |
|                                |                          |                          |                             |                             |                             |                             |
| <b>ZINC PLATED STEEL</b>       | 1160                     | 1164                     | 1161                        | 1165                        | 1168                        | 1181                        |
| <b>RUBBER COATED INSULATED</b> | 1160IG                   | 1164IG                   | 1161IG                      | 1165IG                      | —                           | —                           |

### Replacement Parts

| PART NO. | DESCRIPTION   |
|----------|---|
| 1133     | SOCKET ASSEMBLY FOR SUPER SAFEWAY® INCANDESCENT HAND LAMP                   |
| 1134     | SOCKET ASSEMBLY FOR SUPER SAFEWAY INCANDESCENT HAND LAMP/SWITCH             |
| 1135U    | SOCKET ASSEMBLY FOR SUPER SAFEWAY INCANDESCENT HAND LAMP/SIDE OUTLET        |
| 1135US   | SOCKET ASSEMBLY FOR SUPER SAFEWAY INCANDESCENT HAND LAMP/SIDE OUTLET/SWITCH |
| 1143     | RUBBER HANDLE FOR SUPER SAFEWAY INCANDESCENT HAND LAMP                      |
| 1144     | RUBBER HANDLE FOR SUPER SAFEWAY INCANDESCENT HAND LAMP/SWITCH               |
| 1145U    | RUBBER HANDLE FOR SUPER SAFEWAY INCANDESCENT HAND LAMP/SIDE OUTLET          |
| 1145US   | RUBBER HANDLE FOR SUPER SAFEWAY INCANDESCENT HAND LAMP/SIDE OUTLET/SWITCH   |



MOST WOODHEAD PRODUCTS HAVE U.L. AND/OR CSA APPROVALS.  
FOR A LISTING OF APPROVALS BY PART NUMBER, SEE PAGES 262-269.

# PORTABLE LIGHTING



## HAND LAMPS Industrial Duty, Fluorescent, 13W, 27W, 40W

Ideal for task lighting applications, fluorescent hand lamps offer bright, diffuse illumination from 900 to 3150 lumens and still remain cool to the touch. The fluorescent bulbs and rubber handles offer the robust and rugged features that provide you with the safety, durability and reliability you expect from a Woodhead hand lamp.

### BEST SELLERS!

#### 13W Hand Lamp

- on/off switch in handle
- ballast on cord
- lamp type PL13/41
- 25' 18/3 SJT00W cord

part no. 1083-3



#### 13W Hand Lamp

- same as 1083-3 except ballast in handle and 16/3 SJT0W cord type

part no. 1086-3



#### 27W Hand Lamp

- on/off switch in handle
- ballast on cord
- lamp type PL27/41
- 25' 18/3 SJT00W cord

part no. 1093-3



#### 40W Hand Lamp

- on/off switch in handle
- ballast on cord
- lamp type PL40/41
- 25' 18/3 SJT00W cord

part no. 1097-3



MOST WOODHEAD PRODUCTS HAVE U.L. AND/OR CSA APPROVALS. FOR A LISTING OF APPROVALS BY PART NUMBER, SEE PAGES 262-269.

## Fluorescent Hand Lamps

| PART NO. | SWITCH | FIXTURE VOLTAGE | LAMP WATTAGE | CORD TYPE   | BALLAST LOCATION | NEMA CONFIGURATION | CORD LENGTH | LUMENS | LAMP TYPE  | REPL. LAMP |
|----------|--------|-----------------|--------------|-------------|------------------|--------------------|-------------|--------|------------|------------|
| 1083-3   | ●      | 120V/60HZ       | 13W          | 18/3 SJT00W | CORD             | NEMA 5-15          | 25'         | 900    | PL13/41    | 34-0390    |
| 1083-3NS |        | 120V/60HZ       | 13W          | 18/3 SJT00W | CORD             | NEMA 5-15          | 25'         | 900    | PL13/41    | 34-0390    |
| 1085-3NS |        | 120V/60HZ       | 13W          | 18/3 SJT00W | CORD             | NEMA 5-15          | 50'         | 900    | PL13/41    | 34-0390    |
| 1086-3NS |        | 120V/60HZ       | 13W          | 16/3 SJT0W  | HANDLE           | NEMA 5-15          | 25'         | 900    | PL13/41    | 34-0390    |
| 1087-3NS |        | 120V/60HZ       | 13W          | 16/3 SJT0W  | HANDLE           | NEMA 5-15          | 50'         | 900    | PL13/41    | 34-0390    |
| 1085-3   | ●      | 120V/60HZ       | 13W          | 18/3 SJT00W | CORD             | NEMA 5-15          | 50'         | 900    | PL13/41    | 34-0390    |
| 1086-3   | ●      | 120V/60HZ       | 13W          | 16/3 SJT0W  | HANDLE           | NEMA 5-15          | 25'         | 900    | PL13/41    | 34-0390    |
| 1087-3   | ●      | 120V/60HZ       | 13W          | 16/3 SJT0W  | HANDLE           | NEMA 5-15          | 50'         | 900    | PL13/41    | 34-0390    |
| 1093-3   | ●      | 120V/60HZ       | 27W          | 18/3 SJT00W | CORD             | NEMA 5-15          | 25'         | 1800   | PL-L 27/41 | 34-0130    |
| 1095-3   | ●      | 120V/60HZ       | 27W          | 18/3 SJT00W | CORD             | NEMA 5-15          | 50'         | 1800   | PL-L 27/41 | 34-0130    |
| 1097-3   | ●      | 120V/60HZ       | 40W          | 18/3 SJT00W | CORD             | NEMA 5-15          | 25'         | 3150   | PL-L 40/41 | 34-0120    |
| 1099-3   | ●      | 120V/60HZ       | 40W          | 18/3 SJT00W | CORD             | NEMA 5-15          | 50'         | 3150   | PL-L 40/41 | 34-0120    |
| 1083-3-P | ●      | 230V/50HZ       | 13W          | 18/3 SJT00W | CORD             | —                  | 25'         | 900    | PL13/41    | 34-0390    |
| 1085-3-P | ●      | 230V/50HZ       | 13W          | 18/3 SJT00W | CORD             | —                  | 50'         | 900    | PL13/41    | 34-0390    |
| 1083-3-E | ●      | 110V/50HZ       | 13W          | 18/3 SJT00W | CORD             | —                  | 25'         | 900    | PL13/41    | 34-0390    |
| 1086-3-E | ●      | 110V/50HZ       | 13W          | 16/3 SJT0W  | HANDLE           | —                  | 25'         | 900    | PL13/41    | 34-0390    |
| 1087-3-E | ●      | 110V/50HZ       | 13W          | 16/3 SJT0W  | HANDLE           | —                  | 50'         | 900    | PL13/41    | 34-0390    |
| 1093-3-E | ●      | 110V/50HZ       | 27W          | 18/3 SJT00W | CORD             | —                  | 25'         | 1800   | PL-L 27/41 | 34-0130    |
| 1097-3-E | ●      | 110V/50HZ       | 40W          | 18/3 SJT00W | CORD             | —                  | 25'         | 3150   | PL-L 40/41 | 34-0120    |
| 1099-3-E | ●      | 110V/50HZ       | 40W          | 18/3 SJT00W | CORD             | —                  | 25'         | 3150   | PL-L 40/41 | 34-0120    |

## Replacement Parts

| PART NO.   | DESCRIPTION  |
|------------|--|
| 1086LC     | TEAR OFF SHIELD COVER FOR 1083-3 & 1086-3 HAND LAMPS   |
| 1083-3HON  | 1083-3 WITHOUT CORD; FIXTURE ONLY  |
| 1083-3HONS | 1083-3 WITHOUT CORD AND SWITCH; FIXTURE ONLY   |
| 1086-3HO   | 13W. WITH SWITCH & BALLAST IN HANDLE 120V/60HZ FIX. VOLT., 900 LUMENS, LAMP TYPE PL13/41, 34-0390 REPLAC. LAMP |
| 34-0390    | 13W PL LAMP  |

| PART NO. | DESCRIPTION  |
|----------|--|
| 34-0130  | 27W PL-L LAMP  |
| 40-1040  | SHIELD ASSY. FOR 13W FLUOR. HAND LAMP (1083/1086 SERIES) |
| 40-1020  | SHIELD ASSEMBLY FOR 27W HAND LAMP (1093 SERIES)          |
| 40-1021  | SHIELD ASSEMBLY FOR 40W HAND LAMP (1097 SERIES)          |
| 70-1350  | NYLON HOOK FOR 13W, 27W & 40W HAND LAMPS                 |



**HAND LAMPS** Industrial Duty, Fluorescent with Battery Pack, 13W

Fully portable, compact, lightweight and exceptionally durable, the 1083 battery pack combines a Woodhead 13 watt fluorescent hand lamp with a battery power unit. Designed for use in the most out-of-the-way areas where power is not readily available, battery-powered fluorescent hand lamps provide you with 900 lumens of “cool” operation and diffuse illumination.

**BEST SELLER!**

**13W Hand Lamp**

- on/off switch in handle
- 6' cord
- 23/2 PVC coiled cord

part no. 1083-3B



**Fluorescent Hand Lamps with Battery Pack**

| PART NO.  | CHARGER                | SWITCH | CORD TYPE | COIL CORD LENGTH | LUMENS | LAMP TYPE | REPLACEMENT LAMP |
|-----------|------------------------|--------|-----------|------------------|--------|-----------|------------------|
| 1083-3B   | 120VAC                 | ●      | 23/2 PVC  | 6'               | 900    | PL13/41   | 34-0137          |
| 1083-3B12 | 12VDC                  | ●      | 23/2 PVC  | 6'               | 900    | PL13/41   | 34-0137          |
| 1083-3BD  | DUAL 120VAC AND 12V DC | ●      | 23/2 PVC  | 6'               | 900    | PL13/41   | 34-0137          |

**Replacement Parts**

| PART NO.   | DESCRIPTION                                    |
|------------|--|
| 1083-3BL   | SUPER-SAFEWAY® 13W FLUORESCENT HAND LAMP       |
| 1083-3BP   | SUPER-SAFEWAY BATTERY PACK WITH 120VAC CHARGER |
| 1083-3BP12 | SUPER-SAFEWAY BATTERY PACK WITH 12VDC CHARGER  |
| 37-1200    | BATTERY  |
| 37-7400    | 120VAC CHARGER                                 |
| 37-7410    | 12VDC CHARGER                                  |
| 40-1040B   | CLEAR BUTYRATE TUBE SHIELD ASSEMBLY            |



MOST WOODHEAD PRODUCTS HAVE U.L. AND/OR CSA APPROVALS. FOR A LISTING OF APPROVALS BY PART NUMBER, SEE PAGES 262-269.



# PORTABLE LIGHTING



## HAND LAMPS Industrial Duty, Fluorescent, 4W, 8W, 15W, 30W

For applications that require remote diffuse lighting, single lamp fluorescent hand lamps are ready for the job. The use of T8 and T5 bulbs in a hand lamp design puts the power of a lighting fixture in the palm of your hand.

### BEST SELLERS!

#### 15W Hand Lamp

- on/off switch in handle
- ballast in handle
- lamp type F15T8
- 25' 18/3 SJTW cord

part no. 1003-3



#### 30W Hand Lamp

- on/off switch in handle
- ballast on cord
- lamp type F30T8
- 25' 18/3 SJTW cord

part no. 1013-3



## Fluorescent Hand Lamps

| PART NO. | SWITCH | FIXTURE VOLTAGE | LAMP WATTAGE | CORD TYPE | BALLAST LOCATION | NEMA CONFIGURATION | CORD LENGTH | LUMENS | LAMP TYPE | REPLACEMENT LAMP |
|----------|--------|-----------------|--------------|-----------|------------------|--------------------|-------------|--------|-----------|------------------|
| 1003-3   | ●      | 120V/60HZ       | 15W          | 18/3 SJTW | HANDLE           | NEMA 5-15          | 25'         | 910    | F15T8     | 34-1910          |
| 1005-3   | ●      | 120V/60HZ       | 15W          | 18/3 SJTW | HANDLE           | NEMA 5-15          | 50'         | 910    | F15T8     | 34-1910          |
| 1013-3   | ●      | 120V/60HZ       | 30W          | 18/3 SJTW | CORD             | NEMA 5-15          | 25'         | 2000   | F30/T8    | 34-2310          |
| 1015-3   | ●      | 120V/60HZ       | 30W          | 18/3 SJTW | CORD             | NEMA 5-15          | 50'         | 2000   | F30/T8    | 34-2310          |
| 1045     |        | 120V/60HZ       | 4W           | 18/3 SJTW | CORD             | NEMA 5-15          | 18'         | 95     | F4T5      | 34-6890          |
| 1049     |        | 120V/60HZ       | 8W           | 18/3 SJTW | CORD             | NEMA 5-15          | 18'         | 300    | F8T5      | 34-3630          |
| 1003-3-P | ●      | 230V/50HZ       | 15W          | 18/3 SJTW | HANDLE           | —                  | 25'         | 910    | F15T8     | 34-1910          |

## Replacement Parts

| PART NO. | DESCRIPTION  |
|----------|--|
| 1003-3HO | 100-3-3 WITHOUT CORD; FIXTURE ONLY                         |
| 34-1910  | 15W T8 LAMP  |
| 34-2310  | 30W T8 LAMP  |
| 34-6890  | 4W T5 LAMP   |
| 34-3630  | 8W T5 LAMP   |
| 40-1120  | SHIELD ASSEMBLY FOR 15W SUPER SAFEWAY® HAND LAMP           |
| 40-1140  | SHIELD ASSEMBLY FOR 30W SUPER SAFEWAY HAND LAMP            |
| 70-1351  | NYLON CAP HOOK FOR 15W AND 30W SUPER SAFEWAY HAND LAMPS    |
| 70-1352  | NYLON HANDLE HOOK FOR 15W AND 30W SUPER SAFEWAY HAND LAMPS |



MOST WOODHEAD PRODUCTS HAVE U.L. AND/OR CSA APPROVALS.  
FOR A LISTING OF APPROVALS BY PART NUMBER, SEE PAGES 262-269.



**HAND LAMPS** Wet Location, Fluorescent, 13W, 26W, 40W

Watertite® fluorescent hand lamps in 13, 26 and 40 watt versions provide you with cool diffuse light and a wet location-rated enclosure. Woodhead construction including switches enclosed under a rubber gasket, protects against moisture and contaminants and lead to a NEMA rated hand lamp.

**BEST SELLERS!**

**13W Hand Lamp**

- on/off switch in fixture
- 25' 16/3 SJT00W cord
- lamp type PL13/41

part no. 1913SA



**40W Hand Lamp**

- on/off switch in handle
- 25' 16/3 SJT00W cord
- lamp type PL-L40/41

part no. 1940SA

**Fluorescent Hand Lamps** All lamps have on/off switch and ballast in fixture.

| PART NO. | FIXTURE VOLT. | LAMP WATTAGE | CORD TYPE   | CORD LENGTH | LUMENS | LAMP TYPE     | REPLACEMENT LAMP |
|----------|---------------|--------------|-------------|-------------|--------|---------------|------------------|
| 1913SA   | 120V/60HZ     | 13W          | 16/3 SJT00W | 25'         | 900    | PL13/41       | 34-0390          |
| 1913SB   | 120V/60HZ     | 13W          | 16/3 SJT00W | 50'         | 900    | PL13/41       | 34-0390          |
| 1926SA   | 120V/60HZ     | 26W          | 16/3 SJT00W | 25'         | 1800   | PL-C 26/41/4P | 34-0391          |
| 1926SB   | 120V/60HZ     | 26W          | 16/3 SJT00W | 50'         | 1800   | PL-C 26/41/4P | 34-0391          |
| 1940SA   | 120V/60HZ     | 40W          | 16/3 SJT00W | 25'         | 3150   | PL-L 40/41    | 34-0120          |
| 1940SB   | 120V/60HZ     | 40W          | 16/3 SJT00W | 50'         | 3150   | PL-L 40/41    | 34-0120          |

**Replacement Parts**

| PART NO. | DESCRIPTION                                       |
|----------|---|
| 36-2080  | SHIELD ASSY. FOR 40W WATERTITE® HAND LAMP         |
| 36-2081  | SHIELD ASSY. FOR 13W AND 26W WATERTITE® HAND LAMP |
| 1913SHO  | 1913S WITHOUT CORD; FIXTURE ONLY                  |
| 1926SHO  | 1926S WITHOUT CORD; FIXTURE ONLY                  |
| 1940SHO  | 1940S WITHOUT CORD; FIXTURE ONLY                  |



MOST WOODHEAD PRODUCTS HAVE U.L. AND/OR CSA APPROVALS. FOR A LISTING OF APPROVALS BY PART NUMBER, SEE PAGES 262-269.

# PORTABLE LIGHTING



## HAND LAMPS Commercial Duty, Incandescent, 100W

Heavy-duty construction and long operating life in industrial applications sets Woodhead incandescent hand lamps apart from all others. Features #8 gauge zinc-plated guards and phenolic plastic handles to protect bulbs and electrical components.



### BEST SELLERS!

#### 100W Hand Lamp

- on/off switch in handle
- utility outlet in handle
- screw release guard with reflector
- 25' 16/3 SJTOW cord

part no. 271USA163



#### 100W Hand Lamp

- switch
- side outlet
- no cord

part no. 271US

## Incandescent Hand Lamps

| PART NO.  | SIDE OUTLET | SWITCH | FIXTURE VOLTAGE | MAXIMUM LAMP WATTAGE | CORD TYPE  | NEMA CONFIGURATION | CORD LENGTH |
|-----------|-------------|--------|-----------------|----------------------|------------|--------------------|-------------|
| 271US     | ●           | ●      | 240V MAX        | 100W                 | —          | —                  | —           |
| 271USA163 | ●           | ●      | 240V MAX        | 100W                 | 16/3 SJTOW | NEMA 5-15          | 25'         |
| 271USB163 | ●           | ●      | 240V MAX        | 100W                 | 16/3 SJTOW | NEMA 5-15          | 50'         |
| 271S      | —           | ●      | 240V MAX        | 100W                 | —          | —                  | —           |
| 271SA163  | —           | ●      | 240V MAX        | 100W                 | 16/3 SJTOW | NEMA 5-15          | 25'         |
| 271SB163  | —           | ●      | 240V MAX        | 100W                 | 16/3 SJTOW | NEMA 5-15          | 50'         |
| 271U      | ●           | —      | 240V MAX        | 100W                 | —          | —                  | —           |
| 271UA163  | ●           | —      | 240V MAX        | 100W                 | 16/3 SJTOW | NEMA 5-15          | 25'         |
| 271UB163  | ●           | —      | 240V MAX        | 100W                 | 16/3 SJTOW | NEMA 5-15          | 50'         |



MOST WOODHEAD PRODUCTS HAVE U.L. AND/OR CSA APPROVALS. FOR A LISTING OF APPROVALS BY PART NUMBER, SEE PAGES 262-269.





## HAND LAMPS Commercial Duty, Incandescent, 75W-300W

### BUILD A HAND LAMP

To customize your Woodhead hand lamp, first select a handle assembly from the chart below, then choose the best guard for your application.



### STEP 1 Select a Handle

|                    | SWITCH  | OUTLET  | SWITCH/OUTLET |
|--------------------|---------|---------|---------------|
|                    |         |         |               |
| <b>NO CORD</b>     | 270-1   | 270-2   | 270-3         |
| <b>25 FT. CORD</b> | 42-4390 | 42-4380 | 42-4370       |
| <b>50 FT. CORD</b> | 43-4391 | 43-4381 | 43-4371       |

### STEP 2 Select a Guard

| GUARD TYPE                     | CLOSED                   | CLOSED                   | CLOSED                      | CLOSED                      | CLOSED                      | CLOSED                      |
|--------------------------------|--------------------------|--------------------------|-----------------------------|-----------------------------|-----------------------------|-----------------------------|
| ACCESSIBILITY                  | SCREW RELEASE            | SCREW RELEASE            | QUICK OPEN                  | QUICK OPEN                  | SCREW RELEASE               | SCREW RELEASE               |
| REFLECTOR                      |                          | ●                        |                             | ●                           |                             | ●                           |
| LAMP TYPE(S)                   | 75-100W<br>A19, A21, A23 | 75-100W<br>A19, A21, A23 | 75-100W<br>A19, A21, A23    | 75-100W<br>A19, A21, A23    | 200-300W<br>A21, PS30, PS25 | 200-300W<br>A21, PS30, PS25 |
|                                |                          |                          |                             |                             |                             |                             |
| <b>ZINC PLATED STEEL</b>       | 1152                     | 1156                     | 1162                        | 1166                        | 1153                        | 1157                        |
| <b>RUBBER COATED INSULATED</b> | 1152IG                   | 1156IG                   | 1162IG                      | —                           | 1153IG                      | 1157IG                      |
| GUARD TYPE                     | OPEN                     | OPEN                     | OPEN                        | OPEN                        | CLOSED NYLON                | OPEN                        |
| ACCESSIBILITY                  | SCREW RELEASE            | SCREW RELEASE            | SCREW RELEASE               | SCREW RELEASE               | QUICK OPEN                  | SCREW RELEASE               |
| REFLECTOR                      |                          | ●                        |                             | ●                           | ●                           |                             |
| LAMP TYPE(S)                   | 75-100W<br>A19, A21, A23 | 75-100W<br>A19, A21, A23 | 200-300W<br>A21, PS30, PS25 | 200-300W<br>A21, PS30, PS25 | 75-100W<br>A19, A21, A23    | PAR 38                      |
|                                |                          |                          |                             |                             |                             |                             |
| <b>ZINC PLATED STEEL</b>       | 1160                     | 1164                     | 1161                        | 1165                        | 1168                        | 1181                        |
| <b>RUBBER COATED INSULATED</b> | 1160IG                   | 1164IG                   | 1161IG                      | 1165IG                      | —                           | —                           |

### Replacement Parts

| PART NO. | DESCRIPTION   |
|----------|---|
| 179      | SOCKET ASSEMBLY FOR SAFEWAY® INCANDESCENT HAND LAMP |
| 279      | SWITCH FOR SAFEWAY INCANDESCENT HAND LAMP           |

UL SR MOST WOODHEAD PRODUCTS HAVE U.L. AND/OR CSA APPROVALS. FOR A LISTING OF APPROVALS BY PART NUMBER, SEE PAGES 262-269.



**HAND LAMPS** Commercial Duty, Incandescent, 150W

Safety Yellow® incandescent hand lamps provide maximum economy and worker safety for commercial duty environments. The lamps provide increased light output and grounded metal guards, an elastomer grip on the handle, easy-access guard for easy change-out of bulb and will withstand the toughest of work environments.



**BEST SELLER!**

**150W Max. Hand Lamp**

- on/off switch in handle
- easy-access guard for changing bulb
- convenient rear outlet
- 25' 16/3 SJTW cord

part no. WT6C-25

**Incandescent Hand Lamps** Bulb not included.

| PART NO. | SIDE OUTLET | SWITCH | MAXIMUM LAMP WATTAGE | CORD TYPE | PLUG TYPE | CORD LENGTH |
|----------|-------------|--------|----------------------|-----------|-----------|-------------|
| WT6C-25  | ●           | ●      | 150W (A-21)          | 16/3 SJTW | NEMA 5-15 | 25'         |
| WT6C-50  | ●           | ●      | 150W (A-21)          | 16/3 SJTW | NEMA 5-15 | 50'         |



MOST WOODHEAD PRODUCTS HAVE U.L. AND/OR CSA APPROVALS. FOR A LISTING OF APPROVALS BY PART NUMBER, SEE PAGES 262-269.



## HAND LAMPS Commercial Duty, Fluorescent, 26W

Safety Yellow® fluorescent hand lamps provide maximum economy and worker safety for commercial duty environments. The lamps feature 26 watts of fluorescent light output, an elastomer grip on the handle and value-driven performance while withstanding the toughest work environments.



### BEST SELLER!

#### 26W Hand Lamp

- on/off switch in handle
- 25' 18/3 SJTW cord

part no. WT6F-25

### Fluorescent Hand Lamps

| PART NO. | SWITCH | FIXTURE VOLTAGE | LAMP WATTAGE | CORD TYPE | CORD LENGTH | LUMENS | LAMP TYPE     | REPLACEMENT LAMP |
|----------|--------|-----------------|--------------|-----------|-------------|--------|---------------|------------------|
| WT6F-25  | ●      | 120V/60HZ       | 26W          | 18/3 SJTW | 25'         | 1800   | PL-C 26/41/4P | 34-0391          |
| WT6F-50  | ●      | 120V/60HZ       | 26W          | 18/3 SJTW | 50'         | 1800   | PL-C 26/41/4P | 34-0391          |



MOST WOODHEAD PRODUCTS HAVE U.L. AND/OR CSA APPROVALS. FOR A LISTING OF APPROVALS BY PART NUMBER, SEE PAGES 262-269.



## HAND LAMPS General Duty, Incandescent, 100W

Pro-Yellow® incandescent hand lamps provide maximum economy and worker safety for general duty environments. The lamps provide increased light output, will withstand tough work environments, and features a rotatable guard for easy change-out of bulbs.



### BEST SELLER!

#### 100W Hand Lamp

- on/off switch in handle
- hide-away guard for changing bulb
- 20' 18/3 SJTW cord

part no. WT3C-20

### Incandescent Hand Lamps Bulb not included.

| PART NO. | SWITCH | MAXIMUM LAMP WATTAGE | CORD TYPE | CORD LENGTH |
|----------|--------|----------------------|-----------|-------------|
| WT3C-20  | ●      | 100W (A21)           | 18/3 SJTW | 20'         |

#### NEC® REFERENCE

NEC2002 – ARTICLE 527.4 (D) RECEPTACLES. ALL RECEPTACLES SHALL BE OF THE GROUNDING TYPE. UNLESS INSTALLED IN A CONTINUOUS GROUNDED METAL RACEWAY OR METAL COVERED CORD, ALL BRANCH CIRCUITS SHALL CONTAIN A SEPARATE EQUIPMENT GROUNDING CONDUCTOR, AND ALL RECEPTACLES SHALL BE ELECTRONICALLY CONNECTED TO THE EQUIPMENT-GROUNDING CONDUCTORS. RECEPTACLES ON CONSTRUCTION SITES SHALL NOT BE INSTALLED ON BRANCH CIRCUITS THAT SUPPLY TEMPORARY LIGHTING. RECEPTACLES SHALL NOT BE CONNECTED TO THE SAME UNGROUNDED CONDUCTOR OF MULTI-WIRE CIRCUITS THAT SUPPLY TEMPORARY LIGHTING.

"THE INTENT OF THE BRANCH CIRCUIT PROVISIONS IN 527.4 (D) IS TO REQUIRE SEPARATE UNGROUNDED CONDUCTORS FOR LIGHTING AND RECEPTACLE LOADS SO THAT THE ACTIVATION OF A FUSE, CIRCUIT BREAKER, OR GROUND-FAULT CIRCUIT INTERRUPTER, DUE TO A FAILURE OR EQUIPMENT OVERLOAD, WILL NOT DE-ENERGIZE THE LIGHTING CIRCUIT." (NATIONAL ELECTRICAL CODE® HANDBOOK, NINTH EDITION)



MOST WOODHEAD PRODUCTS HAVE U.L. AND/OR CSA APPROVALS. FOR A LISTING OF APPROVALS BY PART NUMBER, SEE PAGES 262-269.





## HAND LAMPS General Duty, Fluorescent, 13W

Pro-Yellow® fluorescent hand lamps provide maximum economy and worker safety for general duty environments. The lamps provide 13 watts of fluorescent light output, an elastomer grip on the handle and value-driven performance while withstanding tough work environments.



### BEST SELLER!

#### 13W Hand Lamp

- 20' 18/3 SJTW cord
- on/off switch in handle

part no. WT3F-20

### Fluorescent Hand Lamp

| PART NO.               | SWITCH | FIXTURE VOLTAGE | LAMP WATTAGE | CORD TYPE | CORD LENGTH | LUMENS | LAMP TYPE | REPLACEMENT LAMP |
|------------------------|--------|-----------------|--------------|-----------|-------------|--------|-----------|------------------|
| WT3F-20                | ●      | 120V/60HZ       | 13W          | 18/3 SJTW | 20'         | 900    | PL13/41   | 34-0390          |
| WT3F-20NS <sup>1</sup> |        | 120V/60HZ       | 13W          | 18/3 SJTW | 20'         | 900    | PL13/41   | 34-0390          |

<sup>1</sup> PORTABLE LIGHTING EQUIPMENT USED IN COMMERCIAL GARAGES, REPAIR AND STORAGE SHALL BE OF AN UNSWITCHED TYPE AND SHALL NOT PROVIDE MEANS FOR PLUG-IN OF ATTACHMENT PLUG PER THE 2002 EDITION OF THE NATIONAL ELECTRICAL CODE®.



MOST WOODHEAD PRODUCTS HAVE U.L. AND/OR CSA APPROVALS. FOR A LISTING OF APPROVALS BY PART NUMBER, SEE PAGES 262-269.



## WIDE AREA LAMPS Hazardous Duty, Fluorescent, 80W, 128W

Task lighting in hazardous locations demands the utmost care. The Woodhead Tubelite® portable hazardous-duty wide area purge light actively prevents the entry of explosive vapors into the unit by continuously purging potentially dangerous gases from the fixture. This is accomplished by attaching a supply of air through the light, certifying it by CSA for Class I, Division I, Groups C&D (flammable gasses and vapors) and Class II, Division I, Groups F&G (ignitable dust).



### BEST SELLERS!

#### 80W Wide Area Tube Light

- 6300 lumens
- 25' 16/3 S00W cord

part no. 2030PLX25

## Fluorescent Wide Area Tube Light

| PART NO.  | FIXTURE VOLTAGE | LAMP WATTAGE | CORD TYPE | CORD LENGTH | LUMENS | LAMP TYPE  | REPLC. LAMP |
|-----------|-----------------|--------------|-----------|-------------|--------|------------|-------------|
| 2000PLX25 | 120V/60HZ       | 128W         | 16/3 S00W | 25'         | 11400  | F32/T8     | 34-3730     |
| 2000PLX50 | 120V/60HZ       | 128W         | 16/3 S00W | 50'         | 11400  | F32/T8     | 34-3730     |
| 2030PLX25 | 120V/60HZ       | 80W          | 16/3 S00W | 25'         | 6300   | PL-L 40/41 | 34-0120     |
| 2030PLX50 | 120V/60HZ       | 80W          | 16/3 S00W | 50'         | 6300   | PL-L 40/41 | 34-0120     |

## Replacement Parts

| PART NO. | DESCRIPTION                                |
|----------|--|
| 36-2005  | SHIELD ASSEMBLY FOR 128W HAZTEX TUBE LIGHT |
| 36-2006  | SHIELD ASSEMBLY FOR 80W HAZTEX TUBE LIGHT  |



MOST WOODHEAD PRODUCTS HAVE U.L. AND/OR CSA APPROVALS.  
FOR A LISTING OF APPROVALS BY PART NUMBER, SEE PAGES 262-269.



## WIDE AREA LAMPS Industrial Duty, Fluorescent, 80W, 100W, 128W

Lighting requirements for wide area illumination are a bright spot for Woodhead Tubelite® fluorescent wide area lamps. 80, 100 and 128 watt formats are ideal for lighting in tunnels, passageways, large tanks and vessels or wherever wide area industrial lighting is needed.



### BEST SELLER!

#### 80W Wide Area Tube Light

- 5-15 NEMA plug
- 6300 lumens
- 120V/60HZ
- 25' 16/3 SOOW cord

part no. 2031

### Fluorescent Wide Area Tube Light

| PART NO. | FEED THRU OUTLET | FIXTURE VOLTAGE | LAMP WATTAGE | CORD TYPE | NEMA CONFIGURATION <sup>1</sup> | CORD LENGTH |      | LUMENS | LAMP TYPE  | REPLC. LAMP |
|----------|------------------|-----------------|--------------|-----------|---------------------------------|-------------|------|--------|------------|-------------|
|          |                  |                 |              |           |                                 | PRIM.       | SEC. |        |            |             |
| 2001     | ●                | 120V/60HZ       | 128W         | 16/3 SOOW | NEMA 5-15                       | 25'         | 6"   | 11400  | F32/T8     | 34-3730     |
| 2002     | ●                | 120V/60HZ       | 128W         | 16/3 SOOW | NEMA 5-15                       | 4'          | 6"   | 11400  | F32/T8     | 34-3730     |
| 2000     |                  | 120V/60HZ       | 128W         | 16/3 SOOW | NEMA 5-15                       | 25'         | —    | 11400  | F32/T8     | 34-3730     |
| 2003     |                  | 120V/60HZ       | 128W         | 16/3 SOOW | NEMA 5-15                       | 3'          | —    | 11400  | F32/T8     | 34-3730     |
| 2001-E   | ●                | 110V/50HZ       | 128W         | 16/3 SOOW | —                               | 25'         | 6"   | 11400  | F32/T8     | 34-3730     |
| 2031     | ●                | 120V/60HZ       | 80W          | 16/3 SOOW | NEMA 5-15                       | 25'         | 6"   | 6300   | PL-L 40/41 | 34-0120     |
| 2032     | ●                | 120V/60HZ       | 80W          | 16/3 SOOW | NEMA 5-15                       | 4'          | 6"   | 6300   | PL-L 40/41 | 34-0120     |
| 2030     |                  | 120V/60HZ       | 80W          | 16/3 SOOW | NEMA 5-15                       | 25'         | —    | 6300   | PL-L 40/41 | 34-0120     |
| 2031-P   | ●                | 230V/50HZ       | 80W          | 16/3 SOOW | —                               | 25'         | 6"   | 6300   | PL-L 40/41 | 34-0120     |
| 2011     | ●                | 120V/60HZ       | 100W         | 16/3 SOOW | NEMA 5-15                       | 25'         | 6"   | 8320   | F25/T8     | 34-3740     |
| 2012     | ●                | 120V/60HZ       | 100W         | 16/3 SOOW | NEMA 5-15                       | 4'          | 6"   | 8320   | F25/T8     | 34-3740     |
| 2010     |                  | 120V/60HZ       | 100W         | 16/3 SOOW | NEMA 5-15                       | 25'         | —    | 8320   | F25/T8     | 34-3740     |

<sup>1</sup>ALL LAMPS FEATURE WATERTITE® PLUGS

### Replacement Parts

| PART NO. | DESCRIPTION                                      |
|----------|--|
| 36-2001  | SHIELD ASSEMBLY FOR 128W TUBELITE                |
| 36-2002  | SHIELD ASSEMBLY FOR 100W TUBELITE                |
| 36-2004  | SHIELD ASSEMBLY FOR 80W TUBELITE                 |
| 42-1062  | TEAR OFF SHIELD COVER FOR SUPER-SAFEWAY TUBELITE |



MOST WOODHEAD PRODUCTS HAVE U.L. AND/OR CSA APPROVALS. FOR A LISTING OF APPROVALS BY PART NUMBER, SEE PAGES 262-269.



## TUBELITE® WORKCENTER

The TubeLite WorkCenter provides a single source for area lighting, electrical power and pressurized air distribution to increase worker productivity. Each work center combines our TubeLite stand, 3 duplex receptacles and 4 air supply hook-ups with feed-thru electrical and air outlets to allow “daisy chaining” the centers together.

### BEST SELLERS!

#### TubeLite WorkCenter

- Super-Safeway® 5-15 NEMA plug
- 4 dolly wheels
- single phase
- 12/3 S00W cord

part no. 2320



TubeLite Wire Light Stand

- rubber feet

part no. 2370

TubeLite WorkCenter TubeLites sold separately (see p. 26-27).

| PART NO.                | FIXTURE VOLTAGE | RUBBER FEET | NO. OF WHEELS | CORD PHASE | NEMA TYPE | CORD CONFIGURATION       | LENGTH |
|-------------------------|-----------------|-------------|---------------|------------|-----------|--------------------------|--------|
| 2370                    | —               | ●           | —             | —          | —         | —                        | —      |
| 2300                    | 120VAC          | ●           | —             | SINGLE     | 12/3 S00W | SUPER-SAFEWAY® NEMA 5-20 | 20'    |
| 2316                    | 120VAC          | ●           | 2             | SINGLE     | 12/3 S00W | SUPER-SAFEWAY NEMA 5-20  | 20'    |
| 2320                    | 120VAC          | ●           | 4             | SINGLE     | 12/3 S00W | SUPER-SAFEWAY NEMA 5-20  | 20'    |
| 2304F-30TZ <sup>2</sup> | 120VAC          | ●           | —             | 3          | 10/5 S0W  | SAFEWAY® NEMA L21-30     | 20'    |
| 2306F-30TZ <sup>1</sup> | 120VAC          | ●           | —             | 3          | 10/5 S0W  | SAFEWAY NEMA L21-30      | 20'    |
| 2316F-30TZ <sup>1</sup> | 120VAC          | ●           | 2             | 3          | 10/5 S0W  | SAFEWAY NEMA L21-30      | 20'    |
| 2320F-20TZ              | 120VAC          | ●           | 4             | 3          | 10/5 S0W  | SAFEWAY NEMA L21-20      | 20'    |
| 2326F-30TZ <sup>1</sup> | 120VAC          | ●           | 4             | 3          | 10/5 S0W  | SAFEWAY NEMA L21-30      | 20'    |

<sup>1</sup> CIRCUIT BREAKER PROTECTION

<sup>2</sup> CIRCUIT FUSE PROTECTION



MOST WOODHEAD PRODUCTS HAVE U.L. AND/OR CSA APPROVALS. FOR A LISTING OF APPROVALS BY PART NUMBER, SEE PAGES 262-269.





**WIDE AREA LAMPS** Wet Location, HID Lighting, 70W, 100W

The need for temporary wide area lighting can arise in virtually any application. That is why Woodhead offers HID lighting in the form of the 100 watt high-pressure sodium and the 70 watt metal halide lights. These lights feature heavy-duty mounting magnets for easy installation and feed-through connector options for “daisy-chaining” lights together in wide area applications.

**BEST SELLERS!**

**High Pressure Sodium Light**

- 5-15 NEMA plug
- heavy duty mounting magnet
- 100W

part no. 8565



**High Pressure Sodium Light**

- same as 8565, with feed thru outlet

part no. 8565F



**HID Lighting**

| PART NO. | FEED THRU OUTLET | LAMP TYPE            | FIXTURE VOLTAGE | LAMP WATTAGE | CORD TYPE  | NEMA CONFIG. | CORD LENGTH |      | LAMP TYPE |
|----------|------------------|----------------------|-----------------|--------------|------------|--------------|-------------|------|-----------|
|          |                  |                      |                 |              |            |              | PRIM.       | SEC. |           |
| 8565     |                  | HIGH PRESSURE SODIUM | 120V/60HZ       | 100W         | 16/3 SJTOW | NEMA 5-15    | 10'         | —    | —         |
| 8565F    | ●                | HIGH PRESSURE SODIUM | 120V/60HZ       | 100W         | 16/3 SJTOW | NEMA 5-15    | 10'         | 1'   | —         |
| 8565-MH  |                  | METAL HALIDE         | 120V/60HZ       | 70W          | 16/3 SJTOW | NEMA 5-15    | 10'         | —    | MH70      |
| 8565F-MH | ●                | METAL HALIDE         | 120V/60HZ       | 70W          | 16/3 SJTOW | NEMA 5-15    | 10'         | 1'   | MH70      |



MOST WOODHEAD PRODUCTS HAVE U.L. AND/OR CSA APPROVALS. FOR A LISTING OF APPROVALS BY PART NUMBER, SEE PAGES 262-269.



## WIDE AREA LAMPS Wet Location, Incandescent Floodlight, 500W

Woodhead offers an extensive line of wet location lighting solutions that meet and exceed the OSHA requirements for wet location use. U.L. listed at NEMA 4X for damp locations, these enclosed and gasketed Watertite® wide area lights are the tough industrial tools you can rely on for the desired level of illumination and diffuse light patterns needed in wet work areas.

### BEST SELLER!

Floodlight with 25' cord

- 16/3 SOOW cord
- 120VAC

part no. 8570P-56A163



## Incandescent Floodlights Lamps not included.

| PART NO.     | FIXTURE VOLTAGE | LAMP WATTAGE | CORD TYPE | CORD LENGTH | LAMP TYPE |
|--------------|-----------------|--------------|-----------|-------------|-----------|
| 8570P-56A163 | 120VAC          | 500          | 16/3 SOOW | 25'         | PAR56     |
| 8570P-56B163 | 120VAC          | 500          | 16/3 SOOW | 50'         | PAR56     |
| 8570P-56D163 | 120VAC          | 500          | 16/3 SOOW | 100'        | PAR56     |
| 8570P-56     | 120VAC          | 500          | —         | —           | PAR56     |

MOST WOODHEAD PRODUCTS HAVE U.L. AND/OR CSA APPROVALS. FOR A LISTING OF APPROVALS BY PART NUMBER, SEE PAGES 262-269.



## WIDE AREA LAMPS Industrial Duty, Quartz Halogen Floodlights, 100W, 500W, 1000W

The need for temporary wide area lighting can arise in virtually any application, which is why Woodhead offers the dual 500 watt portable floodlight stanchion and the 500 and 1000 watt halogen floodlights. These lights feature heavy-duty steel guards and steel frames that protect the lamps and support the fixture for rigorous use.

### BEST SELLERS!

#### Halogen Floodlight

- 5-15 NEMA plug
- 500W lamp
- 25' 16/3 SOOW cord

part no. 8506 (shown right)

#### Halogen Floodlight

- same as above, except with magnet mount

part no. 8506M



#### Halogen Floodlight Stanchion

- 5-20 NEMA plug
- switch
- 1000W (two 500W fixtures)
- convenience outlet
- 1.5' 12/3 SOOW cord

part no. SBG2500 (shown above)

### Quartz Halogen Floodlights

| PART NO.           | GFCI OUTLET BOX | SWITCH | MOUNT     | FIXTURE VOLTAGE | LAMP WATTAGE | CORD TYPE | NEMA CONFIGURATION       | CORD LENGTH |
|--------------------|-----------------|--------|-----------|-----------------|--------------|-----------|--------------------------|-------------|
| 8506               |                 |        | STAND     | 120VAC          | 500W         | 16/3 SOOW | SUPER-SAFEWAY® NEMA 5-15 | 25'         |
| 8506M              |                 |        | MAGNET    | 120VAC          | 500W         | 16/3 SOOW | SUPER-SAFEWAY NEMA 5-15  | 25'         |
| 8500 <sup>1</sup>  |                 |        | STAND     | 12VAC/DC        | 100W         | 16/3 SOOW | SUPER-SAFEWAY NON-NEMA   | 25'         |
| 8500M <sup>1</sup> |                 |        | MAGNET    | 12VAC/DC        | 100W         | 16/3 SOOW | SUPER-SAFEWAY NON-NEMA   | 25'         |
| 8511               |                 |        | STAND     | 120VAC          | 1000W        | 16/3 SOOW | SUPER-SAFEWAY NEMA 5-15  | 25'         |
| SBS2500            |                 | ●      | STANCHION | 120VAC          | 500W (2)     | 12/3 SOOW | WATERTITE® NEMA 5-20     | 1.5'        |
| SBG2500            | ●               | ●      | STANCHION | 120VAC          | 500W (2)     | 12/3 SOOW | WATERTITE® NEMA 5-20     | 1.5'        |

<sup>1</sup> FOR USE WITH LOW VOLTAGE WORKSTATION ON PAGE 13

### Replacement Parts

| PART NO. | DESCRIPTION                                 |
|----------|---|
| 200      | MAGNETIC MOUNTING ASSEMBLY (2 MAGNETS)      |
| 34-0040  | LAMP FOR SUPER-SAFEWAY 1000W QUARTZ HALOGEN |
| 34-0190  | LAMP FOR SUPER-SAFEWAY 100W QUARTZ HALOGEN  |
| 34-0230  | LAMP FOR SUPER-SAFEWAY 500W QUARTZ HALOGEN  |

| PART NO. | DESCRIPTION  |
|----------|--|
| 8505     | 500W QUARTZ HALOGEN FIXTURE WITHOUT GUARD              |
| 8507     | METAL GUARD FOR SUPER-SAFEWAY 500W+100W QUARTZ HALOGEN |
| 8510     | 1000W QUARTZ HALOGEN FIXTURE WITHOUT GUARD             |
| 8512     | METAL GUARD FOR SUPER-SAFEWAY 1000W QUARTZ HALOGEN     |



MOST WOODHEAD PRODUCTS HAVE U.L. AND/OR CSA APPROVALS. FOR A LISTING OF APPROVALS BY PART NUMBER, SEE PAGES 262-269.

# PORTABLE LIGHTING



## WIDE AREA LAMPS Industrial Duty, Fluorescent, 30W, 50W, 64W, 80W, 160W

Lighting requirements for wide area illumination are a bright spot for Woodhead Super-Safeway® fluorescent twin lamps. Both T-8 and PL formats are ideal for lighting in tunnels, passageways, large tanks and vessels or wherever wide area industrial lighting is needed.



### BEST SELLERS!

#### Fluorescent Feed Thru Lamp

- 25' primary/6" secondary cord length
- 5700 lumens
- Two 32W T8 lamps

part no. 1351 (shown)

#### Fluorescent Feed Thru Lamp

- 50' primary/6" secondary cord length
- 4160 lumens
- Two 25W T8 lamps

part no. 1336

### Fluorescent Wide Area Twin Lamps All lamp types include a 16/3 SJOW cord.

| PART NO. | FEED THRU OUTLET | FIXTURE VOLTAGE | FIXTURE WATTAGE | CORD LENGTH |      | LUMENS | LAMP TYPE  | REPL. LAMP |
|----------|------------------|-----------------|-----------------|-------------|------|--------|------------|------------|
|          |                  |                 |                 | PRIM.       | SEC. |        |            |            |
| 1351     | ●                | 120V/60HZ       | 64W             | 25'         | 6"   | 5700   | F32/T8     | 34-3730    |
| 1352     | ●                | 120V/60HZ       | 64W             | 4'          | 6"   | 5700   | F32/T8     | 34-3730    |
| 1350     | ●                | 120V/60HZ       | 64W             | 25'         | —    | 5700   | F32/T8     | 34-3730    |
| 1351-E'  | ●                | 110V/50HZ       | 64W             | 25'         | 6"   | 5700   | F32/T8     | 34-3730    |
| 1352-E'  | ●                | 110V/50HZ       | 64W             | 4'          | 6"   | 5700   | F32/T8     | 34-3730    |
| 1336     | ●                | 120V/60HZ       | 50W             | 25'         | 6"   | 4160   | F25/T8     | 34-3740    |
| 1337     | ●                | 120V/60HZ       | 50W             | 4'          | 6"   | 4160   | F25/T8     | 34-3740    |
| 1326     | ●                | 120V/60HZ       | 50W             | 25'         | —    | 4160   | F25/T8     | 34-3740    |
| 1336-E'  | ●                | 110V/50HZ       | 50W             | 25'         | 6"   | 4160   | F25/T8     | 34-3740    |
| 1336-P'  | ●                | 230V/50HZ       | 50W             | 25'         | 6"   | 4160   | F25/T8     | 34-3740    |
| 1335     | ●                | 120V/60HZ       | 30W             | 4'          | 6"   | 1820   | F15T8      | 34-1910    |
| 1334     | ●                | 120V/60HZ       | 30W             | 25'         | 6"   | 1820   | F15T8      | 34-1910    |
| 1324     | ●                | 120V/60HZ       | 30W             | 25'         | —    | 1820   | F15T8      | 34-1910    |
| 1334-E'  | ●                | 110V/50HZ       | 30W             | 25'         | 6"   | 1820   | F15T8      | 34-1910    |
| 1324-E'  | ●                | 110V/50HZ       | 30W             | 25'         | —    | 1820   | F15T8      | 34-1910    |
| 1324-P'  | ●                | 230V/50HZ       | 30W             | 25'         | —    | 1820   | F15T8      | 34-1910    |
| 1051-PL  | ●                | 120V/60HZ       | 80W             | 25'         | 6"   | 6300   | PL-L 40/41 | 34-0120    |
| 1052-PL  | ●                | 120V/60HZ       | 80W             | 4'          | 6"   | 6300   | PL-L 40/41 | 34-0120    |
| 1050-PL  | ●                | 120V/60HZ       | 80W             | 25'         | —    | 6300   | PL-L 40/41 | 34-0120    |
| 1061-PL  | ●                | 120V/60HZ       | 160W            | 25'         | 6"   | 12600  | PL-L 40/41 | 34-0120    |
| 1062-PL  | ●                | 120V/60HZ       | 160W            | 4'          | 6"   | 12600  | PL-L 40/41 | 34-0120    |
| 1060-PL  | ●                | 120V/60HZ       | 160W            | 25'         | —    | 12600  | PL-L 40/41 | 34-0120    |

<sup>1</sup> UNIT SHIPPED WITHOUT PLUG



MOST WOODHEAD PRODUCTS HAVE U.L. AND/OR CSA APPROVALS. FOR A LISTING OF APPROVALS BY PART NUMBER, SEE PAGES 262-269.





## WIDE AREA LAMPS Industrial Duty, Low Voltage, Fluorescent, 60W, 64W, 80W

Lighting requirements for wide area illumination are a bright spot for Woodhead Super-Safeway® fluorescent twin lamps. Both T-8 and PL formats are ideal for lighting in tunnels, passageways, large tanks and vessels or wherever wide area industrial lighting is needed.



### BEST SELLER!

#### Fluorescent Wide Area Twin Lamp

- feed thru outlet
- 80W
- low-voltage 12V AC/DC

part no. 1052-PL12

#### Low Voltage Workstation

- for up to 8 lamps in string application

part no. 1640-12  
see page 13



### Fluorescent Wide Area Twin Lamp<sup>1</sup>

| PART NO.  | FEED THRU OUTLET | FIXTURE VOLTAGE | FIXTURE WATTAGE | CORD TYPE  | NEMA CONFIGURATION <sup>1</sup> | CORD LENGTH |      | LUMENS | LAMP TYPE  | REPL. LAMP |
|-----------|------------------|-----------------|-----------------|------------|---------------------------------|-------------|------|--------|------------|------------|
|           |                  |                 |                 |            |                                 | PRIM.       | SEC. |        |            |            |
| 1052-PL12 | ●                | 12VAC/DC        | 80W             | 12/3 SOOW  | NON-NEMA                        | 4'          | 6"   | 6300   | PL-L 40/41 | 34-0120    |
| 1052-12   | ●                | 12VAC/DC        | 64W             | 12/3 SOOW  | NON-NEMA                        | 4'          | 6"   | 5300   | F32/T8     | 34-3730    |
| 1051-PL12 | ●                | 12VAC/DC        | 80W             | 12/3 SOOW  | NON-NEMA                        | 25'         | 6"   | 6300   | PL-L 40/41 | 34-0120    |
| 1051-12   | ●                | 12VAC/DC        | 64W             | 12/3 SOOW  | NON-NEMA                        | 25'         | 6"   | 5300   | F32/T8     | 34-3730    |
| 1050-PL12 |                  | 12VAC/DC        | 80W             | 12/3 SOOW  | NON-NEMA                        | 25'         | —    | 6300   | PL-L 40/41 | 34-0120    |
| 1050-12   |                  | 12VAC/DC        | 64W             | 14/3 SJOOW | NON-NEMA                        | 25'         | —    | 5300   | F32/T8     | 34-3730    |
| 1026-12   |                  | 12V/60HZ        | 50W             | 12/3 SOOW  | NON-NEMA                        | 25'         | —    | 4450   | F15/T8     | 34-3740    |

<sup>1</sup> FOR USE WITH LOW VOLTAGE WORKSTATION ON PAGE 13

### Replacement Parts

| PART NO. | DESCRIPTION                               | PART NO. | DESCRIPTION                       |
|----------|---|----------|-----------------------------------|
| 40-1485  | VELCRO® STRAP AND HOOK ASSEMBLY TWIN TUBE | 70-3602  | SHIELD ASSEMBLY FOR 50W TWIN TUBE |
| 42-1060  | TEAR OFF SHIELD COVER FOR TWIN LAMPS      | 70-3603  | SHIELD ASSEMBLY FOR 30W TWIN TUBE |
| 70-3601  | SHIELD ASSEMBLY FOR 160W TWIN TUBE        | 70-3607  | SHIELD ASSEMBLY FOR 80W TWIN TUBE |



MOST WOODHEAD PRODUCTS HAVE U.L. AND/OR CSA APPROVALS. FOR A LISTING OF APPROVALS BY PART NUMBER, SEE PAGES 262-269.

## PORTABLE LIGHTING



### TEMPORARY LIGHTING Hazardous Duty, Incandescent & Fluorescent, 100W, 26W

Woodhead offers the only portable, hazardous-duty stringlight that is third party (CSA) certified as a complete assembly for use in hazardous areas. Assembly includes 25 ft. lead, 600V rated SOW cord, molded "T" drops spaced at 10 ft. intervals, and various Woodhead Haz-Duty hand lamps.

#### BEST SELLERS!

##### Incandescent Stringlight

- 5-15 NEMA plug
- 45' 12/3 S00W cord
- 18" 14/3 S00W drops
- Class I, Division I, Groups C & D
- Class II, Division I, Groups F & G
- Class I, Zone 1, Group IIB

part no. 340310A



##### Fluorescent Stringlight

- 5-15 NEMA plug
- 65' 12/3 S00W cord
- 18" 14/3 S00W drops
- Class I, Division I, Groups C & D
- Class II, Division I, Groups F & G
- Class I, Zone 1, Group IIB

part no. 342510A



### Incandescent Stringlights

| PART NO. | MAXIMUM WATTAGE | CORD TYPE |           | NEMA CONFIG. | CORD LENGTH | LAMP TYPE | NUMBER OF DROPS |
|----------|-----------------|-----------|-----------|--------------|-------------|-----------|-----------------|
|          |                 | PRIM.     | DROPS     |              |             |           |                 |
| 340310A  | 100W            | 12/3 S00W | 14/3 S00W | NEMA 5-15    | 45'         | A21       | 3               |
| 340510A  | 100W            | 12/3 S00W | 14/3 S00W | NEMA 5-15    | 65'         | A21       | 5               |

### Fluorescent Stringlights

| PART NO. | FIXTURE VOLTAGE | LAMP WATTAGE | CORD TYPE |           | NEMA CONFIG. | CORD LENGTH | LAMP TYPE     | REPL. LAMP | NUMBER OF DROPS |
|----------|-----------------|--------------|-----------|-----------|--------------|-------------|---------------|------------|-----------------|
|          |                 |              | PRIM.     | DROPS     |              |             |               |            |                 |
| 342510A  | 120V/60HZ       | 26W          | 12/3 S00W | 14/3 S00W | NEMA 5-15    | 65'         | PL-C 26/41/4P | 34-0391    | 5               |



MOST WOODHEAD PRODUCTS HAVE U.L. AND/OR CSA APPROVALS. FOR A LISTING OF APPROVALS BY PART NUMBER, SEE PAGES 262-269.



**TEMPORARY LIGHTING** Wet Location, Incandescent & Fluorescent, 100W, 26W

Woodhead offers the industry's only portable stringlight assembly that is CSA certified as a complete assembly for use in wet-location areas. Assembly includes 600V rated SOW cord, molded "T" drops, and various Woodhead wet-location hand lamps.

**BEST SELLERS!**

**Incandescent Stringlight**

- 45' 12/3 S00W cord
- 18" 14/3 S00W drops

part no. 380310A



**Fluorescent Stringlight**

- 26W
- 115' cord

part no. 387010A

**Incandescent Stringlights**

| PART NO. | MAXIMUM FIXTURE WATTAGE | CORD TYPE |           | CORD LENGTH | LAMP TYPE | NUMBER OF DROPS |
|----------|-------------------------|-----------|-----------|-------------|-----------|-----------------|
|          |                         | PRIM.     | DROPS     |             |           |                 |
| 380010A  | 100W                    | 12/3 S00W | 14/3 S00W | 115'        | A21       | 10              |
| 380310A  | 100W                    | 12/3 S00W | 14/3 S00W | 45'         | A21       | 3               |
| 380510A  | 100W                    | 12/3 S00W | 14/3 S00W | 65'         | A21       | 5               |

**Fluorescent Stringlights**

| PART NO. | FIXTURE VOLTAGE | LAMP WATTAGE | CORD TYPE | CORD LENGTH | LAMP TYPE     | REPLAC. LAMP | NUMBER OF DROPS |
|----------|-----------------|--------------|-----------|-------------|---------------|--------------|-----------------|
| 387010A  | 120V/60HZ       | 26W          | 12/3 S00W | 115'        | PL-C 26/41/4P | 34-0391      | 10              |
| 387510A  | 120V/60HZ       | 26W          | 12/3 S00W | 65'         | PL-C 26/41/4P | 34-0391      | 5               |

UL SP MOST WOODHEAD PRODUCTS HAVE U.L. AND/OR CSA APPROVALS. FOR A LISTING OF APPROVALS BY PART NUMBER, SEE PAGES 262-269.



## TEMPORARY LIGHTING Industrial Duty, Incandescent, 100W, 200W

Ideal for lighting large areas, incandescent stringlights are constructed for rugged, reliable service in a wide range of industrial settings. Easy-to-replace parts assure quick, convenient serviceability. Heavy-duty #10 gauge zinc-plated guards protect bulbs and electrical components. Offered in 10-, 12-, and 14-gauge cord to meet electrical current.

### BEST SELLERS!

#### Rubber Molded Stringlight

- 100' cord
- 200W max. lamp
- 1¼" neck diameter

part no. 323123



#### Assembled Stringlight

- 362 guard
- 100' cord
- 200W max. lamp

part no. 310123

### Incandescent Stringlights

| PART NO.            | DESCRIPTION   | MAX. LAMP WATTAGE | GUARD INCLUDED | CORD TYPE | NEMA CONFIGURATION   | CORD LENGTH |
|---------------------|---------------|-------------------|----------------|-----------|----------------------|-------------|
| 323123              | RUBBER MOLDED | 200W              | —              | 12/3 SOOW | NEMA 5-15            | 100'        |
| 323523              | RUBBER MOLDED | 200W              | —              | 12/3 SOOW | NEMA 5-15            | 50'         |
| 323126              | RUBBER MOLDED | 200W              | 377            | 12/3 SOOW | NEMA 5-15            | 100'        |
| 323526              | RUBBER MOLDED | 200W              | 377            | 12/3 SOOW | NEMA 5-15            | 50'         |
| 323124              | RUBBER MOLDED | 200W              | —              | 12/3 SOOW | NEMA 5-20            | 100'        |
| 323524              | RUBBER MOLDED | 200W              | —              | 12/3 SOOW | NEMA 5-20            | 50'         |
| 323125              | RUBBER MOLDED | 200W              | 377            | 12/3 SOOW | NEMA 5-20            | 100'        |
| 323525              | RUBBER MOLDED | 200W              | 377            | 12/3 SOOW | NEMA 5-20            | 50'         |
| 323133              | RUBBER MOLDED | 200W              | —              | 12/3 SOOW | NEMA L5-15           | 100'        |
| 323533              | RUBBER MOLDED | 200W              | —              | 12/3 SOOW | NEMA L5-15           | 50'         |
| 323134              | RUBBER MOLDED | 200W              | —              | 12/3 SOOW | NEMA L5-20           | 100'        |
| 323534              | RUBBER MOLDED | 200W              | —              | 12/3 SOOW | NEMA L5-20           | 50'         |
| 323135              | RUBBER MOLDED | 200W              | 377            | 12/3 SOOW | NEMA L5-20           | 100'        |
| 323535              | RUBBER MOLDED | 200W              | 377            | 12/3 SOOW | NEMA L5-20           | 50'         |
| 320122              | RUBBER MOLDED | 200W              | —              | 12/2 SOOW | NEMA 1-15            | 100'        |
| 320522              | RUBBER MOLDED | 200W              | —              | 12/2 SOOW | NEMA 1-15            | 50'         |
| 321637 <sup>1</sup> | RUBBER MOLDED | 100W              | —              | 10/3 SOOW | 30A NON-NEMA LOCKING | 50'         |
| 310123              | ASSEMBLED     | 200W              | 362            | 12/3 SOOW | NEMA 5-15            | 100'        |
| 310143              | ASSEMBLED     | 200W              | 362            | 14/3 SOOW | NEMA 5-15            | 100'        |
| 310223              | ASSEMBLED     | 200W              | 362            | 12/3 SOOW | NEMA L5-15           | 100'        |
| 310243              | ASSEMBLED     | 200W              | 362            | 14/3 SOOW | NEMA L5-15           | 100'        |
| 310323              | ASSEMBLED     | 200W              | 362            | 12/3 SOOW | NEMA 5-20            | 100'        |
| 310423              | ASSEMBLED     | 200W              | 362            | 12/3 SOOW | NEMA L5-20           | 100'        |

<sup>1</sup> FOR USE WITH LOW VOLTAGE WORKSTATION ON PAGE 13



MOST WOODHEAD PRODUCTS HAVE U.L. AND/OR CSA APPROVALS.  
FOR A LISTING OF APPROVALS BY PART NUMBER, SEE PAGES 262-269.

**GUARDS** Industrial Duty, Incandescent, Temporary Lighting — Molded

Complete guard family for use with Super-Safeway® Molded Stringlights which feature 1¼" neck diameters.



**Stringlight Guards**

| PART NO. | LAMP DESCRIPTION                      | VINYL COATED | TYPE       |
|----------|---------------------------------------|--------------|------------|
| 370      | METAL WIRE – BOTTOM COVER             |              | —          |
| 372      | METAL WIRE                            |              | A23        |
| 372V     | METAL WIRE                            | ●            | A23        |
| 377      | METAL WIRE                            |              | A19, A21   |
| 377V     | METAL WIRE                            | ●            | A19, A21   |
| 378      | METAL WIRE                            |              | PS25, PS30 |
| 378V     | METAL WIRE                            | ●            | PS25, PS30 |
| 381R     | CLEAR POLYCARBONATE                   |              | A19, A21   |
| 383      | CLEAR POLYCARBONATE WITH BOTTOM COVER |              | A19, A21   |
| 385      | CLEAR POLYCARBONATE – BOTTOM COVER    |              | —          |

**Lamp Holders** For assembled molded stringlights.

| PART NO. | DESCRIPTION                                      | MAX. LAMP WATTAGE | GUARD INCLUDED |
|----------|--|-------------------|----------------|
| 300      | LAMP HOLDER WITH SCREW CLAMP CORD GRIP           | 200W              | —              |
| 301      | T-SPICE  | —                 | —              |
| 302U     | LAMP HOLDER WITH THREE WIRE NEMA 5-15 RECEPTACLE | —                 | —              |
| 300W     | LAMP HOLDER WITH WEATHER RESISTANT CORD GRIP     | 200W              | —              |
| 310W     | LAMP HOLDER WITH WEATHER RESISTANT CORD GRIP     | 200W              | 362            |
| 310      | LAMP HOLDER WITH SCREW CLAMP CORD GRIP           | 200W              | 362            |

**Replacement Parts**

| PART NO. | DESCRIPTION                                 |
|----------|---|
| 305      | SUPER-SAFEWAY LAMP HOLDER COVER (300 & 310) |
| 306      | SUPER-SAFEWAY HOUSING (300 & 310)           |
| 355      | S HOOK                                      |

 MOST WOODHEAD PRODUCTS HAVE U.L. AND/OR CSA APPROVALS. FOR A LISTING OF APPROVALS BY PART NUMBER, SEE PAGES 262-269.





## TEMPORARY LIGHTING Commercial Duty, Incandescent, 200W

Safety Yellow® stringlights give you unbeatable value for contractor duty performance that stands up to hard usage. Woodhead Safety Yellow® stringlights provide you with job-tough reliability and NEC and OSHA compliance at an affordable price.

### BEST SELLERS!

#### Molded Stringlight

- 100' cord length
- 10 sockets
- guards included

part no. 5000



## Incandescent Stringlights For guards, see page 37.

| PART NO. | MAXIMUM WATTAGE | CORD TYPE | CORD LENGTH | NUMBER OF SOCKETS | THIRD PARTY APPROVAL | GUARDS |
|----------|-----------------|-----------|-------------|-------------------|----------------------|--------|
| 5000     | 200W            | 14/2 SJTW | 100'        | 10                | UL                   | ●      |
| 5001     | 200W            | 14/2 SJTW | 50'         | 5                 | UL                   | ●      |
| 5002     | 200W            | 12/3 SJTW | 100'        | 10                | UL                   | ●      |
| 5003     | 200W            | 12/3 SJTW | 50'         | 5                 | UL                   | ●      |
| 5006     | 200W            | 12/2 STW  | 100'        | 10                | CSA                  | ●      |
| 5007     | 200W            | 12/2 STW  | 50'         | 5                 | CSA                  | ●      |
| 5008     | 200W            | 12/3 STW  | 100'        | 10                | CSA                  | ●      |
| 5009     | 200W            | 12/3 STW  | 50'         | 5                 | CSA                  | ●      |



#### Molded Stringlight without Guards

- 100' cord length
- 10 sockets
- 1½" neck diameter

part no. 5002

MOST WOODHEAD PRODUCTS HAVE U.L. AND/OR CSA APPROVALS. FOR A LISTING OF APPROVALS BY PART NUMBER, SEE PAGES 262-269.



## TEMPORARY LIGHTING General Duty, Incandescent, 150W

Pro-Yellow® stringlights give you unbeatable value for standard duty performance that stands up to hard usage. Woodhead Pro-Yellow® stringlights provide you with job-tough reliability and NEC and OSHA compliance at an affordable price.

### BEST SELLERS!

#### Pro-Yellow® Stringlight

- cord type 12/2 TC
- 100' cord length

part no. 302SRL

#### Pro-Yellow® Stringlight

- same as above, and CSA approved

part no. 302SRLCA

#### Replacement Lamp Guard

- A19, A21 lamp type

part no. STR101



### Stringlights

| PART NO. | DESCRIPTION                 | MAX. LAMP WATTAGE | CORD TYPE   | CORD LENGTH | NUMBER OF SOCKETS |
|----------|-----------------------------|-------------------|-------------|-------------|-------------------|
| 202SRL   | PRO-YELLOW® – UL LISTED     | 150W              | 14/2        | 100'        | 10                |
| 302SRL   | PRO-YELLOW® – UL LISTED     | 150W              | 12/2 TC     | 100'        | 10                |
| 302SRLCA | PRO-YELLOW® – CSA APPROVED  | 150W              | 12/2 TC     | 100'        | 10                |
| STR100   | LITE-A-SITE® OPEN CONDUCTOR | 100W              | 14 GA. THHN | 100'        | 10                |

### Accessories

| PART NO. | DESCRIPTION                                 |
|----------|---|
| STR101   | PRO-YELLOW® YELLOW POLYCARBONATE GUARD      |
| STR102   | GUY WIRE ASSEMBLY                           |
| STR104   | LITE-A-SITE® OPEN CONDUCTOR SOCKET ASSEMBLY |



MOST WOODHEAD PRODUCTS HAVE U.L. AND/OR CSA APPROVALS. FOR A LISTING OF APPROVALS BY PART NUMBER, SEE PAGES 262-269.

## PORTABLE LIGHTING

### GUARDS Commercial Duty, Incandescent, Temporary Lighting — 5000 Series and Assembled

Complete guard family for use with 5000 Series Safety Yellow® Stringlights or assembled Stringlight sockets (see page 38) that feature 1½" diameter necks.

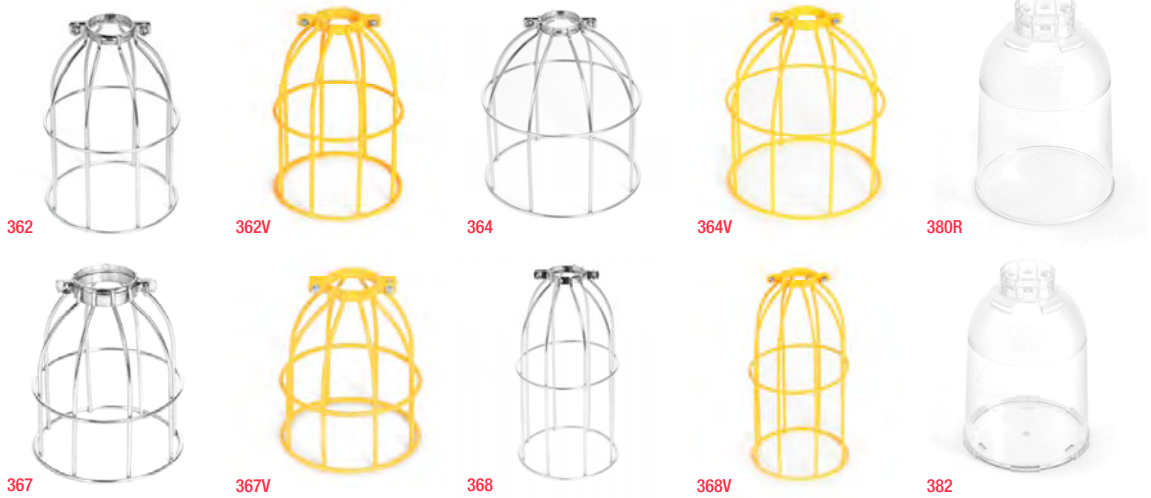

### Safety Yellow® Stringlight Guards

| PART NO. | DESCRIPTION                                 | VINYL COATED | LAMP TYPE  |
|----------|---|--------------|------------|
| 362      | METAL WIRE GUARD                            |              | A23        |
| 362V     | METAL WIRE GUARD                            | ●            | A23        |
| 364      | METAL WIRE GUARD                            |              | PAR38, R40 |
| 364V     | METAL WIRE GUARD                            | ●            | PAR38, R40 |
| 367      | METAL WIRE GUARD                            |              | A19, A21   |
| 367V     | METAL WIRE GUARD                            | ●            | A19, A21   |
| 368      | METAL WIRE GUARD                            |              | PS25, PS30 |
| 368V     | METAL WIRE GUARD                            | ●            | PS25, PS30 |
| 380R     | CLEAR POLYCARBONATE GUARD                   |              | A19, A21   |
| 382      | CLEAR POLYCARBONATE GUARD WITH BOTTOM COVER |              | A19, A21   |



MOST WOODHEAD PRODUCTS HAVE U.L. AND/OR CSA APPROVALS.  
FOR A LISTING OF APPROVALS BY PART NUMBER, SEE PAGES 262-269.



## SPOTLIGHTS AND FLOODLIGHTS Wet Location, Low Voltage, 30W, 35W, 60W, 100W

Woodhead wet-location lights and associated devices are exceptionally durable, easy to handle and service, and capable of long, continuous operation in some of industry's most demanding environments. Spotlights and floodlights for both 120V and 12V usage shows Woodhead's commitment to the right products for the right environments, whatever they may be.

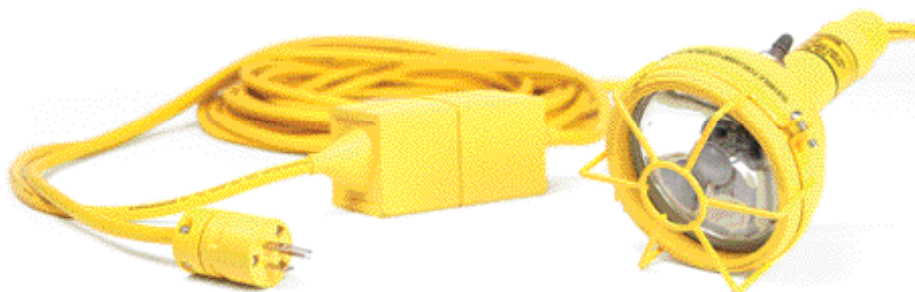

### BEST SELLERS!

#### 30W Spotlight

- 5-15 NEMA plug
- on/off switch in handle
- 50,000 candle power
- lamp type PAR 36
- 6° x 5° beam spread
- 50' 14/2 SOOW secondary cord

part no. 1610S (shown)

#### 30W Spotlight

- same as above, but without switch

part no. 1610

### Spotlights All lamp types are PAR 36.

| PART NO.             | SWITCH | FIXTURE VOLTAGE |       | LAMP WATTAGE | CANDLE POWER | BEAM SPREAD | CORD TYPE   |            | NEMA CONFIG. | REPL. LAMP | TRANSFORMER TYPE |
|----------------------|--------|-----------------|-------|--------------|--------------|-------------|-------------|------------|--------------|------------|------------------|
|                      |        | PRIM.           | SEC.  |              |              |             | PRIM. (10') | SEC. (50') |              |            |                  |
| 1610S                | ●      | 120V/60HZ       | 12VAC | 30W          | 50000        | 6° X 5°     | 16/3 SOOW   | 14/2 SOOW  | NEMA 5-15    | 34-2120    | IN-LINE          |
| 1610                 |        | 120V/60HZ       | 12VAC | 30W          | 50000        | 6° X 5°     | 16/3 SOOW   | 14/2 SOOW  | NEMA 5-15    | 34-2120    | IN-LINE          |
| 1606                 |        | 12VAC/DC        | —     | 30W          | 50000        | 6° X 5°     | —           | 16/2 SOOW  | —            | 34-2120    | BATT. CLIPS      |
| 1647-12 <sup>1</sup> |        | 12VAC/DC        | —     | 30W          | 50000        | 6° X 5°     | —           | 14/2 SOOW  | NON-NEMA     | 34-2120    | WORKSTATION      |
| 1684S                | ●      | 220V/60HZ       | 12VAC | 30W          | 50000        | 6° X 5°     | 16/3 SOOW   | 14/2 SOOW  | NEMA 6-15    | 34-2120    | IN-LINE          |
| 1684                 |        | 220V/60HZ       | 12VAC | 30W          | 50000        | 6° X 5°     | 16/3 SOOW   | 14/2 SOOW  | NEMA 6-15    | 34-2120    | IN-LINE          |
| 1691-12BS            | ●      | 120V/60HZ       | 12VAC | 100W         | 60000        | 14° X 6°    | 16/3 SOOW   | 14/2 SOOW  | NEMA 5-15    | 34-0210    | IN-LINE          |
| 1691-12 <sup>1</sup> |        | 12VAC/DC        | —     | 100W         | 60000        | 14° X 6°    | —           | 14/2 SOOW  | NON-NEMA     | 34-0210    | WORKSTATION      |
| 1691-12B             |        | 120V/60HZ       | 12VAC | 100W         | 60000        | 14° X 6°    | 16/3 SOOW   | 14/2 SOOW  | NEMA 5-15    | 34-0210    | IN-LINE          |

<sup>1</sup> FOR USE WITH LOW VOLTAGE WORKSTATION ON PAGE 13

### Floodlights All lamp types are PAR 36.

| PART NO.             | SWITCH | FIXTURE VOLTAGE |       | LAMP WATTAGE | BEAM SPREAD | CORD TYPE   |            | NEMA CONFIG. | REPL. LAMP | TRANSFORMER TYPE |
|----------------------|--------|-----------------|-------|--------------|-------------|-------------|------------|--------------|------------|------------------|
|                      |        | PRIM.           | SEC.  |              |             | PRIM. (10') | SEC. (50') |              |            |                  |
| 1612S                | ●      | 120V/60HZ       | 12VAC | 35W          | 110°        | 16/3 SOOW   | 14/2 SOOW  | NEMA 5-15    | 34-2840    | IN-LINE          |
| 1612                 |        | 120V/60HZ       | 12VAC | 35W          | 110°        | 16/3 SOOW   | 14/2 SOOW  | NEMA 5-15    | 34-2840    | IN-LINE          |
| 1639-12 <sup>1</sup> |        | 12VAC/DC        | —     | 35W          | 110°        | —           | 14/2 SOOW  | NON-NEMA     | 34-2840    | WORKSTATION      |
| 1682S                | ●      | 220V/60HZ       | 12VAC | 35W          | 110°        | 16/3 SOOW   | 14/2 SOOW  | NEMA 6-15    | 34-2840    | IN-LINE          |
| 1682                 |        | 220V/60HZ       | 12VAC | 35W          | 110°        | 16/3 SOOW   | 14/2 SOOW  | NEMA 6-15    | 34-2840    | IN-LINE          |
| 1692-12BS            | ●      | 120V/60HZ       | 12VAC | 60W          | 110°        | 16/3 SOOW   | 14/2 SOOW  | NEMA 5-15    | 34-0380    | IN-LINE          |
| 1692-12B             |        | 120V/60HZ       | 12VAC | 60W          | 110°        | 16/3 SOOW   | 14/2 SOOW  | NEMA 5-15    | 34-0380    | IN-LINE          |
| 1638-12 <sup>1</sup> |        | 12VAC/DC        | —     | 60W          | 110°        | —           | 14/2 SOOW  | NON-NEMA     | 34-0380    | WORKSTATION      |

<sup>1</sup> FOR USE WITH LOW VOLTAGE WORKSTATION ON PAGE 13

### Replacement Parts and Lamps

| PART NO. | DESCRIPTION   | PART NO. | DESCRIPTION   |
|----------|---|----------|---|
| 00-4140  | IN-LINE TRANSFORMER COVER FOR LOW VOLTAGE SPOTLIGHTS & FLOODLIGHTS – RIGHT HALF | 1675-12  | IN-LINE TRANSFORMER FOR 60W FLOODLIGHT (120V-12V)             |
| 00-4180  | IN-LINE TRANSFORMER COVER FOR LOW VOLTAGE SPOTLIGHTS & FLOODLIGHTS – LEFT HALF  | 1676     | IN-LINE TRANSFORMER COVER FOR 60W FLOODLIGHT & 100W SPOTLIGHT |
| 1653-12  | IN-LINE TRANSFORMER FOR 35W FLOODLIGHT (120V-12V)                               | 1677     | IN-LINE TRANSFORMER REPLACEMENT HANDLE                        |
| 1660     | HANDLE ASSEMBLY WITH GUARD FOR SPOTLIGHT & FLOODLIGHT                           | 34-0210  | 100W 12V PAR36 SPOT LAMP (LOW VOLT)                           |
| 1660S    | HANDLE ASSEMBLY WITH GUARD FOR SPOTLIGHT & FLOODLIGHT WITH SWITCH               | 34-0380  | 60W 12V PAR36 FLOOD LAMP (LOW VOLT)                           |
| 1668     | GUARD FOR SPOTLIGHT & FLOODLIGHT  | 34-2120  | 30W 12V PAR36 SPOT LAMP (LOW VOLT)                            |
|          |   | 34-2840  | 35W 12V PAR36 FLOOD LAMP (LOW VOLT)                           |

# PORTABLE LIGHTING

## MACHINE LIGHTS Incandescent & Fluorescent, 13W, 20W, 26W, 27W, 40W, 60W

Machine tool lights available in three styles (fluorescent, halogen spotlight and incandescent), provide bright, safe illumination in harsh and abusive environments – both fixed and temporary. Realizing that every application is different, Woodhead offers various mounting options. Choose from flexible neck, screw mounting or magnet mounting to fit your needs.

### BEST SELLERS!

#### Fluorescent Machine Light

- magnet mount
- 13W

part no. 1083-3MM

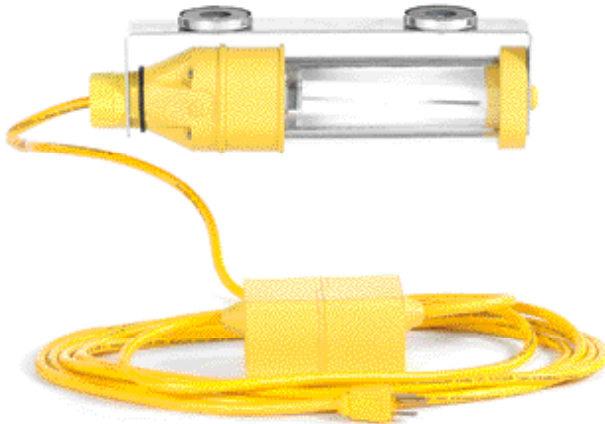

#### Fluorescent Machine Light

- same as 1083-3MM, with flexible neck

part no. 8550M



#### Machine Light with Flexible Neck

- magnet mount
- 60W incandescent A19

part no. 8530M



#### Machine Light with Flexible Neck

- same as above, with 20W halogen spotlight

part no. 8540M

## Machine Lights

| PART NO.            | DESC.   | MOUNT TYPE | FIXTURE VOLTAGE | LAMP WATT. | CORD TYPE   | NEMA CONFIGURATION       | CORD LENGTH | LAMP TYPE     | REPLACEMENT LAMP |
|---------------------|---------|------------|-----------------|------------|-------------|--------------------------|-------------|---------------|------------------|
| 1083-3MM            | FLUOR.  | MAGNET     | 120V/60HZ       | 13W        | 18/3 SJTOOW | SUPER-SAFEWAY® NEMA 5-15 | 15'         | PL13/41       | 34-0390          |
| 1083-3M             | FLUOR.  | SCREW      | 120V/60HZ       | 13W        | 18/3 SJTOOW | SUPER-SAFEWAY NEMA 5-15  | 15'         | PL13/41       | 34-0390          |
| 1083-3MM-24         | FLUOR.  | MAGNET     | 24 DC           | 13W        | 18/3 SJTOOW | —                        | 15'         | PL13/41       | 34-0390          |
| 1083-3M-P           | FLUOR.  | SCREW      | 230V/50HZ       | 13W        | 18/3 SJTOOW | —                        | 25'         | PL13/41       | 34-0390          |
| 1093-3MM            | FLUOR.  | MAGNET     | 120V/60HZ       | 27W        | 18/3 SJTOOW | SUPER-SAFEWAY NEMA 5-15  | 15'         | PL-L 27/41    | 34-0130          |
| 1093-3M             | FLUOR.  | SCREW      | 120V/60HZ       | 27W        | 18/3 SJTOOW | SUPER-SAFEWAY NEMA 5-15  | 15'         | PL-L 27/41    | 34-0130          |
| 1097-3MM            | FLUOR.  | MAGNET     | 120V/60HZ       | 40W        | 18/3 SJTOOW | SUPER-SAFEWAY NEMA 5-15  | 15'         | PL-L 40/41    | 34-0120          |
| 1097-3M             | FLUOR.  | SCREW      | 120V/60HZ       | 40W        | 18/3 SJTOOW | SUPER-SAFEWAY NEMA 5-15  | 15'         | PL-L 40/41    | 34-0120          |
| 8530M <sup>1</sup>  | INCAND. | MAGNET     | 120VAC          | 60W        | 18/2 SJTOW  | NEMA 1-15                | 10'         | A19           | —                |
| 8530P <sup>1</sup>  | INCAND. | SCREW      | 120VAC          | 60W        | 18/2 SJTOW  | NEMA 1-15                | 10'         | A19           | —                |
| 8540M <sup>1</sup>  | HALGN.  | MAGNET     | 120VAC          | 20W        | 18/3 SJTO   | NEMA 5-15                | 10'         | —             | —                |
| 8540P <sup>1</sup>  | HALGN.  | SCREW      | 120VAC          | 20W        | 18/3 SJTO   | NEMA 5-15                | 10'         | —             | —                |
| 8550M <sup>1</sup>  | FLUOR.  | MAGNET     | 120VAC          | 13W        | 18/3 SJTO   | NEMA 5-15                | 10'         | PL13/41       | 34-0390          |
| 8550P <sup>1</sup>  | FLUOR.  | SCREW      | 120VAC          | 13W        | 18/3 SJTO   | NEMA 5-15                | 10'         | PL13/41       | 34-0390          |
| 2113S               | FLUOR.  | SCREW      | 120V/60HZ       | 13W        | 16/3 SJTOOW | WATERTITE® NEMA 5-15     | 15'         | PL13/41       | 34-0390          |
| 2113MS              | FLUOR.  | MAGNET     | 120V/60HZ       | 13W        | 16/3 SJTOOW | WATERTITE® NEMA 5-15     | 15'         | PL13/41       | 34-0390          |
| 2113GS <sup>2</sup> | FLUOR.  | SCREW      | 120V/60HZ       | 13W        | 16/3 SJTOOW | WATERTITE® NEMA 5-15     | 15'         | PL13/41       | 34-0390          |
| 2126S               | FLUOR.  | SCREW      | 120V/60HZ       | 26W        | 16/3 SJTOOW | WATERTITE® NEMA 5-15     | 15'         | PL-C 26/41/4P | 34-0391          |
| 2126MS              | FLUOR.  | MAGNET     | 120V/60HZ       | 26W        | 16/3 SJTOOW | WATERTITE® NEMA 5-15     | 15'         | PL-C 26/41/4P | 34-0391          |
| 2126GS <sup>2</sup> | FLUOR.  | SCREW      | 120V/60HZ       | 26W        | 16/3 SJTOOW | WATERTITE® NEMA 5-15     | 15'         | PL-C 26/41/4P | 34-0391          |

<sup>1</sup> FLEXIBLE NECK

<sup>2</sup> GLASS LAMP SHIELD



MOST WOODHEAD PRODUCTS HAVE U.L. AND/OR CSA APPROVALS. FOR A LISTING OF APPROVALS BY PART NUMBER, SEE PAGES 262-269.

## Replacement Parts

| PART NO. | DESCRIPTION   |
|----------|---|
| 36-2083  | GLASS SHIELD ASSEMBLY FOR 2113 AND 2123 SERIES MACHINE LIGHTS |
| 40-1043  | SHIELD ASSEMBLY FOR 1083-3M 13W FLUORESCENT MACHINES LIGHTS   |

LIGHTING AND ACCESSORIES

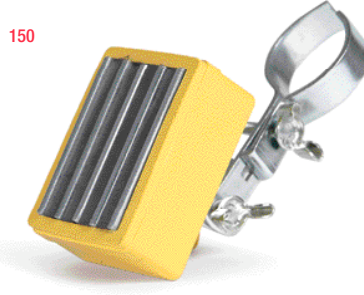

Lighting Accessories

| PART NO. | DESCRIPTION  | FIXTURE VOLTAGE | LAMP WATTAGE | CORD TYPE  | NEMA CONFIG. | CORD LENGTH | LAMP TYPE |
|----------|--|-----------------|--------------|------------|--------------|-------------|-----------|
| 393E123  | SUPER-SAFEWAY® 3 WIRE MOLDED T-SPLICE WITH THREE 1' LEGS | —               | —            | 12/3 S00W  | —            | —           | —         |
| 393E143  | SUPER-SAFEWAY 3 WIRE MOLDED T-SPLICE WITH THREE 1' LEGS  | —               | —            | 14/3 S00W  | —            | —           | —         |
| 611      | SAFEWAY INCANDESCENT SERVICE LIGHT                       | 120V/60HZ       | 7            | 18/2 SPT-1 | NEMA 1-15    | 10'         | 7C7       |
| 150      | MAGNETIC HOLDER BASE WITH SWIVEL                         | —               | —            | —          | —            | —           | —         |

Hand Lamps

| PART NO. | OUTLET | FIXTURE SWITCH | MAX. LAMP VOLTAGE | LAMP WATTAGE | NEMA CONFIG. | CORD TYPE  | LENGTH |
|----------|--------|----------------|-------------------|--------------|--------------|------------|--------|
| 402      | ●      | ●              | 120VAC            | 100          | NEMA 5-15    | 16/3 SJTOW | 25'    |
| 405      | ●      | ●              | 120VAC            | 100          | NEMA 5-15    | 16/3 SJTOW | 50'    |

Watertite® Pigtail Sockets & Lampholders

NEōTEX® rubber cover construction with water-resistant lip that molds around bulb to form a water-resistant seal. Ceramic base interior with full-thread copper screw shell, medium base, #14 gauge wire leads, 600V 300 watt, maximum 15A. Can be fitted with 1.5" diameter neck guards on page 37.

| PART NO. | DESCRIPTION   |
|----------|---|
| 600      | SOCKET WITH 4-1/2" LEADS                                      |
| 600SC    | SOCKET WITH SPRING CONTACT                                    |
| 601      | SOCKET WITH 3-1/4" COVER                                      |
| 602      | SOCKET WITH 4" COVER  |
| 603      | LAMPHOLDER 4-1/2" LEADS                                       |
| 606      | "TURTLE-NEK" SOCKET WITH MOUNTING FLANGE FOR 3.5" OR 4" BOXES |
| 1262     | 4-1/2" LEADS (WITHOUT WATERTITE® LIP)                         |



UL SP MOST WOODHEAD PRODUCTS HAVE U.L. AND/OR CSA APPROVALS. FOR A LISTING OF APPROVALS BY PART NUMBER, SEE PAGES 262-269.



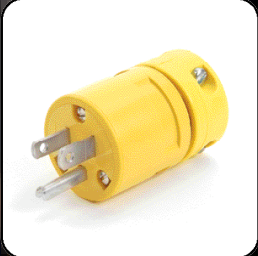

Want the facts about wiring devices? Talk to experts who work in some of the toughest manufacturing environments imaginable. Ask MRO managers who are responsible for keeping sensitive electronic equipment up and running in wet or corrosive conditions. Consult with construction engineers, who demand wiring devices that consistently stand up to abuse on the job. Inquire at hospitals, where an added margin of safety is absolutely critical. Time and time again, the professionals will tell you who they count on for durability and performance – Woodhead.

### **Watertite® Wiring Devices**

The industry standard for reliable protection in wet and abusive environments. When conditions demand reliable, moisture-resistant performance, U.L. listed and tested Watertite® plugs and connectors offer the ultimate solution. Our patented multiple seal and rugged NEōTEX® Paracril OZO rubber construction can withstand up to 1000 psi of hosedown, and provides a tight barrier against oil, water, dust and other contaminants.

When properly mated, Watertite® devices form an enclosure that meets the requirements of NEMA type 1, 3, 4, 4X, 5, 6, 6P, and 12 – as well as IP55, IP56, IP57, IP65, IP66, and IP67. No other company offers a rubber wiring device that meets so many U.L. tested ratings for wet locations.

### **Super-Safeway® Wiring Devices**

















































Built to endure rigorous industrial conditions. With their tough NEōTEX Paracril OZO rubber housing, Super-Safeway® plugs and connectors perform more reliably under rugged conditions than devices formed of ETPR thermoplastic. They are the ideal solution for applications where continuous impact and abrasion are an everyday occurrence. For dependability in settings where the protection of a Watertite® device is not required, Super-Safeway® wiring devices are the answer.

### **Safeway+® Wiring Devices**

Performance engineered for general purpose applications. With their hard nylon core and protective rubber coating, Safeway+® wiring devices provide exceptional performance. The product's unique 3-piece assembly locks together with just two screws, while the patented reversible cord clamp eliminates the need for cord spacers. For general purpose use at an economical price, Woodhead's Safeway+® wiring devices outperform all other products in their class.

















































# WIRING DEVICES

## KEY PRODUCT SELECTOR GUIDE

| NEMA CONFIGURATION  | VOLTAGE/ AMPERAGE    | PAGE    | WATERTITE®                  |           |                                      |                                      |                                    |                               |  |
|---|----------------------|---------|-----------------------------|-----------|--------------------------------------|--------------------------------------|------------------------------------|-------------------------------|--|
|   |                      |         | PLUG                        | CONNECTOR | SINGLE FLIP LID w/ FEMALE RECEPTACLE | DUPLEX FLIP LID w/ FEMALE RECEPTACLE | SINGLE FLIP LID w/ MALE RECEPTACLE | CONNECTOR FOR MALE RECEPTACLE |  |
| <b>2-POLE/2-WIRE</b>  |                      |         |                             |           |                                      |                                      |                                    |                               |  |
| 1-15                   | 15A/125V             | 48-51   | 14W04<br>14W19 <sup>1</sup> | 15W04     | 60W04                                | 60W04DPLX                            | 59W04                              | 15W04MB                       |  |
| L1-15                  | 15A/125V             | 48-51   | 24W04                       | 25W04     | 65W04                                | 65W04DPLX                            | 64W04                              | 25W04MB                       |  |
| L2-20                  | 20A/250V             | 68-71   | 26W07                       | 27W07     | 67W07                                | 67W07DPLX                            | 66W07                              | 27W07MB                       |  |
| <b>2-POLE/3-WIRE</b>  |                      |         |                             |           |                                      |                                      |                                    |                               |  |
| 5-15                   | 15A/125V             | 52-59   | 14W47                       | 15W47     | 60W47                                | 60W47DPLX                            | 59W47                              | 15W47MB                       |  |
| L5-15                  | 15A/125V             | 52-59   | 24W47                       | 25W47     | 65W47                                | 65W47DPLX                            | 64W47                              | 25W47MB                       |  |
| 6-15                   | 15A/250V             | 60-63   | 14W49                       | 15W49     | 60W49                                | 60W49DPLX                            | 59W49                              | 15W49MB                       |  |
| L6-15                  | 15A/250V             | 60-63   | 24W49                       | 25W49     | 65W49                                | 65W49DPLX                            | 64W49                              | 25W49MB                       |  |
| 7-15                   | 15A/277V             | 60-63   | 14W34                       | 15W34     | 60W34                                | 60W34DPLX                            | 59W34                              | 15W34MB                       |  |
| L7-15                  | 15A/277V             | 60-63   | 24W34                       | 25W34     | 65W34                                | 65W34DPLX                            | 64W34                              | 25W34MB                       |  |
| 5-20                   | 20A/125V             | 72-79   | 14W33                       | 15W33     | 60W33                                | 60W33DPLX                            | 59W33                              | 15W33MB                       |  |
| L5-20                  | 20A/125V             | 72-79   | 26W47                       | 27W47     | 67W47                                | —                                    | 66W47                              | 27W47MB                       |  |
| 6-20                   | 20A/250V             | 84-87   | 14W48                       | 15W48     | 60W48                                | 60W48DPLX                            | 59W48                              | 15W48MB                       |  |
| L6-20                  | 20A/250V             | 84-87   | 26W48                       | 27W48     | 67W48                                | —                                    | 66W48                              | 27W48MB                       |  |
| L7-20                  | 20A/277V             | 84-87   | 26W49                       | 27W49     | 67W49                                | —                                    | 66W49                              | 27W49MB                       |  |
| L5-30                  | 30A/125V             | 96-99   | 28W47                       | 29W47     | 69W47                                | —                                    | 68W47                              | 29W47MB                       |  |
| L6-30                  | 30A/250V             | 96-99   | 28W48                       | 29W48     | 69W48                                | —                                    | 68W48                              | 29W48MB                       |  |
| L7-30                  | 30A/277V             | 96-99   | 28W49                       | 29W49     | 69W49                                | —                                    | 68W49                              | 29W49MB                       |  |
| 6-50                   | 50A/250V             | 112     | —                           | —         | —                                    | —                                    | —                                  | —                             |  |
| Non-NEMA Locking CA    | 50A/125V             | 112     | CS63W61                     | CS63W60   | CS69W60                              | —                                    | —                                  | —                             |  |
| Non-NEMA Locking       | 50A/125V             | 112     | 63W61                       | 63W60     | 69W60                                | —                                    | —                                  | —                             |  |
| Non-NEMA Locking CA    | 50A/250V             | 112     | CS82W65                     | CS82W64   | 69W64                                | —                                    | —                                  | —                             |  |
| Non-NEMA Locking       | 50A/600VAC/250VDC    | 112     | 37W63                       | 37W62     | 69W62                                | —                                    | —                                  | —                             |  |
| Non-NEMA Locking CA    | 50A/480V             | 112     | CS84W65                     | CS84W64   | 67W64                                | —                                    | —                                  | —                             |  |
| <b>3-POLE/3-WIRE</b>  |                      |         |                             |           |                                      |                                      |                                    |                               |  |
| Non-NEMA             | 15A/125V 10A/250V    | 64-67   | 14W07                       | 60W07DPLX | 15W07                                | 60W07                                | 59W07                              | 15W07MB                       |  |
| Non-NEMA Locking     | 15A/125V 10A/250V    | 64-67   | 24W07                       | 65W07DPLX | 25W07                                | 65W07                                | 64W07                              | 25W07MB                       |  |
| Non-NEMA Locking     | 20A/125V/250V        | 80-83   | 26W08                       | 27W08     | —                                    | 67W08                                | 66W08                              | 27W08MB                       |  |
| Non-NEMA Locking     | 20A/250V GRNDING TAB | 80-83   | 26W08G                      | 27W08G    | —                                    | —                                    | —                                  | 27W08GMB                      |  |
| Non-NEMA Locking     | 30A/125V/250V        | 100-103 | 28W08                       | 29W08     | —                                    | 69W08                                | 68W08                              | 29W08MB                       |  |
| <b>3-POLE/4-WIRE</b>  |                      |         |                             |           |                                      |                                      |                                    |                               |  |
| L14-20               | 20A/125V/250V        | 88-91   | 26W74                       | 27W74     | 67W74                                | —                                    | 66W74                              | 27W74MB                       |  |
| L15-20               | 20A/250V/3ø          | 88-91   | 26W75                       | 27W75     | 67W75                                | —                                    | 66W75                              | 27W75MB                       |  |
| L16-20               | 20A/480V/3ø          | 88-91   | 26W76                       | 27W76     | 67W76                                | —                                    | 66W76                              | 27W76MB                       |  |
| L14-30               | 30A/125V/250V        | 104-107 | 28W74                       | 29W74     | 69W74                                | —                                    | 68W74                              | 29W74MB                       |  |
| L15-30               | 30A/250V/3ø          | 104-107 | 28W75                       | 29W75     | 69W75                                | —                                    | 68W75                              | 29W75MB                       |  |
| L16-30               | 30A/480V/3ø          | 104-107 | 28W76                       | 29W76     | 69W76                                | —                                    | 68W76                              | 29W76MB                       |  |
| L17-30               | 30A/600V/3ø          | 104-107 | 28W77                       | 29W77     | 69W77                                | —                                    | 68W77                              | 29W77MB                       |  |
| Non-NEMA Locking CA  | 50A/125V/250V        | 114     | CS63W65                     | CS63W64   | CS60W64                              | —                                    | —                                  | —                             |  |
| Non-NEMA Locking     | 50A/125V/250V        | 114     | 63W65                       | 63W64     | 60W64                                | —                                    | —                                  | —                             |  |
| Non-NEMA Locking CA  | 50A/250V/3ø          | 114     | CS83W65                     | CS83W64   | 65W64                                | —                                    | —                                  | —                             |  |
| Non-NEMA Locking     | 50A/600VAC/250VDC    | 114     | 37W65                       | 37W64     | 66W64                                | —                                    | —                                  | —                             |  |
| Non-NEMA Locking CA  | 50A/480V/3ø          | 114     | CS81W65                     | CS81W64   | 64W64                                | —                                    | —                                  | —                             |  |
| <b>4-POLE/4-WIRE</b>  |                      |         |                             |           |                                      |                                      |                                    |                               |  |
| Non-NEMA Locking     | 20A/120V/208V        | 80-83   | 26W09                       | 27W09     | 67W09                                | —                                    | 66W09                              | 27W09MB                       |  |
| Non-NEMA Locking     | 30A/120V/208V        | 100-103 | 28W09                       | 29W09     | 69W09                                | —                                    | 68W09                              | 29W09MB                       |  |
| <b>4-POLE/5-WIRE</b>  |                      |         |                             |           |                                      |                                      |                                    |                               |  |
| L21-20               | 20A/120V/208V/3øY    | 92-93   | 26W81                       | 27W81     | 67W81                                | —                                    | 66W81                              | 27W81MB                       |  |
| Non-NEMA Locking     | 20A/250V 10A/600V    | 80      | 26W10                       | 27W10     | 67W10                                | —                                    | 66W10                              | 27W10MB                       |  |
| L22-20               | 20A/227V/480V/3øY    | 92-95   | 26W82                       | 27W82     | 67W82                                | —                                    | 66W82                              | 27W82MB                       |  |
| L23-20               | 20A/347V/600V/3øY    | 92-95   | 26W83                       | 27W83     | 67W83                                | —                                    | 66W83                              | 27W83MB                       |  |
| L21-30               | 30A/120V/208V/3øY    | 108-111 | 28W81                       | 29W81     | 69W81                                | —                                    | 68W81                              | 29W81MB                       |  |
| L22-30               | 30A/277V/480V/3øY    | 108-111 | 28W82                       | 29W82     | 69W82                                | —                                    | 68W82                              | 29W82MB                       |  |
| L23-30               | 30A/347V/600V/3øY    | 108-111 | 28W83                       | 29W83     | 69W83                                | —                                    | 68W83                              | 29W83MB                       |  |

<sup>1</sup> POLARIZED

KEY PRODUCT SELECTOR GUIDE

| NEMA CONFIGURATION  | VOLTAGE/AMPERAGE     | PAGE    | SUPER-SAFEWAY®            |           | SAFEWAY®                  |           |               |                     |
|---|----------------------|---------|---------------------------|-----------|---------------------------|-----------|---------------|---------------------|
|   |                      |         | PLUG                      | CONNECTOR | PLUG                      | CONNECTOR | FLANGED INLET | FLANGED RECEPTACLES |
| <b>2-POLE/2-WIRE</b>  |                      |         |                           |           |                           |           |               |                     |
| 1-15                   | 15A/125V             | 49-51   | 1404<br>1419 <sup>1</sup> | 1504      | 5166<br>5176 <sup>1</sup> | 5169      | 1404MB        | 1504MB              |
| L1-15                  | 15A/125V             | 49-51   | 2404                      | 2504      | 24T04                     | 25T04     | 2404MB        | 2504MB              |
| L2-20                  | 20A/250V             | 69-71   | 2607                      | 2707      | 26T07                     | 27T07     | 2607MB        | 2707MB              |
| <b>2-POLE/3-WIRE</b>  |                      |         |                           |           |                           |           |               |                     |
| 5-15                   | 15A/125V             | 53-59   | 1447                      | 1547      | 5266                      | 5269      | 1447MB        | 1547MB              |
| L5-15                  | 15A/125V             | 53-59   | 2447                      | 2547      | 4720                      | 4729      | 2447MB        | 2547MB              |
| 6-15                   | 15A/250V             | 61-63   | 1449                      | 1549      | 5666                      | 5669      | 1449MB        | 1549MB              |
| L6-15                  | 15A/250V             | 61-63   | 2449                      | 2549      | 24T49                     | 25T49     | 2449MB        | 2549MB              |
| 7-15                   | 15A/277V             | 61-63   | 1434                      | 1534      | 5766                      | 5769      | 1434MB        | 1534MB              |
| L7-15                  | 15A/277V             | 61-63   | 2434                      | 2534      | 4770                      | 4779      | 2434MB        | 2534MB              |
| 5-20                   | 20A/125V             | 73-79   | 1433                      | 1533      | 5366                      | 5369      | 1433MB        | 1533MB              |
| L5-20                  | 20A/125V             | 73-79   | 2647                      | 2747      | 26T47                     | 27T47     | 2647MB        | 2747MB              |
| 6-20                   | 20A/250V             | 85-87   | 1448                      | 1548      | 5466                      | 5469      | 1448MB        | 1548MB              |
| L6-20                  | 20A/250V             | 85-87   | 2648                      | 2748      | 26T48                     | 27T48     | 2648MB        | 2748MB              |
| L7-20                  | 20A/277V             | 85-87   | 2649                      | 2749      | 26T49                     | 27T49     | 2649MB        | 2749MB              |
| L5-30                  | 30A/125V             | 97-99   | 2847                      | 2947      | 28T47                     | 29T47     | 2847MB        | 2947MB              |
| L6-30                  | 30A/250V             | 97-99   | 2848                      | 2948      | 28T48                     | 29T48     | 2848MB        | 2948MB              |
| L7-30                  | 30A/277V             | 97-99   | 2849                      | 2949      | 28T49                     | 29T49     | 2849MB        | 2949MB              |
| 6-50                   | 50A/250V             | 112     | 8664                      | 8665      | —                         | —         | —             | —                   |
| Non-NEMA Locking CA    | 50A/125V             | 112-113 | —                         | —         | CS6361N                   | CS6360N   | CS6377        | CS6370 <sup>2</sup> |
| Non-NEMA Locking       | 50A/125V             | 112-113 | —                         | —         | 6361CRN                   | 6360CRN   | 6377CR        | 6370CR <sup>2</sup> |
| Non-NEMA Locking CA    | 50A/250V             | 112-113 | —                         | —         | CS8265N                   | CS8264N   | CS8275        | CS8269 <sup>2</sup> |
| Non-NEMA Locking       | 50A/600VAC/250VDC    | 112-113 | —                         | —         | 3763N                     | 3762N     | 3777          | 3771 <sup>2</sup>   |
| Non-NEMA Locking CA    | 50A/480V             | 112-113 | —                         | —         | CS8465N                   | CS8464N   | CS8475        | CS8469 <sup>2</sup> |
| <b>3-POLE/3-WIRE</b>  |                      |         |                           |           |                           |           |               |                     |
| Non-NEMA               | 15A/125V 10A/250V    | 65-67   | 1407                      | 1507      | 5276                      | 1507      | 1407MB        | 1507MB              |
| Non-NEMA Locking       | 15A/125V 10A/250V    | 65-67   | 2407                      | 2507      | 4730                      | 4739      | 2407MB        | 2507MB              |
| Non-NEMA Locking       | 20A/125V/250V        | 81-83   | 2608                      | 2708      | 26T08                     | 27T08     | 2608MB        | 2708MB              |
| Non-NEMA Locking      | 20A/250V GRNDING TAB | 81-83   | 2608G                     | 2708G     | 26T08G                    | 27T08G    | —             | —                   |
| Non-NEMA Locking     | 30A/125V/250V        | 101-103 | 2808                      | 2908      | 28T08                     | 29T08     | 2808MB        | 2908MB              |
| <b>3-POLE/4-WIRE</b>  |                      |         |                           |           |                           |           |               |                     |
| L14-20               | 20A/125V/250V        | 89-91   | 2674                      | 2774      | 26T74                     | 27T74     | 2674MB        | 2774MB              |
| L15-20               | 20A/250V/3ø          | 89-91   | 2675                      | 2775      | 26T75                     | 27T75     | 2675MB        | 2775MB              |
| L16-20               | 20A/480V/3ø          | 89-91   | 2676                      | 2776      | 26T76                     | 27T76     | 2676MB        | 2776MB              |
| L14-30               | 30A/125V/250V        | 105-107 | 2874                      | 2974      | 28T74                     | 29T74     | 2874MB        | 2974MB              |
| L15-30               | 30A/250V/3ø          | 105-107 | 2875                      | 2975      | 28T75                     | 29T75     | 2875MB        | 2975MB              |
| L16-30               | 30A/480V/3ø          | 105-107 | 2876                      | 2976      | 28T76                     | 29T76     | 2876MB        | 2976MB              |
| L17-30               | 30A/600V/3ø          | 105-107 | 2877                      | 2977      | 28T77                     | 29T77     | 2877MB        | 2977MB              |
| Non-NEMA Locking CA  | 50A/125V/250V        | 114-115 | —                         | —         | CS8365N                   | CS8364N   | CS8375        | CS8369 <sup>2</sup> |
| Non-NEMA Locking     | 50A/125V/250V        | 114-115 | —                         | —         | 6365CRN                   | 6364CRN   | 6375CR        | 6369CR <sup>2</sup> |
| Non-NEMA Locking CA  | 50A/250V/3ø          | 114-115 | —                         | —         | CS8365N                   | CS8364N   | CS8375        | CS8369 <sup>2</sup> |
| Non-NEMA Locking     | 50A/600VAC/250VDC    | 114-115 | —                         | —         | 3765N                     | 3764N     | 3775          | 3769 <sup>2</sup>   |
| Non-NEMA Locking CA  | 50A/480V/3ø          | 114-115 | —                         | —         | CS8165N                   | CS8164N   | CS8175        | CS8169 <sup>2</sup> |
| <b>4-POLE/4-WIRE</b>  |                      |         |                           |           |                           |           |               |                     |
| Non-NEMA Locking     | 20A/120V/208V        | 81-83   | 2609                      | 2709      | 26T09                     | 27T09     | 2609MB        | 2709MB              |
| Non-NEMA Locking     | 30A/120V/208V        | 101-103 | 2809                      | 2909      | 28T09                     | 29T09     | 2809MB        | 2909MB              |
| <b>4-POLE/5-WIRE</b>  |                      |         |                           |           |                           |           |               |                     |
| L21-20               | 20A/120V/208V/3øY    | 93-95   | 2681                      | 2781      | 26T81                     | 27T81     | 2681MB        | 2781MB              |
| Non-NEMA Locking     | 20A/250V 10A/600V    | 81-82   | 2610                      | 2710      | 26T10                     | 27T10     | 2610MB        | 2710MB              |
| L22-20               | 20A/227V/480V/3øY    | 93-95   | 2682                      | 2782      | 24T04                     | 25T04     | 2607MB        | 2707MB              |
| L23-20               | 20A/347V/600V/3øY    | 93-95   | 2683                      | 2783      | 26T83                     | 27T83     | 2683MB        | 2783MB              |
| L21-30               | 30A/120V/208V/3øY    | 109-111 | 2881                      | 2981      | 28T81                     | 29T81     | 2881MB        | 2981MB              |
| L22-30               | 30A/277V/480V/3øY    | 109-111 | 2882                      | 2982      | 28T82                     | 29T82     | 2882MB        | 2982MB              |
| L23-30               | 30A/347V/600V/3øY    | 109-111 | 2883                      | 2983      | 28T83                     | 29T83     | 2607MB        | 2707MB              |

<sup>1</sup> POLARIZED

<sup>2</sup> SINGLE RECEPTACLES AND NOT FLANGED RECEPTACLES

## WIRING DEVICES

### 15 AMP PLUGS AND CONNECTORS

- 125V – 2-Pole, 2-Wire – NEMA 1-15 / NEMA L1-15

Watertite® devices set the standard for the roughest, wettest and most abrasive of environments. When properly mated with corresponding connectors, Watertite® devices form an enclosure that meets the requirements of NEMA Type 4, 4X, 6 and 6P, IP65, 66 and 67, and can resist high-pressure hose-down up to 1,000 psi. Additional features include: unique multiple ring seal that locks snugly, protecting against moisture and contaminants, sturdy compression-type cord grip that provides 205 lbs. of pull-out strength, and a protective closure cap that seals the connector when it is not in use. Product photos are intended to show device style only and are not intended to reflect indicated configurations.

#### Configurations

NEMA 1-15



NEMA L1-15



WATERTITE® CONNECTOR



WATERTITE® PLUG

### Watertite® Plugs and Connectors

| CONFIGURATION | VOLTAGE | LOCKING BLADE (L) | PLUG PART NO. <sup>1</sup> | CONNECTOR PART NO. <sup>1</sup> | CORD GRIP BODY SIZE <sup>2</sup> |
|---------------|---------|-------------------|----------------------------|---------------------------------|----------------------------------|
| NEMA 1-15     | 125V    |                   | 14W04/14W19 <sup>3</sup>   | 15W04                           | F2 ½"                            |
| NEMA L1-15    | 125V    | ●                 | 24W04                      | 25W04                           | F2 ½"                            |

<sup>1</sup> FOR EXTRA-HARD OUTDOOR USE, ORDER WATERTITE® DEVICES IN UV RESISTANT BLACK. ADD "BLK" TO THE END OF THE PART NUMBER.

<sup>2</sup> FOR CORD RANGES AND CORD SPECIFICATIONS, SEE PAGE 126.

<sup>3</sup> POLARIZED

WATERTITE® RECEPTACLES  
AVAILABLE (SEE PAGE 50)

PREMADE CORDSETS  
AVAILABLE (SEE PAGE 51)



MOST WOODHEAD PRODUCTS HAVE U.L. AND/OR CSA APPROVALS.  
FOR A LISTING OF APPROVALS BY PART NUMBER, SEE PAGES 262-269.

## 15 AMP PLUGS AND CONNECTORS

- 125V – 2-Pole, 2-Wire – NEMA 1-15 / NEMA L1-15

Designed for rugged industrial and commercial use, Super-Safeway® devices share some of the advanced design features of their Watertite® counterparts. Their durable rubber housing resists heat, oil, impact, and chemicals. A patented self-centering cord clamp provides superior strain-relief for a range of cable sizes while speed screws aid in quick assembly of these dead-front back-wired devices pioneered by Woodhead. Safeway® nylon plugs and connectors are Woodhead's economical solution for industrial and commercial applications. Product photos are intended to show device style only and are not intended to reflect indicated configurations.

SUPER-SAFEWAY® PLUG

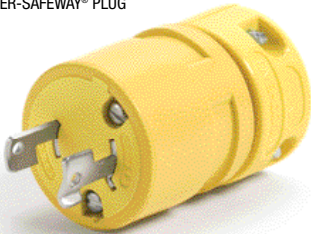

SUPER-SAFEWAY® CONNECTOR



### Super-Safeway® Plugs and Connectors

| CONFIGURATION | VOLTAGE | LOCKING BLADE (L) | PLUG PART NO. <sup>1,2</sup> | CONNECTOR PART NO. <sup>1,2</sup> |
|---------------|---------|-------------------|------------------------------|-----------------------------------|
| NEMA 1-15     | 125V    |                   | 1404/1419 <sup>3</sup>       | 1504                              |
| NEMA L1-15    | 125V    | ●                 | 2404                         | 2504                              |

SAFEWAY® PLUG



SAFEWAY® CONNECTOR



### Safeway® Plugs and Connectors<sup>4</sup>

| CONFIGURATION | VOLTAGE | LOCKING BLADE (L) | PLUG PART NO. <sup>1</sup> | CONNECTOR PART NO. <sup>1</sup> |
|---------------|---------|-------------------|----------------------------|---------------------------------|
| NEMA 1-15     | 125V    |                   | 5166/5176 <sup>3</sup>     | 5169                            |
| NEMA L1-15    | 125V    | ●                 | 24T04                      | 25T04                           |

<sup>1</sup> FOR CORD RANGES AND CORD SPECIFICATIONS, SEE PAGE 126.

<sup>2</sup> FOR EXTRA-HARD OUTDOOR USE, ORDER SUPER-SAFEWAY® IN UV RESISTANT BLACK. ADD "BLK" TO THE END OF THE PART NUMBER.

<sup>3</sup> POLARIZED

<sup>4</sup> TO ORDER SAFEWAY® DEVICE IN YELLOW ADD A "YL" SUFFIX TO THE WOODHEAD PART NO.



MOST WOODHEAD PRODUCTS HAVE U.L. AND/OR CSA APPROVALS.  
FOR A LISTING OF APPROVALS BY PART NUMBER, SEE PAGES 262-269.



## WIRING DEVICES

### 15 AMP RECEPTACLES

- 125V – 2-Pole, 2-Wire – NEMA 1-15 / NEMA L1-15

Woodhead meets your receptacle needs head-on. Single, duplex or motor-base receptacles for wet abusive environments are covered by Watertite® product solutions while general industrial applications are well served by nylon Safeway® receptacles. Watertite® receptacles feature spring-loaded flip lid covers with built-in lock-out/tag-out capabilities and the patented triple seal for the best in wet-location protection. Product photos are intended to show device style only and are not intended to reflect indicated configurations.

#### Configurations

NEMA 1-15



NEMA L1-15



WATERTITE® SINGLE FLIP LID



WATERTITE® DUPLEX FLIP LID

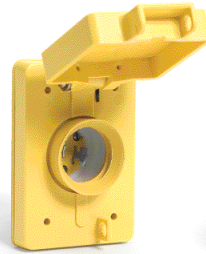

WATERTITE® FLIP LID  
W/ MALE RECEPTACLE

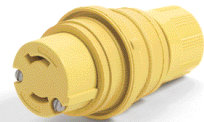

WATERTITE® CONNECTOR FOR  
FLIP LID W/ MALE RECEPTACLE

### Watertite® Receptacles with Flip Coverplates

| CONFIGURATION | VOLTAGE | LOCKING BLADE (L) | SINGLE FLIP LID | DUPLEX FLIP LID | FLIP LID WITH MALE RECEPTACLE | CONNECTOR FOR FLIP LID WITH MALE RECEPTACLE | CORD GRIP BODY SIZE |
|---------------|---------|-------------------|-----------------|-----------------|-------------------------------|---|---------------------|
| NEMA 1-15     | 125V    |                   | 60W04           | 60W04DPLX       | 59W04                         | 15W04MB                                     | F2 ½"               |
| NEMA L1-15    | 125V    | ●                 | 65W04           | 65W04DPLX       | 64W04                         | 25W04MB                                     | F2 ½"               |



SAFeway® FLANGED INLET



SAFeway® FLANGED RECEPTACLE

### Safeway® Receptacles and Inlets

| CONFIGURATION | VOLTAGE | LOCKING BLADE (L) | FLANGED INLET | FLANGED RECEPTACLE |
|---------------|---------|-------------------|---------------|--------------------|
| NEMA 1-15     | 125V    |                   | 1404MB        | 1504MB             |
| NEMA L1-15    | 125V    | ●                 | 2404MB        | 2504MB             |



MOST WOODHEAD PRODUCTS HAVE U.L. AND/OR CSA APPROVALS.  
FOR A LISTING OF APPROVALS BY PART NUMBER, SEE PAGES 262-269.

WATERTITE® PLUGS  
AND CONNECTORS  
AVAILABLE (SEE PAGE 48)

**15 AMP CORDSETS**

- 125V – 2-Pole, 2-Wire – NEMA 1-15 / NEMA L1-15

Factory pre-made Watertite® or Super-Safeway® cordsets are made from heavy-duty SOW cord and the appropriate connector bodies that fit your environment. Product photos are intended to show style only and are not intended to reflect indicated configurations.



WATERTITE® CORDSET

**Watertite® Cordsets**

| CONFIGURATION     | VOLTAGE | 16-GAUGE SOW CORDSETS | 14-GAUGE SOW CORDSETS |
|-------------------|---------|-----------------------|-----------------------|
| NEMA 1-15 (Ⓜ)(Ⓜ)  | 125V    | 14W04_162             | 14W04_142             |
| NEMA L1-15 (Ⓜ)(Ⓜ) | 125V    | 24W04_162             | 24W04_142             |

**Super-Safeway® Cordsets**

| CONFIGURATION     | VOLTAGE | 16-GAUGE SOW CORDSETS | 14-GAUGE SOW CORDSETS |
|-------------------|---------|-----------------------|-----------------------|
| NEMA 1-15 (Ⓜ)(Ⓜ)  | 125V    | 1404_162              | 1404_142              |
| NEMA L1-15 (Ⓜ)(Ⓜ) | 125V    | 2404_162              | 2404_142              |

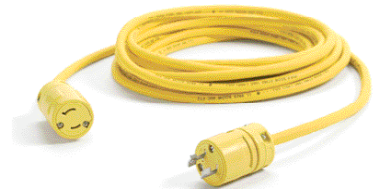

SUPER-SAFEWAY® CORDSET

**Cordset Options:** Use the following chart to modify your part's specifications. 12 & 14 gauge GFCI cordsets use SJOW cord.

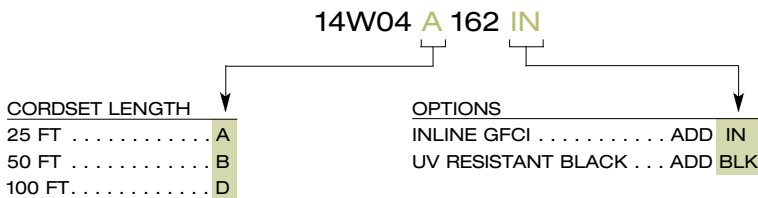

## WIRING DEVICES

### 15 AMP PLUGS AND CONNECTORS

- 125V – 2-Pole, 3-Wire – NEMA 5-15 / NEMA L5-15

Watertite® devices set the standard for the roughest, wettest and most abrasive of environments. When properly mated with corresponding connectors, Watertite® devices form an enclosure that meets the requirements of NEMA Type 4, 4X, 6 and 6P, IP65, 66 and 67, and can resist high-pressure hose-down up to 1,000 psi. Additional features include: unique multiple ring seal that locks snugly, protecting against moisture and contaminants, sturdy compression-type cord grip that provides 205 lbs. of pull-out strength, and a protective closure cap that seals the connector when it is not in use. Product photos are intended to show device style only and are not intended to reflect indicated configurations.

#### Configurations

NEMA 5-15



NEMA L5-15



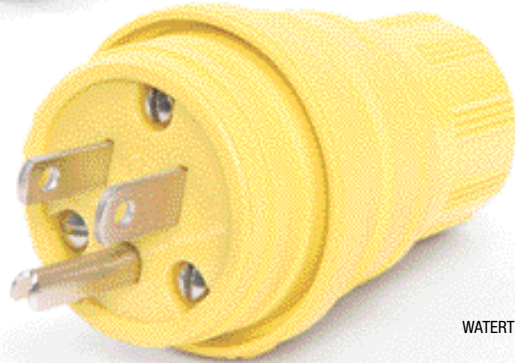

WATERTITE® CONNECTOR



WATERTITE® PLUG

### Watertite® Plugs and Connectors

| CONFIGURATION  | VOLTAGE | LOCKING BLADE (L) | PLUG PART NO. <sup>1,2</sup> | CONNECTOR PART NO. <sup>1,2</sup> | CORD GRIP BODY SIZE |
|--|---------|-------------------|------------------------------|-----------------------------------|---------------------|
| NEMA 5-15   | 125V    |                   | 14W47                        | 15W47                             | F2 ½"               |
| NEMA L5-15  | 125V    | ●                 | 24W47                        | 25W47                             | F2 ½"               |

<sup>1</sup> FOR CORD RANGES AND CORD SPECIFICATIONS, SEE PAGE 126.

<sup>2</sup> FOR EXTRA-HARD OUTDOOR USE, ORDER WATERTITE® DEVICES IN UV RESISTANT BLACK. ADD "BLK" TO THE END OF THE PART NUMBER.

WATERTITE® RECEPTACLES  
AVAILABLE (SEE PAGE 56)

PREMADE CORDSETS  
AVAILABLE  
(SEE PAGES 58-59)



MOST WOODHEAD PRODUCTS HAVE U.L. AND/OR CSA APPROVALS.  
FOR A LISTING OF APPROVALS BY PART NUMBER, SEE PAGES 262-269.

**15 AMP PLUGS AND CONNECTORS**

• 125V – 2-Pole, 3-Wire – NEMA 5-15 / NEMA L5-15

Designed for rugged industrial and commercial use, Super-Safeway® devices share some of the advanced design features of their Watertite® counterparts. Their durable rubber housing resists heat, oil, impact, and chemicals. A patented self-centering cord clamp provides superior strain-relief for a range of cable sizes while speed screws aid in quick assembly of these dead-front back-wired devices pioneered by Woodhead. New Safeway+® wiring devices feature a 3-piece rubberized-nylon assembly that locks the device together with just two screws for quick, easy assembly while providing durability and protection with a rubber-coated nylon design. Safeway® nylon plugs and connectors are Woodhead's economical solution for industrial and commercial applications. Product photos are intended to show device style only and are not intended to reflect indicated configurations.

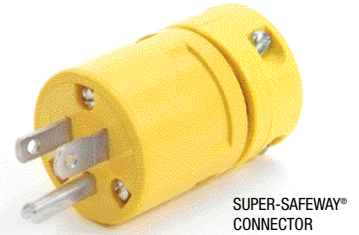

**Super-Safeway® Plugs and Connectors**

| CONFIGURATION | VOLTAGE | LOCKING BLADE (L) | PLUG PART NO. <sup>1,2</sup> | CONNECTOR PART NO. <sup>1,2</sup> |
|---------------|---------|-------------------|------------------------------|-----------------------------------|
| NEMA 5-15     | 125V    |                   | 1447                         | 1547                              |
| NEMA L5-15    | 125V    | ●                 | 2447                         | 2547                              |

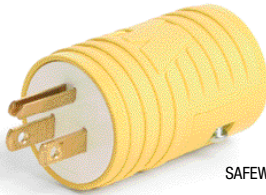

**Safeway+® Plugs and Connectors**

| CONFIGURATION | VOLTAGE | PLUG PART NO. <sup>1</sup> | CONNECTOR PART NO. <sup>1</sup> |
|---------------|---------|----------------------------|---------------------------------|
| NEMA 5-15     | 125V    | 5266-RB                    | 5269-RB                         |



**Safeway® Plugs and Connectors<sup>3</sup>**

| CONFIGURATION | VOLTAGE | LOCKING BLADE (L) | PLUG PART NO. <sup>1</sup> | CONNECTOR PART NO. <sup>1</sup> |
|---------------|---------|-------------------|----------------------------|---------------------------------|
| NEMA 5-15     | 125V    |                   | 5266                       | 5269                            |
| NEMA L5-15    | 125V    | ●                 | 4720                       | 4729                            |

<sup>1</sup> FOR CORD RANGES AND CORD SPECIFICATIONS, SEE PAGE 126.

<sup>2</sup> FOR EXTRA-HARD OUTDOOR USE, ORDER SUPER-SAFEWAY® IN UV RESISTANT BLACK. ADD "BLK" TO THE END OF THE PART NUMBER.

<sup>3</sup> TO ORDER SAFEWAY® DEVICES IN YELLOW ADD A "YL" SUFFIX TO THE WOODHEAD PART NO.

MOST WOODHEAD PRODUCTS HAVE U.L. AND/OR CSA APPROVALS. FOR A LISTING OF APPROVALS BY PART NUMBER, SEE PAGES 262-269.

## WIRING DEVICES

### 15 AMP SPECIALTY PLUGS AND CONNECTORS

- 125V – 2-Pole, 3-Wire – NEMA 5-15 / NEMA L5-15

#### Configurations

NEMA 5-15



NEMA L5-15



WATERTITE®  
MONITORING  
PLUG

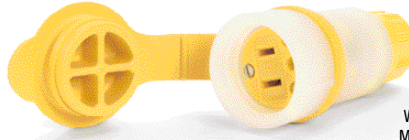

WATERTITE®  
MONITORING  
CONNECTOR

### Watertite® Monitoring Plugs and Connectors

| CONFIGURATION | VOLTAGE | LOCKING BLADE (L) | PLUG PART NO. <sup>1</sup> | CONNECTOR PART NO. <sup>1</sup> | CORD GRIP BODY SIZE |
|---------------|---------|-------------------|----------------------------|---------------------------------|---------------------|
| NEMA 5-15     | 125V    |                   | 14W47EZ                    | 15W47GCM                        | F2 ½"               |
| NEMA L5-15    | 125V    | ●                 | 24W47EZ                    | 25W47GCM                        | F2 ½"               |

SUPER-SAFEWAY®  
MONITORING PLUG

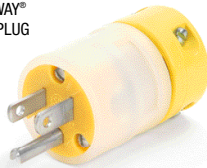

SUPER-SAFEWAY®  
CONTINUITY MONITORS

### Super-Safeway® Hospital Duty Monitoring Plugs and Connectors for ground continuity

| CONFIGURATION | VOLTAGE | LOCKING BLADE (L) | PLUG PART NO. <sup>1</sup> | CONNECTOR PART NO. <sup>1</sup> |
|---------------|---------|-------------------|----------------------------|---------------------------------|
| NEMA 5-15     | 125V    |                   | 1447EZ                     | 1547GCM                         |
| NEMA L5-15    | 125V    | ●                 | 2447EZ                     | 2547GCM                         |



HOSPITAL DUTY – PLUG

### Super-Safeway® Hospital Duty Plugs and Connectors

| CONFIGURATION | VOLTAGE | PLUG PART NO. <sup>1</sup> | CORD GRIP BODY SIZE |
|---------------|---------|----------------------------|---------------------|
| NEMA 5-15     | 125V    | 85000                      | F2 ½"               |



LIGHTED CONNECTOR – YELLOW HUSK



LIGHTED CONNECTOR – BLACK HUSK



LIGHTED CONNECTOR – HOSPITAL DUTY

### Super-Safeway® Lighted Connectors

| CONFIGURATION | VOLTAGE | CONNECTOR PART NO. <sup>1</sup> |             |            |
|---------------|---------|---------------------------------|-------------|------------|
|               |         | HOSPITAL DUTY                   | YELLOW HUSK | BLACK HUSK |
| NEMA 5-15     | 125V    | 85002                           | 15L47       | 15L47BLK   |

<sup>1</sup> FOR CORD RANGES AND CORD SPECIFICATIONS, SEE PAGE 126.

RECEPTACLES AVAILABLE  
(SEE PAGES 56-57)

PREMADE CORDSETS  
AVAILABLE  
(SEE PAGES 58-59)

UL MOST WOODHEAD PRODUCTS HAVE U.L. AND/OR CSA APPROVALS.  
FOR A LISTING OF APPROVALS BY PART NUMBER, SEE PAGES 262-269.



**15 AMP SPECIALTY PLUGS AND CONNECTORS**

• 125V – 2-Pole, 3-Wire – NEMA 5-15



BLACK PLUG



YELLOW PLUG



TRANSPARENT PLUG



BLACK CONNECTOR



YELLOW CONNECTOR



TRANSPARENT CONNECTOR

**Safeway® Hospital Duty Plugs and Connectors**

| CONFIGURATION | VOLTAGE | PLUG PART NO. <sup>1</sup> |         |             | CONNECTOR PART NO. <sup>1</sup> |         |             |
|---------------|---------|----------------------------|---------|-------------|---------------------------------|---------|-------------|
|               |         | BLACK                      | YELLOW  | TRANSPARENT | BLACK                           | YELLOW  | TRANSPARENT |
| NEMA 5-15     | 125V    | 85266                      | 85266YL | 85447       | 85269                           | 85269YL | 85547       |

**Safeway® Right Angle Plugs**

| CONFIGURATION | VOLTAGE | PLUG PART NO. <sup>1</sup> |                            |
|---------------|---------|----------------------------|----------------------------|
|               |         | YELLOW                     | HOSPITAL GRADE TRANSPARENT |
| NEMA 5-15     | 125V    | 14R47                      | 85050                      |



YELLOW RIGHT ANGLE PLUGS



TRANSPARENT RIGHT ANGLE PLUGS

**Safeway® Individually Fused Plugs**

| CONFIGURATION | VOLTAGE | PLUG PART NO. <sup>1</sup> |                            |
|---------------|---------|----------------------------|----------------------------|
|               |         | YELLOW                     | HOSPITAL GRADE TRANSPARENT |
| NEMA 5-15     | 125V    | 14F47                      | 85125                      |



YELLOW INDIVIDUALLY FUSED GROUNDING PLUG



HOSPITAL GRADE TRANSPARENT INDIVIDUALLY FUSED GROUNDING PLUG

**Safeway® Lighted Plugs and Connectors**

| CONFIGURATION | VOLTAGE | PLUG PART NO. | CONNECTOR PART NO. <sup>1</sup> |
|---------------|---------|---------------|---------------------------------|
| NEMA 5-15     | 125V    | 85447L        | 5269L                           |

<sup>1</sup> FOR CORD RANGES AND CORD SPECIFICATIONS, SEE PAGE 126.



LIGHTED DEVICES – PLUG



LIGHTED DEVICES – CONNECTOR

MOST WOODHEAD PRODUCTS HAVE U.L. AND/OR CSA APPROVALS. FOR A LISTING OF APPROVALS BY PART NUMBER, SEE PAGES 262-269.



## WIRING DEVICES

### 15 AMP RECEPTACLES

- 125V – 2-Pole, 3-Wire – NEMA 5-15 / NEMA L5-15

Woodhead meets your receptacle needs head-on. Single, duplex or motor-base receptacles for wet abusive environments are covered by Watertite® product solutions while general industrial applications are well served by nylon Safeway® receptacles. Watertite® receptacles feature spring-loaded flip lid covers with built-in lock-out/tag-out capabilities and the patented triple seal for the best in wet-location protection. Product photos are intended to show device style only and are not intended to reflect indicated configurations.

#### Configurations

NEMA 5-15



NEMA L5-15



WATERTITE® DUPLEX FLIP LID



WATERTITE® SINGLE FLIP LID



WATERTITE® FLIP LID  
W/ MALE RECEPTACLE



WATERTITE® CONNECTOR FOR  
FLIP LID W/ MALE RECEPTACLE

### Watertite® Receptacles with Flip Coverplates

| CONFIGURATION | VOLTAGE | LOCKING BLADE (L) | SINGLE FLIP LID | DUPLEX FLIP LID | FLIP LID WITH MALE RECEPTACLE | CONNECTOR FOR FLIP LID WITH MALE RECEPTACLE |
|---------------|---------|-------------------|-----------------|-----------------|-------------------------------|---|
| NEMA 5-15     | 125V    |                   | 60W47           | 60W47DPLX       | 59W47                         | 15W47MB                                     |
| NEMA L5-15    | 125V    | ●                 | 65W47           | 65W47DPLX       | 64W47                         | 25W47MB                                     |

### Watertite® Duplex GFCI Receptacle

| CONFIGURATION | VOLTAGE | RECEPTACLE PART NO. |
|---------------|---------|---------------------|
| NEMA 5-15     | 125V    | 60W47DPLXGF         |
| NEMA L5-15    | 125V    | 65W47DPLXGF         |



WATERTITE® DUPLEX  
GFCI RECEPTACLE

### Watertite® Pigtail Outlet

| CONFIGURATION | VOLTAGE | OUTLET PART NO. |
|---------------|---------|-----------------|
| NEMA 5-15     | 125V    | 647             |



MOST WOODHEAD PRODUCTS HAVE U.L. AND/OR CSA APPROVALS.  
FOR A LISTING OF APPROVALS BY PART NUMBER, SEE PAGES 262-269.

**15 AMP RECEPTACLES**

- 125V – 2-Pole, 3-Wire – NEMA 5-15 / NEMA L5-15

Woodhead meets your receptacle needs head-on. Single, duplex or motor-base receptacles for wet abusive environments are covered by Woodhead Watertite® product solutions while general industrial applications are well served by nylon Safeway® receptacles. Watertite® receptacles feature spring-loaded flip lid covers with built-in lock-out/tag-out capabilities and the patented triple seal for the best in wet-location protection. Product photos are intended to show device style only and are not intended to reflect indicated configurations.

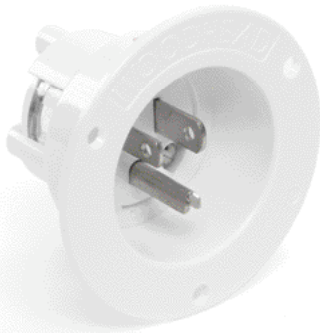

SAFEWAY® FLANGED INLET

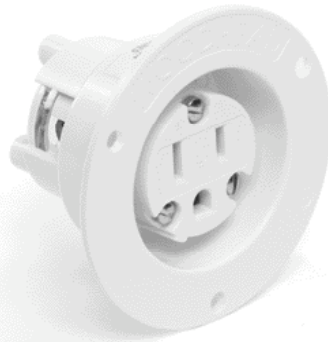

SAFEWAY® FLANGED RECEPTACLES



SAFEWAY® DUPLEX RECEPTACLE

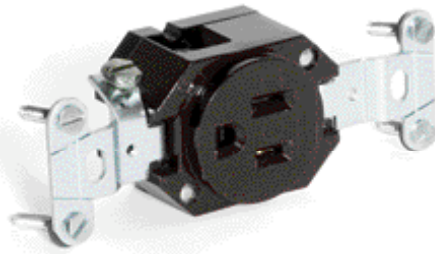

SAFEWAY® SINGLE RECEPTACLE

**Safeway® Receptacles and Inlets**

| CONFIGURATION | VOLTAGE | LOCKING BLADE (L) | FLANGED INLET | FLANGED RECEPTACLE | DUPLEX SPEC-GRADE RECEPTACLE <sup>1,2</sup> | HEAVY-DUTY SPEC-GRADE RECEPTACLE |                     |
|---------------|---------|-------------------|---------------|--------------------|---|----------------------------------|---------------------|
|               |         |                   |               |                    |   | DUPLEX <sup>1</sup>              | SINGLE <sup>1</sup> |
| NEMA 5-15     | 125V    |                   | 1447MB        | 1547MB             | 5252DW                                      | 5262DW                           | 5261DW              |
| NEMA L5-15    | 125V    | ●                 | 2447MB        | 2547MB             | —   | 4700DW                           | —                   |

<sup>1</sup> STANDARD COLOR IS BROWN

<sup>2</sup> FOR CORROSION-RESISTANT RECEPTACLE, ADD "CR" SUFFIX TO THE PART NO. (E.G. 5256DWCR)

# WIRING DEVICES

## 15 AMP CORDSETS

- 125V – 2-Pole, 3-Wire – NEMA 5-15 / NEMA L5-15

Factory pre-made Watertite® or Super-Safeway® cordsets are made from heavy-duty SOW cord and the appropriate connector bodies that fit your environment. Product photos are intended to show style only and are not intended to reflect indicated configurations.

### Configurations

NEMA 5-15



NEMA L5-15



WATERTITE® CORDSET

### Watertite® Cordsets

| CONFIGURATION | VOLTAGE | 16-GAUGE SOW CORDSETS | 14-GAUGE SOW CORDSETS |
|---------------|---------|-----------------------|-----------------------|
| NEMA 5-15     | 125V    | 14W47_163             | 14W47_143             |
| NEMA L5-15    | 125V    | 24W47_163             | 24W47_143             |

### Super-Safeway® Cordsets

| CONFIGURATION | VOLTAGE | 16-GAUGE SOW CORDSETS | 14-GAUGE SOW CORDSETS |
|---------------|---------|-----------------------|-----------------------|
| NEMA 5-15     | 125V    | 1447_163              | 1447_143              |
| NEMA L5-15    | 125V    | 2447_163              | 2447_143              |



SUPER-SAFEWAY® CORDSET

**Cordset Options:** Use the following chart to modify your part's specifications. (12 & 14 gauge GFCI cordsets use SJOW cord.)

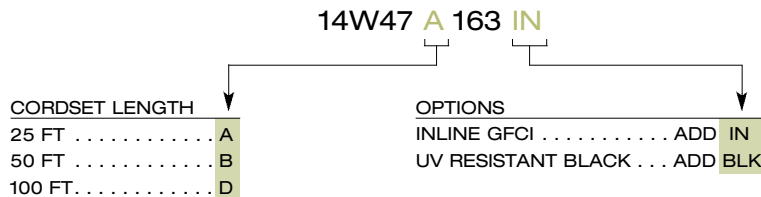

MOST WOODHEAD PRODUCTS HAVE U.L. AND/OR CSA APPROVALS. FOR A LISTING OF APPROVALS BY PART NUMBER, SEE PAGES 262-269.

**15 AMP SPECIALTY CORDSETS**

- 125V – 2-Pole, 3-Wire – NEMA 5-15 / NEMA L5-15

Molded “Y” and “W” cordsets are high quality, custom-made adapters that provide multiple outlets from a single source. They are made from heavy-duty SOW cord and the appropriate connector bodies that fit your environment. When ordering custom cordsets, the amperage and voltage of the plug must be equal to or greater than that of the connectors. Approximate overall length of the product is 3 ft. Product photos are intended to show device style only and are not intended to reflect indicated configurations.



WATERTITE® MOLDED Y CORDSET



WATERTITE® MOLDED W CORDSET

**Watertite® Molded Cordsets**

| CONFIGURATION | VOLTAGE | MOLDED Y CORDSET |                                | MOLDED W CORDSET |                                |
|---------------|---------|------------------|--------------------------------|------------------|--------------------------------|
|               |         | STANDARD         | WITH IN-LINE GFCI <sup>1</sup> | STANDARD         | WITH IN-LINE GFCI <sup>1</sup> |
| NEMA 5-15     | 125V    | 14W47-Y          | 14W47-Y-IN                     | 14W47-Y          | 14W47-Y-IN                     |
| NEMA L5-15    | 125V    | 24W47-Y          | 24W47-Y-IN                     | 24W47-Y          | 24W47-Y-IN                     |

<sup>1</sup> IN-LINE GFCI CORDSETS USE S.JOW CORD.



MOLDED Y CORDSET



MOLDED W CORDSET

**Super Safeway® Molded Cordsets**

| CONFIGURATION | VOLTAGE | MOLDED Y CORDSET |                                | MOLDED W CORDSET |                                |
|---------------|---------|------------------|--------------------------------|------------------|--------------------------------|
|               |         | STANDARD         | WITH IN-LINE GFCI <sup>1</sup> | STANDARD         | WITH IN-LINE GFCI <sup>1</sup> |
| NEMA 5-15     | 125V    | 1447-Y           | 1447-Y-IN                      | 1447-W           | 1447-W-IN                      |
| NEMA L5-15    | 125V    | 2447-Y           | 2447-Y-IN                      | 2447-W           | 2447-W-IN                      |

<sup>1</sup> IN-LINE GFCI CORDSETS USE S.JOW CORD.



MOST WOODHEAD PRODUCTS HAVE U.L. AND/OR CSA APPROVALS. FOR A LISTING OF APPROVALS BY PART NUMBER, SEE PAGES 262-269.

## WIRING DEVICES

### 15 AMP PLUGS AND CONNECTORS

- 250V – 2-Pole, 3-Wire – NEMA 6-15 / NEMA L6-15
- 277V – 2-Pole, 3-Wire – NEMA 7-15 / NEMA L7-15

Watertite® devices set the standard for the roughest, wettest and most abrasive of environments. When properly mated with corresponding connectors, Watertite® devices form an enclosure that meets the requirements of NEMA Type 4, 4X, 6 and 6P, IP65, 66 and 67, and can resist high-pressure hose-down up to 1,000 psi. Additional features include: unique multiple ring seal that locks snugly, protecting against moisture and contaminants, sturdy compression-type cord grip that provides 205 lbs. of pull-out strength, and a protective closure cap that seals the connector when it is not in use. Product photos are intended to show device style only and are not intended to reflect indicated configurations.

#### Configurations

|            |  |
|------------|--|
| NEMA 6-15  |  |
| NEMA L6-15 |  |
| NEMA 7-15  |  |
| NEMA L7-15 |  |



WATERTITE® CONNECTOR

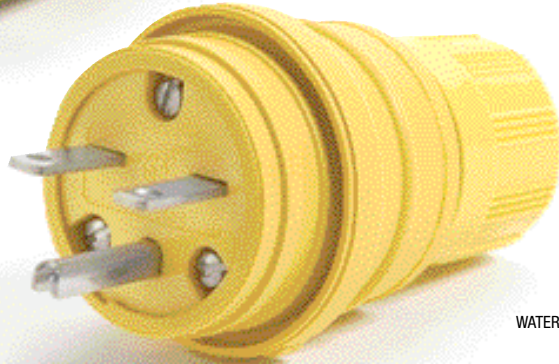

WATERTITE® PLUG

### Watertite® Plugs and Connectors

| CONFIGURATION | VOLTAGE | LOCKING BLADE (L) | PLUG PART NO. <sup>1,2</sup> | CONNECTOR PART NO. <sup>1,2</sup> | CORD GRIP BODY SIZE |
|---------------|---------|-------------------|------------------------------|-----------------------------------|---------------------|
| NEMA 6-15     | 250V    |                   | 14W49                        | 15W49                             | F2 ½"               |
| NEMA L6-15    | 250V    | ●                 | 24W49                        | 25W49                             | F2 ½"               |
| NEMA 7-15     | 277V    |                   | 14W34                        | 15W34                             | F2 ½"               |
| NEMA L7-15    | 277V    | ●                 | 24W34                        | 25W34                             | F2 ½"               |

<sup>1</sup> FOR CORD RANGES AND CORD SPECIFICATIONS, SEE PAGE 126.

<sup>2</sup> FOR EXTRA-HARD OUTDOOR USE, ORDER WATERTITE® DEVICES IN UV RESISTANT BLACK. ADD "BLK" TO THE END OF THE PART NUMBER.

WATERTITE® RECEPTACLES  
AVAILABLE (SEE PAGE 62)

PREMADE CORDSETS  
AVAILABLE (SEE PAGE 63)

MOST WOODHEAD PRODUCTS HAVE U.L. AND/OR CSA APPROVALS.  
FOR A LISTING OF APPROVALS BY PART NUMBER, SEE PAGES 262-269.

**15 AMP PLUGS AND CONNECTORS**

- 250V – 2-Pole, 3-Wire – NEMA 6-15 / NEMA L6-15
- 277V – 2-Pole, 3-Wire – NEMA 7-15 / NEMA L7-15

Designed for rugged industrial and commercial use, Super-Safeway® devices share some of the advanced design features of their Watertite® counterparts. Their durable rubber housing resists heat, oil, impact, and chemicals. A patented self-centering cord clamp provides superior strain-relief for a range of cable sizes while speed screws aid in quick assembly of these dead-front back-wired devices pioneered by Woodhead. Safeway® nylon plugs and connectors are Woodhead's economical solution for industrial and commercial applications. Product photos are intended to show device style only and are not intended to reflect indicated configurations.

SUPER-SAFEWAY® PLUG

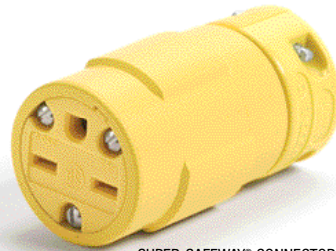

SUPER-SAFEWAY® CONNECTOR

**Super-Safeway® Plugs and Connectors**

| CONFIGURATION | VOLTAGE | LOCKING BLADE (L) | PLUG PART NO. <sup>1</sup> | CONNECTOR PART NO. <sup>1</sup> |
|---------------|---------|-------------------|----------------------------|---------------------------------|
| NEMA 6-15     | 250V    |                   | 1449                       | 1549                            |
| NEMA L6-15    | 250V    | ●                 | 2449                       | 2549                            |
| NEMA 7-15     | 277V    |                   | 1434                       | 1534                            |
| NEMA L7-15    | 277V    | ●                 | 2434                       | 2534                            |

SAFEWAY® PLUG



SAFEWAY® CONNECTOR

**Safeway® Plugs and Connectors<sup>2</sup>**

| CONFIGURATION | VOLTAGE | LOCKING BLADE (L) | PLUG PART NO. | CONNECTOR PART NO. |
|---------------|---------|-------------------|---------------|--------------------|
| NEMA 6-15     | 250V    |                   | 5666          | 5669               |
| NEMA L6-15    | 250V    | ●                 | 24T49         | 25T49              |
| NEMA 7-15     | 277V    |                   | 5766          | 5769               |
| NEMA L7-15    | 277V    | ●                 | 4770          | 4779               |

<sup>1</sup> FOR EXTRA-HARD OUTDOOR USE, ORDER SUPER-SAFEWAY® DEVICES IN UV RESISTANT BLACK. ADD "BLK" TO THE END OF THE PART NUMBER.

<sup>2</sup> TO ORDER SAFEWAY® DEVICE IN YELLOW ADD A "YL" SUFFIX TO THE WOODHEAD PART NO.



## WIRING DEVICES

### 15 AMP RECEPTACLES

- 250V – 2-Pole, 3-Wire – NEMA 6-15 / NEMA L6-15
- 277V – 2-Pole, 3-Wire – NEMA 7-15 / NEMA L7-15

Woodhead meets your receptacle needs head-on. Single, duplex or motor-base receptacles for wet abusive environments are covered by Watertite® product solutions while general industrial applications are well served by nylon Safeway® receptacles. Watertite® receptacles feature spring-loaded flip lid covers with built-in lock-out/tag-out capabilities and the patented triple seal for the best in wet-location protection. Product photos are intended to show device style only and are not intended to reflect indicated configurations.

#### Configurations



WATERTITE® SINGLE FLIP LID



WATERTITE® DUPLEX FLIP LID



WATERTITE® FLIP LID  
W/ MALE RECEPTACLE



WATERTITE® CONNECTOR FOR  
FLIP LID W/ MALE RECEPTACLE

### Watertite® Receptacles with Flip Coverplates

| CONFIGURATION | VOLTAGE | LOCKING BLADE (L) | SINGLE FLIP LID | DUPLEX FLIP LID | FLIP LID WITH MALE RECEPTACLE | CONNECTOR FOR FLIP LID WITH MALE RECEPTACLE |
|---------------|---------|-------------------|-----------------|-----------------|-------------------------------|---|
| NEMA 6-15     | 250V    |                   | 60W49           | 60W49DPLX       | 59W49                         | 15W49MB                                     |
| NEMA L6-15    | 250V    | ●                 | 65W49           | 65W49DPLX       | 64W49                         | 25W49MB                                     |
| NEMA 7-15     | 277V    |                   | 60W34           | 60W34DPLX       | 59W34                         | 15W34MB                                     |
| NEMA L7-15    | 277V    | ●                 | 65W34           | 65W34DPLX       | 64W34                         | 25W34MB                                     |



SAFEWAY® FLANGED INLET



SAFEWAY® FLANGED RECEPTACLES



SAFEWAY® DUPLEX  
RECEPTACLE

### Safeway® Receptacles and Inlets

| CONFIGURATION | VOLTAGE | LOCKING BLADE (L) | FLANGED INLET | FLANGED RECEPTACLE | DUPLEX RECEPTACLES        |                           |
|---------------|---------|-------------------|---------------|--------------------|---------------------------|---------------------------|
|               |         |                   |               |                    | SPEC GRADE <sup>1,2</sup> | HEAVY DUTY <sup>2,3</sup> |
| NEMA 6-15     | 250V    |                   | 1449MB        | 1549MB             | 5652DW                    | 5662DW                    |
| NEMA L6-15    | 250V    | ●                 | 2449MB        | 2549MB             | —                         | —                         |
| NEMA 7-15     | 277V    |                   | 1434MB        | 1534MB             | —                         | —                         |
| NEMA L7-15    | 277V    | ●                 | 2434MB        | 2534MB             | —                         | —                         |

<sup>1</sup> STANDARD COLOR IS BROWN

<sup>2</sup> FOR CORROSION-RESISTANT RECEPTACLE, ADD "CR" SUFFIX TO THE PART NO. (E.G. 4949CR)

<sup>3</sup> STANDARD COLOR IS BLACK



MOST WOODHEAD PRODUCTS HAVE U.L. AND/OR CSA APPROVALS.  
FOR A LISTING OF APPROVALS BY PART NUMBER, SEE PAGES 262-269.

WATERTITE® PLUGS  
AND CONNECTORS  
AVAILABLE (SEE PAGE 60)

**15 AMP CORDSETS**

- 250V – 2-Pole, 3-Wire – NEMA 6-15 / NEMA L6-15
- 277V – 2-Pole, 3-Wire – NEMA 7-15 / NEMA L7-15

Factory pre-made Watertite® or Super-Safeway® cordsets are made from heavy-duty SOW cord and the appropriate connector bodies that fit your environment. Product photos are intended to show style only and are not intended to reflect indicated configurations.

WATERTITE® CORDSET



**Watertite® Cordsets**

| CONFIGURATION |    | VOLTAGE | 16-GAUGE SOW CORDSETS | 14-GAUGE SOW CORDSETS |
|---------------|----|---------|-----------------------|-----------------------|
| NEMA 6-15     | ☺☺ | 250V    | 14W49_163             | 14W49_143             |
| NEMA L6-15    | ☺☺ | 250V    | 24W49_163             | 24W49_143             |
| NEMA 7-15     | ☺☺ | 277V    | 14W34_163             | 14W34_143             |
| NEMA L7-15    | ☺☺ | 277V    | 24W34_163             | 24W34_143             |

**Super-Safeway® Cordsets**

| CONFIGURATION |    | VOLTAGE | 16-GAUGE SOW CORDSETS | 14-GAUGE SOW CORDSETS |
|---------------|----|---------|-----------------------|-----------------------|
| NEMA 6-15     | ☺☺ | 250V    | 1449_163              | 1449_143              |
| NEMA L6-15    | ☺☺ | 250V    | 2449_163              | 2449_143              |
| NEMA 7-15     | ☺☺ | 277V    | 1434_163              | 1434_143              |
| NEMA L7-15    | ☺☺ | 277V    | 2434_163              | 2434_143              |



SUPER-SAFEWAY® CORDSET

**Cordset Options:** Use the following chart to modify your part's specifications. 12 & 14 gauge GFCI cordsets use SJOW cord.

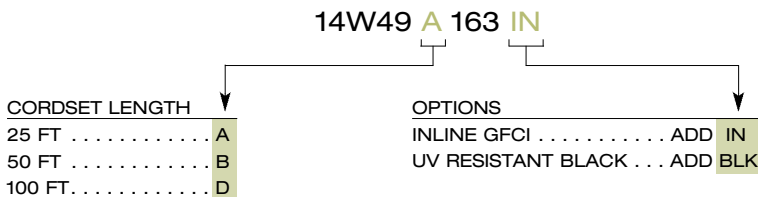

MOST WOODHEAD PRODUCTS HAVE U.L. AND/OR CSA APPROVALS. FOR A LISTING OF APPROVALS BY PART NUMBER, SEE PAGES 262-269.

## WIRING DEVICES

### 15 AMP DUAL RATED PLUGS AND CONNECTORS

- 15A/125V, 10A/250V – 3-Pole, 3-Wire – Non-NEMA / Non-NEMA Locking

Watertite® devices set the standard for the roughest, wettest and most abrasive of environments. When properly mated with corresponding connectors, Watertite® devices form an enclosure that meets the requirements of NEMA Type 4, 4X, 6 and 6P, IP65, 66 and 67, and can resist high-pressure hose-down up to 1,000 psi. Additional features include: Unique multiple ring seal that locks snugly, protecting against moisture and contaminants, sturdy compression-type cord grip that provides 205 lbs. of pull-out strength, and a protective closure cap that seals the connector when it is not in use. Product photos are intended to show device style only and are not intended to reflect indicated configurations.

#### Configurations

Non-NEMA



Non-NEMA Locking



WATERTITE® CONNECTOR



WATERTITE® PLUG

### Watertite® Plugs and Connectors

| CONFIGURATION    | VOLTAGE            | LOCKING BLADE (L) | PLUG PART NO. <sup>1,2</sup> | CONNECTOR PART NO. <sup>1,2</sup> | CORD GRIP BODY SIZE |
|------------------|--------------------|-------------------|------------------------------|-----------------------------------|---------------------|
| NON-NEMA         | 15A/125V, 10A/250V |                   | 14W07                        | 15W07                             | F2 ½"               |
| NON-NEMA LOCKING | 15A/125V, 10A/250V | ●                 | 24W07                        | 25W07                             | F2 ½"               |

<sup>1</sup> FOR CORD RANGES AND CORD SPECIFICATIONS, SEE PAGES 126.

<sup>2</sup> FOR EXTRA-HARD OUTDOOR USE, ORDER WATERTITE® DEVICES IN UV RESISTANT BLACK. ADD "BLK" TO THE END OF THE PART NUMBER.

WATERTITE® RECEPTACLES  
AVAILABLE (SEE PAGE 66)

PREMADE CORDSETS  
AVAILABLE (SEE PAGE 67)



MOST WOODHEAD PRODUCTS HAVE U.L. AND/OR CSA APPROVALS.  
FOR A LISTING OF APPROVALS BY PART NUMBER, SEE PAGES 262-269.

## 15 AMP DUAL RATED PLUGS AND CONNECTORS

- 15A/125V, 10A/250V – 3-Pole, 3-Wire – Non-NEMA / Non-NEMA Locking

Designed for rugged industrial and commercial use, Super-Safeway® devices share some of the advanced design features of their Watertite® counterparts. Their durable rubber housing resists heat, oil, impact, and chemicals. A patented self-centering cord clamp provides superior strain-relief for a range of cable sizes while speed screws aid in quick assembly of these dead-front back-wired devices pioneered by Woodhead. Safeway® nylon plugs and connectors are Woodhead's economical solution for industrial and commercial applications. Product photos are intended to show device style only and are not intended to reflect indicated configurations.

SUPER-SAFEWAY® PLUG

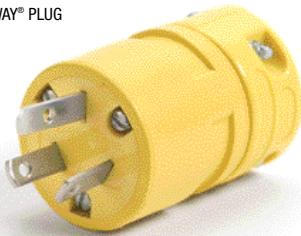

SUPER-SAFEWAY® CONNECTOR

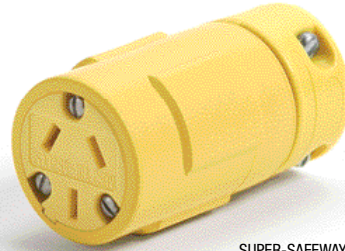

### Super-Safeway® Plugs and Connectors

| CONFIGURATION    | VOLTAGE            | LOCKING BLADE (L) | PLUG PART NO. <sup>1,2</sup> | CONNECTOR PART NO. <sup>1,2</sup> |
|------------------|--------------------|-------------------|------------------------------|-----------------------------------|
| NON-NEMA         | 15A/125V, 10A/250V |                   | 1407                         | 1507                              |
| NON-NEMA LOCKING | 15A/125V, 10A/250V | ●                 | 2407                         | 2507                              |

SAFEWAY® PLUG



SAFEWAY® CONNECTOR



### Safeway® Plugs and Connectors<sup>3</sup>

| CONFIGURATION    | VOLTAGE            | LOCKING BLADE (L) | PLUG PART NO. <sup>1</sup> | CONNECTOR PART NO. <sup>1</sup> |
|------------------|--------------------|-------------------|----------------------------|---------------------------------|
| NON-NEMA         | 15A/125V, 10A/250V |                   | 5276                       | 1507                            |
| NON-NEMA LOCKING | 15A/125V, 10A/250V | ●                 | 4730                       | 4739                            |

<sup>1</sup> FOR CORD RANGES AND CORD SPECIFICATIONS, SEE PAGE 126.

<sup>2</sup> FOR EXTRA-HARD OUTDOOR USE, ORDER SUPER-SAFEWAY® DEVICES IN UV RESISTANT BLACK. ADD "BLK" TO THE END OF THE PART NUMBER.

<sup>3</sup> TO ORDER SAFEWAY® DEVICE IN YELLOW ADD A "YL" SUFFIX TO THE WOODHEAD PART NO.



MOST WOODHEAD PRODUCTS HAVE U.L. AND/OR CSA APPROVALS. FOR A LISTING OF APPROVALS BY PART NUMBER, SEE PAGES 262-269.

## WIRING DEVICES

### 15 AMP DUAL RATED RECEPTACLES

- 15A/125V, 10A/250V – 3-Pole, 3-Wire – Non-NEMA / Non-NEMA Locking

Woodhead meets your receptacle needs head-on. Single, duplex or motor-base receptacles for wet abusive environments are covered by Watertite® product solutions while general industrial applications are well served by nylon Safeway® receptacles. Watertite® receptacles feature spring-loaded flip lid covers with built-in lock-out/tag-out capabilities and the patented triple seal for the best in wet-location protection. Product photos are intended to show device style only and are not intended to reflect indicated configurations.

#### Configurations

Non-NEMA



Non-NEMA Locking



WATERTITE® SINGLE FLIP LID



WATERTITE® DUPLEX FLIP LID



WATERTITE® FLIP LID  
W/ MALE RECEPTACLE



WATERTITE® CONNECTOR FOR  
FLIP LID W/ MALE RECEPTACLE

### Watertite® Receptacles with Flip Coverplates

| CONFIGURATION    | VOLTAGE            | LOCKING BLADE (L) | SINGLE FLIP LID | DUPLEX FLIP LID | FLIP LID WITH MALE RECEPTACLE | CONNECTOR FOR FLIP LID WITH MALE RECEPTACLE |
|------------------|--------------------|-------------------|-----------------|-----------------|-------------------------------|---|
| NON-NEMA         | 15A/125V, 10A/250V |                   | 60W07           | 60W07DPLX       | 59W07                         | 15W07MB                                     |
| NON-NEMA LOCKING | 15A/125V, 10A/250V | ●                 | 65W07           | 65W07DPLX       | 64W07                         | 25W07MB                                     |

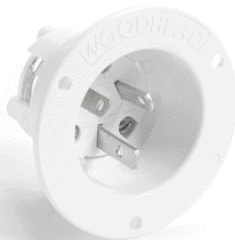

SAFEWAY® FLANGED INLET

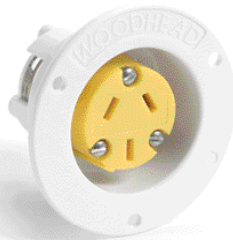

SAFEWAY® FLANGED RECEPTACLES

### Safeway® Receptacles and Inlets

| CONFIGURATION    | VOLTAGE            | LOCKING BLADE (L) | FLANGED INLET | FLANGED RECEPTACLE |
|------------------|--------------------|-------------------|---------------|--------------------|
| NON-NEMA         | 15A/125V, 10A/250V |                   | 1407MB        | 1507MB             |
| NON-NEMA LOCKING | 15A/125V, 10A/250V | ●                 | 2407MB        | 2507MB             |



MOST WOODHEAD PRODUCTS HAVE U.L. AND/OR CSA APPROVALS.  
FOR A LISTING OF APPROVALS BY PART NUMBER, SEE PAGES 262-269.

WATERTITE® PLUGS  
AND CONNECTORS  
AVAILABLE (SEE PAGE 64)



**15 AMP DUAL RATED CORDSETS**

- 15A/125V, 10A/250V – 3-Pole, 3-Wire – Non-NEMA / Non-NEMA Locking

Factory pre-made Watertite® or Super-Safeway® cordsets are made from heavy-duty SOW cord and the appropriate connector bodies that fit your environment. Product photos are intended to show style only and are not intended to reflect indicated configurations.

WATERTITE® CORDSET



**Watertite® Cordsets**

| CONFIGURATION       | VOLTAGE            | 16-GAUGE SOW CORDSETS | 14-GAUGE SOW CORDSETS |
|---------------------|--------------------|-----------------------|-----------------------|
| NON-NEMA ☺☺         | 15A/125V, 10A/250V | 14W07_163             | 14W07_143             |
| NON-NEMA LOCKING ☺☹ | 15A/125V, 10A/250V | 24W07_163             | 24W07_143             |

**Super-Safeway® Cordsets**

| CONFIGURATION       | VOLTAGE            | 16-GAUGE SOW CORDSETS | 14-GAUGE SOW CORDSETS |
|---------------------|--------------------|-----------------------|-----------------------|
| NON-NEMA ☺☺         | 15A/125V, 10A/250V | 1407_163              | 1407_143              |
| NON-NEMA LOCKING ☺☹ | 15A/125V, 10A/250V | 2407_163              | 2407_143              |



SUPER-SAFEWAY® CORDSET

**Cordset Options:** Use the following chart to modify your part's specifications. 12 & 14 gauge GFCI cordsets use SJOW cord.

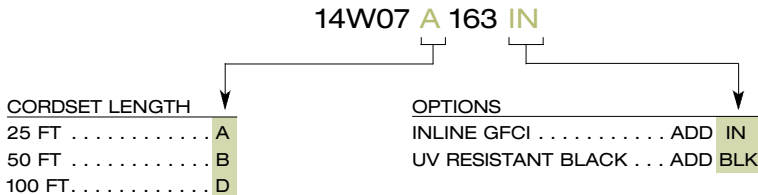

MOST WOODHEAD PRODUCTS HAVE U.L. AND/OR CSA APPROVALS. FOR A LISTING OF APPROVALS BY PART NUMBER, SEE PAGES 262-269.



## WIRING DEVICES

### 20 AMP PLUGS AND CONNECTORS

- 250V – 2-Pole, 2-Wire – NEMA L2-20

Watertite® devices set the standard for the roughest, wettest and most abrasive of environments. When properly mated with corresponding connectors, Watertite® devices form an enclosure that meets the requirements of NEMA Type 4, 4X, 6 and 6P, IP65, 66 and 67, and can resist high-pressure hose-down up to 1,000 psi. Additional features include: Unique multiple ring seal that locks snugly, protecting against moisture and contaminants, sturdy compression-type cord grip that provides 205 lbs. of pull-out strength, and a protective closure cap that seals the connector when it is not in use. Product photos are intended to show device style only and are not intended to reflect indicated configurations.

#### Configurations

NEMA L2-20



WATERTITE® CONNECTOR



WATERTITE® PLUG

### Watertite® Plugs and Connectors

| CONFIGURATION | VOLTAGE | LOCKING BLADE (L) | PLUG PART NO. <sup>1,2</sup> | CONNECTOR PART NO. <sup>1,2</sup> | CORD GRIP BODY SIZE |
|---------------|---------|-------------------|------------------------------|-----------------------------------|---------------------|
| NEMA L2-20    | 250V    | ●                 | 26W07                        | 27W07                             | F2 ½"               |

<sup>1</sup> FOR CORD RANGES AND CORD SPECIFICATIONS, SEE PAGE 126.

<sup>2</sup> FOR EXTRA-HARD OUTDOOR USE, ORDER WATERTITE® DEVICES IN UV RESISTANT BLACK. ADD "BLK" TO THE END OF THE PART NUMBER.

WATERTITE® RECEPTACLES  
AVAILABLE (SEE PAGE 70)

PREMADE CORDSETS  
AVAILABLE (SEE PAGE 71)

 MOST WOODHEAD PRODUCTS HAVE U.L. AND/OR CSA APPROVALS.  
FOR A LISTING OF APPROVALS BY PART NUMBER, SEE PAGES 262-269.

## 20 AMP PLUGS AND CONNECTORS

- 250V – 2-Pole, 2-Wire – NEMA L2-20

Designed for rugged industrial and commercial use, Super-Safeway® devices share some of the advanced design features of their Watertite® counterparts. Their durable rubber housing resists heat, oil, impact, and chemicals. A patented self-centering cord clamp provides superior strain-relief for a range of cable sizes while speed screws aid in quick assembly of these dead-front back-wired devices pioneered by Woodhead. Safeway® nylon plugs and connectors are Woodhead's economical solution for industrial and commercial applications. Product photos are intended to show device style only and are not intended to reflect indicated configurations.

SUPER-SAFEWAY® PLUG

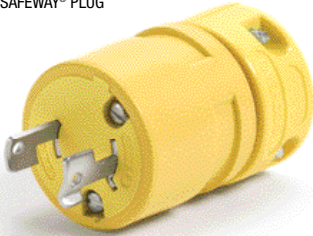

SUPER-SAFEWAY® CONNECTOR

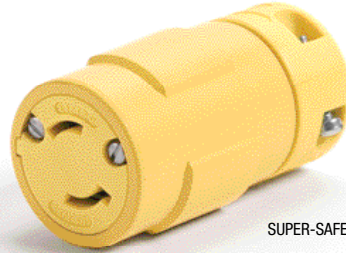

### Super-Safeway® Plugs and Connectors

| CONFIGURATION | VOLTAGE | LOCKING BLADE (L) | PLUG PART NO. <sup>1,2</sup> | CONNECTOR PART NO. <sup>1,2</sup> |
|---------------|---------|-------------------|------------------------------|-----------------------------------|
| NEMA L2-20    | 250V    |                   | 2607                         | 2707                              |

SAFEWAY® PLUG



SAFEWAY® CONNECTOR



### Safeway® Plugs and Connectors<sup>3</sup>

| CONFIGURATION | VOLTAGE | LOCKING BLADE (L) | PLUG PART NO. <sup>1</sup> | CONNECTOR PART NO. <sup>1</sup> |
|---------------|---------|-------------------|----------------------------|---------------------------------|
| NEMA L2-20    | 250V    |                   | 26T07                      | 27T07                           |

<sup>1</sup> FOR CORD RANGES AND CORD SPECIFICATIONS, SEE PAGE 126.

<sup>2</sup> FOR EXTRA-HARD OUTDOOR USE, ORDER SUPER-SAFEWAY® DEVICES IN UV RESISTANT BLACK. ADD "BLK" TO THE END OF THE PART NUMBER.

<sup>3</sup> TO ORDER SAFEWAY® DEVICE IN YELLOW ADD A "YL" SUFFIX TO THE WOODHEAD PART NO.



MOST WOODHEAD PRODUCTS HAVE U.L. AND/OR CSA APPROVALS. FOR A LISTING OF APPROVALS BY PART NUMBER, SEE PAGES 262-269.

## WIRING DEVICES

### 20 AMP RECEPTACLES

- 250V – 2-Pole, 2-Wire – NEMA L2-20

Woodhead meets your receptacle needs head-on. Single, duplex or motor-base receptacles for wet abusive environments are covered by Watertite® product solutions while general industrial applications are well served by nylon Safeway® receptacles. Watertite® receptacles feature spring-loaded flip lid covers with built-in lock-out/tag-out capabilities and the patented triple seal for the best in wet-location protection. Product photos are intended to show device style only and are not intended to reflect indicated configurations.

#### Configurations

NEMA L2-20



WATERTITE® SINGLE FLIP LID

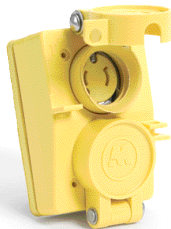

WATERTITE® DUPLEX FLIP LID

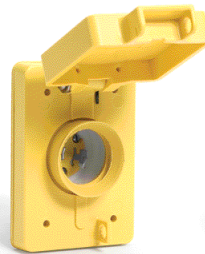

WATERTITE® FLIP LID  
W/ MALE RECEPTACLE

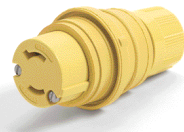

WATERTITE® CONNECTOR FOR  
FLIP LID W/ MALE RECEPTACLE

### Watertite® Receptacles with Flip Coverplates

| CONFIGURATION | VOLTAGE | LOCKING BLADE (L) | SINGLE FLIP LID | DUPLEX FLIP LID | FLIP LID WITH MALE RECEPTACLE | CONNECTOR FOR FLIP LID WITH MALE RECEPTACLE |
|---------------|---------|-------------------|-----------------|-----------------|-------------------------------|---|
| NEMA L2-20    | 250V    | ●                 | 67W07           | 67W07DPLX       | 66W07                         | 27W07MB                                     |

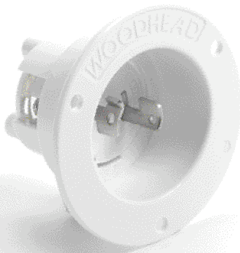

SAFEWAY® FLANGED INLET

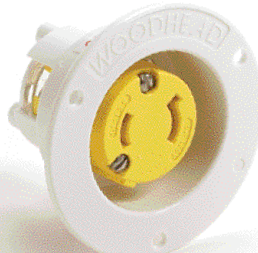

SAFEWAY® FLANGED RECEPTACLE

### Safeway® Receptacles and Inlets

| CONFIGURATION | VOLTAGE | LOCKING BLADE (L) | FLANGED INLET | FLANGED RECEPTACLE |
|---------------|---------|-------------------|---------------|--------------------|
| NEMA L2-20    | 250V    | ●                 | 2607MB        | 2707MB             |



MOST WOODHEAD PRODUCTS HAVE U.L. AND/OR CSA APPROVALS.  
FOR A LISTING OF APPROVALS BY PART NUMBER, SEE PAGES 262-269.

WATERTITE® PLUGS  
AND CONNECTORS  
AVAILABLE (SEE PAGE 68)

**20 AMP CORDSETS**

- 250V – 2-Pole, 2-Wire – NEMA L2-20

Factory pre-made Watertite® or Super-Safeway® cordsets are made from heavy-duty SOW cord and the appropriate connector bodies that fit your environment. Product photos are intended to show style only and are not intended to reflect indicated configurations.



WATERTITE® CORDSET

**Watertite® Cordsets**

| CONFIGURATION | VOLTAGE | 14-GAUGE SOW CORDSETS | 12-GAUGE SOW CORDSETS |
|---------------|---------|-----------------------|-----------------------|
| NEMA L2-20 ☺☺ | 250V    | 26W07_142             | 26W07_122             |

**Super-Safeway® Cordsets**

| CONFIGURATION | VOLTAGE | 14-GAUGE SOW CORDSETS | 12-GAUGE SOW CORDSETS |
|---------------|---------|-----------------------|-----------------------|
| NEMA L2-20 ☺☺ | 250V    | 2607_142              | 2607_122              |

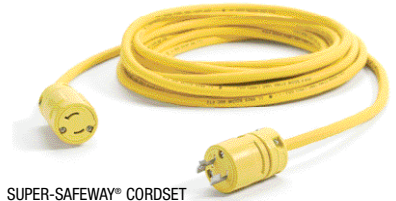

SUPER-SAFEWAY® CORDSET

**Cordset Options:** Use the following chart to modify your part's specifications. 12 & 14 gauge GFCI cordsets use SJOW cord.

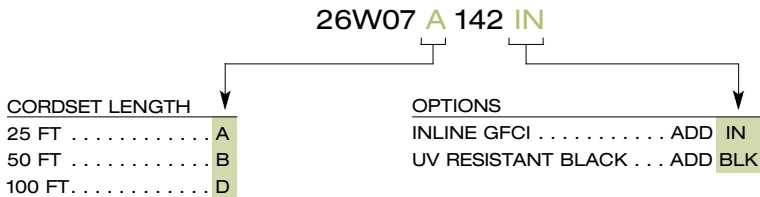

UL SP MOST WOODHEAD PRODUCTS HAVE U.L. AND/OR CSA APPROVALS. FOR A LISTING OF APPROVALS BY PART NUMBER, SEE PAGES 262-269.

## WIRING DEVICES

### 20 AMP PLUGS AND CONNECTORS

- 125V – 2-Pole, 3-Wire – NEMA 5-20 / NEMA L5-20

Watertite® devices set the standard for the roughest, wettest and most abrasive of environments. When properly mated with corresponding connectors, Watertite® devices form an enclosure that meets the requirements of NEMA Type 4, 4X, 6 and 6P, IP65, 66 and 67, and can resist high-pressure hose-down up to 1,000 psi. Additional features include: Unique multiple ring seal that locks snugly, protecting against moisture and contaminants, sturdy compression-type cord grip that provides 205 lbs. of pull-out strength, and a protective closure cap that seals the connector when it is not in use. Product photos are intended to show device style only and are not intended to reflect indicated configurations.

#### Configurations

NEMA 5-20



NEMA L5-20



WATERTITE® CONNECTOR

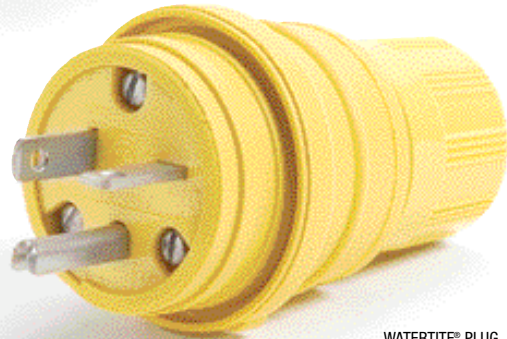

WATERTITE® PLUG

### Watertite® Plugs and Connectors

| CONFIGURATION | VOLTAGE | LOCKING BLADE (L) | PLUG PART NO. <sup>1,2</sup> | CONNECTOR PART NO. <sup>1,2</sup> | CORD GRIP BODY SIZE |
|---------------|---------|-------------------|------------------------------|-----------------------------------|---------------------|
| NEMA 5-20     | 125V    |                   | 14W33                        | 15W33                             | F2 ½"               |
| NEMA L5-20    | 125V    | ●                 | 26W47                        | 27W47                             | F3 ¾"               |

<sup>1</sup> FOR CORD RANGES AND CORD SPECIFICATIONS, SEE PAGE 126.

<sup>2</sup> FOR EXTRA-HARD OUTDOOR USE, ORDER WATERTITE® DEVICES IN UV RESISTANT BLACK. ADD "BLK" TO THE END OF THE PART NUMBER.

RECEPTACLES AVAILABLE  
(SEE PAGES 76-77)

PREMADE CORDSETS  
AVAILABLE  
(SEE PAGES 78-79)



MOST WOODHEAD PRODUCTS HAVE U.L. AND/OR CSA APPROVALS.  
FOR A LISTING OF APPROVALS BY PART NUMBER, SEE PAGES 262-269.



## 20 AMP PLUGS AND CONNECTORS

- 125V – 2-Pole, 3-Wire – NEMA 5-20 / NEMA L5-20

Designed for rugged industrial and commercial use, Super-Safeway® devices share some of the advanced design features of their Watertite® counterparts. Their durable rubber housing resists heat, oil, impact, and chemicals. A patented self-centering cord clamp provides superior strain-relief for a range of cable sizes while speed screws aid in quick assembly of these dead-front back-wired devices pioneered by Woodhead. New Safeway+® wiring devices feature a 3-piece rubberized-nylon assembly that locks the device together with just two screws for quick, easy assembly while providing durability and protection with a rubber-coated nylon design. Safeway® nylon plugs and connectors are Woodhead's economical solution for industrial and commercial applications. Product photos are intended to show device style only and are not intended to reflect indicated configurations.



SUPER-SAFEWAY® PLUG



SUPER-SAFEWAY® CONNECTOR

### Super-Safeway® Plugs and Connectors

| CONFIGURATION | VOLTAGE | LOCKING BLADE (L) | PLUG PART NO. <sup>1,2</sup> | CONNECTOR PART NO. <sup>1,2</sup> |
|---------------|---------|-------------------|------------------------------|-----------------------------------|
| NEMA 5-20     | 125V    |                   | 1433                         | 1533                              |
| NEMA L5-20    | 125V    | ●                 | 2647                         | 2747                              |

SAFEWAY+® PLUG



SAFEWAY+® CONNECTOR

### Safeway+® Plugs and Connectors

| CONFIGURATION | VOLTAGE | PLUG PART NO. <sup>1</sup> | CONNECTOR PART NO. <sup>1</sup> |
|---------------|---------|----------------------------|---------------------------------|
| NEMA 5-20     | 125V    | 5366-RB                    | 5369-RB                         |

SAFEWAY® PLUG



SAFEWAY® CONNECTOR

### Safeway® Plugs and Connectors<sup>3</sup>

| CONFIGURATION | VOLTAGE | LOCKING BLADE (L) | PLUG PART NO. <sup>1</sup> | CONNECTOR PART NO. <sup>1</sup> |
|---------------|---------|-------------------|----------------------------|---------------------------------|
| NEMA 5-20     | 125V    |                   | 5366                       | 5369                            |
| NEMA L5-20    | 125V    | ●                 | 26T47                      | 27T47                           |

<sup>1</sup> FOR CORD RANGES AND CORD SPECIFICATIONS, SEE PAGE 126.

<sup>2</sup> FOR EXTRA-HARD OUTDOOR USE, ORDER SUPER-SAFEWAY® DEVICES IN UV RESISTANT BLACK. ADD "BLK" TO THE END OF THE PART NUMBER.

<sup>3</sup> TO ORDER SAFEWAY® DEVICE IN YELLOW ADD A "YL" SUFFIX TO THE WOODHEAD PART NO.



MOST WOODHEAD PRODUCTS HAVE U.L. AND/OR CSA APPROVALS. FOR A LISTING OF APPROVALS BY PART NUMBER, SEE PAGES 262-269.



## WIRING DEVICES

### 20 AMP SPECIALTY PLUGS AND CONNECTORS

- 125V – 2-Pole, 3-Wire – NEMA 5-20 / NEMA L5-20

Woodhead monitoring plugs and connectors let you determine whether or not a receptacle or extension cord is properly grounded and wired. It is the reliable and convenient way to really put portable hand lamps, power tools, and equipment to the test. The GCM (ground continuity monitor) connector satisfies OSHA's extension cord testing requirements under the Assured Equipment Grounding Conductor Program. When proper continuity of the grounding conductor is sensed, the connector will glow. By not lighting, the GCM connector alerts the user that there is a problem. The monitoring plug indicates that a receptacle is properly grounded and wired when its bright LED shines continuously.

WATERTITE® GROUND CONTINUITY  
SAFE-T-CHECK® MONITORING PLUG



#### Configurations

NEMA 5-20



NEMA L5-20



### Watertite® Monitoring Plugs and Connectors for ground continuity

| CONFIGURATION   | VOLTAGE | LOCKING BLADE (L) | PLUG PART NO. | CONNECTOR PART NO. | CORD GRIP BODY SIZE |
|---|---------|-------------------|---------------|--------------------|---------------------|
| NEMA 5-20  | 125V    |                   | 14W33EZ       | 15W33GCM           | F2 1/2"             |

SUPER-SAFEWAY® MONITORING PLUG



SUPER-SAFEWAY® GROUND  
CONTINUITY MONITOR

### Super-Safeway® Monitoring Plugs and Connectors

| CONFIGURATION   | VOLTAGE | LOCKING BLADE (L) | PLUG PART NO. | CONNECTOR PART NO. |
|---|---------|-------------------|---------------|--------------------|
| NEMA 5-20  | 125V    |                   | 1433EZ        | 1533GCM            |



MOST WOODHEAD PRODUCTS HAVE U.L. AND/OR CSA APPROVALS.  
FOR A LISTING OF APPROVALS BY PART NUMBER, SEE PAGES 262-269.

**20 AMP SPECIALTY PLUGS AND CONNECTORS**

- 125V – 2-Pole, 3-Wire – NEMA 5-20 / NEMA L5-20



BLACK PLUG



YELLOW PLUG



BLACK CONNECTOR

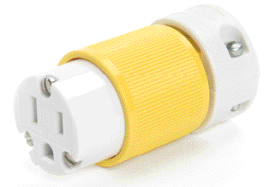

YELLOW CONNECTOR

**Safeway® Hospital Duty Plugs and Connectors**

| CONFIGURATION | VOLTAGE | PLUG PART NO. <sup>1</sup> |         |             |          | CONNECTOR PART NO. <sup>1</sup> |         |
|---------------|---------|----------------------------|---------|-------------|----------|---------------------------------|---------|
|               |         | BLACK                      | YELLOW  | TRANSPARENT | ORANGE   | BLACK                           | YELLOW  |
| NEMA 5-20     | 125V    | 85366                      | 85366YL | 85433       | 85366ORG | 85369                           | 85369YL |

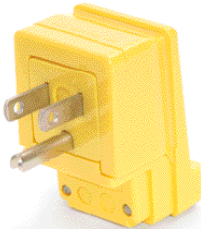

YELLOW RIGHT ANGLE PLUGS



TRANSPARENT RIGHT ANGLE PLUGS

**Safeway® Right Angle Plugs**

| CONFIGURATION | VOLTAGE | PLUG PART NO. <sup>1</sup> |                            |
|---------------|---------|----------------------------|----------------------------|
|               |         | YELLOW                     | HOSPITAL GRADE TRANSPARENT |
| NEMA 5-20     | 125V    | 14R33                      | 85053                      |



LIGHTED DEVICES – PLUG



LIGHTED DEVICES – CONNECTOR

**Safeway® Lighted Plugs and Connectors**

| CONFIGURATION | VOLTAGE | PLUG PART NO. | CONNECTOR PART NO. |
|---------------|---------|---------------|--------------------|
| NEMA 5-20     | 125V    | 85433L        | 5369L              |

<sup>1</sup> FOR CORD RANGES AND CORD SPECIFICATIONS, SEE PAGE 126.

## WIRING DEVICES

### 20 AMP RECEPTACLES

- 125V – 2-Pole, 3-Wire – NEMA 5-20 / NEMA L5-20

Woodhead meets your receptacle needs head-on. Single, duplex or motor-base receptacles for wet abusive environments are covered by Watertite® product solutions while general industrial applications are well served by nylon Safeway® receptacles. Watertite® receptacles feature spring-loaded flip lid covers with built-in lock-out/tag-out capabilities and the patented triple seal for the best in wet-location protection. Product photos are intended to show device style only and are not intended to reflect indicated configurations.

#### Configurations

NEMA 5-20



NEMA L5-20



WATERTITE® SINGLE FLIP LID



WATERTITE® DUPLEX FLIP LID

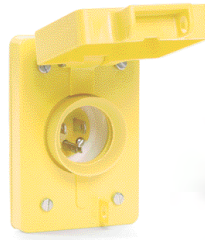



WATERTITE® FLIP LID  
W/ MALE RECEPTACLE





WATERTITE® CONNECTOR FOR  
FLIP LID W/ MALE RECEPTACLE

### Watertite® Receptacles with Flip Coverplates

| CONFIGURATION  | VOLTAGE | LOCKING BLADE (L) | SINGLE FLIP LID | DUPLEX FLIP LID | FLIP LID WITH MALE RECEPTACLE | CONNECTOR FOR FLIP LID WITH MALE RECEPTACLE |
|--|---------|-------------------|-----------------|-----------------|-------------------------------|---|
| NEMA 5-20    | 125V    |                   | 60W33           | 60W33DPLX       | 59W33                         | 15W33MB                                     |
| NEMA L5-20  | 125V    | ●                 | 67W47           | —               | 66W47                         | 27W47MB                                     |

### Watertite® Single & Duplex GFCI Receptacle

| CONFIGURATION  | VOLTAGE | TYPE   | RECEPTACLE PART NO. |
|--|---------|--------|---------------------|
| NEMA 5-20   | 125V    | DUPLEX | 60W33DPLXGF         |
| NEMA L5-20  | 125V    | SINGLE | 67W47GF             |





WATERTITE® DUPLEX  
GFCI RECEPTACLE



WATERTITE® SINGLE  
GFCI RECEPTACLE

### Watertite® Pigtail Outlet

| CONFIGURATION   | VOLTAGE | OUTLET PART NO. |
|---|---------|-----------------|
| NEMA 5-20  | 125V    | 633             |

  MOST WOODHEAD PRODUCTS HAVE U.L. AND/OR CSA APPROVALS.  
FOR A LISTING OF APPROVALS BY PART NUMBER, SEE PAGES 262-269.

WATERTITE® PLUGS  
AND CONNECTORS  
AVAILABLE (SEE PAGE 72)

**20 AMP RECEPTACLES**

- 125V – 2-Pole, 3-Wire – NEMA 5-20 / NEMA L5-20

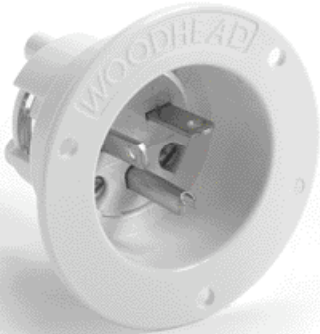

SAFEWAY® FLANGED INLET

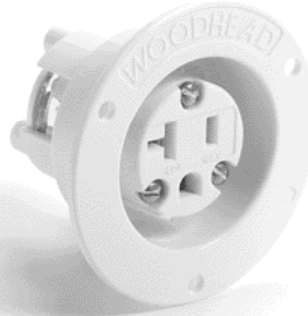

SAFEWAY® FLANGED RECEPTACLE

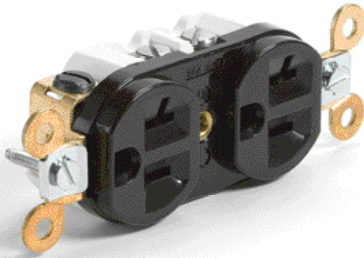

SAFEWAY® DUPLEX RECEPTACLE

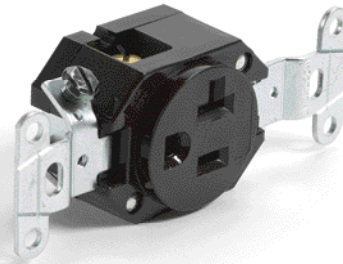

SAFEWAY® SINGLE RECEPTACLE

Safeway® Receptacles and Inlets

| CONFIGURATION | VOLTAGE | LOCKING BLADE (L) | FLANGED INLET | FLANGED RECEPTACLE | SINGLE RECEPTACLE                     | DUPLEX RECEPTACLE       |                         |
|---------------|---------|-------------------|---------------|--------------------|---------------------------------------|-------------------------|-------------------------|
|               |         |                   |               |                    | HEAVY DUTY, SPEC GRADE <sup>1,2</sup> | SPEC GRADE <sup>3</sup> | HEAVY DUTY <sup>3</sup> |
| NEMA 5-20     | 125V    |                   | 1433MB        | 1533MB             | 5361DW <sup>1,2</sup>                 | 5352DW                  | 5362DW                  |
| NEMA L5-20    | 125V    | ●                 | 2647MB        | 2747MB             | 4747                                  | —                       | —                       |

<sup>1</sup> STANDARD COLOR IS BLACK

<sup>2</sup> FOR CORROSION-RESISTANT RECEPTACLE, ADD "CR" SUFFIX TO THE PART NO. (E.G. 4949CR)

<sup>3</sup> STANDARD COLOR IS BROWN



MOST WOODHEAD PRODUCTS HAVE U.L. AND/OR CSA APPROVALS. FOR A LISTING OF APPROVALS BY PART NUMBER, SEE PAGES 262-269.

# WIRING DEVICES

## 20 AMP CORDSETS

- 125V – 2-Pole, 3-Wire – NEMA 5-20 / NEMA L5-20

Factory pre-made Watertite® or Super-Safeway® cordsets are made from heavy-duty SOW cord and the appropriate connector bodies that fit your environment. Product photos are intended to show style only and are not intended to reflect indicated configurations.

### Configurations

NEMA 5-20





NEMA L5-20





WATERTITE® CORDSET



### Watertite® Cordsets

| CONFIGURATION  | VOLTAGE | 14-GAUGE SOW CORDSETS | 12-GAUGE SOW CORDSETS |
|--|---------|-----------------------|-----------------------|
| NEMA 5-20   | 125V    | 14W33_143             | 14W33_123             |
| NEMA L5-20  | 125V    | 26W47_143             | 26W47_123             |

### Super-Safeway® Cordsets

| CONFIGURATION  | VOLTAGE | 14-GAUGE SOW CORDSETS | 12-GAUGE SOW CORDSETS |
|--|---------|-----------------------|-----------------------|
| NEMA 5-20   | 125V    | 1433_143              | 1433_123              |
| NEMA L5-20  | 125V    | 2647_143              | 2647_123              |



SUPER-SAFEWAY® CORDSET

**Cordset Options:** Use the following chart to modify your part's specifications. 12 & 14 gauge GFCI cordsets use SJOW cord.

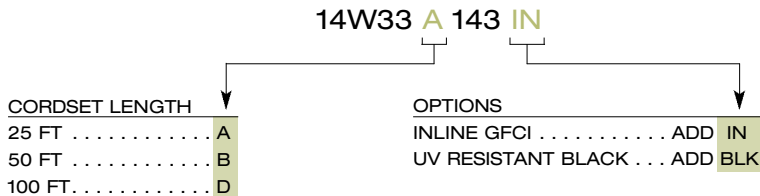

**20 AMP SPECIALTY CORDSETS**

- 125V – 2-Pole, 3-Wire – NEMA 5-20 / NEMA L5-20

Molded “Y” and “W” cordsets are high quality, custom-made adapters that provide multiple outlets from a single source. They are made from heavy-duty SOW cord and the appropriate connector bodies that fit your environment. When ordering custom cordsets, the amperage and voltage of the plug must be equal to or greater than that of the connectors. Approximate overall length of the product is 3 ft. Product photos are intended to show device style only and are not intended to reflect indicated configurations.



WATERTITE® MOLDED Y CORDSET



WATERTITE® MOLDED W CORDSET

**Watertite® Molded Cordsets**

| CONFIGURATION | VOLTAGE | MOLDED Y CORDSET |                                | MOLDED W CORDSET |                                |
|---------------|---------|------------------|--------------------------------|------------------|--------------------------------|
|               |         | STANDARD         | WITH IN-LINE GFCI <sup>1</sup> | STANDARD         | WITH IN-LINE GFCI <sup>1</sup> |
| NEMA 5-20     | 125V    | 14W33-Y          | 14W33-Y-IN                     | 14W33-W          | 14W33-W-IN                     |
| NEMA L5-20    | 125V    | 26W47-Y          | 26W47-Y-IN                     | 26W47-W          | 26W47-W-IN                     |

<sup>1</sup> IN-LINE GFCI CORDSETS USE SJOW CORD.



MOLDED Y CORDSET



MOLDED W CORDSET

**Super Safeway® Molded Cordsets**

| CONFIGURATION | VOLTAGE | MOLDED Y CORDSET |                                | MOLDED W CORDSET |                                |
|---------------|---------|------------------|--------------------------------|------------------|--------------------------------|
|               |         | STANDARD         | WITH IN-LINE GFCI <sup>1</sup> | STANDARD         | WITH IN-LINE GFCI <sup>1</sup> |
| NEMA 5-20     | 125V    | 1433-Y           | 1433-Y-IN                      | 1433-W           | 1433-W-IN                      |
| NEMA L5-20    | 125V    | 2647-Y           | 2647-Y-IN                      | 2647-W           | 2647-W-IN                      |

<sup>1</sup> IN-LINE GFCI CORDSETS USE SJOW CORD.



MOST WOODHEAD PRODUCTS HAVE U.L. AND/OR CSA APPROVALS. FOR A LISTING OF APPROVALS BY PART NUMBER, SEE PAGES 262-269.



## WIRING DEVICES

### 20 AMP PLUGS AND CONNECTORS

- 125V/250V – 3-Pole, 3-Wire – Non-NEMA
- 250V Grounding Tab – 3-Pole, 3-Wire – Non-NEMA Locking
- 120V/208V – 4-Pole, 4-Wire – Non-NEMA Locking
- 20A/250V, 10A/600V – 4-Pole, 5-Wire – Non-NEMA Locking

Watertite® devices set the standard for the roughest, wettest and most abrasive of environments. When properly mated with corresponding connectors, Watertite® devices form an enclosure that meets the requirements of NEMA Type 4, 4X, 6 and 6P, IP65, 66 and 67, and can resist high-pressure hose-down up to 1,000 psi. Additional features include: Unique multiple ring seal that locks snugly, protecting against moisture and contaminants, sturdy compression-type cord grip that provides 205 lbs. of pull-out strength, and a protective closure cap that seals the connector when it is not in use. Product photos are intended to show device style only and are not intended to reflect indicated configurations.

#### Configurations

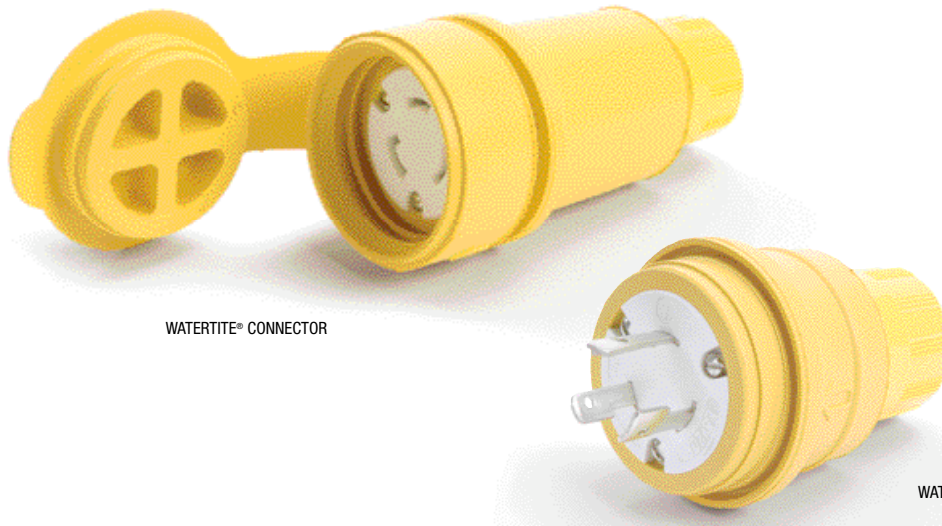
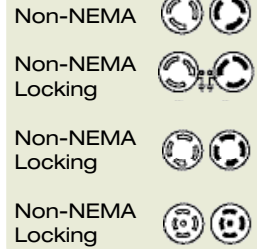

WATERTITE® CONNECTOR

WATERTITE® PLUG

### Watertite® Plugs and Connectors

| CONFIGURATION    | VOLTAGE            | LOCKING BLADE (L) | PLUG PART NO. <sup>1,2</sup> | CONNECTOR PART NO. <sup>1,2</sup> | CORD GRIP BODY SIZE |
|------------------|--------------------|-------------------|------------------------------|-----------------------------------|---------------------|
| NON-NEMA         | 125/250V           | ●                 | 26W08                        | 27W08                             | F3 ¾"               |
| NON-NEMA LOCKING | 250V GRNDING TAB   | ●                 | 26W08G                       | 27W08G                            | F3 ¾"               |
| NON-NEMA LOCKING | 120/208V           | ●                 | 26W09                        | 27W09                             | F4 1"               |
| NON-NEMA LOCKING | 20A/250V, 10A/600V | ●                 | 26W10                        | 27W10                             | F4 1"               |

<sup>1</sup> FOR CORD RANGES AND CORD SPECIFICATIONS, SEE PAGE 126.

<sup>2</sup> FOR EXTRA-HARD OUTDOOR USE, ORDER WATERTITE® DEVICES IN UV RESISTANT BLACK. ADD "BLK" TO THE END OF THE PART NUMBER.

WATERTITE® RECEPTACLES  
AVAILABLE (SEE PAGE 82)

PREMADE CORDSETS  
AVAILABLE (SEE PAGE 83)

MOST WOODHEAD PRODUCTS HAVE U.L. AND/OR CSA APPROVALS.  
FOR A LISTING OF APPROVALS BY PART NUMBER, SEE PAGES 262-269.

## 20 AMP PLUGS AND CONNECTORS

- 125V/250V – 3-Pole, 3-Wire – Non-NEMA
- 250V Grounding Tab – 3-Pole, 3-Wire – Non-NEMA Locking
- 120V/208V – 4-Pole, 4-Wire – Non-NEMA Locking
- 20A/250V, 10A/600V – 4-Pole, 5-Wire – Non-NEMA Locking

Designed for rugged industrial and commercial use, Super-Safeway® devices share some of the advanced design features of their Watertite® counterparts. Their durable rubber housing resists heat, oil, impact, and chemicals. A patented self-centering cord clamp provides superior strain-relief for a range of cable sizes while speed screws aid in quick assembly of these dead-front back-wired devices pioneered by Woodhead. New Safeway+® wiring devices feature a 3-piece rubberized-nylon assembly that locks the device together with just two screws for quick, easy assembly while providing durability and protection with a rubber-coated nylon design. Safeway® nylon plugs and connectors are Woodhead's economical solution for industrial and commercial applications. Product photos are intended to show device style only and are not intended to reflect indicated configurations.

SUPER-SAFEWAY® PLUG

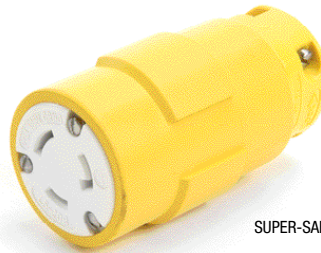
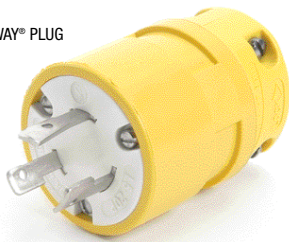

SUPER-SAFEWAY® CONNECTOR

### Super-Safeway® Plugs and Connectors

| CONFIGURATION    | VOLTAGE            | LOCKING BLADE (L) | PLUG PART NO. <sup>1,2</sup> | CONNECTOR PART NO. <sup>1,2</sup> |
|------------------|--------------------|-------------------|------------------------------|-----------------------------------|
| NON-NEMA         | 125/250V           | ●                 | 2608                         | 2708                              |
| NON-NEMA LOCKING | 250V GRNDING TAB   | ●                 | 2608G                        | 2708G                             |
| NON-NEMA LOCKING | 120/208V           | ●                 | 2609                         | 2709                              |
| NON-NEMA LOCKING | 20A/250V, 10A/600V | ●                 | 2610                         | 2710                              |

SAFEWAY® PLUG



SAFEWAY® CONNECTOR

### Safeway® Plugs and Connectors<sup>3</sup>

| CONFIGURATION    | VOLTAGE            | LOCKING BLADE (L) | PLUG PART NO. <sup>1</sup> | CONNECTOR PART NO. <sup>1</sup> |
|------------------|--------------------|-------------------|----------------------------|---------------------------------|
| NON-NEMA         | 125/250V           | ●                 | 26T08                      | 27T08                           |
| NON-NEMA LOCKING | 250V GRNDING TAB   | ●                 | 26T08G                     | 27T08G                          |
| NON-NEMA LOCKING | 120/208V           | ●                 | 26T09                      | 27T09                           |
| NON-NEMA LOCKING | 20A/250V, 10A/600V | ●                 | 26T10                      | 27T10                           |

<sup>1</sup> FOR CORD RANGES AND CORD SPECIFICATIONS, SEE PAGE 126.

<sup>2</sup> FOR EXTRA-HARD OUTDOOR USE, ORDER SUPER-SAFEWAY® DEVICES IN UV RESISTANT BLACK. ADD "BLK" TO THE END OF THE PART NUMBER.

<sup>3</sup> TO ORDER SAFEWAY® DEVICE IN YELLOW ADD A "YL" SUFFIX TO THE WOODHEAD PART NO.



MOST WOODHEAD PRODUCTS HAVE U.L. AND/OR CSA APPROVALS. FOR A LISTING OF APPROVALS BY PART NUMBER, SEE PAGES 262-269.

## WIRING DEVICES

### 20 AMP RECEPTACLES

- 125V/250V – 3-Pole, 3-Wire – Non-NEMA
- 250V Grounding Tab – 3-Pole, 3-Wire – Non-NEMA Locking
- 120V/208V – 4-Pole, 4-Wire – Non-NEMA Locking
- 20A/250V, 10A/600V – 4-Pole, 5-Wire – Non-NEMA Locking

Woodhead meets your receptacle needs head-on. Single, duplex or motor-base receptacles for wet abusive environments are covered by Watertite® product solutions while general industrial applications are well served by nylon Safeway® receptacles. Watertite® receptacles feature spring-loaded flip lid covers with built-in lock-out/tag-out capabilities and the patented triple seal for the best in wet-location protection. Product photos are intended to show device style only and are not intended to reflect indicated configurations.

#### Configurations

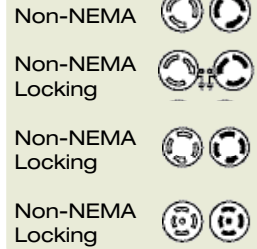

WATERTITE® SINGLE FLIP LID



WATERTITE® FLIP LID  
W/ MALE RECEPTACLE



WATERTITE® CONNECTOR FOR  
FLIP LID W/ MALE RECEPTACLE

### Watertite® Receptacles with Flip Coverplates

| CONFIGURATION    | VOLTAGE              | LOCKING BLADE (L) | SINGLE FLIP LID | FLIP LID WITH MALE RECEPTACLE | CONNECTOR FOR FLIP LID WITH MALE RECEPTACLE |
|------------------|----------------------|-------------------|-----------------|-------------------------------|---|
| NON-NEMA         | 125/250V             | ●                 | 67W08           | 66W08                         | 27W08MB                                     |
| NON-NEMA LOCKING | 125/250V GRNDING TAB | ●                 | —               | —                             | 27W08GOB                                    |
| NON-NEMA LOCKING | 120/208V             | ●                 | 67W09           | 66W09                         | 27W09MB                                     |
| NON-NEMA LOCKING | 20A/250V, 10A/600V   | ●                 | 67W10           | 66W10                         | 27W10MB                                     |

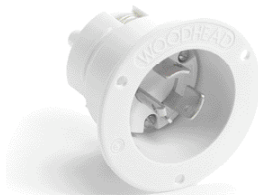

SAFEWAY® FLANGED INLET



SAFEWAY® FLANGED RECEPTACLE

### Safeway® Receptacles and Inlets

| CONFIGURATION    | VOLTAGE              | LOCKING BLADE (L) | FLANGED INLET | FLANGED RECEPTACLE |
|------------------|----------------------|-------------------|---------------|--------------------|
| NON-NEMA         | 125/250V             | ●                 | 2608MB        | 2708MB             |
| NON-NEMA LOCKING | 125/250V GRNDING TAB | ●                 | —             | —                  |
| NON-NEMA LOCKING | 120/208V             | ●                 | 2609MB        | 2709MB             |
| NON-NEMA LOCKING | 20A/250V, 10A/600V   | ●                 | 2610MB        | 2710MB             |



MOST WOODHEAD PRODUCTS HAVE U.L. AND/OR CSA APPROVALS.  
FOR A LISTING OF APPROVALS BY PART NUMBER, SEE PAGES 262-269.

**20 AMP CORDSETS**



- 125V/250V – 3-Pole, 3-Wire – Non-NEMA
- 120V/208V – 4-Pole, 4-Wire – Non-NEMA Locking

Factory pre-made Watertite® or Super-Safeway® cordsets are made from heavy-duty SOW cord and the appropriate connector bodies that fit your environment. Product photos are intended to show style only and are not intended to reflect indicated configurations.





WATERTITE® CORDSET

**Watertite® Cordsets**

| CONFIGURATION  | VOLTAGE  | 14-GAUGE SOW CORDSETS | 12-GAUGE SOW CORDSETS |
|--|----------|-----------------------|-----------------------|
| NON-NEMA          | 125/250V | 26W08_143             | 26W08_123             |
| NON-NEMA LOCKING  | 120/208V | 26W09_144             | 26W09_124             |

**Super-Safeway® Cordsets**

| CONFIGURATION  | VOLTAGE  | 14-GAUGE SOW CORDSETS | 12-GAUGE SOW CORDSETS |
|--|----------|-----------------------|-----------------------|
| NON-NEMA          | 125/250V | 2608_143              | 2608_123              |
| NON-NEMA LOCKING  | 120/208V | 2609_144              | 2609_124              |



SUPER-SAFEWAY® CORDSET

**Cordset Options:** Use the following chart to modify your part's specifications. 12 & 14 gauge GFCI cordsets use SJOW cord.

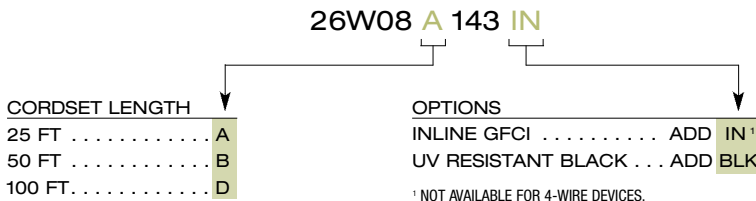

 MOST WOODHEAD PRODUCTS HAVE U.L. AND/OR CSA APPROVALS. FOR A LISTING OF APPROVALS BY PART NUMBER, SEE PAGES 262-269.

## WIRING DEVICES

### 20 AMP PLUGS AND CONNECTORS

- 250V – 2-Pole, 3-Wire – NEMA 6-20 / NEMA L6-20
- 277V – 2-Pole, 3-Wire – NEMA L7-20

Watertite® devices set the standard for the roughest, wettest and most abrasive of environments. When properly mated with corresponding connectors, Watertite® devices form an enclosure that meets the requirements of NEMA Type 4, 4X, 6 and 6P, IP65, 66 and 67, and can resist high-pressure hose-down up to 1,000 psi. Additional features include: Unique multiple ring seal that locks snugly, protecting against moisture and contaminants, sturdy compression-type cord grip that provides 205 lbs. of pull-out strength, and a protective closure cap that seals the connector when it is not in use. Product photos are intended to show device style only and are not intended to reflect indicated configurations.

#### Configurations

NEMA 6-20



NEMA L6-20



NEMA L7-20



WATERTITE® CONNECTOR

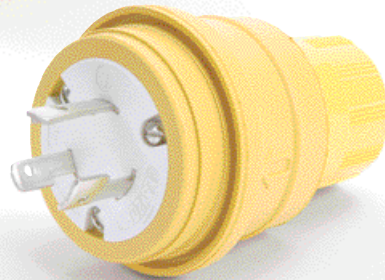

WATERTITE® PLUG

### Watertite® Plugs and Connectors

| CONFIGURATION | VOLTAGE | LOCKING BLADE (L) | PLUG PART NO. <sup>1,2</sup> | CONNECTOR PART NO. <sup>1,2</sup> | CORD GRIP BODY SIZE |
|---------------|---------|-------------------|------------------------------|-----------------------------------|---------------------|
| NEMA 6-20     | 250V    |                   | 14W48                        | 15W48                             | F2 ½"               |
| NEMA L6-20    | 250V    | ●                 | 26W48                        | 27W48                             | F3 ¾"               |
| NEMA L7-20    | 277V    | ●                 | 26W49                        | 27W49                             | F3 ¾"               |

<sup>1</sup> FOR CORD RANGES AND CORD SPECIFICATIONS, SEE PAGE 126.

<sup>2</sup> FOR EXTRA-HARD OUTDOOR USE, ORDER WATERTITE® DEVICES IN UV RESISTANT BLACK. ADD "BLK" TO THE END OF THE PART NUMBER.

WATERTITE® RECEPTACLES  
AVAILABLE (SEE PAGE 86)

PREMADE CORDSETS  
AVAILABLE (SEE PAGE 87)

 MOST WOODHEAD PRODUCTS HAVE U.L. AND/OR CSA APPROVALS.  
FOR A LISTING OF APPROVALS BY PART NUMBER, SEE PAGES 262-269.



**20 AMP PLUGS AND CONNECTORS**

- 250V – 2-Pole, 3-Wire – NEMA 6-20 / NEMA L6-20
- 277V – 2-Pole, 3-Wire – NEMA L7-20

Designed for rugged industrial and commercial use, Super-Safeway® devices share some of the advanced design features of their Watertite® counterparts. Their durable rubber housing resists heat, oil, impact, and chemicals. A patented self-centering cord clamp provides superior strain-relief for a range of cable sizes while speed screws aid in quick assembly of these dead-front back-wired devices pioneered by Woodhead. New Safeway+® wiring devices feature a 3-piece rubberized-nylon assembly that locks the device together with just two screws for quick, easy assembly while providing durability and protection with a rubber-coated nylon design. Safeway® nylon plugs and connectors are Woodhead's economical solution for industrial and commercial applications. Product photos are intended to show device style only and are not intended to reflect indicated configurations.

SUPER-SAFEWAY® PLUG

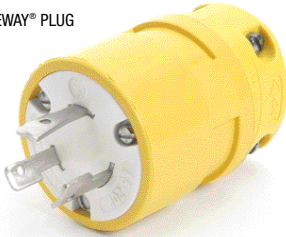

SUPER-SAFEWAY® CONNECTOR

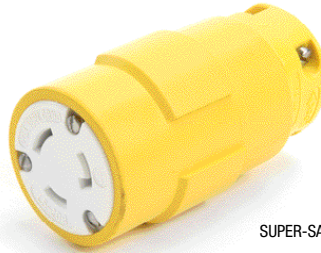

**Super-Safeway® Plugs and Connectors**

| CONFIGURATION | VOLTAGE | LOCKING BLADE (L) | PLUG PART NO. <sup>1,2</sup> | CONNECTOR PART NO. <sup>1,2</sup> |
|---------------|---------|-------------------|------------------------------|-----------------------------------|
| NEMA 6-20     | 250V    |                   | 1448                         | 1548                              |
| NEMA L6-20    | 250V    | ●                 | 2648                         | 2748                              |
| NEMA L7-20    | 277V    | ●                 | 2649                         | 2749                              |

SAFEWAY® PLUG



SAFEWAY® CONNECTOR



**Safeway® Plugs and Connectors<sup>3</sup>**

| CONFIGURATION | VOLTAGE | LOCKING BLADE (L) | PLUG PART NO. <sup>1</sup> | CONNECTOR PART NO. <sup>1</sup> |
|---------------|---------|-------------------|----------------------------|---------------------------------|
| NEMA 6-20     | 250V    |                   | 5466                       | 5469                            |
| NEMA L6-20    | 250V    | ●                 | 26T48                      | 27T48                           |
| NEMA L7-20    | 277V    | ●                 | 26T49                      | 27T49                           |

<sup>1</sup> FOR CORD RANGES AND CORD SPECIFICATIONS, SEE PAGE 126.

<sup>2</sup> FOR EXTRA-HARD OUTDOOR USE, ORDER SUPER-SAFEWAY® DEVICES IN UV RESISTANT BLACK. ADD "BLK" TO THE END OF THE PART NUMBER.

<sup>3</sup> TO ORDER SAFEWAY® DEVICE IN YELLOW ADD A "YL" SUFFIX TO THE WOODHEAD PART NO.



## WIRING DEVICES

### 20 AMP RECEPTACLES

- 250V – 2-Pole, 3-Wire – NEMA 6-20 / NEMA L6-20
- 277V – 2-Pole, 3-Wire – NEMA L7-20

Woodhead meets your receptacle needs head-on. Single, duplex or motor-base receptacles for wet abusive environments are covered by Watertite® product solutions while general industrial applications are well served by nylon Safeway® receptacles. Watertite® receptacles feature spring-loaded flip lid covers with built-in lock-out/tag-out capabilities and the patented triple seal for the best in wet-location protection. Product photos are intended to show device style only and are not intended to reflect indicated configurations.

#### Configurations



WATERTITE® SINGLE FLIP LID



WATERTITE® DUPLEX FLIP LID



WATERTITE® FLIP LID  
W/ MALE RECEPTACLE



WATERTITE® CONNECTOR FOR  
FLIP LID W/ MALE RECEPTACLE

### Watertite® Receptacles with Flip Coverplates

| CONFIGURATION | VOLTAGE | LOCKING BLADE (L) | SINGLE FLIP LID | DUPLEX FLIP LID | FLIP LID WITH MALE RECEPTACLE | CONNECTOR FOR FLIP LID WITH MALE RECEPTACLE |
|---------------|---------|-------------------|-----------------|-----------------|-------------------------------|---|
| NEMA 6-20     | 250V    | ●                 | 60W48           | 60W48DPLX       | 59W48                         | 15W48MB                                     |
| NEMA L6-20    | 250V    | ●                 | 67W48           | —               | 66W48                         | 27W48MB                                     |
| NEMA L7-20    | 277V    | ●                 | 67W49           | —               | 66W49                         | 27W49MB                                     |

### Watertite® Pigtail Outlet

| CONFIGURATION | VOLTAGE | OUTLET PART NO. |
|---------------|---------|-----------------|
| NEMA 6-20     | 250V    | 648             |



SAFEWAY® FLANGED INLET



SAFEWAY® FLANGED RECEPTACLES



SAFEWAY® DUPLEX RECEPTACLE



SAFEWAY® SINGLE RECEPTACLE

### Safeway® Receptacles and Inlets

| CONFIGURATION | VOLTAGE | LOCKING BLADE (L) | FLANGED INLET | FLANGED RECEPTACLE | SINGLE RECEPTACLE                     |                         | DUPLEX RECEPTACLE       |                         |
|---------------|---------|-------------------|---------------|--------------------|---------------------------------------|-------------------------|-------------------------|-------------------------|
|               |         |                   |               |                    | HEAVY DUTY, SPEC GRADE <sup>1,2</sup> | SPEC GRADE <sup>3</sup> | SPEC GRADE <sup>3</sup> | HEAVY DUTY <sup>3</sup> |
| NEMA 6-20     | 250V    | ●                 | 1448MB        | 1548MB             | —                                     | 5452DW                  | 5462DW                  |                         |
| NEMA L6-20    | 250V    | ●                 | 2648MB        | 2748MB             | 4748                                  | —                       | —                       |                         |
| NEMA L7-20    | 277V    | ●                 | 2649MB        | 2749MB             | 4749                                  | —                       | —                       |                         |

<sup>1</sup> STANDARD COLOR IS BLACK

<sup>2</sup> FOR CORROSION-RESISTANT RECEPTACLE, ADD "CR" SUFFIX TO THE PART NO. (E.G. 4949CR)

<sup>3</sup> STANDARD COLOR IS BROWN



MOST WOODHEAD PRODUCTS HAVE U.L. AND/OR CSA APPROVALS. FOR A LISTING OF APPROVALS BY PART NUMBER, SEE PAGES 262-269.

WATERTITE® PLUGS AND CONNECTORS AVAILABLE (SEE PAGE 84)

Configurations

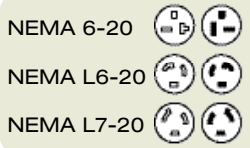

**20 AMP CORDSETS & SPECIALTY CORDSETS**

- 250V – 2-Pole, 3-Wire – NEMA 6-20 / NEMA L6-20
- 277V – 2-Pole, 3-Wire – NEMA L7-20

Factory pre-made Watertite® or Super-Safeway® cordsets are made from heavy-duty SOW cord and the appropriate connector bodies that fit your environment. Product photos are intended to show style only and are not intended to reflect indicated configurations.

**Watertite® Cordsets**

| CONFIGURATION | VOLTAGE | 14-GAUGE SOW CORDSETS | 12-GAUGE SOW CORDSETS |
|---------------|---------|-----------------------|-----------------------|
| NEMA 6-20     | 250V    | 14W48_143             | 14W48_123             |
| NEMA L6-20    | 250V    | 26W48_143             | 26W48_123             |
| NEMA L7-20    | 277V    | 26W49_143             | 26W49_123             |



WATERTITE® CORDSET

**Super-Safeway® Cordsets**

| CONFIGURATION | VOLTAGE | 14-GAUGE SOW CORDSETS | 12-GAUGE SOW CORDSETS |
|---------------|---------|-----------------------|-----------------------|
| NEMA 6-20     | 250V    | 1448_143              | 1448_123              |
| NEMA L6-20    | 250V    | 2648_143              | 2648_123              |
| NEMA L7-20    | 277V    | 2649_143              | 2649_123              |



SUPER-SAFEWAY® CORDSET

**Cordset Options:** Use the following chart to modify your part's specifications. 12 & 14 gauge GFCI cordsets use SJOW cord.

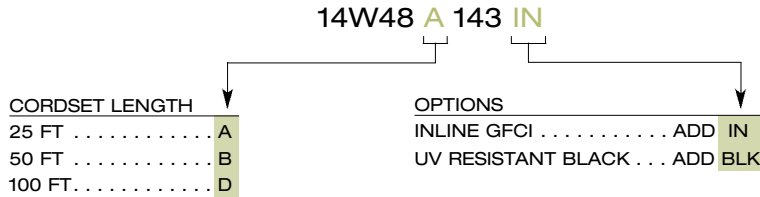

WATERTITE® MOLDED Y CORDSET



WATERTITE® MOLDED W CORDSET



MOLDED Y CORDSET



MOLDED W CORDSET

**Watertite® Molded Cordsets**

| CONFIGURATION | VOLTAGE | MOLDED Y CORDSET |                                | MOLDED W CORDSET |                                |
|---------------|---------|------------------|--------------------------------|------------------|--------------------------------|
|               |         | STANDARD         | WITH IN-LINE GFCI <sup>1</sup> | STANDARD         | WITH IN-LINE GFCI <sup>1</sup> |
| NEMA 6-20     | 250V    | 14W48-Y          | 14W48-Y-IN                     | 14W48-W          | 14W48-W-IN                     |

**Super Safeway® Molded Cordsets**

| CONFIGURATION | VOLTAGE | MOLDED Y CORDSET |                                | MOLDED W CORDSET |                                |
|---------------|---------|------------------|--------------------------------|------------------|--------------------------------|
|               |         | STANDARD         | WITH IN-LINE GFCI <sup>1</sup> | STANDARD         | WITH IN-LINE GFCI <sup>1</sup> |
| NEMA 6-20     | 250V    | 1448-Y           | 1448-Y-IN                      | 1448-W           | 1448-W-IN                      |

<sup>1</sup> IN-LINE GFCI CORDSETS USE SJOW CORD.

UL SP MOST WOODHEAD PRODUCTS HAVE U.L. AND/OR CSA APPROVALS. FOR A LISTING OF APPROVALS BY PART NUMBER, SEE PAGES 262-269.

## WIRING DEVICES

### 20 AMP PLUGS AND CONNECTORS

- 125V/250V – 3-Pole, 4-Wire – NEMA L14-20
- 250V – 3-Pole, 4-Wire, 3 $\phi$  – NEMA L15-20
- 480V – 3-Pole, 4-Wire, 3 $\phi$  – NEMA L16-20

Watertite® devices set the standard for the roughest, wettest and most abrasive of environments. When properly mated with corresponding connectors, Watertite® devices form an enclosure that meets the requirements of NEMA Type 4, 4X, 6 and 6P, IP65, 66 and 67, and can resist high-pressure hose-down up to 1,000 psi. Additional features include: Unique multiple ring seal that locks snugly, protecting against moisture and contaminants, sturdy compression-type cord grip that provides 205 lbs. of pull-out strength, and a protective closure cap that seals the connector when it is not in use. Product photos are intended to show device style only and are not intended to reflect indicated configurations.

#### Configurations

NEMA L14-20 

NEMA L15-20 

NEMA L16-20 



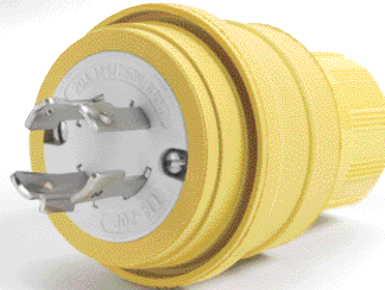

WATERTITE® CONNECTOR



WATERTITE® PLUG

### Watertite® Plugs and Connectors

| CONFIGURATION   | VOLTAGE        | LOCKING BLADE (L) | PLUG PART NO. <sup>1,2</sup> | CONNECTOR PART NO. <sup>1,2</sup> | CORD GRIP BODY SIZE |
|---|----------------|-------------------|------------------------------|-----------------------------------|---------------------|
| NEMA L14-20  | 125V/250V      | ●                 | 26W74                        | 27W74                             | F3 ¾"               |
| NEMA L15-20  | 250V, 3 $\phi$ | ●                 | 26W75                        | 27W75                             | F3 ¾"               |
| NEMA L16-20  | 480V, 3 $\phi$ | ●                 | 26W76                        | 27W76                             | F3 ¾"               |

<sup>1</sup> FOR CORD RANGES AND CORD SPECIFICATIONS, SEE PAGE 126.

<sup>2</sup> FOR EXTRA-HARD OUTDOOR USE, ORDER WATERTITE® DEVICES IN UV RESISTANT BLACK. ADD "BLK" TO THE END OF THE PART NUMBER.

WATERTITE® RECEPTACLES  
AVAILABLE (SEE PAGE 90)

PREMADE CORDSETS  
AVAILABLE (SEE PAGE 91)



MOST WOODHEAD PRODUCTS HAVE U.L. AND/OR CSA APPROVALS.  
FOR A LISTING OF APPROVALS BY PART NUMBER, SEE PAGES 262-269.

**20 AMP PLUGS AND CONNECTORS**

- 125V/250V – 3-Pole, 4-Wire – NEMA L14-20
- 250V – 3-Pole, 4-Wire, 3Ø – NEMA L15-20
- 480V – 3-Pole, 4-Wire, 3Ø – NEMA L16-20

Designed for rugged industrial and commercial use, Super-Safeway® devices share some of the advanced design features of their Watertite® counterparts. Their durable rubber housing resists heat, oil, impact, and chemicals. A patented self-centering cord clamp provides superior strain-relief for a range of cable sizes while speed screws aid in quick assembly of these dead-front back-wired devices pioneered by Woodhead. New Safeway+® wiring devices feature a 3-piece rubberized-nylon assembly that locks the device together with just two screws for quick, easy assembly while providing durability and protection with a rubber-coated nylon design. Safeway® nylon plugs and connectors are Woodhead's economical solution for industrial and commercial applications. Product photos are intended to show device style only and are not intended to reflect indicated configurations.

SUPER-SAFEWAY® PLUG

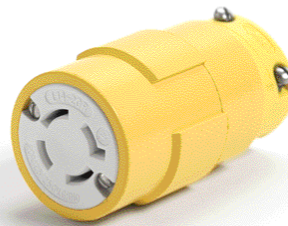
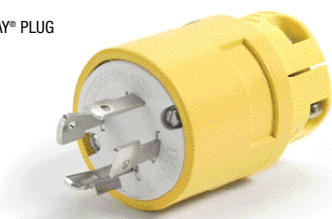

SUPER-SAFEWAY® CONNECTOR

**Super-Safeway® Plugs and Connectors**

| CONFIGURATION | VOLTAGE   | LOCKING BLADE (L) | PLUG PART NO. <sup>1,2</sup> | CONNECTOR PART NO. <sup>1,2</sup> |
|---------------|-----------|-------------------|------------------------------|-----------------------------------|
| NEMA L14-20   | 125V/250V |                   | 2674                         | 2774                              |
| NEMA L15-20   | 250V, 3Ø  |                   | 2675                         | 2775                              |
| NEMA L16-20   | 480V, 3Ø  |                   | 2676                         | 2776                              |

SAFEWAY® PLUG

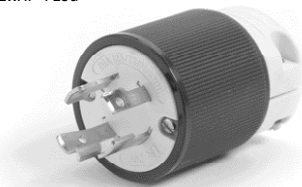

SAFEWAY® CONNECTOR

**Safeway® Plugs and Connectors<sup>3</sup>**

| CONFIGURATION | VOLTAGE   | LOCKING BLADE (L) | PLUG PART NO. <sup>1</sup> | CONNECTOR PART NO. <sup>1</sup> |
|---------------|-----------|-------------------|----------------------------|---------------------------------|
| NEMA L14-20   | 125V/250V |                   | 26T74                      | 27T74                           |
| NEMA L15-20   | 250V, 3Ø  |                   | 26T75                      | 27T75                           |
| NEMA L16-20   | 480V, 3Ø  |                   | 26T76                      | 27T76                           |

<sup>1</sup> FOR CORD RANGES AND CORD SPECIFICATIONS, SEE PAGE 126.

<sup>2</sup> FOR EXTRA-HARD OUTDOOR USE, ORDER SUPER-SAFEWAY® DEVICES IN UV RESISTANT BLACK. ADD "BLK" TO THE END OF THE PART NUMBER.

<sup>3</sup> TO ORDER SAFEWAY® DEVICE IN YELLOW ADD A "YL" SUFFIX TO THE WOODHEAD PART NO.

## WIRING DEVICES

### 20 AMP RECEPTACLES

- 125V/250V – 3-Pole, 4-Wire – NEMA L14-20
- 250V – 3-Pole, 4-Wire, 3 $\phi$  – NEMA L15-20
- 480V – 3-Pole, 4-Wire, 3 $\phi$  – NEMA L16-20

Woodhead meets your receptacle needs head-on. Single, duplex or motor-base receptacles for wet abusive environments are covered by Watertite® product solutions while general industrial applications are well served by nylon Safeway® receptacles. Watertite® receptacles feature spring-loaded flip lid covers with built-in lock-out/tag-out capabilities and the patented triple seal for the best in wet-location protection. Product photos are intended to show device style only and are not intended to reflect indicated configurations.

#### Configurations

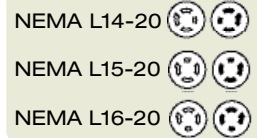

WATERTITE® SINGLE FLIP LID



WATERTITE® FLIP LID  
W/ MALE RECEPTACLE



WATERTITE® CONNECTOR FOR  
FLIP LID W/ MALE RECEPTACLE

### Watertite® Receptacles with Flip Coverplates

| CONFIGURATION | VOLTAGE        | LOCKING BLADE (L) | SINGLE FLIP LID | FLIP LID WITH MALE RECEPTACLE | CONNECTOR FOR FLIP LID WITH MALE RECEPTACLE |
|---------------|----------------|-------------------|-----------------|-------------------------------|---|
| NEMA L14-20   | 125V/250V      | ●                 | 67W74           | 66W74                         | 27W74MB                                     |
| NEMA L15-20   | 250V, 3 $\phi$ | ●                 | 67W75           | 66W75                         | 27W75MB                                     |
| NEMA L16-20   | 480V, 3 $\phi$ | ●                 | 67W76           | 66W76                         | 27W76MB                                     |



SAFEWAY® FLANGED INLET



SAFEWAY® FLANGED RECEPTACLE



SAFEWAY® SINGLE RECEPTACLE

### Safeway® Receptacles and Inlets

| CONFIGURATION | VOLTAGE        | LOCKING BLADE (L) | FLANGED RECEPTACLE | FLANGED RECEPTACLE | SINGLE RECEPTACLE <sup>1</sup> |
|---------------|----------------|-------------------|--------------------|--------------------|--------------------------------|
| NEMA L14-20   | 125V/250V      | ●                 | 2674MB             | 2774MB             | 4774                           |
| NEMA L15-20   | 250V, 3 $\phi$ | ●                 | 2675MB             | 2775MB             | 4775                           |
| NEMA L16-20   | 480V, 3 $\phi$ | ●                 | 2676MB             | 2776MB             | 4776                           |

<sup>1</sup> FOR CORROSION-RESISTANT RECEPTACLE ADD "CR" SUFFIX TO THE WOODHEAD PART NO.

UL SP MOST WOODHEAD PRODUCTS HAVE U.L. AND/OR CSA APPROVALS.  
FOR A LISTING OF APPROVALS BY PART NUMBER, SEE PAGES 262-269.

WATERTITE® PLUGS  
AND CONNECTORS  
AVAILABLE (SEE PAGE 88)

**20 AMP CORDSETS**

- 125V/250V – 3-Pole, 4-Wire - NEMA L14-20
- 250V – 3-Pole, 4-Wire, 3ø – NEMA L15-20
- 480V – 3-Pole, 4-Wire, 3ø – NEMA L16-20

Factory pre-made Watertite® or Super-Safeway® cordsets are made from heavy-duty SOW cord and the appropriate connector bodies that fit your environment. Product photos are intended to show style only and are not intended to reflect indicated configurations.



WATERTITE® CORDSET

**Watertite® Cordsets**

| CONFIGURATION  | VOLTAGE   | 14-GAUGE SOW CORDSETS | 12-GAUGE SOW CORDSETS |
|----------------|-----------|-----------------------|-----------------------|
| NEMA L14-20 ☺☺ | 125V/250V | 26W74_144             | 26W74_124             |
| NEMA L15-20 ☺☺ | 250V, 3ø  | 26W75_144             | 26W75_124             |
| NEMA L16-20 ☺☺ | 480V, 3ø  | 26W76_144             | 26W76_124             |

**Super-Safeway® Cordsets**

| CONFIGURATION  | VOLTAGE   | 16-GAUGE SOW CORDSETS | 14-GAUGE SOW CORDSETS |
|----------------|-----------|-----------------------|-----------------------|
| NEMA L14-20 ☺☺ | 125V/250V | 2674_144              | 2674_124              |
| NEMA L15-20 ☺☺ | 250V, 3ø  | 2675_144              | 2675_124              |
| NEMA L16-20 ☺☺ | 480V, 3ø  | 2676_144              | 2676_124              |



SUPER-SAFEWAY® CORDSET

**Cordset Options:** Use the following chart to modify your part's specifications.

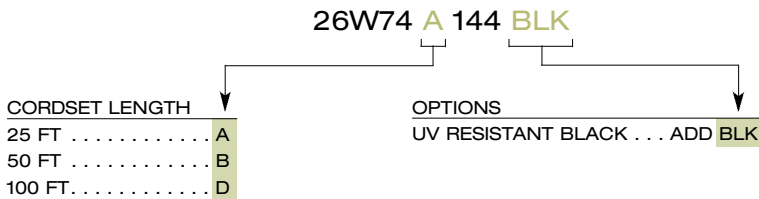

MOST WOODHEAD PRODUCTS HAVE U.L. AND/OR CSA APPROVALS. FOR A LISTING OF APPROVALS BY PART NUMBER, SEE PAGES 262-269.



## WIRING DEVICES

### 20 AMP/3 PHASE PLUGS AND CONNECTORS

- 120V/208V – 4-Pole, 5-Wire, 3 $\phi$  – NEMA L21-20
- 277V/480V – 4-Pole, 5-Wire, 3 $\phi$  – NEMA L22-20
- 347V/600V – 4-Pole, 5-Wire, 3 $\phi$  – NEMA L23-20

Watertite® devices set the standard for the roughest, wettest and most abrasive of environments. When properly mated with corresponding connectors, Watertite® devices form an enclosure that meets the requirements of NEMA Type 4, 4X, 6 and 6P, IP65, 66 and 67, and can resist high-pressure hose-down up to 1,000 psi. Additional features include: unique multiple ring seal that locks snugly, protecting against moisture and contaminants, sturdy compression-type cord grip that provides 205 lbs. of pull-out strength, and a protective closure cap that seals the connector when it is not in use. Product photos are intended to show device style only and are not intended to reflect indicated configurations.

#### Configurations

NEMA L21-20



NEMA L22-20



NEMA L23-20



WATERTITE® CONNECTOR



WATERTITE® PLUG

### Watertite® Plugs and Connectors

| CONFIGURATION |  | VOLTAGE            | LOCKING BLADE (L) | PLUG PART NO. <sup>1,2</sup> | CONNECTOR PART NO. <sup>1,2</sup> | CORD GRIP BODY SIZE |
|---------------|--|--------------------|-------------------|------------------------------|-----------------------------------|---------------------|
| NEMA L21-20   |  | 120/208V, 3 $\phi$ | ●                 | 26W81                        | 27W81                             | F3 3/4"             |
| NEMA L22-20   |  | 277/480V, 3 $\phi$ | ●                 | 26W82                        | 27W82                             | F3 3/4"             |
| NEMA L23-20   |  | 347/600V, 3 $\phi$ | ●                 | 26W83                        | 27W83                             | F3 3/4"             |

<sup>1</sup> FOR CORD RANGES AND CORD SPECIFICATIONS, SEE PAGE 126.

<sup>2</sup> FOR EXTRA-HARD OUTDOOR USE, ORDER WATERTITE® DEVICES IN UV RESISTANT BLACK. ADD "BLK" TO THE END OF THE PART NO.

WATERTITE® RECEPTACLES  
AVAILABLE (SEE PAGE 94)

PREMADE CORDSETS  
AVAILABLE (SEE PAGE 95)



MOST WOODHEAD PRODUCTS HAVE U.L. AND/OR CSA APPROVALS.  
FOR A LISTING OF APPROVALS BY PART NUMBER, SEE PAGES 262-269.

## 20 AMP/3 PHASE PLUGS AND CONNECTORS

- 120V/208V – 4-Pole, 5-Wire, 3ø – NEMA L21-20
- 277V/480V – 4-Pole, 5-Wire, 3ø – NEMA L22-20
- 347V/600V – 4-Pole, 5-Wire, 3ø – NEMA L23-20

Designed for rugged industrial and commercial use, Super-Safeway® devices share some of the advanced design features of their Watertite® counterparts. Their durable rubber housing resists heat, oil, impact, and chemicals. A patented self-centering cord clamp provides superior strain-relief for a range of cable sizes while speed screws aid in quick assembly of these dead-front back-wired devices pioneered by Woodhead. Safeway® nylon plugs and connectors are Woodhead's economical solution for industrial and commercial applications. Product photos are intended to show device style only and are not intended to reflect indicated configurations.

SUPER-SAFEWAY® PLUG

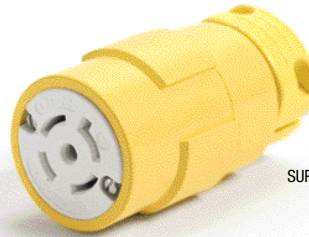
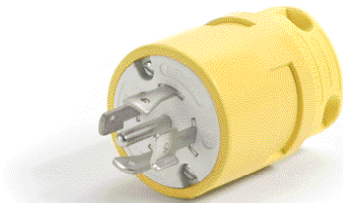

SUPER-SAFEWAY® CONNECTOR

### Super-Safeway® Plugs and Connectors

| CONFIGURATION | VOLTAGE      | LOCKING BLADE (L) | PLUG PART NO. <sup>1,2</sup> | CONNECTOR PART NO. <sup>1,2</sup> |
|---------------|--------------|-------------------|------------------------------|-----------------------------------|
| NEMA L21-20   | 120/208V, 3ø | ●                 | 2681                         | 2781                              |
| NEMA L22-20   | 277/480V, 3ø | ●                 | 2682                         | 2782                              |
| NEMA L23-20   | 347/600V, 3ø | ●                 | 2683                         | 2783                              |

SAFEWAY® PLUG



SAFEWAY® CONNECTOR

### Safeway® Plugs and Connectors<sup>3</sup>

| CONFIGURATION | VOLTAGE      | LOCKING BLADE (L) | PLUG PART NO. <sup>1</sup> | CONNECTOR PART NO. <sup>1</sup> |
|---------------|--------------|-------------------|----------------------------|---------------------------------|
| NEMA L21-20   | 120/208V, 3ø | ●                 | 26T81                      | 27T81                           |
| NEMA L22-20   | 277/480V, 3ø | ●                 | 26T82                      | 27T82                           |
| NEMA L23-20   | 347/600V, 3ø | ●                 | 26T83                      | 27T83                           |

<sup>1</sup> FOR CORD RANGES AND CORD SPECIFICATIONS, SEE PAGE 126.

<sup>2</sup> FOR EXTRA-HARD OUTDOOR USE, ORDER SUPER-SAFEWAY® DEVICES IN UV RESISTANT BLACK. ADD "BLK" TO THE END OF THE PART NO.

<sup>3</sup> TO ORDER SAFEWAY® DEVICE IN YELLOW ADD A "YL" SUFFIX TO THE WOODHEAD PART NO.



MOST WOODHEAD PRODUCTS HAVE U.L. AND/OR CSA APPROVALS. FOR A LISTING OF APPROVALS BY PART NUMBER, SEE PAGES 262-269.

## WIRING DEVICES

### 20 AMP/3 PHASE RECEPTACLES

- 120V/208V – 4-Pole, 5-Wire, 3 $\phi$  – NEMA L21-20
- 277V/480V – 4-Pole, 5-Wire, 3 $\phi$  – NEMA L22-20
- 347V/600V – 4-Pole, 5-Wire, 3 $\phi$  – NEMA L23-20

Woodhead meets your receptacle needs head-on. Single, duplex or motor-base receptacles for wet abusive environments are covered by Watertite<sup>®</sup> product solutions while general industrial applications are well served by nylon Safeway<sup>®</sup> receptacles. Watertite<sup>®</sup> receptacles feature spring-loaded flip lid covers with built-in lock-out/tag-out capabilities and the patented triple seal for the best in wet-location protection. Product photos are intended to show device style only and are not intended to reflect indicated configurations.

#### Configurations

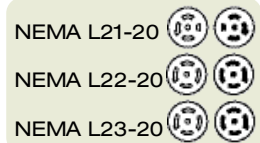

WATERTITE<sup>®</sup> SINGLE FLIP LID



WATERTITE<sup>®</sup> FLIP LID  
W/ MALE RECEPTACLE



WATERTITE<sup>®</sup> CONNECTOR FOR  
FLIP LID W/ MALE RECEPTACLE

### Watertite<sup>®</sup> Receptacles with Flip Coverplates

| CONFIGURATION | VOLTAGE            | LOCKING BLADE (L) | SINGLE FLIP LID | FLIP LID WITH MALE RECEPTACLE | CONNECTOR FOR FLIP LID WITH MALE RECEPTACLE |
|---------------|--------------------|-------------------|-----------------|-------------------------------|---|
| NEMA L21-20   | 120/208V, 3 $\phi$ | ●                 | 67W81           | 66W81                         | 27W81MB                                     |
| NEMA L22-20   | 277/480V, 3 $\phi$ | ●                 | 67W82           | 66W82                         | 27W82MB                                     |
| NEMA L23-20   | 347/600V, 3 $\phi$ | ●                 | 67W83           | 66W83                         | 27W83MB                                     |



SAFEWAY<sup>®</sup> FLANGED INLET

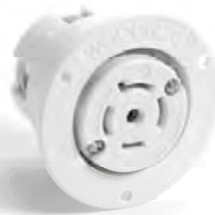

SAFEWAY<sup>®</sup> FLANGED RECEPTACLES

### Safeway<sup>®</sup> Receptacles and Inlets

| CONFIGURATION | VOLTAGE            | LOCKING BLADE (L) | FLANGED INLET | FLANGED RECEPTACLES |
|---------------|--------------------|-------------------|---------------|---------------------|
| NEMA L21-20   | 120/208V, 3 $\phi$ | ●                 | 2681MB        | 2781MB              |
| NEMA L22-20   | 277/480V, 3 $\phi$ | ●                 | 2682MB        | 2782MB              |
| NEMA L23-20   | 347/600V, 3 $\phi$ | ●                 | 2683MB        | 2783MB              |



MOST WOODHEAD PRODUCTS HAVE U.L. AND/OR CSA APPROVALS.  
FOR A LISTING OF APPROVALS BY PART NUMBER, SEE PAGES 262-269.

WATERTITE PLUGS &  
CONNECTORS AVAILABLE  
(SEE PAGE 92)

**20 AMP 3 PHASE CORDSETS**

- 120V/208V – 4-Pole, 5-Wire, 3ø – NEMA L21-20
- 277V/480V – 4-Pole, 5-Wire, 3ø – NEMA L22-20
- 347V/600V – 4-Pole, 5-Wire, 3ø – NEMA L23-20

Factory pre-made Watertite® or Super-Safeway® cordsets are made from heavy-duty SOW cord and the appropriate connector bodies that fit your environment. Product photos are intended to show style only and are not intended to reflect indicated configurations.

WATERTITE® CORDSET



**Watertite® Cordsets**

| CONFIGURATION | VOLTAGE      | 12-GAUGE SOW CORDSETS |
|---------------|--------------|-----------------------|
| NEMA L21-20   | 120/208V, 3ø | 26W81_125             |
| NEMA L22-20   | 277/480V, 3ø | 26W82_125             |
| NEMA L23-20   | 347/600V, 3ø | 26W83_125             |

**Super-Safeway® Cordsets**

| CONFIGURATION | VOLTAGE      | 12-GAUGE SOW CORDSETS |
|---------------|--------------|-----------------------|
| NEMA L21-20   | 120/208V, 3ø | 2681_125              |
| NEMA L22-20   | 277/480V, 3ø | 2682_125              |
| NEMA L23-20   | 347/600V, 3ø | 2683_125              |



SUPER-SAFEWAY® CORDSET

**Cordset Options:** Use the following chart to modify your part's specifications.

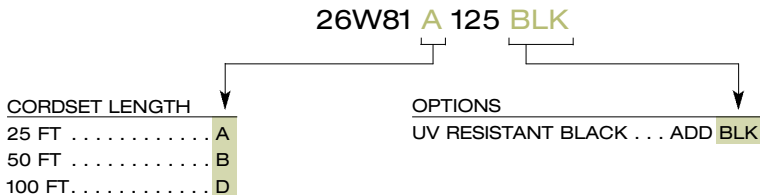

UL SP MOST WOODHEAD PRODUCTS HAVE U.L. AND/OR CSA APPROVALS. FOR A LISTING OF APPROVALS BY PART NUMBER, SEE PAGES 262-269.

## WIRING DEVICES

### 30 AMP PLUGS AND CONNECTORS

- 125V – 2-Pole, 3-Wire – NEMA L5-30
- 250V – 2-Pole, 3-Wire – NEMA L6-30
- 277V – 2-Pole, 3-Wire – NEMA L7-30

Watertite® devices set the standard for the roughest, wettest and most abrasive of environments. When properly mated with corresponding connectors, Watertite® devices form an enclosure that meets the requirements of NEMA Type 4, 4X, 6 and 6P, IP65, 66 and 67, and can resist high-pressure hose-down up to 1,000 psi. Additional features include: unique multiple ring seal that locks snugly, protecting against moisture and contaminants, sturdy compression-type cord grip that provides 205 lbs. of pull-out strength, and a protective closure cap that seals the connector when it is not in use. Product photos are intended to show device style only and are not intended to reflect indicated configurations.

#### Configurations

NEMA L5-30



NEMA L6-30



NEMA L7-30



WATERTITE® CONNECTOR

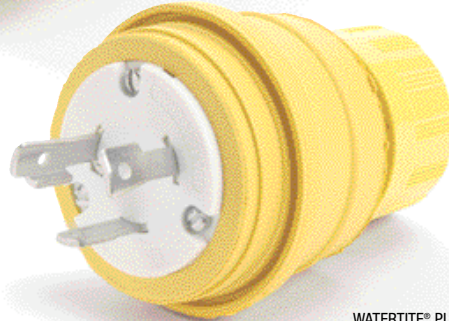

WATERTITE® PLUG

### Watertite® Plugs and Connectors

| CONFIGURATION | VOLTAGE | LOCKING BLADE (L) | PLUG PART NO. <sup>1,2</sup> | CONNECTOR PART NO. <sup>1,2</sup> | CORD GRIP BODY SIZE |
|---------------|---------|-------------------|------------------------------|-----------------------------------|---------------------|
| NEMA L5-30    | 125V    | ●                 | 28W47                        | 29W47                             | F4 1"               |
| NEMA L6-30    | 250V    | ●                 | 28W48                        | 29W48                             | F4 1"               |
| NEMA L7-30    | 277V    | ●                 | 28W49                        | 29W49                             | F4 1"               |

<sup>1</sup> FOR CORD RANGES AND CORD SPECIFICATIONS, SEE PAGE 126.

<sup>2</sup> FOR EXTRA-HARD OUTDOOR USE, ORDER WATERTITE® DEVICES IN UV RESISTANT BLACK. ADD "BLK" TO THE END OF THE PART NUMBER.

WATERTITE® RECEPTACLES  
AVAILABLE (SEE PAGE 98)

PREMADE CORDSETS  
AVAILABLE (SEE PAGE 99)



MOST WOODHEAD PRODUCTS HAVE U.L. AND/OR CSA APPROVALS.  
FOR A LISTING OF APPROVALS BY PART NUMBER, SEE PAGES 262-269.



### 30 AMP PLUGS AND CONNECTORS

- 125V – 2-Pole, 3-Wire – NEMA L5-30
- 250V – 2-Pole, 3-Wire – NEMA L6-30
- 277V – 2-Pole, 3-Wire – NEMA L7-30

Designed for rugged industrial and commercial use, Super-Safeway® devices share some of the advanced design features of their Watertite® counterparts. Their durable rubber housing resists heat, oil, impact, and chemicals. A patented self-centering cord clamp provides superior strain-relief for a range of cable sizes while speed screws aid in quick assembly of these dead-front back-wired devices pioneered by Woodhead. Safeway® nylon plugs and connectors are Woodhead's economical solution for industrial and commercial applications. Product photos are intended to show device style only and are not intended to reflect indicated configurations.

SUPER-SAFEWAY® PLUG



SUPER-SAFEWAY® CONNECTOR

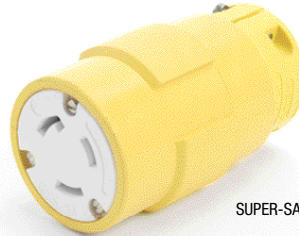

### Super-Safeway® Plugs and Connectors

| CONFIGURATION | VOLTAGE | LOCKING BLADE (L) | PLUG PART NO. <sup>1,2</sup> | CONNECTOR PART NO. <sup>1,2</sup> |
|---------------|---------|-------------------|------------------------------|-----------------------------------|
| NEMA L5-30    | 125V    | ●                 | 2847                         | 2947                              |
| NEMA L6-30    | 250V    | ●                 | 2848                         | 2948                              |
| NEMA L7-30    | 277V    | ●                 | 2849                         | 2949                              |

SAFEWAY® PLUG



SAFEWAY® CONNECTOR



### Safeway® Plugs and Connectors<sup>3</sup>

| CONFIGURATION | VOLTAGE | LOCKING BLADE (L) | PLUG PART NO. <sup>1</sup> | CONNECTOR PART NO. <sup>2</sup> |
|---------------|---------|-------------------|----------------------------|---------------------------------|
| NEMA L5-30    | 125V    | ●                 | 28T47                      | 29T47                           |
| NEMA L6-30    | 250V    | ●                 | 28T48                      | 29T48                           |
| NEMA L7-30    | 277V    | ●                 | 28T49                      | 29T29                           |

<sup>1</sup> FOR CORD RANGES AND CORD SPECIFICATIONS, SEE PAGE 126.

<sup>2</sup> FOR EXTRA-HARD OUTDOOR USE, ORDER SUPER-SAFEWAY® DEVICES IN UV RESISTANT BLACK. ADD "BLK" TO THE END OF THE PART NO.

<sup>3</sup> TO ORDER SAFEWAY® DEVICE IN YELLOW ADD A "YL" SUFFIX TO THE WOODHEAD PART NO.



MOST WOODHEAD PRODUCTS HAVE U.L. AND/OR CSA APPROVALS. FOR A LISTING OF APPROVALS BY PART NUMBER, SEE PAGES 262-269.



## WIRING DEVICES

### 30 AMP RECEPTACLES

- 125V – 2-Pole, 3-Wire – NEMA L5-30
- 250V – 2-Pole, 3-Wire – NEMA L6-30
- 277V – 2-Pole, 3-Wire – NEMA L7-30

Woodhead meets your receptacle needs head-on. Single, duplex or motor-base receptacles for wet abusive environments are covered by Watertite® product solutions while general industrial applications are well served by nylon Safeway® receptacles. Watertite® receptacles feature spring-loaded flip lid covers with built-in lock-out/tag-out capabilities and the patented triple seal for the best in wet-location protection. Product photos are intended to show device style only and are not intended to reflect indicated configurations.

#### Configurations

NEMA L5-30



NEMA L6-30



NEMA L7-30



WATERTITE® SINGLE FLIP LID



WATERTITE® FLIP LID  
W/ MALE RECEPTACLE



WATERTITE® CONNECTOR FOR  
FLIP LID W/ MALE RECEPTACLE

### Watertite® Receptacles with Flip Coverplates

| CONFIGURATION |  | VOLTAGE | LOCKING BLADE (L) | SINGLE FLIP LID | FLIP LID WITH MALE RECEPTACLE | CONNECTOR FOR FLIP LID WITH MALE RECEPTACLE |
|---------------|--|---------|-------------------|-----------------|-------------------------------|---|
| NEMA L5-30    |  | 125V    | ●                 | 69W47           | 68W47                         | 29W47MB                                     |
| NEMA L6-30    |  | 250V    | ●                 | 69W48           | 68W48                         | 29W48MB                                     |
| NEMA L7-30    |  | 277V    | ●                 | 69W49           | 68W49                         | 29W49MB                                     |



SAFEWAY® FLANGED INLET



SAFEWAY® FLANGED RECEPTACLES



SAFEWAY® SINGLE RECEPTACLE

### Safeway® Receptacles and Inlets

| CONFIGURATION |  | VOLTAGE | LOCKING BLADE (L) | FLANGED INLET | FLANGED RECEPTACLES | SINGLE RECEPTACLE <sup>1</sup> |
|---------------|--|---------|-------------------|---------------|---------------------|--------------------------------|
| NEMA L5-30    |  | 125V    | ●                 | 2847MB        | 2947MB              | 4947                           |
| NEMA L6-30    |  | 250V    | ●                 | 2848MB        | 2948MB              | 4948                           |
| NEMA L7-30    |  | 277V    | ●                 | 2849MB        | 2949MB              | 4949                           |

<sup>1</sup> FOR CORROSION RESISTANT RECEPTACLE, ADD "CR" SUFFIX TO PART NO.



MOST WOODHEAD PRODUCTS HAVE U.L. AND/OR CSA APPROVALS.  
FOR A LISTING OF APPROVALS BY PART NUMBER, SEE PAGES 262-269.

WATERTITE® PLUGS &  
CONNECTORS AVAILABLE  
(SEE PAGE 96)

**30 AMP CORDSETS**

- 125V – 2-Pole, 3-Wire – NEMA L5-30
- 250V – 2-Pole, 3-Wire – NEMA L6-30
- 277V – 2-Pole, 3-Wire – NEMA L7-30

Factory pre-made Watertite® or Super-Safeway® cordsets are made from heavy-duty SOW cord and the appropriate connector bodies that fit your environment. Product photos are intended to show style only and are not intended to reflect indicated configurations.

WATERTITE® CORDSET

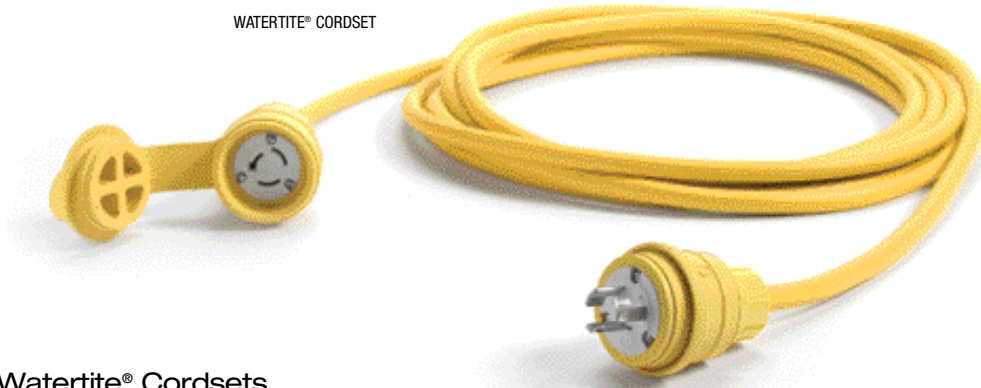

**Watertite® Cordsets**

| CONFIGURATION | VOLTAGE | 12-GAUGE SOW CORDSETS | 10-GAUGE SOW CORDSETS |
|---------------|---------|-----------------------|-----------------------|
| NEMA L5-30    | 125V    | 28W47_123             | 28W47_103             |
| NEMA L6-30    | 250V    | 28W48_123             | 28W48_103             |
| NEMA L7-30    | 277V    | 28W49_123             | 28W49_103             |

**Super-Safeway® Cordsets**

| CONFIGURATION | VOLTAGE | 12-GAUGE SOW CORDSETS | 10-GAUGE SOW CORDSETS |
|---------------|---------|-----------------------|-----------------------|
| NEMA L5-30    | 125V    | 2847_123              | 2847_103              |
| NEMA L6-30    | 250V    | 2848_123              | 2848_103              |
| NEMA L7-30    | 277V    | 2849_123              | 2849_103              |



SUPER-SAFEWAY® CORDSET

**Cordset Options:** Use the following chart to modify your part's specifications. 12 & 14 gauge GFCI cordsets use SJOW cord.

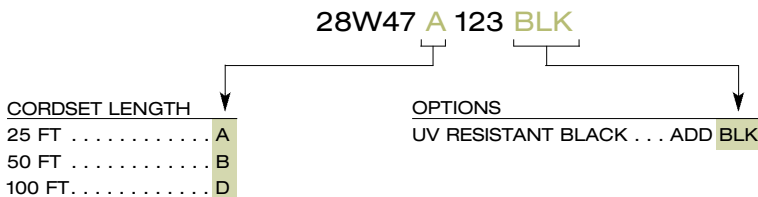

UL SP MOST WOODHEAD PRODUCTS HAVE U.L. AND/OR CSA APPROVALS. FOR A LISTING OF APPROVALS BY PART NUMBER, SEE PAGES 262-269.

## WIRING DEVICES

### 30 AMP PLUGS AND CONNECTORS

- 125V/250V – 3-Pole, 3-Wire – Non-NEMA Locking
- 120V/208V – 4-Pole, 4-Wire – Non-NEMA Locking

Watertite® devices set the standard for the roughest, wettest and most abrasive of environments. When properly mated with corresponding connectors, Watertite® devices form an enclosure that meets the requirements of NEMA Type 4, 4X, 6 and 6P, IP65, 66 and 67, and can resist high-pressure hose-down up to 1,000 psi. Additional features include: unique multiple ring seal that locks snugly, protecting against moisture and contaminants, sturdy compression-type cord grip that provides 205 lbs. of pull-out strength, and a protective closure cap that seals the connector when it is not in use. Product photos are intended to show device style only and are not intended to reflect indicated configurations.

#### Configurations

Non-NEMA Locking



Non-NEMA Locking



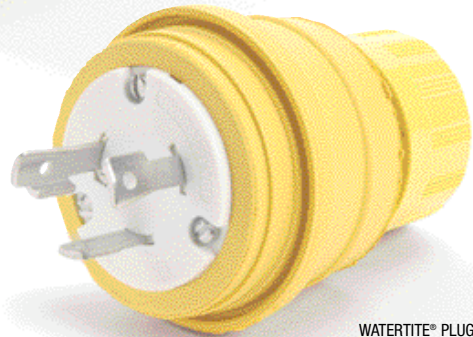

WATERTITE® CONNECTOR



WATERTITE® PLUG

### Watertite® Plugs and Connectors

| CONFIGURATION  | VOLTAGE  | LOCKING BLADE (L) | PLUG PART NO. <sup>1,2</sup> | CONNECTOR PART NO. <sup>1,2</sup> | CORD GRIP BODY SIZE |
|--|----------|-------------------|------------------------------|-----------------------------------|---------------------|
| NON-NEMA LOCKING  | 125/250V | ●                 | 28W08                        | 29W08                             | F4 1"               |
| NON-NEMA LOCKING  | 120/208V | ●                 | 28W09                        | 29W09                             | F4 1"               |

<sup>1</sup> FOR CORD RANGES AND CORD SPECIFICATIONS, SEE PAGE 126.

<sup>2</sup> FOR EXTRA-HARD OUTDOOR USE, ORDER WATERTITE® DEVICES IN UV RESISTANT BLACK. ADD "BLK" TO THE END OF THE PART NUMBER.

WATERTITE® RECEPTACLES  
AVAILABLE (SEE PAGE 102)

PREMADE CORDSETS  
AVAILABLE (SEE PAGE 103)



MOST WOODHEAD PRODUCTS HAVE U.L. AND/OR CSA APPROVALS.  
FOR A LISTING OF APPROVALS BY PART NUMBER, SEE PAGES 262-269.

### 30 AMP PLUGS AND CONNECTORS

- 125V/250V – 3-Pole, 3-Wire – Non-NEMA Locking
- 120V/208V – 4-Pole, 4-Wire – Non-NEMA Locking

Designed for rugged industrial and commercial use, Super-Safeway® devices share some of the advanced design features of their Watertite® counterparts. Their durable rubber housing resists heat, oil, impact, and chemicals. A patented self-centering cord clamp provides superior strain-relief for a range of cable sizes while speed screws aid in quick assembly of these dead-front back-wired devices pioneered by Woodhead. Safeway® nylon plugs and connectors are Woodhead's economical solution for industrial and commercial applications. Product photos are intended to show device style only and are not intended to reflect indicated configurations.

SUPER-SAFEWAY® PLUG

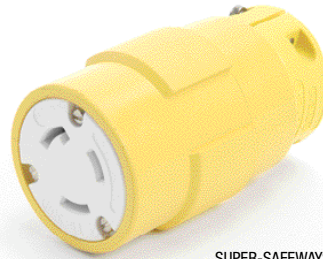
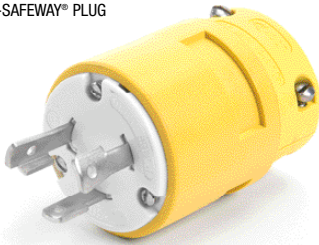

SUPER-SAFEWAY® CONNECTOR

### Super-Safeway® Plugs and Connectors

| CONFIGURATION    | VOLTAGE  | LOCKING BLADE (L) | PLUG PART NO. <sup>1,2</sup> | CONNECTOR PART NO. <sup>1,2</sup> |
|------------------|----------|-------------------|------------------------------|-----------------------------------|
| NON-NEMA LOCKING | 125/250V | ●                 | 2808                         | 2908                              |
| NON-NEMA LOCKING | 120/208V | ●                 | 2809                         | 2909                              |

SAFEWAY® PLUG



SAFEWAY® CONNECTOR

### Safeway® Plugs and Connectors<sup>3</sup>

| CONFIGURATION    | VOLTAGE  | LOCKING BLADE (L) | PLUG PART NO. <sup>1</sup> | CONNECTOR PART NO. <sup>1</sup> |
|------------------|----------|-------------------|----------------------------|---------------------------------|
| NON-NEMA LOCKING | 125/250V | ●                 | 28T08                      | 29T08                           |
| NON-NEMA LOCKING | 120/208V | ●                 | 28T09                      | 29T09                           |

<sup>1</sup> FOR CORD RANGES AND CORD SPECIFICATIONS, SEE PAGE 126.

<sup>2</sup> FOR EXTRA-HARD OUTDOOR USE, ORDER SUPER-SAFEWAY® DEVICES IN UV RESISTANT BLACK. ADD "BLK" TO THE END OF THE PART NO.

<sup>3</sup> TO ORDER SAFEWAY® DEVICE IN YELLOW ADD A "YL" SUFFIX TO THE WOODHEAD PART NO.



MOST WOODHEAD PRODUCTS HAVE U.L. AND/OR CSA APPROVALS. FOR A LISTING OF APPROVALS BY PART NUMBER, SEE PAGES 262-269.

## WIRING DEVICES

### 30 AMP PLUGS AND RECEPTACLES

- 125V/250V – 3-Pole, 3-Wire – Non-NEMA Locking
- 120V/208V – 4-Pole, 4-Wire – Non-NEMA Locking

Woodhead meets your receptacle needs head-on. Single, duplex or motor-base receptacles for wet abusive environments are covered by Watertite® product solutions while general industrial applications are well served by nylon Safeway® receptacles. Watertite® receptacles feature spring-loaded flip lid covers with built-in lock-out/tag-out capabilities and the patented triple seal for the best in wet-location protection. Product photos are intended to show device style only and are not intended to reflect indicated configurations.

#### Configurations

Non-NEMA Locking



Non-NEMA Locking



WATERTITE® SINGLE FLIP LID



WATERTITE® FLIP LID  
W/ MALE RECEPTACLE



WATERTITE® CONNECTOR FOR  
FLIP LID W/ MALE RECEPTACLE

### Watertite® Receptacles with Flip Coverplates

| CONFIGURATION    | VOLTAGE  | LOCKING BLADE (L) | SINGLE FLIP LID | FLIP LID WITH MALE RECEPTACLE | CONNECTOR FOR FLIP LID WITH MALE RECEPTACLE |
|------------------|----------|-------------------|-----------------|-------------------------------|---|
| NON-NEMA LOCKING | 125/250V | ●                 | 69W08           | 68W08                         | 29W08MB                                     |
| NON-NEMA LOCKING | 120/208V | ●                 | 69W09           | 68W09                         | 29W09MB                                     |



SAFEWAY® FLANGED INLET



SAFEWAY® FLANGED RECEPTACLES

### Safeway® Receptacles and Inlets

| CONFIGURATION    | VOLTAGE  | LOCKING BLADE (L) | FLANGED INLET | FLANGED RECEPTACLES |
|------------------|----------|-------------------|---------------|---------------------|
| NON-NEMA LOCKING | 125/250V | ●                 | 2808MB        | 2908MB              |
| NON-NEMA LOCKING | 120/208V | ●                 | 2809MB        | 2909MB              |



MOST WOODHEAD PRODUCTS HAVE U.L. AND/OR CSA APPROVALS.  
FOR A LISTING OF APPROVALS BY PART NUMBER, SEE PAGES 262-269.

WATERTITE® PLUGS &  
CONNECTORS AVAILABLE  
(SEE PAGE 100)



**30 AMP PLUGS AND CORDSETS**

- 125V/250V – 3-Pole, 3-Wire – Non-NEMA Locking
- 120V/208V – 4-Pole, 4-Wire – Non-NEMA Locking

Factory pre-made Watertite® or Super-Safeway® cordsets are made from heavy-duty SOW cord and the appropriate connector bodies that fit your environment. Product photos are intended to show style only and are not intended to reflect indicated configurations.

WATERTITE® CORDSET



**Watertite® Cordsets**

| CONFIGURATION    | VOLTAGE  | 12-GAUGE SOW CORDSETS | 10-GAUGE SOW CORDSETS |
|------------------|----------|-----------------------|-----------------------|
| NON-NEMA LOCKING | 125/250V | 28W08_123             | 28W08_103             |
| NON-NEMA LOCKING | 120/208V | 28W09_124             | 28W09_104             |

**Super-Safeway® Cordsets**

| CONFIGURATION    | VOLTAGE  | 12-GAUGE SOW CORDSETS | 10-GAUGE SOW CORDSETS |
|------------------|----------|-----------------------|-----------------------|
| NON-NEMA LOCKING | 125/250V | 2808_123              | 2808_103              |
| NON-NEMA LOCKING | 120/208V | 2809_124              | 2809_104              |



SUPER-SAFEWAY® CORDSET

**Cordset Options:** Use the following chart to modify your part's specifications. 12 & 14 gauge GFCI cordsets use SJOW cord.



MOST WOODHEAD PRODUCTS HAVE U.L. AND/OR CSA APPROVALS. FOR A LISTING OF APPROVALS BY PART NUMBER, SEE PAGES 262-269.



## WIRING DEVICES

### 30 AMP PLUGS AND CONNECTORS

- 125V/250V – 3-Pole, 4-Wire – NEMA L14-30
- 250V – 3-Pole, 4-Wire, 3 $\phi$  – NEMA L15-30
- 480V – 3-Pole, 4-Wire, 3 $\phi$  – NEMA L16-30
- 600V – 3-Pole, 4-Wire, 3 $\phi$  – NEMA L17-30

Watertite® devices set the standard for the roughest, wettest and most abrasive of environments. When properly mated with corresponding connectors, Watertite® devices form an enclosure that meets the requirements of NEMA Type 4, 4X, 6 and 6P, IP65, 66 and 67, and can resist high-pressure hose-down up to 1,000 psi. Additional features include: unique multiple ring seal that locks snugly, protecting against moisture and contaminants, sturdy compression-type cord grip that provides 205 lbs. of pull-out strength, and a protective closure cap that seals the connector when it is not in use. Product photos are intended to show device style only and are not intended to reflect indicated configurations.

#### Configurations

|             |  |
|-------------|--|
| NEMA L14-30 |  |
| NEMA L15-30 |  |
| NEMA L16-30 |  |
| NEMA L17-30 |  |



WATERTITE® CONNECTOR



WATERTITE® PLUG

### Watertite® Plugs and Connectors

| CONFIGURATION | VOLTAGE        | LOCKING BLADE (L) | PLUG PART NO. <sup>1,2</sup> | CONNECTOR PART NO. <sup>1,2</sup> | CORD GRIP BODY SIZE |
|---------------|----------------|-------------------|------------------------------|-----------------------------------|---------------------|
| NEMA L14-30   | 125V/250V      |                   | 28W74                        | 29W74                             | F4 1"               |
| NEMA L15-30   | 250V, 3 $\phi$ |                   | 28W75                        | 29W75                             | F4 1"               |
| NEMA L16-30   | 480V, 3 $\phi$ |                   | 28W76                        | 29W76                             | F4 1"               |
| NEMA L17-30   | 600V, 3 $\phi$ |                   | 28W77                        | 29W77                             | F4 1"               |

<sup>1</sup> FOR CORD RANGES AND CORD SPECIFICATIONS, SEE PAGE 126.

<sup>2</sup> FOR EXTRA-HARD OUTDOOR USE, ORDER WATERTITE® DEVICES IN UV RESISTANT BLACK. ADD "BLK" TO THE END OF THE PART NUMBER.

WATERTITE® RECEPTACLES  
AVAILABLE (SEE PAGE 106)

PREMADE CORDSETS  
AVAILABLE (SEE PAGE 107)

MOST WOODHEAD PRODUCTS HAVE U.L. AND/OR CSA APPROVALS.  
FOR A LISTING OF APPROVALS BY PART NUMBER, SEE PAGES 262-269.

### 30 AMP PLUGS AND CONNECTORS

- 125V/250V – 3-Pole, 4-Wire – NEMA L14-30
- 250V – 3-Pole, 4-Wire, 3Ø – NEMA L15-30
- 480V – 3-Pole, 4-Wire, 3Ø – NEMA L16-30
- 600V – 3-Pole, 4-Wire, 3Ø – NEMA L17-30

Designed for rugged industrial and commercial use, Super-Safeway® devices share some of the advanced design features of their Watertite® counterparts. Their durable rubber housing resists heat, oil, impact, and chemicals. A patented self-centering cord clamp provides superior strain-relief for a range of cable sizes while speed screws aid in quick assembly of these dead-front back-wired devices pioneered by Woodhead. Safeway® nylon plugs and connectors are Woodhead's economical solution for industrial and commercial applications. Product photos are intended to show device style only and are not intended to reflect indicated configurations.

SUPER-SAFEWAY® PLUG

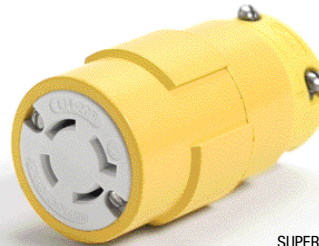
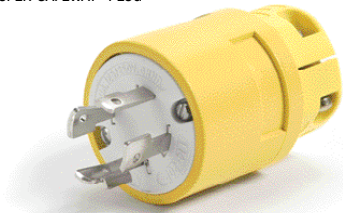

SUPER-SAFEWAY® CONNECTOR

### Super-Safeway® Plugs and Connectors

| CONFIGURATION | VOLTAGE   | LOCKING BLADE (L) | PLUG PART NO. <sup>1,3</sup> | CONNECTOR PART NO. <sup>1,3</sup> |
|---------------|-----------|-------------------|------------------------------|-----------------------------------|
| NEMA L14-30   | 125V/250V | ●                 | 2874                         | 2974                              |
| NEMA L15-30   | 250V, 3Ø  | ●                 | 2875                         | 2975                              |
| NEMA L16-30   | 480V, 3Ø  | ●                 | 2876                         | 2976                              |
| NEMA L17-30   | 600V, 3Ø  | ●                 | 2877                         | 2977                              |

SAFEWAY® PLUG

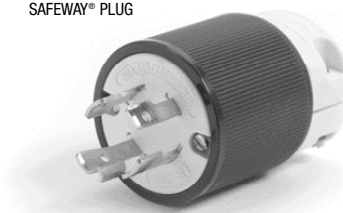

SAFEWAY® CONNECTOR

### Safeway® Plugs and Connectors<sup>3</sup>

| CONFIGURATION | VOLTAGE   | LOCKING BLADE (L) | PLUG PART NO. <sup>1,2</sup> | CONNECTOR PART NO. <sup>1,2</sup> |
|---------------|-----------|-------------------|------------------------------|-----------------------------------|
| NEMA L14-30   | 125V/250V | ●                 | 28T74                        | 29T74                             |
| NEMA L15-30   | 250V, 3Ø  | ●                 | 28T75                        | 29T75                             |
| NEMA L16-30   | 480V, 3Ø  | ●                 | 28T76                        | 29T76                             |
| NEMA L17-30   | 600V, 3Ø  | ●                 | 28T77                        | 29T77                             |

<sup>1</sup> FOR CORD RANGES AND CORD SPECIFICATIONS, SEE PAGE 126.

<sup>2</sup> TO ORDER SAFEWAY® DEVICE IN YELLOW ADD A "YL" SUFFIX TO THE WOODHEAD PART NO.

<sup>3</sup> FOR EXTRA-HARD OUTDOOR USE, ORDER SUPER-SAFEWAY® DEVICES IN UV RESISTANT BLACK. ADD "BLK" TO THE END OF THE PART NO.



MOST WOODHEAD PRODUCTS HAVE U.L. AND/OR CSA APPROVALS. FOR A LISTING OF APPROVALS BY PART NUMBER, SEE PAGES 262-269.

## WIRING DEVICES

### 30 AMP RECEPTACLES

- 125V/250V – 3-Pole, 4-Wire – NEMA L14-30
- 250V – 3-Pole, 4-Wire, 3 $\phi$  – NEMA L15-30
- 480V – 3-Pole, 4-Wire, 3 $\phi$  – NEMA L16-30
- 600V – 3-Pole, 4-Wire, 3 $\phi$  – NEMA L17-30

Woodhead meets your receptacle needs head-on. Single, duplex or motor-base receptacles for wet abusive environments are covered by Watertite® product solutions while general industrial applications are well served by nylon Safeway® receptacles. Watertite® receptacles feature spring-loaded flip lid covers with built-in lock-out/tag-out capabilities and the patented triple seal for the best in wet-location protection. Product photos are intended to show device style only and are not intended to reflect indicated configurations.

#### Configurations

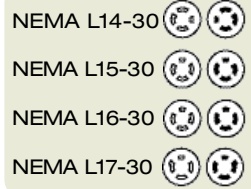

WATERTITE® SINGLE FLIP LID



WATERTITE® FLIP LID  
W/ MALE RECEPTACLE



WATERTITE® CONNECTOR FOR  
FLIP LID W/ MALE RECEPTACLE

### Watertite® Receptacles with Flip Coverplates

| CONFIGURATION | VOLTAGE        | LOCKING BLADE (L) | SINGLE FLIP LID | FLIP LID WITH MALE RECEPTACLE | CONNECTOR FOR FLIP LID WITH MALE RECEPTACLE |
|---------------|----------------|-------------------|-----------------|-------------------------------|---|
| NEMA L14-30   | 125V/250V      | ●                 | 69W74           | 68W74                         | 29W74MB                                     |
| NEMA L15-30   | 250V, 3 $\phi$ | ●                 | 69W75           | 68W75                         | 29W75MB                                     |
| NEMA L16-30   | 480V, 3 $\phi$ | ●                 | 69W76           | 68W76                         | 29W76MB                                     |
| NEMA L17-30   | 600V, 3 $\phi$ | ●                 | 69W77           | 68W77                         | 29W77MB                                     |



SAFEWAY® FLANGED RECEPTACLES



SAFEWAY® FLANGED RECEPTACLES



SAFEWAY® FLANGED RECEPTACLES

### Safeway® Receptacles and Inlets

| CONFIGURATION | VOLTAGE        | LOCKING BLADE (L) | FLANGED INLET | FLANGED RECEPTACLES | SINGLE RECEPTACLE <sup>1</sup> |
|---------------|----------------|-------------------|---------------|---------------------|--------------------------------|
| NEMA L14-30   | 125V/250V      | ●                 | 2874MB        | 2974MB              | 4974                           |
| NEMA L15-30   | 250V, 3 $\phi$ | ●                 | 2875MB        | 2975MB              | 4975                           |
| NEMA L16-30   | 480V, 3 $\phi$ | ●                 | 2876MB        | 2976MB              | 4976                           |
| NEMA L17-30   | 600V, 3 $\phi$ | ●                 | 2877MB        | 2977MB              | —                              |

<sup>1</sup> FOR CORROSION-RESISTANT RECEPTACLE, ADD "CR" SUFFIX TO PART NUMBER.



MOST WOODHEAD PRODUCTS HAVE U.L. AND/OR CSA APPROVALS.  
FOR A LISTING OF APPROVALS BY PART NUMBER, SEE PAGES 262-269.

WATERTITE® PLUGS &  
CONNECTORS AVAILABLE  
(SEE PAGE 104)

**30 AMP CORDSETS**

- 125V/250V – 3-Pole, 4-Wire – NEMA L14-30
  - 250V – 3-Pole, 4-Wire, 3Ø – NEMA L15-30
  - 480V – 3-Pole, 4-Wire, 3Ø – NEMA L16-30
  - 600V – 3-Pole, 4-Wire, 3Ø – NEMA L17-30

Factory pre-made Watertite® or Super-Safeway® cordsets are made from heavy-duty SOW cord and the appropriate connector bodies that fit your environment. Product photos are intended to show style only and are not intended to reflect indicated configurations.



WATERTITE® CORDSET

**Watertite® Cordsets**

| CONFIGURATION |       | VOLTAGE   | 12-GAUGE SOW CORDSETS | 10-GAUGE SOW CORDSETS |
|---------------|-------|-----------|-----------------------|-----------------------|
| NEMA L14-30   | ☉☉    | 125V/250V | 28W74_124             | 28W74_104             |
| NEMA L15-30   | ☉☉☉   | 250V, 3Ø  | 28W75_124             | 28W75_104             |
| NEMA L16-30   | ☉☉☉☉  | 480V, 3Ø  | 28W76_124             | 28W76_104             |
| NEMA L17-30   | ☉☉☉☉☉ | 600V, 3Ø  | 28W77_124             | 28W77_104             |

**Super-Safeway® Cordsets**

| CONFIGURATION |       | VOLTAGE   | 12-GAUGE SOW CORDSETS | 10-GAUGE SOW CORDSETS |
|---------------|-------|-----------|-----------------------|-----------------------|
| NEMA L14-30   | ☉☉    | 125V/250V | 2874_124              | 2874_104              |
| NEMA L15-30   | ☉☉☉   | 250V, 3Ø  | 2875_124              | 2875_104              |
| NEMA L16-30   | ☉☉☉☉  | 480V, 3Ø  | 2876_124              | 2876_104              |
| NEMA L17-30   | ☉☉☉☉☉ | 600V, 3Ø  | 2877_124              | 2877_104              |



SUPER-SAFEWAY® CORDSET

**Cordset Options:** Use the following chart to modify your part's specifications.

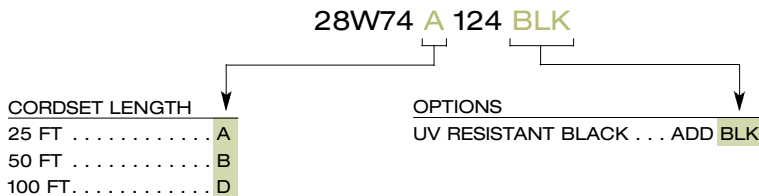

UL SP MOST WOODHEAD PRODUCTS HAVE U.L. AND/OR CSA APPROVALS. FOR A LISTING OF APPROVALS BY PART NUMBER, SEE PAGES 262-269.

## • WIRING DEVICES

### • 30 AMP/3 PHASE Y PLUGS AND CONNECTORS

- 120V/208V – 4-Pole, 5-Wire, 3ø – NEMA L21-30
- 277V/480V – 4-Pole, 5-Wire, 3ø – NEMA L22-30
- 347V/600V – 4-Pole, 5-Wire, 3ø – NEMA L23-30

Watertite® devices set the standard for the roughest, wettest and most abrasive of environments. When properly mated with corresponding connectors, Watertite® devices form an enclosure that meets the requirements of NEMA Type 4, 4X, 6 and 6P, IP65, 66 and 67, and can resist high-pressure hose-down up to 1,000 psi. Additional features include: unique multiple ring seal that locks snugly, protecting against moisture and contaminants, sturdy compression-type cord grip that provides 205 lbs. of pull-out strength, and a protective closure cap that seals the connector when it is not in use. Product photos are intended to show device style only and are not intended to reflect indicated configurations.

#### Configurations

NEMA L21-30



NEMA L22-30



NEMA L23-30

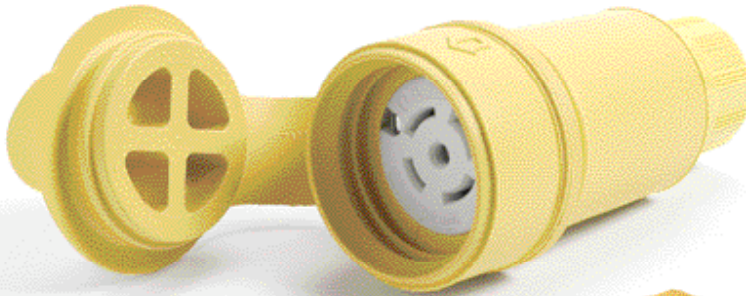

WATERTITE® CONNECTOR

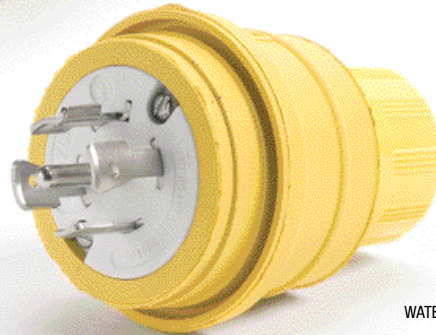

WATERTITE® PLUG

### • Watertite® Plugs and Connectors

| CONFIGURATION | VOLTAGE      | LOCKING BLADE (L) | PLUG PART NO. <sup>1,2</sup> | CONNECTOR PART NO. <sup>1,2</sup> | CORD GRIP BODY SIZE |
|---------------|--------------|-------------------|------------------------------|-----------------------------------|---------------------|
| NEMA L21-30   | 120/208V, 3ø | ●                 | 28W81                        | 29W81                             | F4 1"               |
| NEMA L22-30   | 277/480V, 3ø | ●                 | 28W82                        | 29W82                             | F4 1"               |
| NEMA L23-30   | 347/600V, 3ø | ●                 | 28W83                        | 29W83                             | F4 1"               |

<sup>1</sup> FOR CORD RANGES AND CORD SPECIFICATIONS, SEE PAGE 126.

<sup>2</sup> FOR EXTRA-HARD OUTDOOR USE, ORDER WATERTITE® DEVICES IN UV RESISTANT BLACK. ADD "BLK" TO THE END OF THE PART NUMBER.

WATERTITE® RECEPTACLES  
AVAILABLE (SEE PAGE 110)

PREMADE CORDSETS  
AVAILABLE (SEE PAGE 111)



MOST WOODHEAD PRODUCTS HAVE U.L. AND/OR CSA APPROVALS.  
FOR A LISTING OF APPROVALS BY PART NUMBER, SEE PAGES 262-269.



### 30 AMP/3 PHASE Y PLUGS AND CONNECTORS

- 120V/208V – 4-Pole, 5-Wire, 3ø – NEMA L21-30
- 277V/480V – 4-Pole, 5-Wire, 3ø – NEMA L22-30
- 347V/600V – 4-Pole, 5-Wire, 3ø – NEMA L23-30

Designed for rugged industrial and commercial use, Super-Safeway® devices share some of the advanced design features of their Watertite® counterparts. Their durable rubber housing resists heat, oil, impact, and chemicals. A patented self-centering cord clamp provides superior strain-relief for a range of cable sizes while speed screws aid in quick assembly of these dead-front back-wired devices pioneered by Woodhead. Safeway® nylon plugs and connectors are Woodhead's economical solution for industrial and commercial applications. Product photos are intended to show device style only and are not intended to reflect indicated configurations.

SUPER-SAFEWAY® PLUG



SUPER-SAFEWAY® CONNECTOR

### Super-Safeway® Plugs and Connectors

| CONFIGURATION | VOLTAGE      | LOCKING BLADE (L) | PLUG PART NO. <sup>1,2</sup> | CONNECTOR PART NO. <sup>1,2</sup> |
|---------------|--------------|-------------------|------------------------------|-----------------------------------|
| NEMA L21-30   | 120/208V, 3ø | ●                 | 2881                         | 2981                              |
| NEMA L22-30   | 277/480V, 3ø | ●                 | 2882                         | 2982                              |
| NEMA L23-30   | 347/600V, 3ø | ●                 | 2883                         | 2983                              |

SAFEWAY® PLUG

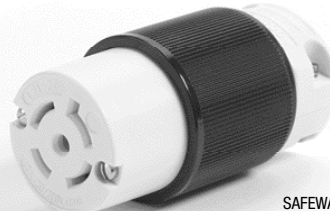

SAFEWAY® CONNECTOR

### Safeway® Plugs and Connectors<sup>3</sup>

| CONFIGURATION | VOLTAGE      | LOCKING BLADE (L) | PLUG PART NO. <sup>1</sup> | CONNECTOR PART NO. <sup>1</sup> |
|---------------|--------------|-------------------|----------------------------|---------------------------------|
| NEMA L21-30   | 120/208V, 3ø | ●                 | 28T81                      | 29T81                           |
| NEMA L22-30   | 277/480V, 3ø | ●                 | 28T82                      | 29T82                           |
| NEMA L23-30   | 347/600V, 3ø | ●                 | 28T83                      | 29T83                           |

<sup>1</sup> FOR CORD RANGES AND CORD SPECIFICATIONS, SEE PAGE 126.

<sup>2</sup> FOR EXTRA-HARD OUTDOOR USE, ORDER SUPER-SAFEWAY® DEVICES IN UV RESISTANT BLACK. ADD "BLK" TO THE END OF THE PART NO.

<sup>3</sup> TO ORDER SAFEWAY® DEVICE IN YELLOW ADD A "YL" SUFFIX TO THE WOODHEAD PART NO.



## WIRING DEVICES

### 30 AMP/3 PHASE Y RECEPTACLES

- 120V/208V – 4-Pole, 5-Wire, 3 $\phi$  – NEMA L21-30
- 277V/480V – 4-Pole, 5-Wire, 3 $\phi$  – NEMA L22-30
- 347V/600V – 4-Pole, 5-Wire, 3 $\phi$  – NEMA L23-30

Woodhead meets your receptacle needs head-on. Single, duplex or motor-base receptacles for wet abusive environments are covered by Watertite® product solutions while general industrial applications are well served by nylon Safeway® receptacles. Watertite® receptacles feature spring-loaded flip lid covers with built-in lock-out/tag-out capabilities and the patented triple seal for the best in wet-location protection. Product photos are intended to show device style only and are not intended to reflect indicated configurations.

#### Configurations



WATERTITE® SINGLE FLIP LID



WATERTITE® FLIP LID  
W/ MALE RECEPTACLE



WATERTITE® CONNECTOR FOR  
FLIP LID W/ MALE RECEPTACLE

### Watertite® Receptacles with Flip Coverplates

| CONFIGURATION | VOLTAGE            | LOCKING BLADE (L) | SINGLE FLIP LID | FLIP LID WITH MALE RECEPTACLE | CONNECTOR FOR FLIP LID WITH MALE RECEPTACLE |
|---------------|--------------------|-------------------|-----------------|-------------------------------|---|
| NEMA L21-30   | 120/208V, 3 $\phi$ | ●                 | 69W81           | 68W81                         | 29W81MB                                     |
| NEMA L22-30   | 277/480V, 3 $\phi$ | ●                 | 69W82           | 68W82                         | 29W82MB                                     |
| NEMA L23-30   | 347/600V, 3 $\phi$ | ●                 | 69W83           | 68W83                         | 29W83MB                                     |



SAFEWAY® FLANGED RECEPTACLES



SAFEWAY® FLANGED INLET

### Safeway® Receptacles and Inlets

| CONFIGURATION | VOLTAGE            | LOCKING BLADE (L) | FLANGED INLET | FLANGED RECEPTACLES |
|---------------|--------------------|-------------------|---------------|---------------------|
| NEMA L21-30   | 120/208V, 3 $\phi$ | ●                 | 2881MB        | 2981MB              |
| NEMA L22-30   | 277/480V, 3 $\phi$ | ●                 | 2882MB        | 2982MB              |
| NEMA L23-30   | 347/600V, 3 $\phi$ | ●                 | 2883MB        | 2983MB              |



MOST WOODHEAD PRODUCTS HAVE U.L. AND/OR CSA APPROVALS.  
FOR A LISTING OF APPROVALS BY PART NUMBER, SEE PAGES 262-269.

WATERTITE® PLUGS &  
CONNECTORS AVAILABLE  
(SEE PAGE 108)

**30 AMP/3 PHASE Y WIRE CORDSETS**

- 120V/208V – 4-Pole, 5-Wire, 3ø – NEMA L21-30
- 277V/480V – 4-Pole, 5-Wire, 3ø – NEMA L22-30
- 347V/600V – 4-Pole, 5-Wire, 3ø – NEMA L23-30

Factory pre-made Watertite® or Super-Safeway® cordsets are made from heavy-duty SOW cord and the appropriate connector bodies that fit your environment. Product photos are intended to show style only and are not intended to reflect indicated configurations.



WATERTITE® CORDSET

**Watertite® Cordsets**

| CONFIGURATION |     | VOLTAGE      | 12-GAUGE SOW CORDSETS | 10-GAUGE SOW CORDSETS |
|---------------|-----|--------------|-----------------------|-----------------------|
| NEMA L21-30   | ⊕⊕  | 120/208V, 3ø | 28W81_125             | 28W81_105             |
| NEMA L22-30   | ⊕⊕⊕ | 277/480V, 3ø | 28W82_125             | 28W82_105             |
| NEMA L23-30   | ⊕⊕⊕ | 347/600V, 3ø | 28W83_125             | 28W83_105             |



SUPER-SAFEWAY® CORDSET

**Super-Safeway® Cordsets**

| CONFIGURATION |     | VOLTAGE      | 12-GAUGE SOW CORDSETS | 10-GAUGE SOW CORDSETS |
|---------------|-----|--------------|-----------------------|-----------------------|
| NEMA L21-30   | ⊕⊕  | 120/208V, 3ø | 2881_125              | 2881_105              |
| NEMA L22-30   | ⊕⊕⊕ | 277/480V, 3ø | 2882_125              | 2882_105              |
| NEMA L23-30   | ⊕⊕⊕ | 347/600V, 3ø | 2883_125              | 2883_105              |

**Cordset Options:** Use the following chart to modify your part's specifications.

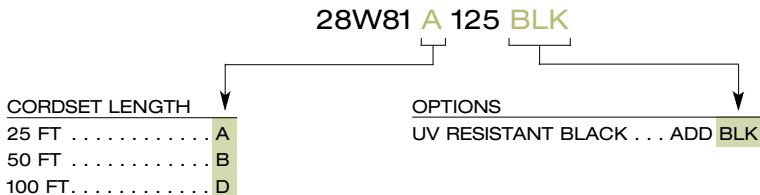

MOST WOODHEAD PRODUCTS HAVE U.L. AND/OR CSA APPROVALS. FOR A LISTING OF APPROVALS BY PART NUMBER, SEE PAGES 262-269.

## WIRING DEVICES

### 50 AMP PLUGS AND CONNECTORS

- 125V – 2-Pole, 3-Wire – Non-NEMA Locking / Non-NEMA Locking California Style
- 250V – 2-Pole, 3-Wire – Non-NEMA Locking / Non-NEMA Locking California Style / NEMA 6-50
- 480V – 2-Pole, 3-Wire – Non-NEMA Locking California Style

WATERTITE® PLUG



WATERTITE® CONNECTOR

#### Configurations

|                     |  |
|---------------------|--|
| Non-NEMA Locking CA |  |
| Non-NEMA Locking    |  |
| Non-NEMA Locking CA |  |
| Non-NEMA Locking    |  |
| Non-NEMA Locking CA |  |
| NEMA 6-50           |  |

### Watertite® Plugs and Connectors

| CONFIGURATION                    | VOLTAGE         | LOCKING BLADE (L) | PLUG PART NO. <sup>1,2</sup> | CONNECTOR PART NO. <sup>1,2</sup> | CORD GRIP BODY SIZE |
|----------------------------------|-----------------|-------------------|------------------------------|-----------------------------------|---------------------|
| NON-NEMA LOCKING CA <sup>3</sup> | 125V            | ●                 | CS63W61                      | CS63W60                           | F5 1¼"              |
| NON-NEMA LOCKING                 | 125V            | ●                 | 63W61                        | 63W60                             | F5 1¼"              |
| NON-NEMA LOCKING CA <sup>3</sup> | 250V            | ●                 | CS82W65                      | CS82W64                           | F5 1¼"              |
| NON-NEMA LOCKING                 | 600V AC/250V DC | ●                 | 37W63                        | 37W62                             | F5 1¼"              |
| NON-NEMA LOCKING CA <sup>3</sup> | 480V            | ●                 | CS84W65                      | CS84W64                           | F5 1¼"              |

SUPER-SAFEWAY® PLUG



SUPER-SAFEWAY® CONNECTOR

### Super-Safeway® Plugs and Connectors

| CONFIGURATION | VOLTAGE | LOCKING BLADE (L) | PLUG PART NO. <sup>1,2</sup> | CONNECTOR PART NO. <sup>1,2</sup> |
|---------------|---------|-------------------|------------------------------|-----------------------------------|
| NEMA 6-50     | 250V    |                   | 8664                         | 8665                              |

SAFEWAY® PLUG



SAFEWAY® CONNECTOR

### Safeway® Plugs and Connectors<sup>4</sup>

| CONFIGURATION                    | VOLTAGE         | LOCKING BLADE (L) | PLUG PART NO. <sup>1</sup> | CONNECTOR PART NO. <sup>1</sup> |
|----------------------------------|-----------------|-------------------|----------------------------|---------------------------------|
| NON-NEMA LOCKING CA <sup>3</sup> | 125V            | ●                 | CS6361N                    | CS6360N                         |
| NON-NEMA LOCKING                 | 125V            | ●                 | 6361CRN                    | 6360CRN                         |
| NON-NEMA LOCKING CA <sup>3</sup> | 250V            | ●                 | CS8265N                    | CS8264N                         |
| NON-NEMA LOCKING                 | 600V AC/250V DC | ●                 | 3763N                      | 3762N                           |
| NON-NEMA LOCKING CA <sup>3</sup> | 480V            | ●                 | CS8465N                    | CS8464N                         |

<sup>1</sup> FOR CORD RANGES AND CORD SPECIFICATIONS, SEE PAGE 126.

<sup>2</sup> FOR EXTRA-HARD OUTDOOR USE, ORDER WATERTITE® OR SUPER-SAFEWAY® DEVICES IN UV RESISTANT BLACK. ADD "BLK" TO THE END OF THE PART NO.

<sup>3</sup> CALIFORNIA STYLE

<sup>4</sup> TO ORDER SAFEWAY® DEVICE IN YELLOW ADD A "YL" SUFFIX TO THE WOODHEAD PART NO.

MOST WOODHEAD PRODUCTS HAVE U.L. AND/OR CSA APPROVALS. FOR A LISTING OF APPROVALS BY PART NUMBER, SEE PAGES 262-269.

**50 AMP RECEPTACLES**

- 125V – 2-Pole, 3-Wire – Non-NEMA Locking / Non-NEMA Locking California Style
- 250V – 2-Pole, 3-Wire – Non-NEMA Locking / Non-NEMA Locking California Style
- 480V – 2-Pole, 3-Wire – Non-NEMA Locking California Style

Woodhead meets your receptacle needs head-on. Single, duplex or motor-base receptacles for wet abusive environments are covered by Watertite® product solutions while general industrial applications are well served by nylon Safeway® receptacles. Watertite® receptacles feature spring-loaded flip lid covers with built-in lock-out/tag-out capabilities and the patented triple seal for the best in wet-location protection. Product photos are intended to show device style only and are not intended to reflect indicated configurations.

SINGLE FLIP LID

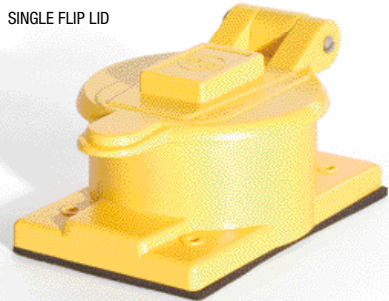

**Receptacles with Flip Coverplates**

| CONFIGURATION                    | VOLTAGE         | LOCKING BLADE (L) | SINGLE FLIP LID <sup>1</sup> |
|----------------------------------|-----------------|-------------------|------------------------------|
| NON-NEMA LOCKING CA <sup>2</sup> | 125V            | ●                 | CS69W60                      |
| NON-NEMA LOCKING                 | 125V            | ●                 | 69W60                        |
| NON-NEMA LOCKING CA <sup>2</sup> | 250V            | ●                 | 69W64                        |
| NON-NEMA LOCKING                 | 250V            | ●                 | 69W62                        |
| NON-NEMA LOCKING CA <sup>2</sup> | 600V AC/250V DC | ●                 | 69W62                        |
| NON-NEMA LOCKING CA <sup>2</sup> | 480V            | ●                 | 67W64                        |



SAFEWAY® SINGLE RECEPTACLE



SAFEWAY® FLANGED INLET

**Safeway® Receptacles and Inlets**

| CONFIGURATION                    | VOLTAGE       | LOCKING BLADE (L) | SINGLE RECEPTACLE <sup>3, 4</sup> | FLANGED INLET |
|----------------------------------|---------------|-------------------|-----------------------------------|---------------|
| NON-NEMA LOCKING CA <sup>2</sup> | 125V          | ●                 | CS6370                            | CS6377        |
| NON-NEMA LOCKING                 | 125V          | ●                 | 6370CR                            | 6377CR        |
| NON-NEMA LOCKING CA <sup>2</sup> | 250V          | ●                 | CS8269                            | CS8275        |
| NON-NEMA LOCKING                 | 250V          | ●                 | 3771                              | 3777          |
| NON-NEMA LOCKING CA <sup>2</sup> | 600VAC/250VDC | ●                 | 3771                              | 3777          |
| NON-NEMA LOCKING CA <sup>2</sup> | 480V          | ●                 | CS8469                            | CS8475        |

<sup>1</sup> FOR EXTRA-HARD OUTDOOR USE, ORDER WATERTITE® DEVICES IN UV RESISTANT BLACK. ADD "BLK" TO THE END OF THE PART NO.

<sup>2</sup> CALIFORNIA STYLE

<sup>3</sup> STANDARD COLOR IS BLACK

<sup>4</sup> FOR CORROSION-RESISTANT RECEPTACLE, ADD "CR" SUFFIX TO PART NO.

## WIRING DEVICES

### 50 AMP PLUGS AND CONNECTORS

- 125V – 3-Pole, 4-Wire – Non-NEMA Locking / Non-NEMA Locking California Style
- 250V – 3-Pole, 4-Wire – Non-NEMA Locking / Non-NEMA Locking California Style
- 480V – 3-Pole, 4-Wire – Non-NEMA Locking California Style

WATERTITE® PLUG

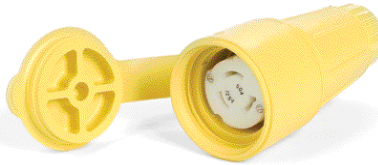

WATERTITE® CONNECTOR

#### Configurations

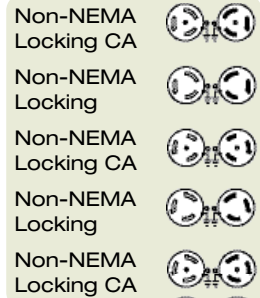

### Watertite® Plugs and Connectors

| CONFIGURATION                    | VOLTAGE         | LOCKING BLADE (L) | PLUG PART NO. <sup>1,2</sup> | CONNECTOR PART NO. <sup>1,2</sup> | CORD GRIP BODY SIZE |
|----------------------------------|-----------------|-------------------|------------------------------|-----------------------------------|---------------------|
| NON-NEMA LOCKING CA <sup>3</sup> | 125/250V        | ●                 | CS63W65                      | CS63W64                           | F5 1¼"              |
| NON-NEMA LOCKING                 | 125/250V        | ●                 | 63W65                        | 63W64                             | F5 1¼"              |
| NON-NEMA LOCKING CA <sup>3</sup> | 250V/3PH        | ●                 | CS83W65                      | CS83W64                           | F5 1¼"              |
| NON-NEMA LOCKING                 | 600V AC/250V DC | ●                 | 37W65                        | 37W64                             | F5 1¼"              |
| NON-NEMA LOCKING CA <sup>3</sup> | 480V/3PH        | ●                 | CS81W65                      | CS81W64                           | F5 1¼"              |

SAFEWAY® PLUG



SAFEWAY® CONNECTOR

### Safeway® Plugs and Connectors<sup>4</sup>

| CONFIGURATION                    | VOLTAGE         | LOCKING BLADE (L) | PLUG PART NO. <sup>1</sup> | CONNECTOR PART NO. <sup>1</sup> |
|----------------------------------|-----------------|-------------------|----------------------------|---------------------------------|
| NON-NEMA LOCKING CA <sup>3</sup> | 125/250V        | ●                 | CS6365N                    | CS6364N                         |
| NON-NEMA LOCKING                 | 125/250V        | ●                 | 6365CRN                    | 6364CRN                         |
| NON-NEMA LOCKING CA <sup>3</sup> | 250V/3PH        | ●                 | CS8365N                    | CS8364N                         |
| NON-NEMA LOCKING                 | 600V AC/250V DC | ●                 | 3765N                      | 3764N                           |
| NON-NEMA LOCKING CA <sup>3</sup> | 480V/3PH        | ●                 | CS8165N                    | CS8164N                         |

<sup>1</sup> FOR CORD RANGES AND CORD SPECIFICATIONS, SEE PAGE 126.

<sup>2</sup> FOR EXTRA-HARD OUTDOOR USE, ORDER WATERTITE® DEVICES IN UV RESISTANT BLACK. ADD "BLK" TO THE END OF THE PART NO.

<sup>3</sup> CALIFORNIA STYLE.

<sup>4</sup> TO ORDER SAFEWAY® DEVICE IN YELLOW ADD A "YL" SUFFIX TO THE WOODHEAD PART NO.



MOST WOODHEAD PRODUCTS HAVE U.L. AND/OR CSA APPROVALS.  
FOR A LISTING OF APPROVALS BY PART NUMBER, SEE PAGES 262-269.

**50 AMP RECEPTACLES**

- 125V – 3-Pole, 4-Wire – Non-NEMA Locking / Non-NEMA Locking California Style
- 250V – 3-Pole, 4-Wire – Non-NEMA Locking / Non-NEMA Locking California Style
- 480V – 3-Pole, 4-Wire – Non-NEMA Locking California Style

Woodhead meets your receptacle needs head-on. Single, duplex or motor-base receptacles for wet abusive environments are covered by Watertite® product solutions while general industrial applications are well served by nylon Safeway® receptacles. Watertite® receptacles feature spring-loaded flip lid covers with built-in lock-out/tag-out capabilities and the patented triple seal for the best in wet-location protection. Product photos are intended to show device style only and are not intended to reflect indicated configurations.

SINGLE FLIP LID

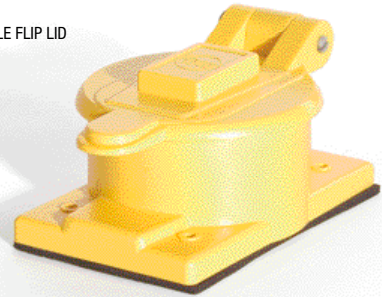

**Receptacles with Flip Coverplates**

| CONFIGURATION                    | VOLTAGE         | LOCKING BLADE (L) | SINGLE FLIP LID |
|----------------------------------|-----------------|-------------------|-----------------|
| NON-NEMA LOCKING CA <sup>1</sup> | 125/250V        | ●                 | CS60W64         |
| NON-NEMA LOCKING                 | 125/250V        | ●                 | 60W64           |
| NON-NEMA LOCKING CA <sup>1</sup> | 250V/3PH        | ●                 | 65W64           |
| NON-NEMA LOCKING                 | 600V AC/250V DC | ●                 | 66W64           |
| NON-NEMA LOCKING CA <sup>1</sup> | 480V/3PH        | ●                 | 64W64           |



SAFEWAY® SINGLE RECEPTACLE



SAFEWAY® FLANGED INLET

**Safeway® Receptacles and Inlets**

| CONFIGURATION                    | VOLTAGE         | LOCKING BLADE (L) | SINGLE RECEPTACLE <sup>2,3</sup> | FLANGED INLET |
|----------------------------------|-----------------|-------------------|----------------------------------|---------------|
| NON-NEMA LOCKING CA <sup>1</sup> | 125/250V        | ●                 | CS6369                           | CS6375        |
| NON-NEMA LOCKING                 | 125/250V        | ●                 | 6369CR                           | 6375CR        |
| NON-NEMA LOCKING CA <sup>1</sup> | 250V/3PH        | ●                 | CS8369                           | CS8375        |
| NON-NEMA LOCKING                 | 600V AC/250V DC | ●                 | 3769                             | 3775          |
| NON-NEMA LOCKING CA <sup>1</sup> | 480V/3PH        | ●                 | CS8169                           | CS8175        |

<sup>1</sup> CALIFORNIA STYLE

<sup>2</sup> STANDARD COLOR IS BLACK

<sup>3</sup> FOR CORROSION-RESISTANT RECEPTACLE, ADD "CR" SUFFIX TO PART NO.

MOST WOODHEAD PRODUCTS HAVE U.L. AND/OR CSA APPROVALS. FOR A LISTING OF APPROVALS BY PART NUMBER, SEE PAGES 262-269.



## WIRING DEVICES

### WATERTITE® (IP67) Pin-&-Sleeve Devices: Plugs, Connectors, Receptacles, Angled Inlets and Mechanical Interlocks

Woodhead pin and sleeve wiring devices conform to IEC 309-1 and 309-2 standards which are a worldwide pin and sleeve standard established by the International Electrotechnical Commission. They also meet the requirements of Section 410-56(g) of the National Electrical Code (NEC). Watertite® pin and sleeve products are rated at IP67 while Safeway® pin and sleeve products are rated IP44. Both styles feature impact and chemical-resistant type G nylon housings and dead front construction. A latching mechanism prevents accidental disengagement while internal and external strain relief provides pull-out protection and cable bend relief.



MECHANICAL INTERLOCK



ANGLED INLET



CONNECTOR

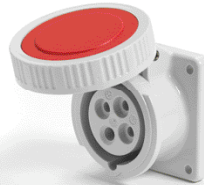

RECEPTACLE



PLUG

### 20 Amp Watertite® Devices

| POLE/WIRE       | COLOR  | VOLTAGE     | FACE VIEW | RECEPTACLE PART NO. | PLUG PART NO. | CONNECTOR PART NO. | ANGLED INLET | MECHANICAL INTERLOCK PART NO. |
|-----------------|--------|-------------|-----------|---------------------|---------------|--------------------|--------------|-------------------------------|
| 2-POLE / 3-WIRE | YELLOW | 125         | ⊕         | 320R4W              | 320P4W        | 320C4W             | 320BA4W      | 320MI4W                       |
|                 | BLUE   | 250         | ⊕         | 320R6W              | 320P6W        | 320C6W             | 320BA5W      | 320MI6W                       |
|                 | GRAY   | 277         | ⊕         | 320R5W              | 320P5W        | 320C5W             | 320BA6W      | —                             |
|                 | RED    | 480         | ⊕         | 320R7W              | 320P7W        | 320C7W             | 320BA7W      | 320MI7W                       |
| 3-POLE / 4-WIRE | ORANGE | 125/250     | ⊕         | 420R12W             | 420P12W       | 420C12W            | 420BA12W     | 420MI12W                      |
|                 | BLUE   | 3ø250       | ⊕         | 420R9W              | 420P9W        | 420C9W             | 420BA9W      | 420MI9W                       |
|                 | RED    | 3ø480       | ⊕         | 420R7W              | 420P7W        | 420C7W             | 420BA7W      | 420MI7W                       |
|                 | BLACK  | 3ø600       | ⊕         | 420R5W              | 420P5W        | 420C5W             | 420BA5W      | 420MI5W                       |
| 4-POLE / 5-WIRE | BLUE   | 3øY 120/208 | ⊕         | 520R9W              | 520P9W        | 520C9W             | 520BA9W      | 520MI9W                       |
|                 | RED    | 3øY 277/480 | ⊕         | 520R7W              | 520P7W        | 520C7W             | 520BA7W      | 520MI7W                       |
|                 | BLACK  | 3øY 347/600 | ⊕         | 520R5W              | 520P5W        | 520C5W             | 520BA5W      | 520MI5W                       |

NOTE: FOR TECHNICAL AND DIMENSIONAL INFORMATION SEE PAGE 127.



MOST WOODHEAD PRODUCTS HAVE U.L. AND/OR CSA APPROVALS.  
FOR A LISTING OF APPROVALS BY PART NUMBER, SEE PAGES 262-269.

**WATERTITE® (IP67) Pin-&-Sleeve Devices: Plugs, Connectors, Receptacles, Angled Inlets and Mechanical Interlocks (continued)**

**30 Amp Watertite® Devices**

| POLE/WIRE       | COLOR  | VOLTAGE     | FACE VIEW | RECEPTACLE PART NO. | PLUG PART NO. | CONNECTOR PART NO. | ANGLED INLET | MECHANICAL INTERLOCK PART NO. |
|-----------------|--------|-------------|-----------|---------------------|---------------|--------------------|--------------|-------------------------------|
| 2-POLE / 3-WIRE | YELLOW | 125         | ⊕         | 330R4W              | 330P4W        | 330C4W             | 330BA4W      | 330MI4W                       |
|                 | BLUE   | 250         | ⊕         | 330R6W              | 330P6W        | 330C6W             | 330BA5W      | 330MI6W                       |
|                 | GRAY   | 277         | ⊕         | 330R5W              | 330P5W        | 330C5W             | 330BA6W      | —                             |
|                 | RED    | 480         | ⊕         | 330R7W              | 330P7W        | 330C7W             | 330BA7W      | 330MI7W                       |
| 3-POLE / 4-WIRE | ORANGE | 125/250     | ⊕         | 430R12W             | 430P12W       | 430C12W            | 330BA12W     | 430MI12W                      |
|                 | BLUE   | 3ø250       | ⊕         | 430R9W              | 430P9W        | 430C9W             | 430BA9W      | 430MI9W                       |
|                 | RED    | 3ø480       | ⊕         | 430R7W              | 430P7W        | 430C7W             | 430BA7W      | 430MI7W                       |
|                 | BLACK  | 3ø600       | ⊕         | 430R5W              | 430P5W        | 430C5W             | 430BA5W      | 430MI5W                       |
| 4-POLE / 5-WIRE | BLUE   | 3øY 120/208 | ⊕         | 530R9W              | 530P9W        | 530C9W             | 530BA9W      | 530MI9W                       |
|                 | RED    | 3øY 277/480 | ⊕         | 530R7W              | 530P7W        | 530C7W             | 530BA7W      | 530MI7W                       |
|                 | BLACK  | 3øY 347/600 | ⊕         | 530R5W              | 530P5W        | 530C5W             | 530BA5W      | 530MI5W                       |

**60 Amp Watertite® Devices**

| POLE/WIRE       | COLOR  | VOLTAGE     | FACE VIEW | RECEPTACLE PART NO. | PLUG PART NO. | CONNECTOR PART NO. | ANGLED INLET | MECHANICAL INTERLOCK PART NO. |
|-----------------|--------|-------------|-----------|---------------------|---------------|--------------------|--------------|-------------------------------|
| 2-POLE / 3-WIRE | YELLOW | 125         | ⊕         | 360R4W              | 360P4W        | 360C4W             | 360BA4W      | 360MI4W                       |
|                 | BLUE   | 250         | ⊕         | 360R6W              | 360P6W        | 360C6W             | 360BA5W      | 360MI6W                       |
|                 | GRAY   | 277         | ⊕         | 360R5W              | 360P5W        | 360C5W             | 360BA6W      | —                             |
|                 | RED    | 480         | ⊕         | 360R7W              | 360P7W        | 360C7W             | 360BA7W      | 360MI7W                       |
| 3-POLE / 4-WIRE | ORANGE | 125/250     | ⊕         | 460R12W             | 460P12W       | 460C12W            | 460BA12W     | 460MI12W                      |
|                 | BLUE   | 3ø250       | ⊕         | 460R9W              | 460P9W        | 460C9W             | 460BA9W      | 460MI9W                       |
|                 | RED    | 3ø480       | ⊕         | 460R7W              | 460P7W        | 460C7W             | 460BA7W      | 460MI7W                       |
|                 | BLACK  | 3ø600       | ⊕         | 460R5W              | 460P5W        | 460C5W             | 460BA5W      | 460MI5W                       |
| 4-POLE / 5-WIRE | BLUE   | 3øY 120/208 | ⊕         | 560R9W              | 560P9W        | 560C9W             | 560BA9W      | 560MI9W                       |
|                 | RED    | 3øY 277/480 | ⊕         | 560R7W              | 560P7W        | 560C7W             | 560BA7W      | 560MI7W                       |
|                 | BLACK  | 3øY 347/600 | ⊕         | 560R5W              | 560P5W        | 560C5W             | 560BA5W      | 560MI5W                       |

**100 Amp Watertite® Devices**

| POLE/WIRE       | COLOR  | VOLTAGE     | FACE VIEW | RECEPTACLE PART NO. | PLUG PART NO. | CONNECTOR PART NO. | ANGLED INLET | MECHANICAL INTERLOCK PART NO. |
|-----------------|--------|-------------|-----------|---------------------|---------------|--------------------|--------------|-------------------------------|
| 2-POLE / 3-WIRE | YELLOW | 125         | ⊕         | 3100R4W             | 3100P4W       | 3100C4W            | 3100B4W      | 3100MI4W                      |
|                 | BLUE   | 250         | ⊕         | 3100R6W             | 3100P6W       | 3100C6W            | 3100B5W      | 3100MI6W                      |
|                 | GRAY   | 277         | ⊕         | 3100R5W             | 3100P5W       | 3100C5W            | 3100B6W      | —                             |
|                 | RED    | 480         | ⊕         | 3100R7W             | 3100P7W       | 3100C7W            | 3100B7W      | 3100MI7W                      |
| 3-POLE / 4-WIRE | ORANGE | 125/250     | ⊕         | 4100R12W            | 4100P12W      | 4100C12W           | 4100B12W     | 4100MI12W                     |
|                 | BLUE   | 3ø250       | ⊕         | 4100R9W             | 4100P9W       | 4100C9W            | 4100B9W      | 4100MI9W                      |
|                 | RED    | 3ø480       | ⊕         | 4100R7W             | 4100P7W       | 4100C7W            | 4100B7W      | 4100MI7W                      |
|                 | BLACK  | 3ø600       | ⊕         | 4100R5W             | 4100P5W       | 4100C5W            | 4100B5W      | 4100MI5W                      |
| 4-POLE / 5-WIRE | BLUE   | 3øY 120/208 | ⊕         | 5100R9W             | 5100P9W       | 5100C9W            | 5100B9W      | 5100MI9W                      |
|                 | RED    | 3øY 277/480 | ⊕         | 5100R7W             | 5100P7W       | 5100C7W            | 5100B7W      | 5100MI7W                      |
|                 | BLACK  | 3øY 347/600 | ⊕         | 5100R5W             | 5100P5W       | 5100C5W            | 5100B5W      | 5100MI5W                      |

NOTE: FOR TECHNICAL AND DIMENSIONAL INFORMATION SEE PAGE 127.

 MOST WOODHEAD PRODUCTS HAVE U.L. AND/OR CSA APPROVALS. FOR A LISTING OF APPROVALS BY PART NUMBER, SEE PAGES 262-269.

## WIRING DEVICES

### SAFEWAY® (IP44 – Splashproof) Pin-&-Sleeve: Plugs, Connectors, Receptacles, Angled Inlets and Mechanical Interlocks

Woodhead pin and sleeve wiring devices conform to IEC 309-1 and 309-2 standards which are a worldwide pin and sleeve standard established by the International Electro technical Commission. They also meet the requirements of Section 410-56(g) of the National Electrical Code (NEC). Watertite® pin and sleeve products are rated at IP67 while Safeway® pin and sleeve products are rated IP44. Both styles feature impact and chemical-resistant type G nylon housings and dead front construction. A latching mechanism prevents accidental disengagement while internal and external strain relief provides pull-out protection and cable bend relief.

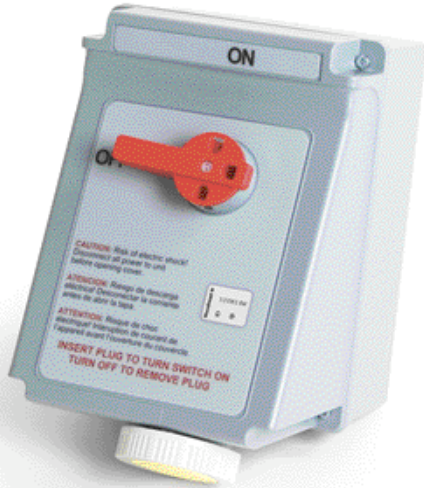

MECHANICAL INTERLOCK



ANGLED INLET



CONNECTOR



RECEPTACLE



PLUG

### 20 Amp Safeway® Devices

| POLE/WIRE       | COLOR  | VOLTAGE     | FACE VIEW | RECEPTACLE PART NO. | PLUG PART NO. | CONNECTOR PART NO. | ANGLED INLET | MECHANICAL INTERLOCK PART NO. |
|-----------------|--------|-------------|-----------|---------------------|---------------|--------------------|--------------|-------------------------------|
| 2-POLE / 3-WIRE | YELLOW | 125         | ⊗         | 320R4               | 320P4         | 320C4              | 320BA4       | 320MI4                        |
|                 | BLUE   | 250         | ⊗         | 320R6               | 320P6         | 320C6              | 320BA5       | 320MI6                        |
|                 | GRAY   | 277         | ⊗         | 320R5               | 320P5         | 320C5              | 320BA6       | 320MI5                        |
|                 | RED    | 480         | ⊗         | 320R7               | 320P7         | 320C7              | 320BA7       | 320MI7                        |
| 3-POLE / 4-WIRE | ORANGE | 125/250     | ⊗         | 420R12              | 420P12        | 420C12             | 420BA12      | 420MI12                       |
|                 | BLUE   | 3ø250       | ⊗         | 420R9               | 420P9         | 420C9              | 420BA9       | 420MI9                        |
|                 | RED    | 3ø480       | ⊗         | 420R7               | 420P7         | 420C7              | 420BA7       | 420MI7                        |
|                 | BLACK  | 3ø600       | ⊗         | 420R5               | 420P5         | 420C5              | 420BA5       | 420MI5                        |
| 4-POLE / 5-WIRE | BLUE   | 3øY 120/208 | ⊗         | 520R9               | 520P9         | 520C9              | 520BA9       | 520MI9                        |
|                 | RED    | 3øY 277/480 | ⊗         | 520R7               | 520P7         | 520C7              | 520BA7       | 520MI7                        |
|                 | BLACK  | 3øY 347/600 | ⊗         | 520R5               | 520P5         | 520C5              | 520BA5       | 520MI5                        |

NOTE: FOR TECHNICAL AND DIMENSIONAL INFORMATION SEE PAGE 127.



MOST WOODHEAD PRODUCTS HAVE U.L. AND/OR CSA APPROVALS.  
FOR A LISTING OF APPROVALS BY PART NUMBER, SEE PAGES 262-269.

**SAFEWAY®** (IP44 – Splashproof) Pin-&-Sleeve: Plugs, Connectors, Receptacles, Angled Inlets and Mechanical Interlocks (continued)

**30 Amp Safeway® Devices**

| POLE/WIRE       | COLOR  | VOLTAGE     | FACE VIEW | RECEPTACLE PART NO. | PLUG PART NO. | CONNECTOR PART NO. | ANGLED INLET | MECHANICAL INTERLOCK PART NO. |
|-----------------|--------|-------------|-----------|---------------------|---------------|--------------------|--------------|-------------------------------|
| 2-POLE / 3-WIRE | YELLOW | 125         | ⊕         | 330R4               | 330P4         | 330C4              | 330BA4       | 330MI4                        |
|                 | BLUE   | 250         | ⊕         | 330R6               | 330P6         | 330C6              | 330BA5       | 330MI6                        |
|                 | GRAY   | 277         | ⊕         | 330R5               | 330P5         | 330C5              | 330BA6       | 330MI5                        |
|                 | RED    | 480         | ⊕         | 330R7               | 330P7         | 330C7              | 330BA7       | 330MI7                        |
| 3-POLE / 4-WIRE | ORANGE | 125/250     | ⊕         | 430R12              | 430P12        | 430C12             | 430BA12      | 430MI12                       |
|                 | BLUE   | 3ø250       | ⊕         | 430R9               | 430P9         | 430C9              | 430BA9       | 430MI9                        |
|                 | RED    | 3ø480       | ⊕         | 430R7               | 430P7         | 430C7              | 430BA7       | 430MI7                        |
|                 | BLACK  | 3ø600       | ⊕         | 430R5               | 430P5         | 430C5              | 430BA5       | 430MI5                        |
| 4-POLE / 5-WIRE | BLUE   | 3øY 120/208 | ⊕         | 530R9               | 530P9         | 530C9              | 530BA9       | 530MI9                        |
|                 | RED    | 3øY 277/480 | ⊕         | 530R7               | 530P7         | 530C7              | 530BA7       | 530MI7                        |
|                 | BLACK  | 3øY 347/600 | ⊕         | 530R5               | 530P5         | 530C5              | 530BA5       | 530MI5                        |

**60 Amp Safeway® Devices**

| POLE/WIRE       | COLOR  | VOLTAGE     | FACE VIEW | RECEPTACLE PART NO. | PLUG PART NO. | CONNECTOR PART NO. | ANGLED INLET | MECHANICAL INTERLOCK PART NO. |
|-----------------|--------|-------------|-----------|---------------------|---------------|--------------------|--------------|-------------------------------|
| 2-POLE / 3-WIRE | YELLOW | 125         | ⊕         | 360R4               | 360P4         | 360C4              | 360BA4       | 360MI4                        |
|                 | BLUE   | 250         | ⊕         | 360R6               | 360P6         | 360C6              | 360BA5       | 360MI6                        |
|                 | GRAY   | 277         | ⊕         | 360R5               | 360P5         | 360C5              | 360BA6       | 360MI5                        |
|                 | RED    | 480         | ⊕         | 360R7               | 360P7         | 360C7              | 360BA7       | 360MI7                        |
| 3-POLE / 4-WIRE | ORANGE | 125/250     | ⊕         | 460R12              | 460P12        | 460C12             | 460BA12      | 460MI12                       |
|                 | BLUE   | 3ø250       | ⊕         | 460R9               | 460P9         | 460C9              | 460BA9       | 460MI9                        |
|                 | RED    | 3ø480       | ⊕         | 460R7               | 460P7         | 460C7              | 460BA7       | 460MI7                        |
|                 | BLACK  | 3ø600       | ⊕         | 460R5               | 460P5         | 460C5              | 460BA5       | 460MI5                        |
| 4-POLE / 5-WIRE | BLUE   | 3øY 120/208 | ⊕         | 560R9               | 560P9         | 560C9              | 560BA9       | 560MI9                        |
|                 | RED    | 3øY 277/480 | ⊕         | 560R7               | 560P7         | 560C7              | 560BA7       | 560MI7                        |
|                 | BLACK  | 3øY 347/600 | ⊕         | 560R5               | 560P5         | 560C5              | 560BA5       | 560MI5                        |

NOTE: FOR TECHNICAL AND DIMENSIONAL INFORMATION SEE PAGE 127.

 MOST WOODHEAD PRODUCTS HAVE U.L. AND/OR CSA APPROVALS. FOR A LISTING OF APPROVALS BY PART NUMBER, SEE PAGES 262-269.

## WIRING DEVICES

### SAFEGWAY® Pin-&-Sleeve Devices: 60 Amp Exposition Devices

- 277V/480V – 4-Pole, 5-Wire Grounding

Designed specifically for the Expo Center environment, Woodhead Expo Connectors provide a single device that accepts both flat and round cable, a durable light-weight construction and a non-conductive exterior. This new design provides compact versatility in 60 amp configurations. Woodhead Expo Connectors are specifically designed for power distribution from ceiling drops, wall mounts and floor boxes to portable panel-boards.

#### Configurations



part no. **Y560B**



part no. **Y560R**

 MOST WOODHEAD PRODUCTS HAVE U.L. AND/OR CSA APPROVALS.  
FOR A LISTING OF APPROVALS BY PART NUMBER, SEE PAGES 262-269.



**SAFEGWAY® Pin-&-Sleeve Devices: 60 Amp Exposition Devices**  
 • 277V/480V – 4-Pole, 5-Wire Grounding



part no. **Y561B**



part no. **Y561R**



part no. **Y560CF**



part no. **Y560PF**



part no. **50-0110**

**60 Amp Exposition Devices**

| DESCRIPTION                          | FACE VIEW | PART NO.                   |
|--------------------------------------|-----------|----------------------------|
| 60A EXPOSITION RECEPTACLE            |           | <b>Y560R</b>               |
| 60A EXPOSITION CONNECTOR             |           | <b>Y560CF<sup>1</sup></b>  |
| 60A EXPOSITION RECEPTACLE W/FLIP LID |           | <b>Y561R</b>               |
| 60A EXPOSITION PLUG                  |           | <b>Y560PF<sup>1</sup></b>  |
| 60A EXPOSITION INLET                 |           | <b>Y560B</b>               |
| 60A EXPOSITION INLET W/FLIP LID      |           | <b>Y561B</b>               |
| ADAPTER PLATE FOR STANDARD BACK BOX  |           | <b>50-0110<sup>2</sup></b> |
| REPLACEMENT CABLE CLAMP              |           | <b>40-0560</b>             |

<sup>1</sup> INCLUDES BOTH FLAT AND ROUND CLAMPS.

<sup>2</sup> REQUIRED IF MOUNTING RECEPTACLE TO A STANDARD INDUSTRY BACK BOX.



MOST WOODHEAD PRODUCTS HAVE U.L. AND/OR CSA APPROVALS.  
 FOR A LISTING OF APPROVALS BY PART NUMBER, SEE PAGES 262-269.

# WIRING DEVICES

## SAFEGWAY® Adapters

### Industrial-Duty Adapters

Read across for plug (blade) configuration, then read down for receptacle (slot) configuration. Order the Woodhead number in intersecting box.

The following letter codes indicate limited use adapters:

**A** For use only with receptacles wired for 125V single-phase grounding service.

**B** For use only up to a maximum of 15A.

**C** For use only with receptacles wires for 15A/125V single-phase grounding service.

| RECEPTACLE<br>(FEMALE END) | PLUG (MALE END)     |                  |   |                  |                   |   |                   |                      |                      |
|----------------------------|---------------------|------------------|---|------------------|-------------------|---|-------------------|----------------------|----------------------|
|                            | 15A/125V<br>1-15    | 15A/125V<br>5-15 | 15A/125V <sup>1</sup><br>NON-NEMA         | 20A/125V<br>5-20 | 15A/125V<br>L5-15 | 15A/125V <sup>1</sup><br>NON-NEMA         | 20A/125V<br>L5-20 | 20A/125V<br>R&S PINS | 20A/250V<br>NON-NEMA |
| 15A/125V<br>1-15           |                     |                  | 1702<br>00380                             |                  | 1705              | 1704<br>00136                             | 1740              |                      | 1730                 |
| 15A/125V<br>5-15           | 1701 <sup>2</sup>   |                  | 1702 <sup>3</sup><br>00380 <sup>3</sup> C |                  | 1705              | 1704 <sup>3</sup><br>00136 <sup>3</sup> C | 1740              |                      | 1730                 |
| 15A/125V<br>NON-NEMA       |                     | 1706<br>00382    |   |                  |                   |   |                   |                      |                      |
| 20A/125V<br>5-20           |                     |                  |   |                  |                   |   | 1740              | 1733                 | 1730 A               |
| 15A/125V<br>L5-15          | 1793 <sup>3</sup>   | 1712             |   |                  |                   | 1725 C                                    | 1783              |                      |                      |
| 15A/125V<br>NON-NEMA       |                     | 1708<br>00137    |   |                  | 1719              |   |                   |                      |                      |
| 20A/125V<br>L5-20          | 1794 <sup>2</sup> B | 1744 B           |   | 1741             |                   |   |                   |                      |                      |
| 20A/250V<br>NON-NEMA       |                     | 1732 C           |   |                  |                   |   |                   |                      |                      |

<sup>1</sup> ALSO RATED 10A/250V

<sup>2</sup> WITH GROUNDING TAB

<sup>3</sup> FOR ADAPTER WIRING, REFER TO WIRING SCHEMATICS BELOW



MOST WOODHEAD PRODUCTS HAVE U.L. AND/OR CSA APPROVALS. FOR A LISTING OF APPROVALS BY PART NUMBER, SEE PAGES 262-269.

part no. 00136

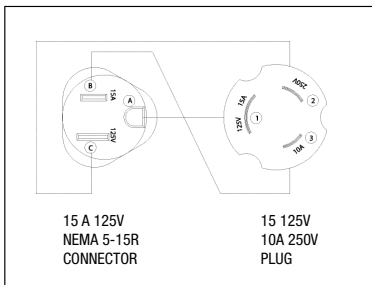

part no. 00380

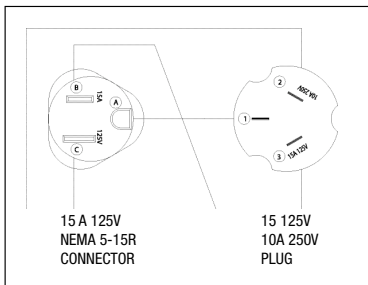

part no. 1702

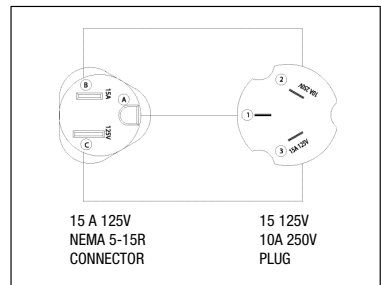

part no. 00137

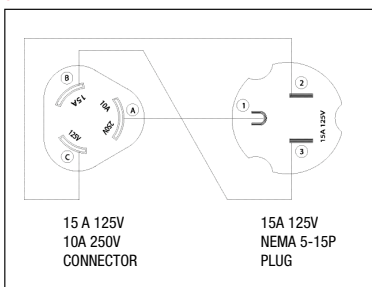

part no. 00382

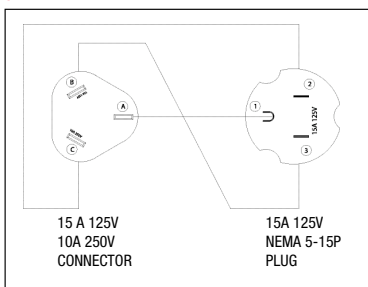

part no. 1704

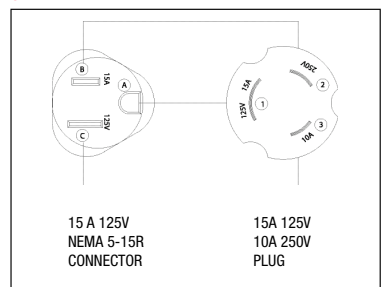

RECOMMENDED GROMMETS

Listed below and indicated by ● are the cord bushings (grommets) normally supplied with Watertite® devices. Other diameters are available if larger or smaller diameter grommets are required. For cord diameters, see page 126.

1/2" Cord Grip — F2 Body Size

| CORD DIAMETER | COLOR  | PART NO. | 14W04/         | 14W07/         | 14W19/         | 14W33/         | 14W34/         | 14W47/         | 14W48/         | 14W49/         | 24W07/         | 24W34/         | 24W47/         | 24W49/         | 26W07/         |
|---------------|--------|----------|----------------|----------------|----------------|----------------|----------------|----------------|----------------|----------------|----------------|----------------|----------------|----------------|----------------|
|               |        |          | 15W04<br>P. 48 | 15W07<br>P. 64 | 15W09<br>P. 48 | 15W33<br>P. 72 | 15W34<br>P. 72 | 15W47<br>P. 52 | 15W48<br>P. 60 | 15W49<br>P. 60 | 25W07<br>P. 64 | 25W34<br>P. 60 | 25W47<br>P. 52 | 25W49<br>P. 60 | 26W07<br>P. 68 |
| 0.062-0.125"  | BLACK  | 00-4978  |                |                |                |                |                |                |                |                |                |                |                |                |                |
| 0.125-0.187"  | YELLOW | 00-4970  |                |                |                |                |                |                |                |                |                |                |                |                |                |
| 0.187-0.250"  | ORANGE | 00-4971  |                |                |                |                |                |                |                |                |                |                |                |                |                |
| 0.250-0.312"  | BLACK  | 00-4972  |                |                |                |                |                |                |                |                |                |                |                |                |                |
| 0.312-0.375"  | GRAY   | 00-5263  | ●              | ●              | ●              | ●              | ●              | ●              | ●              | ●              | ●              | ●              | ●              | ●              | ●              |
| 0.375-0.437"  | GREEN  | 00-5264  | ●              | ●              | ●              | ●              | ●              | ●              | ●              | ●              | ●              | ●              | ●              | ●              | ●              |
| 0.437-0.500"  | ORANGE | 00-4975  |                |                |                |                |                |                |                |                |                |                |                |                |                |
| 0.500-0.562"  | BLACK  | 00-5266  | ●              | ●              | ●              | ●              | ●              | ●              | ●              | ●              | ●              | ●              | ●              | ●              | ●              |
| 0.562-0.625"  | GRAY   | 00-5267  | ●              | ●              | ●              | ●              | ●              | ●              | ●              | ●              | ●              | ●              | ●              | ●              | ●              |

3/4" Cord Grip — F3 Body Size

| CORD DIAMETER | COLOR  | PART NO. | 26W08/         | 26W47/         | 26W48/         | 26W49/         | 26W74/         | 26W75/         | 26W76/         | 26W81/         | 26W82/         | 26W83/         |
|---------------|--------|----------|----------------|----------------|----------------|----------------|----------------|----------------|----------------|----------------|----------------|----------------|
|               |        |          | 27W08<br>P. 80 | 27W47<br>P. 72 | 27W48<br>P. 72 | 27W49<br>P. 72 | 27W74<br>P. 84 | 27W75<br>P. 88 | 27W76<br>P. 88 | 27W81<br>P. 92 | 27W82<br>P. 92 | 27W83<br>P. 92 |
| 0.187-0.250"  | ORANGE | 00-4985  |                |                |                |                |                |                |                |                |                |                |
| 0.250-0.375"  | GRAY   | 00-4986  |                |                |                |                |                |                |                |                |                |                |
| 0.375-0.437"  | GREEN  | 00-4987  |                |                |                |                |                |                |                |                |                |                |
| 0.437-0.562"  | BLACK  | 00-4980  | ●              | ●              | ●              | ●              |                |                |                |                |                |                |
| 0.500-0.625"  | GRAY   | 00-4981  |                |                |                |                | ●              | ●              | ●              |                |                |                |
| 0.562-0.687"  | GREEN  | 00-4982  | ●              | ●              | ●              | ●              | ●              | ●              | ●              | ●              | ●              | ●              |
| 0.625-0.750"  | ORANGE | 00-4983  | ●              | ●              | ●              | ●              | ●              | ●              | ●              | ●              | ●              | ●              |
| 0.687-0.812"  | YELLOW | 00-4984  |                |                |                |                |                |                |                | ●              | ●              | ●              |

1" Cord Grip — F4 Body Size

| CORD DIAMETER | COLOR  | PART NO. | 26W09/         | 26W10/         | 28W08/          | 28W09/          | 28W47/         | 28W48/         | 28W49/         | 28W74/          | 28W75/          | 28W76/          | 28W77/          | 28W81/          | 28W82/          | 28W83/          |
|---------------|--------|----------|----------------|----------------|-----------------|-----------------|----------------|----------------|----------------|-----------------|-----------------|-----------------|-----------------|-----------------|-----------------|-----------------|
|               |        |          | 27W09<br>P. 80 | 27W10<br>P. 80 | 29W08<br>P. 100 | 29W09<br>P. 100 | 29W47<br>P. 96 | 29W48<br>P. 96 | 29W49<br>P. 96 | 29W74<br>P. 104 | 29W75<br>P. 108 | 29W76<br>P. 108 | 29W77<br>P. 108 | 29W81<br>P. 112 | 29W82<br>P. 112 | 29W83<br>P. 112 |
| 0.437-0.562"  | BLACK  | 00-4990  |                |                |                 |                 |                |                |                |                 |                 |                 |                 |                 |                 |                 |
| 0.500-0.625"  | GRAY   | 00-4991  |                |                |                 |                 |                |                |                |                 |                 |                 |                 |                 |                 |                 |
| 0.562-0.687"  | GREEN  | 00-4992  | ●              |                | ●               |                 | ●              | ●              | ●              |                 |                 |                 |                 |                 |                 |                 |
| 0.625-0.750"  | ORANGE | 00-4993  | ●              | ●              | ●               | ●               | ●              | ●              | ●              | ●               | ●               | ●               | ●               | ●               | ●               | ●               |
| 0.687-0.812"  | YELLOW | 00-4994  | ●              | ●              | ●               | ●               |                |                |                | ●               | ●               | ●               | ●               | ●               | ●               | ●               |
| 0.750-0.875"  | BLACK  | 00-4995  |                |                |                 |                 | ●              | ●              | ●              |                 |                 |                 |                 | ●               | ●               | ●               |
| 0.812-0.937"  | GRAY   | 00-4996  |                |                | ●               |                 | ●              | ●              | ●              |                 |                 |                 |                 |                 |                 |                 |
| 0.875-1.00"   | GREEN  | 00-4997  |                |                |                 |                 |                |                |                |                 |                 |                 |                 |                 |                 |                 |
| 1.00-1.10"    | BLACK  | 00-4998  | ●              | ●              | ●               | ●               | ●              | ●              | ●              | ●               | ●               | ●               | ●               | ●               | ●               | ●               |

1-1/4" Cord Grip — F5 Body Size

| CORD DIAMETER | COLOR  | PART NO. | CS63W61/63W61           | CS82W65           | 37W63           | CS84W65           | CS63W65/63W65           | CS83W65           | 37W65           | CS81W65           |
|---------------|--------|----------|-------------------------|-------------------|-----------------|-------------------|-------------------------|-------------------|-----------------|-------------------|
|               |        |          | CS63W60/63W60<br>P. 116 | CS82W64<br>P. 116 | 37W62<br>P. 116 | CS84W64<br>P. 116 | CS63W64/63W64<br>P. 118 | CS83W64<br>P. 118 | 37W64<br>P. 118 | CS81W64<br>P. 118 |
| 0.750-0.875"  | ORANGE | 00-5070  |                         |                   |                 |                   |                         |                   |                 |                   |
| 0.875-1.000"  | YELLOW | 00-5071  |                         |                   |                 |                   |                         |                   |                 |                   |
| 1.00-1.125"   | BLACK  | 00-5072  | ●                       | ●                 | ●               | ●                 | ●                       | ●                 | ●               | ●                 |
| 1.125-1.25"   | GREEN  | 00-5073  | ●                       | ●                 | ●               | ●                 | ●                       | ●                 | ●               | ●                 |
| 1.25-1.375"   | GRAY   | 00-5074  | ●                       | ●                 | ●               | ●                 | ●                       | ●                 | ●               | ●                 |

UL SP. MOST WOODHEAD PRODUCTS HAVE U.L. AND/OR CSA APPROVALS. FOR A LISTING OF APPROVALS BY PART NUMBER, SEE PAGES 262-269.

## TECHNICAL REFERENCE

Most Woodhead plugs, connectors, and receptacles are standard NEMA configurations. As such, standard terminal identification is used to incorporate these devices in the wiring system.

### Terminal Identification

| TERMINAL | LETTER DESIGNATION | DESCRIPTION        | CONDUCTOR                           |
|----------|--------------------|--------------------|-------------------------------------|
| GREEN    | G                  | GROUNDING TERMINAL | GREEN, GREEN W/YELLOW STRIPE        |
| WHITE    | W                  | GROUNDING TERMINAL | WHITE OR GRAY                       |
| X, Y, Z  | X, Y, Z            | HOT TERMINALS      | BLACK, RED, BLUE, ETC. <sup>1</sup> |

<sup>1</sup> THERE IS NO STANDARD THAT MATCHES COLOR TO LETTERS. ONCE A CORRELATION IS CHOSEN, IT SHOULD BE USED CONSISTENTLY.

### Electrical Rating Change on Non-NEMA Devices

Several years ago, Underwriters Laboratories was approached by a manufacturer with a request to list some non-NEMA configuration wiring devices – Woodhead's 2608, 2609, 2808 and 2809 configurations – in particular. U.L. agreed to list them only if they were marked for a single voltage current.

Because of the variety of applications, U.L. proceeded to take a survey on the different uses field. They determined that the majority are used in non-grounding applications. The following information was established:

2608, 2708, 26T08, 27T08, 26W08 and 27W08 – 20A 125/250V 3-Pole 3-Wire

2609, 2709, 26T09, 27T09, 26W09 and 27W09 – 20A 120/208V 4-Pole 4-Wire

2808, 2908, 28T08, 29T08, 28W08 and 29W08 – 30A 125/250V 3-Pole 3-Wire

2809, 2909, 28T09, 29T09, 28W09 and 29W09 – 30A 120/208V 4-Pole 4-Wire

Since Woodhead decided to mark the non-NEMA plugs and connectors single voltage and current rating, we have received many inquiries as to whether these devices still suitable at their old ratings.

The rating change was a “paperwork” change only. Although they now have a single rating, devices are certainly functional and can be used within the limitations of the old ratings.

These configurations are for replacement use only in existing facilities. Use of these devices under “premise control” where the user determines at what voltage these devices are to be within the building.

We changed our ratings when it was clear that the majority of other manufacturers were changing theirs, and having a different rating than everyone else would only add to the confusion.

### Watertite® Cord Diameter Range

| DIMENSIONAL REFERENCE INFORMATION | CORD DIAMETER RANGE       |
|-----------------------------------|---------------------------|
| F2                                | 0.062-0.625" (0.2-1.6 cm) |
| F3                                | 0.187-0.812" (0.5-2.1 cm) |
| F4                                | 0.437-1.10" (1.1-2.8 cm)  |
| F5                                | 0.875-1.375" (2.2-3.5 cm) |

### Super-Safeway® and Safeway® Cord Diameter Range

| DIMENSIONAL REFERENCE INFORMATION | CORD DIAMETER RANGE       |
|-----------------------------------|---------------------------|
| 2                                 | 0.300-0.675" (0.8-1.7 cm) |
| 3                                 | 0.325-0.840" (0.8-2.1 cm) |
| 4                                 | 0.425-1.150" (1.1-2.9 cm) |

NOTE: SEE CHART ON PAGE 123 FOR STANDARD GROMMETS.

**TECHNICAL REFERENCE** Horsepower Ratings

15 Amp NEMA Attachment Plugs and Receptacles

| AC VOLTAGE RATING | PHASES | POLES | HORSEPOWER RATING | NEMA CONFIGURATION       |
|-------------------|--------|-------|-------------------|--------------------------|
| 125VAC            | 1      | 2     | ½                 | 1-15, L1-15, 5-15, L5-15 |
| 250VAC            | 1      | 2     | 2                 | 6-15, L6-15, 7-15, L7-15 |

20 Amp NEMA Attachment Plugs and Receptacles

| AC VOLTAGE RATING | PHASES | POLES | HORSEPOWER RATING                        | NEMA CONFIGURATION      |
|-------------------|--------|-------|--|-------------------------|
| 125VAC            | 1      | 2     | 1  | 5-20, L5-20             |
| 250VAC            | 1      | 2     | 2  | L2-20, 6-20, L6-20      |
| 277VAC            | 1      | 2     | 2  | L7-20                   |
| 125/250VAC        | 1      | 3     | 2 L-L <sup>1</sup><br>1 L-N <sup>2</sup> | 10-20, L10-20<br>L14-20 |
| 250VAC            | 3      | 3     | 5  | L11-20, L15-20          |
| 480VAC            | 3      | 3     | 10                                       | L16-20                  |
| 120/208VAC        | 3      | 4     | 3  | L21-20                  |
| 277/480VAC        | 3      | 4     | 10                                       | L22-20                  |

30 Amp NEMA Attachment Plugs and Receptacles

| AC VOLTAGE RATING | PHASES | POLES | HORSEPOWER RATING  | NEMA CONFIGURATION |
|-------------------|--------|-------|--------------------|--------------------|
| 125VAC            | 1      | 2     | 2                  | L5-30              |
| 250VAC            | 1      | 2     | 3                  | L6-30              |
| 277VAC            | 1      | 2     | 3                  | L7-30              |
| 125/250VAC        | 1      | 3     | 2 L-N <sup>2</sup> | L14-30             |
| 250VAC            | 3      | 3     | 7-½                | L15-30             |
| 480VAC            | 3      | 3     | 15                 | L16-30             |
| 120/208VAC        | 3      | 4     | 5                  | L21-30             |
| 277/480VAC        | 3      | 4     | 15                 | L22-30             |

<sup>1</sup> L-L: MOTOR CONNECTED LINE-TO-LINE

<sup>2</sup> L-N: MOTOR CONNECTED LINE-TO-NEUTRAL

NOTE: HORSEPOWER RATINGS ARE NOT APPLICABLE TO DEVICES INCORPORATING OVERCURRENT PROTECTION. REFER TO ANSI/NEMA WD6-1988 FOR CONFIGURATIONS OF THE NEMA DESIGNATIONS.



## TECHNICAL REFERENCE

### Selecting the Proper Cord Size

1. Determine the load ampacity requirements.
2. Read across for the number of current-carrying conductors.
3. Read down until the value meets or exceeds the requirements established in Step 1.
4. Read back across to left to determine the appropriate size cord.

| AWG | 2 CURRENT-CARRYING CONDUCTORS | 3 CURRENT-CARRYING CONDUCTORS | 4-6 CURRENT-CARRYING CONDUCTORS |
|-----|-------------------------------|-------------------------------|---------------------------------|
| 22  | 3A                            | 3A                            | 3A                              |
| 18  | 10A                           | 7A                            | 5A                              |
| 16  | 13A                           | 10A                           | 8A                              |
| 14  | 18A                           | 15A                           | 12A                             |
| 12  | 25A                           | 20A                           | 16A                             |
| 10  | 30A                           | 25A                           | 20A                             |
| 8   | 40A                           | 35A                           | 28A                             |
| 6   | 55A                           | 45A                           | 36A                             |
| 4   | 70A                           | 60A                           | 48A                             |
| 2   | 95A                           | 80A                           | 64A                             |

<sup>1</sup> IN DETERMINING CORD CAPACITY, COUNT ONLY THOSE CONDUCTORS THAT ARE CURRENT-CARRYING. THE GROUNDING CONDUCTOR IS NOT COUNTED.

### Nominal Cord Diameter<sup>2</sup>

| AWG | 2 CONDUCTORS | 3 CONDUCTORS | 4 CONDUCTORS | 5 CONDUCTORS |
|-----|--------------|--------------|--------------|--------------|
| 22  | 0.215–0.235" | 0.215–0.235" | 0.240–0.260" | 0.250–0.270" |
| 18  | 0.340–0.385" | 0.360–0.400" | 0.385–0.430" | 0.460–0.510" |
| 16  | 0.365–0.410" | 0.385–0.430" | 0.410–0.460" | 0.490–0.550" |
| 14  | 0.495–0.550" | 0.520–0.575" | 0.560–0.620" | 0.630–0.705" |
| 12  | 0.565–0.625" | 0.590–0.655" | 0.640–0.710" | 0.700–0.770" |
| 10  | 0.615–0.685" | 0.650–0.720" | 0.700–0.775" | 0.760–0.840" |
| 8   | 0.780–0.880" | 0.830–0.930" | 0.925–1.050" | 1.000–1.150" |
| 6   | 0.920–1.050" | 0.970–1.100" | 1.050–1.200" | 1.180–1.330" |
| 4   | 1.060–1.210" | 1.130–1.280" | 1.250–1.450" | —            |
| 2   | 1.210–1.400" | 1.300–1.500" | 1.450–1.650" | —            |

<sup>2</sup> CORD TYPES S, SE, S00, S0, SE0, ST, ST00, AND ST0. INFORMATION FOR 2- THROUGH 18-AWG CORD TAKEN FROM U.L. STANDARD 62 "FLEXIBLE CORD AND FIXTURE WIRE." INFORMATION FOR 22 AWG CORD BASED ON WOODHEAD CORD.

NOTE: FOR FURTHER INFORMATION CONSULT TABLE 400-5 OF THE NATIONAL ELECTRICAL CODE.

## TECHNICAL REFERENCE Watertite® Pin and Sleeve Devices

### General Specifications

**Applications:** Temporary power systems, power disconnect for portable processing equipment, machinery intended for export and users of foreign-built equipment.

**Construction:**

- Type G nylon housing — watertight (IP67), impact-resistant, chemical-resistant.
- Type G nylon contact carrier.
- Deadfront construction.
- Self-adjusting split contact sleeves. Nickel-plated brass spring compensates for wear, maintains constant pressure along contact surface to ensure electrical continuity and grounding.
- Latching mechanism prevents accidental disengagement.
- Keyway for fast, accurate alignment.
- Internal strain relief with “swing away” feature.
- External strain relief reduces bending arc of cord.
- Large, identified terminals accept conductors one or two sizes larger or smaller than normal.
- “Onion ring” neoprene bushing in cord grip accommodates wide range of cord sizes.

**Approvals:** U.L. listed. CSA certified. Conforms to IEC 309-1 and 309-2 Standards.<sup>1</sup>

<sup>1</sup> IEC 309-1 AND 309-2 ARE A WORLDWIDE PIN AND SLEEVE STANDARD ESTABLISHED BY THE INTERNATIONAL ELECTROTECHNICAL COMMISSION. IT MEETS REQUIREMENTS OF SECTION 410-56(G) OF THE NATIONAL ELECTRICAL CODE.

### IEC 309 Pin and Sleeve Configuration and Color-Coding Standard

**Contact Positions:** The grounding contact position is based on a clock face. With the keyway at bottom, the female grounding contact will appear at one of the 12 clock positions. Example: all 480VAC receptacles and connectors, regardless of amperage, have their grounding sleeve at 7 o’clock (which puts the grounding pin on all mating plugs and inlets at 5 o’clock).

**Voltage Rating Color-Code:** The housings of every device in a particular voltage group are identical in color for instant identification. For example, all 480VAC devices are red, all 250VAC devices are blue.

**Amperage Rating Identification:** Amperage differences can be identified by the relative sizes of the devices. Smallest is 20A, largest is 100A.

### Woodhead Catalog Numbering System

| FIRST DIGIT | SECOND SERIES OF DIGITS | LETTER                         | THIRD DIGIT                                |
|-------------|-------------------------|--------------------------------|--|
| 3 = 3-WIRE  | 20 = 20A                | P = PLUG                       | CLOCK POSITION OF FEMALE GROUNDING CONTACT |
| 4 = 4-WIRE  | 30 = 30A                | R = RECEPTACLE                 |  |
| 5 = 5-WIRE  | 60 = 60A                | C = CONNECTOR                  |  |
|             | 100 = 100A              | B = INLET<br>BA = ANGLED INLET |  |

FOR EXAMPLE: 430R7W = WOODHEAD 4-WIRE, 30A RECEPTACLE WITH GROUND AT SEVEN O’CLOCK POSITION;  
430P7W = WOODHEAD 4-WIRE, 30A PLUG WHICH MATES WITH GROUND AT SEVEN O’CLOCK POSITION.

### Cord Grip Ranges

| PLUG AND CONNECTOR TYPE | CORD DIAMETER |        |
|-------------------------|---------------|--------|
|                         | MIN.          | MAX.   |
| 320                     | 0.395"        | 0.825" |
| 420                     | 0.395"        | 0.825" |
| 520                     | 0.395"        | 0.825" |
| 330                     | 0.395"        | 0.825" |

| PLUG AND CONNECTOR TYPE | CORD DIAMETER |       |
|-------------------------|---------------|-------|
|                         | MIN.          | MAX.  |
| 430                     | 0.710"        | 1.20" |
| 530                     | 0.710"        | 1.20" |
| 60A                     | 0.710"        | 1.50" |
| 100A                    | 0.950"        | 1.90" |





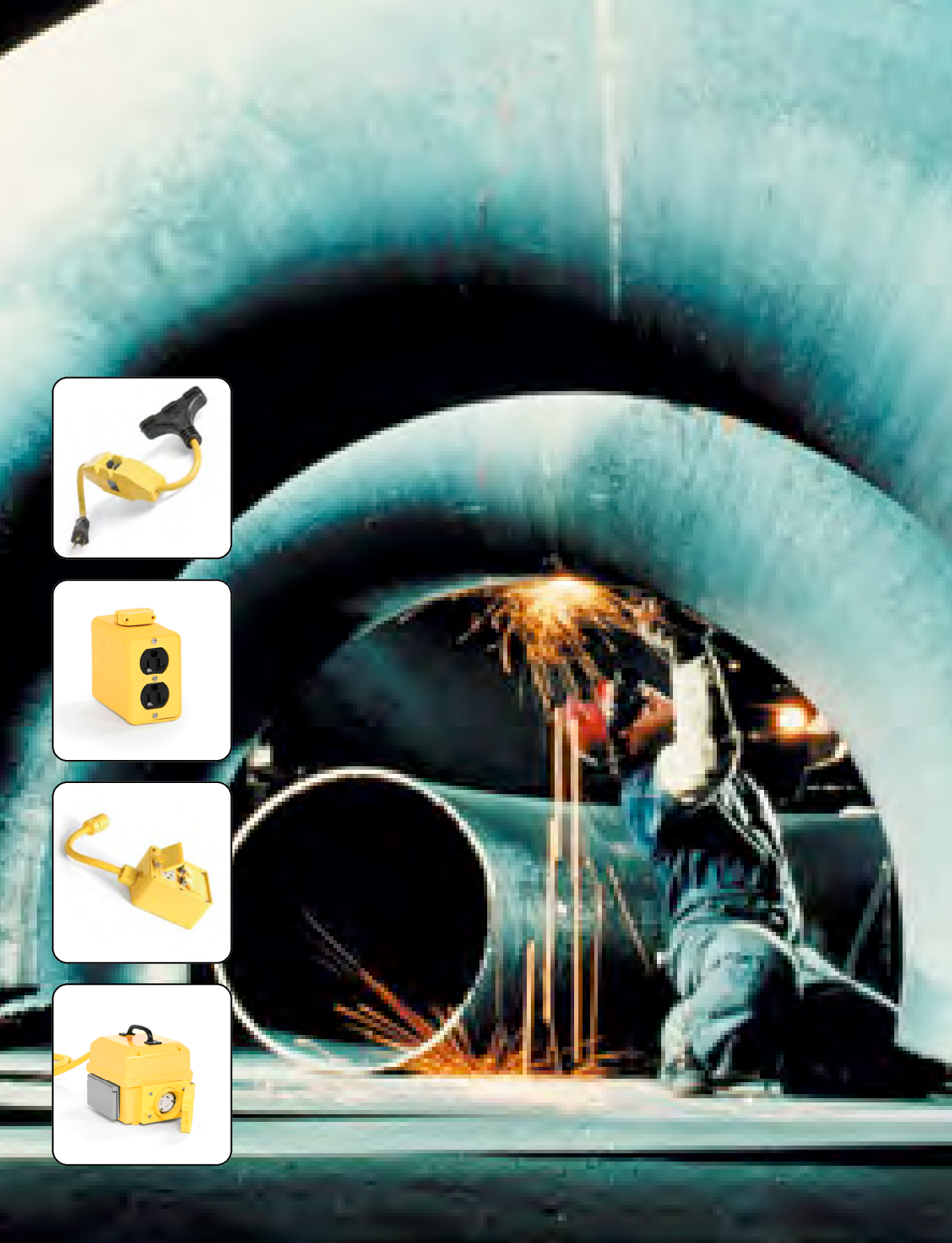



## PORTABLE OUTLET BOXES

Indoors and out, underfoot and overhead, portable power products from Woodhead are safe and dependable sources for temporary power distribution in virtually any environment. Workers count on our broad line of NEC and OSHA compliant industrial grade portable outlet boxes to get the job done, no matter how tough the conditions.

Exceptionally durable and highly impact-resistant, yet lightweight and easy to transport, Woodhead industrial grade boxes are the ideal combination of strength and functionality. Each non-conductive enclosure is formed of sturdy NEOTEX<sup>®</sup> rubber which resists oil, shock and chemicals.

Woodhead manufactures portable power products in two families:

### **GFCI products**

For construction sites and other rugged industrial settings, Woodhead portable GFCI products are equipped with an open-neutral relay that meets OSHA requirements to safeguard workers and employees against ground faults. Watertite<sup>®</sup> GFCI outlet boxes of long lasting NEOTEX rubber are engineered specifically for use in oil refineries, shipyards and other work sites where dampness, moisture and dust are present, including areas where frequent hosedown is required.

### **Multiple Outlet Boxes**

Virtually anyplace portable power is required; Woodhead is ready with solutions that deliver years of rugged service. The multiple outlet box product offering ranges from single or double duplex receptacle solutions to multi-tap outlet boxes for numerous plug-in applications. Available in various configurations, for a wide array of environments, Woodhead can provide an outlet box that meets your specific needs.

In addition to the user- and factory-installed portable power products featured in this catalog, Woodhead can provide a custom-built outlet box that adapts to your application. Call on our expertise for custom distributed power set-ups for exhibitions, conventions and other temporary power requirements. Contact your local Woodhead representative to discuss your needs.



# PORTABLE OUTLET BOXES

## INLINE GFCI

Woodhead's Safe-T-Chek® GFCI products feature a manual reset which must be activated after a power outage or a ground fault condition, and serves to prevent the potential risk of unmonitored equipment start-up. Additionally, contacts are spring-loaded to assure more consistent conductivity and extend the life of each GFCI device. Woodhead offers a complete series of OSHA – and NEC compliant portable 15, 20, and 30 Amp ground fault circuit interrupter products ranging from protected cordsets to outlet boxes and tri-tap outlets.



### Molded Plug/Connector

| NEMA             | AMPS/HZ/VOLTS      | CORD TYPE/LENGTH | PART NO.                 |
|------------------|--------------------|------------------|--------------------------|
| INLINE GFCI ONLY | 15A 50/60HZ 120VAC | —                | 20054                    |
| 5-15             | 15A 50/60HZ 120VAC | 14/3 SJTW 18"    | 15050-1                  |
|                  |                    | 14/3 SJTW 6'     | 15050-6                  |
|                  |                    | 14/3 SJTW 25'    | 15050-25                 |
| 5-20             | 20A 50/60HZ 120VAC | —                | GFCI-INLINE <sup>1</sup> |

<sup>1</sup> 120/240 VAC

### Molded Plug/Tri-Cord

| NEMA | AMPS/HZ/VOLTS      | CORD TYPE/LENGTH | PART NO.   |
|------|--------------------|------------------|------------|
| 5-15 | 15A 50/60HZ 120VAC | 12/3 SJTW 2'     | 15050-3TT  |
|      |                    | 12/3 SJTW 6'     | 15050-6TT  |
|      |                    | 12/3 SJTW 25'    | 15050-25TT |
|      |                    | 12/3 SJTW 50'    | 15050-50TT |



### Watertite® Plug/Connector

| NEMA             | AMPS/HZ/VOLTS      | CORD TYPE/LENGTH | PART NO.                 |
|------------------|--------------------|------------------|--------------------------|
| INLINE GFCI ONLY | 15A 50/60HZ 120VAC | —                | 20054                    |
| 5-15             | 15A 50/60HZ 120VAC | 14/3 SJTW 18"    | 15052-1                  |
|                  |                    | 14/3 SJTW 6'     | 15052-6                  |
|                  |                    | 14/3 SJTW 25'    | 15052-25                 |
| 5-20             | 20A 50/60HZ 120VAC | —                | GFCI-INLINE <sup>1</sup> |
|                  |                    | 12/3 SJTW 18"    | 20052-1                  |
|                  |                    | 12/3 SJTW 6'     | 20052-6                  |
|                  |                    | 12/3 SJTW 25'    | 20052-25                 |
| L6-20            | 20A 50/60HZ 240V   | 12/3 SJTW 1'     | 20055-1                  |
|                  |                    | 12/3 SJTW 6'     | 20055-6                  |
|                  |                    | 12/3 SJTW 25'    | 20055-25                 |
| L5-30            | 30A 50/60HZ 120V   | 10/3 SJTW 1'     | 30052-1                  |
|                  |                    | 10/3 SJTW 6'     | 30052-6                  |
| L6-30            | 30A 50/60HZ 240V   | 10/3 SJTW 1'     | 30054-1                  |
|                  |                    | 10/3 SJTW 6'     | 30054-6                  |
|                  |                    | 10/3 SJTW 25'    | 30054-25                 |

<sup>1</sup> 120/240 VAC

### Super-Safeway® Plug/Connector

| NEMA             | AMPS/HZ/VOLTS      | CORD TYPE/LENGTH | PART NO.                 |
|------------------|--------------------|------------------|--------------------------|
| INLINE GFCI ONLY | 15A 50/60HZ 120VAC | —                | 20054                    |
| 5-15             | 15A 50/60HZ 120VAC | 14/3 SJTW 18"    | 15051-1                  |
|                  |                    | 14/3 SJTW 6'     | 15051-6                  |
|                  |                    | 14/3 SJTW 25'    | 15051-25                 |
| 5-20             | 20A 50/60HZ 120VAC | —                | GFCI-INLINE <sup>1</sup> |
|                  |                    | 12/3 SJTW 18"    | 20051-1                  |
|                  |                    | 12/3 SJTW 6'     | 20051-6                  |
|                  |                    | 12/3 SJTW 25'    | 20051-25                 |
| L6-20            | 20A 50/60HZ 240V   | 12/3 SJTW 1'     | 20054-1                  |
|                  |                    | 12/3 SJTW 6'     | 20054-6                  |
|                  |                    | 12/3 SJTW 25'    | 20054-25                 |
| L5-30            | 30A 50/60HZ 120VAC | 10/3 SJTW 1'     | 30051-1                  |
|                  |                    | 10/3 SJTW 6'     | 30051-6                  |
| L6-30            | 30A 50/60HZ 240VAC | 10/3 SJTW 1'     | 30053-1                  |
|                  |                    | 10/3 SJTW 6'     | 30053-6                  |
|                  |                    | 10/3 SJTW 25'    | 30053-25                 |

<sup>1</sup> 120/240 VAC

### Weather-Resistant Outlet Box

with two flip lid protected duplex receptacles and a primary Watertite® plug.



| NEMA | AMPS/HZ/VOLTS      | CORD TYPE/LENGTH | PART NO. |
|------|--------------------|------------------|----------|
| 5-20 | 20A 50/60HZ 120VAC | 12/3 SJTW 18"    | 20053W-2 |

### Outlet Box

with two duplex receptacles and a primary Super-Safeway plug.



| NEMA | AMPS/HZ/VOLTS      | CORD TYPE/LENGTH | PART NO. |
|------|--------------------|------------------|----------|
| 5-20 | 20A 50/60HZ 120VAC | 12/3 SJTW 18"    | 20053-2  |

MOST WOODHEAD PRODUCTS HAVE U.L. AND/OR CSA APPROVALS. FOR A LISTING OF APPROVALS BY PART NUMBER, SEE PAGES 262-269.

**INLINE GFCI**

Woodhead offers cost effective protection featuring one GFCI duplex receptacle and an optional ground continuity monitor or a sealed weather-resistant feed-through rubber enclosure for damp and wet environments. One side of the enclosure accommodates an open-neutral sensing relay which detects and prevents operation under life-threatening conditions. MAX-LOC® cord grip (F3) is standard on both series of boxes.

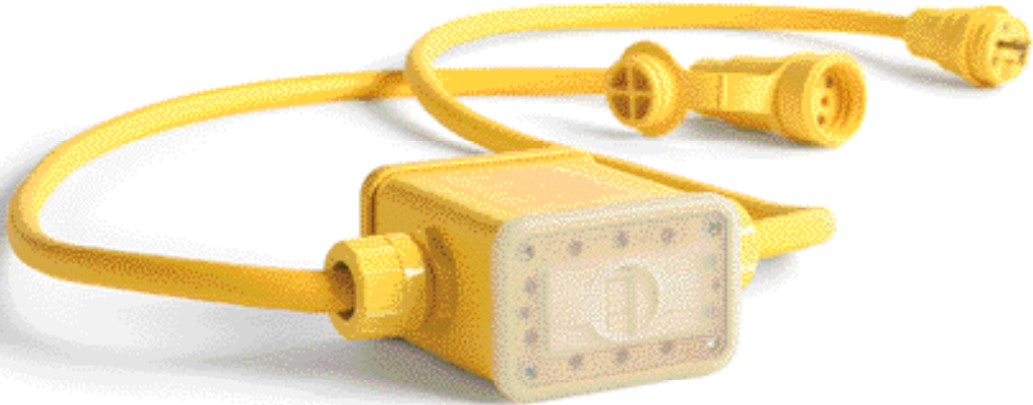

**Watertite® In-line GFCI**

with Watertite® plug/connector, weather-resistant enclosure and 6 ft. 12 gauge/3 conductor SOOW cord. No receptacle.

| CONFIGURATION | AMPS/HZ/VOLTS    | PART NO.    |
|---------------|------------------|-------------|
| NEMA 5-15     | 15A 50/60HZ 120V | 3070W-GFI   |
| NEMA 5-20     | 20A 50/60HZ 120V | 3070W-GFI20 |



**Super-Safeway® In-line GFCI**

with Super-Safeway plug/connector, receptacle with flip lid and 6 ft. 12 gauge/3 conductor SOOW cord.

| CONFIGURATION | AMPS/HZ/VOLTS    | WITH GROUND CONTINUITY MONITOR | PART NO.    |
|---------------|------------------|--------------------------------|-------------|
| NEMA 5-15     | 15A 50/60HZ 120V | ●                              | 3080F-GFI   |
| NEMA 5-15     | 15A 50/60HZ 120V |                                | 3070F-GFI   |
| NEMA 5-20     | 20A 50/60HZ 120V | ●                              | 3080F-GFI20 |

MOST WOODHEAD PRODUCTS HAVE U.L. AND/OR CSA APPROVALS. FOR A LISTING OF APPROVALS BY PART NUMBER, SEE PAGES 262-269.

# PORTABLE OUTLET BOXES

## GFCI PLUG

Woodhead's Safe-T-Chek® GFCI attachable plug products feature a manual reset which must be activated after a power outage or a ground fault condition, and serves to prevent the potential risk of unmonitored equipment start-up. Additionally, contacts are spring-loaded to assure more consistent conductivity and extend the life of each GFCI device. Woodhead offers a complete series of OSHA – and NEC compliant portable 15 amp ground fault circuit interrupter plug products ranging from protected cordsets to outlet boxes.

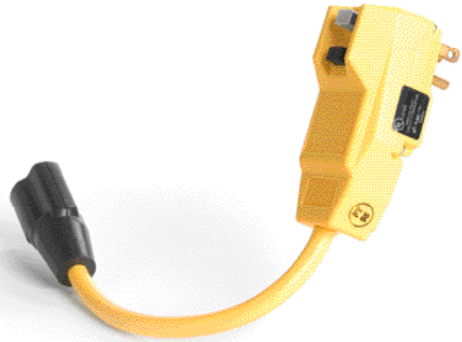

### User Attachable GFCI Plug

| NEMA CONFIG. | AMPS/HZ/VOLTS      | CORD TYPE | CORD LENGTH | PART NO. |
|--------------|--------------------|-----------|-------------|----------|
| 5-15 (1)(1)  | 15A 50/60HZ 120VAC | —         | —           | 15054    |

### GFCI Plug with pigtail and molded connector

| NEMA CONFIG. | AMPS/HZ/VOLTS      | CORD TYPE | CORD LENGTH | PART NO. |
|--------------|--------------------|-----------|-------------|----------|
| 5-15 (1)(1)  | 15A 50/60HZ 120VAC | 14/3 SJTW | 9"          | 15054-1  |

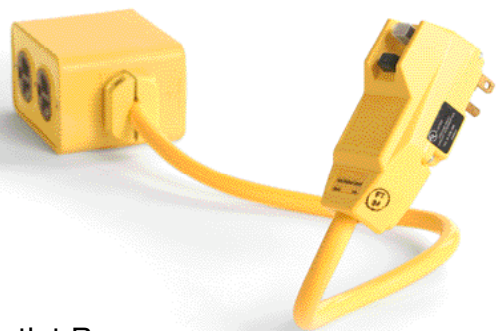
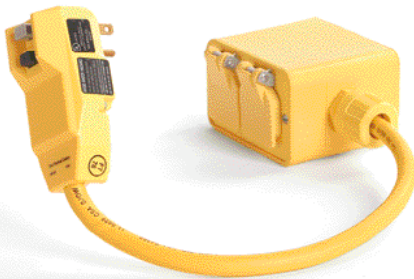

### Weather-Resistant Outlet Box

GFCI plug and outlet box containing two duplex receptacles

| NEMA CONFIG. | AMPS/HZ/VOLTS      | CORD TYPE | CORD LENGTH | PART NO.  |
|--------------|--------------------|-----------|-------------|-----------|
| 5-15 (1)(1)  | 15A 50/60HZ 120VAC | 12/3 SJTW | 18"         | 15053W-2  |
|              |                    | 12/3 SJTW | 25'         | 15053W-25 |
|              |                    | 12/3 SJTW | 50'         | 15053W-50 |

### Outlet Box

GFCI plug with outlet box containing two duplex receptacles

| NEMA CONFIG. | AMPS/HZ/VOLTS      | CORD TYPE | CORD LENGTH | PART NO. |
|--------------|--------------------|-----------|-------------|----------|
| 5-15 (1)(1)  | 15A 50/60HZ 120VAC | 12/3 SJTW | 18"         | 15053-2  |
|              |                    | 12/3 SJTW | 25'         | 15053-25 |
|              |                    | 12/3 SJTW | 50'         | 15053-50 |



UL SP MOST WOODHEAD PRODUCTS HAVE U.L. AND/OR CSA APPROVALS. FOR A LISTING OF APPROVALS BY PART NUMBER, SEE PAGES 262-269.

## GFCI PLUG

A two-piece nylon box featuring a brass buss bar, manual reset type circuit breaker, Woodhead's industrial grade 15A straight blade duplex receptacles and a MAX-LOC® cord grip (F2) comes wired with 8 ft. of 14/3 SJOOW cord<sup>1</sup> and optional right angled 3 - prong GFCI plug and/or surge protection.



### Multi-Tap® Boxes with surge-protected or GFCI-protected duplex receptacles

| CONFIGURATION   | NUMBER OF DUPLEX | AMPS/HZ/VOLTS      | WITH SURGE PROTECTION | WITH GFCI PROTECTION | WITH SURGE & GFCI PROTECTION |
|---|------------------|--------------------|-----------------------|----------------------|------------------------------|
| NEMA 5-15  | 2                | 15A 50/60HZ 120VAC | 3500S                 | 3500PLG              | 3500SPLG                     |
| NEMA 5-15  | 3                | 15A 50/60HZ 120VAC | 3510S                 | 3510PLG              | 3510SPLG                     |

<sup>1</sup> 3500S AND 3510S FEATURE S00W CORD.



MOST WOODHEAD PRODUCTS HAVE U.L. AND/OR CSA APPROVALS.  
FOR A LISTING OF APPROVALS BY PART NUMBER, SEE PAGES 262-269.

# PORTABLE OUTLET BOXES

## GFCI OUTLET BOXES

Woodhead offers cost effective GFCI protection featuring ground continuity monitors and duplex receptacles for either industrial, heavy-duty use or wet/damp locations. One side of the enclosure accommodates an open-neutral sensing relay which detects and prevents operation under life-threatening conditions. MAX-LOC® cord grip (F3) is standard on both series of boxes and the GFCI protected FD outlet box features additional wire mesh strain relief.

### Super-Safeway® Outlet Boxes

with 15 or 20 amp GFCI duplex receptacle with flip lid and ground continuity monitor. 6 ft. 12 gauge/3 conductor SOOW cord

| CONFIGURATION | AMPS/HZ/VOLTS    | PART NO.                          |
|---------------|------------------|-----------------------------------|
| NEMA 5-15     | 15A 50/60HZ 120V | 3070-GFI <sup>1</sup><br>3080-GFI |
| NEMA 5-20     | 20A 50/60HZ 120V | 3080-GFI20                        |

<sup>1</sup> DOES NOT INCLUDE GROUND CONTINUITY MONITOR

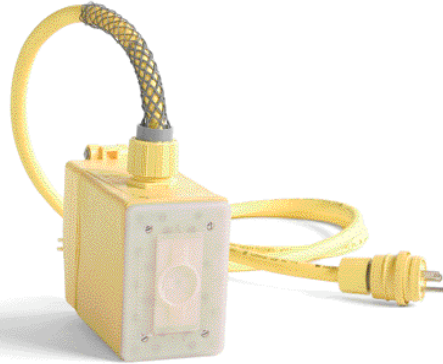
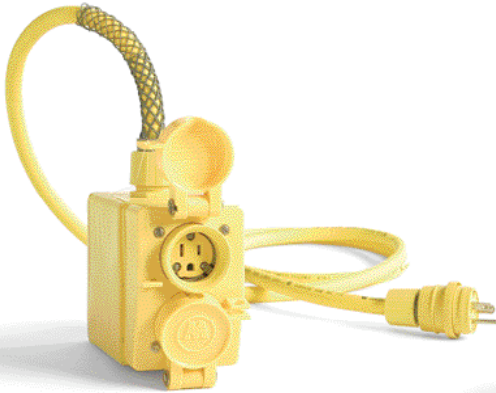
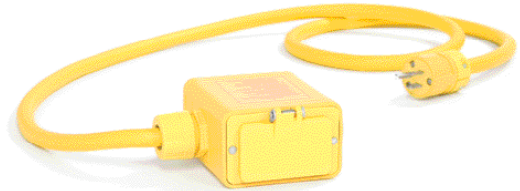

### Watertite® GFCI Duplex FD Outlet Box

NEōTEX® rubber FD boxes with GFCI protection, with or without cord and ground continuity monitor. When properly mated with a Woodhead Watertite® plug, the receptacle connection meets the requirements of NEMA Type 4X.

| CONFIGURATION | AMPS/HZ/VOLTS    | WITH CORD, RECEPTACLE & PLUG | CORD TYPE | WITH GROUND CONTINUITY MONITOR | WITHOUT GROUND CONTINUITY MONITOR |
|---------------|------------------|------------------------------|-----------|--------------------------------|-----------------------------------|
| NEMA 5-15     | 15A 50/60HZ 120V |                              | —         | —                              | 3301GF                            |
|               |                  |                              | 14/3 SOOW | 3301GGF_143                    | 3301GF_143                        |
| NEMA L5-15    | 15A 50/60HZ 120V |                              | —         | —                              | 3302GF                            |
|               |                  |                              | 14/3 SOOW | 3302GGF_143                    | 3302GF_143                        |
| NEMA 5-20     | 20A 50/60HZ 120V |                              | —         | —                              | 3304GF                            |
|               |                  |                              | 12/3 SOOW | 3304GGF_123                    | 3304GF_123                        |

**Primary Cord Length:** Use the following chart to specify the length of the primary cord.

3301GGF L 143

| CORD LENGTH |   |
|-------------|---|
| 6' .....    | L |
| 25' .....   | A |
| 50' .....   | B |
| 100' .....  | D |

MOST WOODHEAD PRODUCTS HAVE U.L. AND/OR CSA APPROVALS. FOR A LISTING OF APPROVALS BY PART NUMBER, SEE PAGES 262-269.



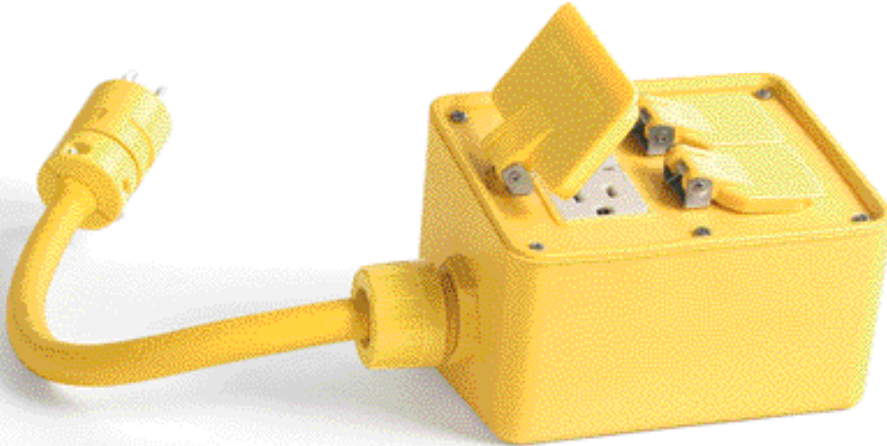

GFCI OUTLET BOXES

This heavy-duty angled outlet box of molded NEOTEK® rubber with a non-metallic, weather-resistant cover, accommodates two duplex, or one duplex and one single receptacle, all protected by spring-loaded flip lid covers and GFCI. This box also features an open-neutral sensing relay which detects and prevents operation under life-threatening conditions. The angled design provides a natural arc of bend strain relief for any tools, cordsets, or lighting product it is powering and protecting. The MAX-LOC® cord grip (F3) secures the high quality 12/3 S00W cable used on this product.



Angled GFCI Outlet Box



4-outlet GFCI protected boxes with one or two duplex receptacles, Super-Safeway® plug and a 12 gauge/3 conductor SOW cord

| CONFIGURATION  | AMPS/HZ/VOLTS    | LOCKING BLADE (L) | STANDARD BOX | STANDARD BOX WITH CONTINUITY MONITOR | FEED-THRU BOX <sup>1</sup> | FEED-THRU BOX WITH CONTINUITY MONITOR <sup>1</sup> |
|--|------------------|-------------------|--------------|--------------------------------------|----------------------------|--|
| NEMA 5-15<br>         | 15A 50/60HZ 120V |                   | 3320_123     | 3327_123                             | 3320F_123                  | 3327F_123  |
| NEMA 5-15 & L5-15<br> | 15A 50/60HZ 120V | ●                 | 3321_123     | 3323_123                             | 3321F_123                  | 3323F_123  |
| NEMA 5-20<br>         | 20A 50/60HZ 120V |                   | 3322_123     | 3324_123                             | 3322F_123                  | 3324F_123  |
| NEMA 5-20 & L5-20<br> | 20A 50/60HZ 120V | ●                 | 3325_123     | 3326_123                             | 3325F_123                  | 3326F_123  |

<sup>1</sup> FEED-THRU VERSIONS COME COMPLETE WITH 6 FEET OF SECONDARY CORD

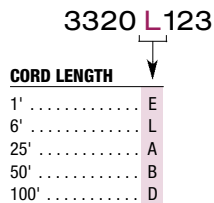
Primary Cord Length: Use the following chart to specify the length of the primary cord.



  MOST WOODHEAD PRODUCTS HAVE U.L. AND/OR CSA APPROVALS. FOR A LISTING OF APPROVALS BY PART NUMBER, SEE PAGES 262-269.



## PORTABLE OUTLET BOXES

### GFCI OUTLET BOXES

This heavy-duty GFCI outlet box of molded NEOTEX® rubber with non-metallic or rubber coated metal cover plates, accommodate two single, two duplex, or three single receptacles protected by a GFCI switch. This box also features an open-neutral sensing relay which detects and prevents operation under life-threatening conditions. The Watertite® receptacles are protected by rubber closure caps when they are not in use. The MAX-LOC® cord grip (F3) secures the high quality 12/3 SOOW cable used on this product with Super-Safeway® plugs on weather-resistant versions and Watertite® plugs on the wet location product.

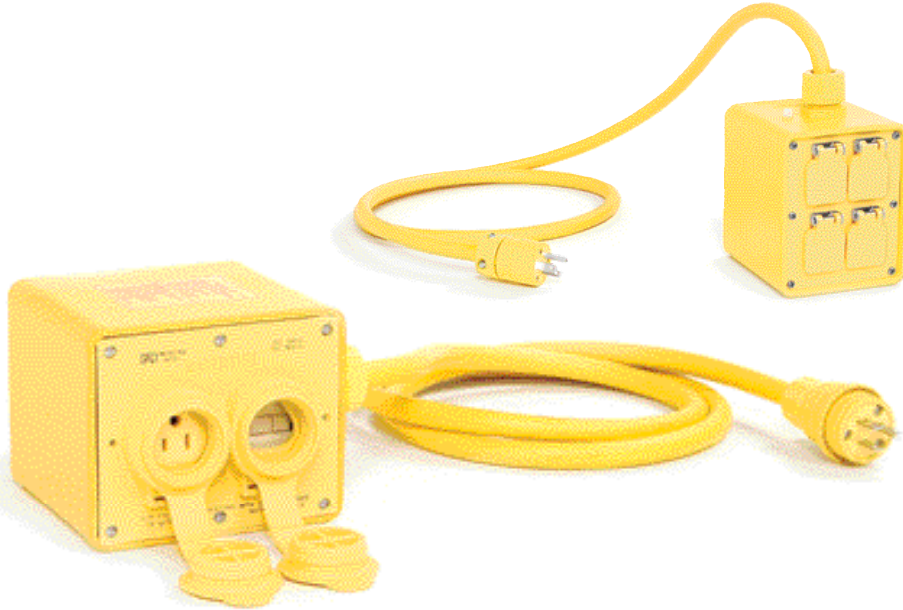

#### Heavy-Duty GFCI Outlet Box

With weather-resistant flip lids and primary Super-Safeway Plugs or Watertite® outlets with primary Watertite® plugs. 12 gauge, 3 conductor SOOW cord. Weather-resistant flip lid products contain two duplex receptacles or 4 outlets.

| CONFIGURATION | AMPS/HZ/VOLTS    | WEATHER-RESISTANT FLIP LIDS       |                                | WATERTITE OUTLETS |                    |
|---------------|------------------|-----------------------------------|--------------------------------|-------------------|--------------------|
|               |                  | WITHOUT GROUND CONTINUITY MONITOR | WITH GROUND CONTINUITY MONITOR | WITH TWO OUTLETS  | WITH THREE OUTLETS |
| NEMA 5-15     | 15A 50/60HZ 120V | 32G15_123                         | 32GM15_123                     | 32HG15_123        | 32WG15_123         |
| NEMA 5-20     | 20A 50/60HZ 120V | 32G20_123                         | 32GM20_123                     | 32HG20_123        | 32WG20_123         |

Primary Cord Length: Use the following chart to specify the length of the primary cord.

32G15 L123

↓

| CORD LENGTH |   |
|-------------|---|
| 6' .....    | L |
| 25' .....   | A |
| 50' .....   | B |

MOST WOODHEAD PRODUCTS HAVE U.L. AND/OR CSA APPROVALS. FOR A LISTING OF APPROVALS BY PART NUMBER, SEE PAGES 262-269.

## GFCI OUTLET BOXES

Woodhead GFCI flexible solutions are available with portable workstations and drop-down pendant boxes. Workstations are molded of high strength, non-conductive, glass-reinforced polyester while pendant boxes deliver power to remote locations with NEOTEX® rubber enclosures and Watertite® duplex receptacles which meet the requirements of NEMA type 4X when properly mated with a Woodhead Watertite® plug. GFCI pendant stations also feature proper strain and support relief with wire mesh grips for proper installation. These boxes also feature an open-neutral sensing relay which detects and prevents operation under life-threatening conditions.

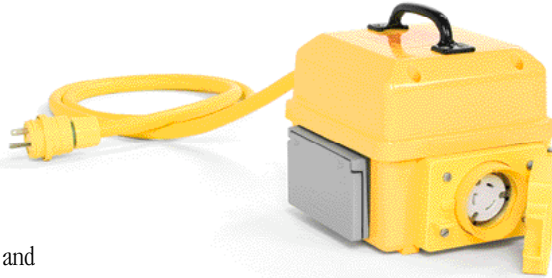

**GFCI Portable Workstation**  
with 6 ft. 12 gauge, 3 conductor SOOW cord and  
125V straight-blade plug

| PLUG CONFIG.     | SIDE A GFCI CONFIGURATION | SIDE B CONFIGURATION    | SIDE C CONFIGURATION    | AMPS/HZ/VOLTS    | PART NO. |
|------------------|---------------------------|-------------------------|-------------------------|------------------|----------|
| NEMA 5-15 (Ⓢ)(Ⓢ) | DUPLEX NEMA 5-15          | DUPLEX NEMA 5-15 (Ⓢ)(Ⓢ) | DUPLEX NEMA 5-15 (Ⓢ)(Ⓢ) | 15A 50/60HZ 120V | 3493     |
| NEMA 5-20 (Ⓢ)(Ⓢ) | DUPLEX NEMA 5-20          | DUPLEX NEMA 5-20 (Ⓢ)(Ⓢ) | DUPLEX NEMA 5-20 (Ⓢ)(Ⓢ) | 20A 50/60HZ 120V | 3494     |
| NEMA 5-20 (Ⓢ)(Ⓢ) | DUPLEX NEMA 5-20          | SINGLE NEMA L5-20 (Ⓢ)   | SINGLE NEMA L5-20 (Ⓢ)   | 20A 50/60HZ 120V | 3492     |



MOST WOODHEAD PRODUCTS HAVE U.L.  
AND/OR CSA APPROVALS.  
FOR A LISTING OF APPROVALS BY PART  
NUMBER, SEE PAGES 262-269.

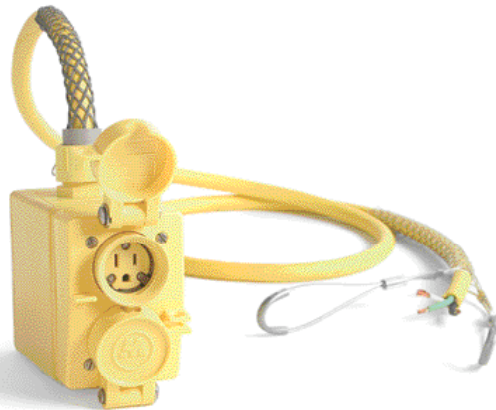

**GFCI Pendant Boxes<sup>1</sup>**  
Pre-wired GFCI protected pendant boxes with  
Watertite® duplex or single receptacles

| CONFIGURATION     | AMPS/HZ/VOLTS    | DUPLEX FLIP LIDS<br>AND RECEPTACLES | SINGLE FLIP LIDS<br>AND RECEPTACLES | LOCKING<br>BLADE (L) | CORD<br>TYPE | PART NO.    |
|-------------------|------------------|-------------------------------------|-------------------------------------|----------------------|--------------|-------------|
| NEMA 5-15 (Ⓢ)(Ⓢ)  | 15A 50/60HZ 120V | ●                                   |                                     |                      | 14/3 SOOW    | 70W47_143GF |
| NEMA L5-15 (Ⓢ)(Ⓢ) | 15A 50/60HZ 120V | ●                                   |                                     | ●                    | 14/3 SOOW    | 75W47_143GF |
| NEMA 5-20 (Ⓢ)(Ⓢ)  | 20A 50/60HZ 120V | ●                                   |                                     |                      | 12/3 SOOW    | 70W33_123GF |
| NEMA L5-20 (Ⓢ)(Ⓢ) | 20A 50/60HZ 120V |                                     | ●                                   | ●                    | 12/3 SOOW    | 77W47_123GF |

<sup>1</sup> GFCI PENDANT BOXES DO NOT FEATURE OPEN-NEUTRAL SENSING RELAY

**Primary Cord Length:** Use the following chart to specify the length of the primary cord.

70W47 **L** 143GF

**CORD LENGTH**

|           |   |
|-----------|---|
| 6' .....  | L |
| 15' ..... | M |
| 25' ..... | A |

# PORTABLE OUTLET BOXES

## MULTIPLE OUTLET BOXES – 3000 Series

Woodhead's Super-Safeway® duplex and single receptacle outlet boxes are listed for portable usage and provide the safety and reliability required on today's job sites. Made of durable NEOTEX® rubber to withstand the impact of drops, bumps, and other damage consistent with industrial use, these boxes provide the peace of mind that their exterior will not become energized by loose wire contacts, unlike common metal junction boxes. Standard depth 3-3/8" and extended depth 4-3/8" boxes accommodate multiple receptacle types with various degrees of weather protection. Choose pre-wired Woodhead solutions or make your own portable power outlet box. Spring-loaded flip lid boxes feature MAX-LOC® cord grips while standard outlet boxes come with a screw-tight cord clamp.



### Super-Safeway Standard Depth Outlet Box (3-3/8") with two duplex or two single receptacles

| CONFIGURATION                          | WITH PLUG AND<br>14/3 AWG CORD | TWO DUPLEX OUTLET BOX   |                       | TWO SINGLE OUTLET BOX |                       |
|--|--------------------------------|-------------------------|-----------------------|-----------------------|-----------------------|
|  |                                | STANDARD                | WITH FLIP LIDS (F2)   | STANDARD              | WITH FLIP LIDS (F2)   |
| NEMA 5-15                              | ●                              | 3000-1<br>3000-1_143'   | 3005-1<br>3005-1_143' | —                     | —                     |
| NEMA 5-20                              | ● 12/3 AWG                     | 3000-10<br>3000-10_123' | —                     | —                     | —                     |
| NEMA L1-15                             | ●                              | 3000-6<br>3000-6_142'   | 3005-6<br>3005-6_142' | —                     | —                     |
| NEMA L5-15                             | ●                              | 3000-2<br>3000-2_143'   | 3005-2<br>3005-2_143' | 3001-2<br>3001-2_143' | 3006-2<br>3006-2_143' |
| NON-NEMA                               | ●                              | 3000-8<br>3000-8_143'   | 3005-8<br>3005-8_143' | —                     | —                     |
| WITH COVERPLATE ONLY<br>1.39" DIAMETER |                                | 3000                    | 3005                  | —                     | —                     |
| 1.56" DIAMETER                         |                                | —                       | —                     | 3001<br>3003          | 3006<br>3008          |
| <b>CORD DIAMETER RANGES</b>            |                                | 0.325-0.655"            | 0.312-0.625"          | 0.325-0.655"          | 0.312-0.625"          |

### Super-Safeway Extended Depth Outlet Box (4-3/8") with two duplex or two single receptacles

| CONFIGURATION                          | WITH PLUG AND<br>12/3 SOW CORD | TWO DUPLEX OUTLET BOX   |                         | TWO SINGLE OUTLET BOX |                     |
|--|--------------------------------|-------------------------|-------------------------|-----------------------|---------------------|
|  |                                | STANDARD                | WITH FLIP LIDS (F3)     | STANDARD              | WITH FLIP LIDS (F3) |
| NEMA 5-15                              |                                | 3080-1                  | 3085-1                  | —                     | —                   |
| NEMA 5-20                              | ●                              | 3080-10<br>3080-10_123' | 3085-10<br>3085-10_123' | —                     | —                   |
| NEMA L1-15                             |                                | 3080-6                  | 3085-6                  | —                     | —                   |
| NEMA L5-15                             |                                | 3080-2                  | 3085-2                  | 3081-2                | 3086-2              |
| NEMA L2-20                             |                                | —                       | —                       | 3081-7                | 3086-7              |
| NEMA L5-20                             | ●                              | —                       | —                       | 3081-7_122'           | 3086-7_122'         |
| NON-NEMA                               | ●                              | —                       | —                       | 3083-3                | 3088-3              |
|  | ●                              | —                       | —                       | 3083-3_123'           | 3088-3_123'         |
| NON-NEMA                               |                                | 3080-8                  | 3085-8                  | —                     | —                   |
|  | ●                              | —                       | —                       | 3083-9                | 3088-9              |
|  |                                | —                       | —                       | 3083-9_123'           | 3088-9_123'         |
| WITH COVERPLATE ONLY<br>1.39" DIAMETER |                                | 3080                    | 3085                    | —                     | —                   |
| 1.56" DIAMETER                         |                                | —                       | —                       | 3081<br>3083          | 3086<br>3082        |
| <b>CORD DIAMETER RANGES</b>            |                                | 0.325-0.655"            | 0.500-0.750"            | 0.325-0.655"          | 0.500-0.750"        |

NOTE: FOR UV RESISTANT BLACK BOXES, ADD SUFFIX "BLK" TO NUMBER.  
 FOR GFCI PROTECTION:  
 ADD "PLG" SUFFIX FOR THE ADDITION OF 15A, 120V, GFCI PLUG.  
 ADD "IN" SUFFIX FOR THE ADDITION OF 15-20A, 120/240V INLINE GFCI.  
 FOR COMPONENT PARTS AND ACCESSORY INFO, SEE PAGE 144.  
 FOR WIRE MESH GRIPS, SEE PAGES 161 & 209.

<sup>1</sup> Primary Cord Length:  
 Use the following chart to specify the length of the primary cord.

3080-10 E 123

| CORD LENGTH |   |
|-------------|---|
| 1' .....    | E |
| 25' .....   | A |
| 50' .....   | B |
| 100' .....  | D |

MOST WOODHEAD PRODUCTS HAVE U.L. AND/OR CSA APPROVALS.  
 FOR A LISTING OF APPROVALS BY PART NUMBER, SEE PAGES 262-269.

## MULTIPLE OUTLET BOXES – 3000 Series

Feed-through boxes are a convenient way to string power to multiple points.



### Super-Safeway® Standard Depth Feed-Thru Outlet Box (3-3/8")

With F2 cord grip. Available with two duplex or two single receptacles

| CONFIGURATION   | TWO DUPLEX OUTLET BOXES |                | TWO SINGLE OUTLET BOXES |                |
|---|-------------------------|----------------|-------------------------|----------------|
|   | STANDARD                | WITH FLIP LIDS | STANDARD                | WITH FLIP LIDS |
| NEMA 5-15  | 3000F-1                 | —              | —                       | —              |
| WITH COVERPLATE ONLY  | 3000F                   | 3005F          | —                       | —              |
| 1.39" DIAMETER  | —                       | —              | 3001F                   | 3006F          |
| 1.56" DIAMETER  | —                       | —              | 3003F                   | 3008F          |
| <b>CORD DIAMETER RANGES</b>   | 0.312-0.625"            | 0.312-0.625"   | 0.312-0.625"            | 0.312-0.625"   |

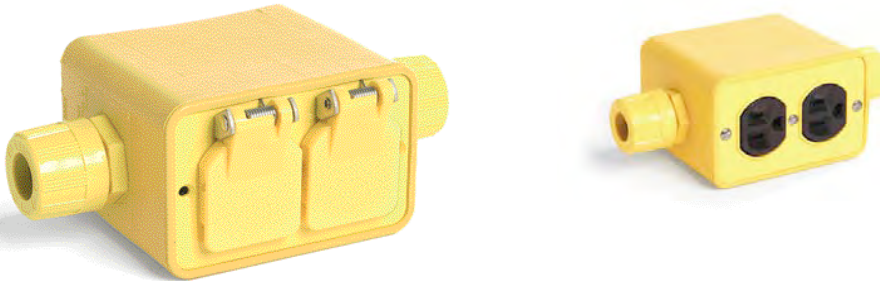

### Super Safeway Extended Depth Feed-Thru Outlet Box (4-3/8")

With F3 cord grip. Available with two duplex or two single receptacles

| CONFIGURATION   | TWO DUPLEX OUTLET BOXES |                | TWO SINGLE OUTLET BOXES |                |
|---|-------------------------|----------------|-------------------------|----------------|
|   | STANDARD                | WITH FLIP LIDS | STANDARD                | WITH FLIP LIDS |
| NEMA 5-15  | 3080F-1                 | —              | —                       | —              |
| WITH COVERPLATE ONLY  | 3080F                   | 3085F          | —                       | —              |
| 1.39" DIAMETER  | —                       | —              | 3081F                   | 3086F          |
| 1.56" DIAMETER  | —                       | —              | 3083F                   | 3088F          |
| <b>CORD DIAMETER RANGES</b>   | 0.500-0.750"            | 0.500-0.750"   | 0.500-0.750"            | 0.500-0.750"   |

NOTE: FOR COMPONENT PARTS AND ACCESSORY INFO, PLEASE SEE PAGE 144.

FOR WIRE MESH GRIPS, SEE PAGES 161 & 209.

FOR UV RESISTANT BLACK, ADD SUFFIX "BLK" TO PART NUMBER.



MOST WOODHEAD PRODUCTS HAVE U.L. AND/OR CSA APPROVALS.  
FOR A LISTING OF APPROVALS BY PART NUMBER, SEE PAGES 262-269.

# PORTABLE OUTLET BOXES

## MULTIPLE OUTLET BOXES – 3000 Series Replacement Parts



### Outlet Boxes

| OUTLET BOX DEPTH | SCREW CLAMP GRIP | ONE MAX-LOC® GRIP | TWO MAX-LOC® GRIPS |
|------------------|------------------|-------------------|--------------------|
| STANDARD 3-3/8"  | 3050             | 3059 (F2)         | 3050F (F2)         |
| EXTENDED 4-3/8"  | 3090             | 3099 (F3)         | 3090F (F3)         |
| EXTENDED 4-3/8"  | —                | 3091 (F4)         | 3091F (F4)         |

### Coverplates for Standard Outlet Boxes



duplex receptacle  
part no. 3051



single receptacle  
1.39" opening  
part no. 3052



single receptacle  
1.56" opening  
part no. 3055



GFCI  
part no. 3060

### Coverplates for Weather-Resistant Outlet Boxes



duplex receptacle  
with flip lids  
part no. 3056



single receptacle  
1.39" opening with flip lids  
part no. 3057



single receptacle  
1.56" opening with flip lids  
part no. 3058



GFCI  
with flip lids  
part no. 3061



blank coverplate  
part no. 3054



GFCI  
clear silicone Watertite®  
part no. 3363





MOST WOODHEAD PRODUCTS HAVE  
U.L. AND/OR CSA APPROVALS.  
FOR A LISTING OF APPROVALS BY  
PART NUMBER, SEE PAGES 262-269.

## MULTIPLE OUTLET BOXES – Pendant Drops

U.L. listed, CSA certified for damp or wet locations. Local protection for worksites where permanent outlets are not available. Two Watertite® single or duplex receptacles are mounted on a durable corrosion-resistant NEOTEX® rubber enclosure with spring-loaded flip lid covers. Meets the requirements of NEMA Type 4X when properly mated with a Woodhead Watertite® plug. MAX-LOC® cord grip (F3), and wire mesh cord grip are standard. Available in 15A and 20A straight-blade or locking configurations.

### Pre-wired Pendant with Two Duplex Receptacles and Flip Lids

| CONFIGURATION  | CORD TYPE | CORD LENGTH | PART NO.  |
|--|-----------|-------------|-----------|
| NEMA 5-15   | 14/3 S00W | 6'          | 70W47L143 |
|  |           | 15'         | 70W47M143 |
|  |           | 25'         | 70W47A143 |
| NEMA L5-15  | 14/3 S00W | 6'          | 75W47L143 |
|  |           | 15'         | 75W47M143 |
|  |           | 25'         | 75W47A143 |
| NEMA 5-20   | 12/3 S00W | 6'          | 70W33L123 |
|  |           | 15'         | 70W33M123 |
|  |           | 25'         | 70W33A123 |

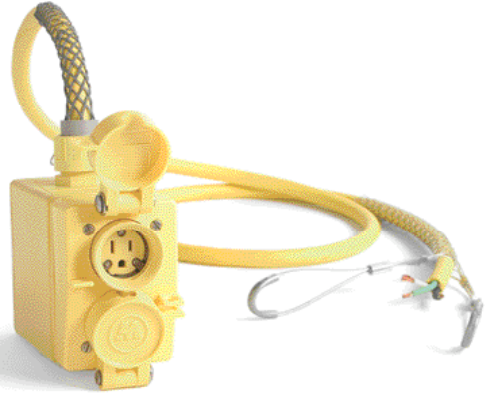

### Pre-wired Pendant with Two Watertite® Single Receptacles and Flip Lids

| CONFIGURATION  | CORD TYPE | CORD LENGTH | PART NO.  |
|--|-----------|-------------|-----------|
| NEMA L5-20  | 12/3 S0W  | 6'          | 77W47L123 |
|  |           | 15'         | 77W47M123 |
|  |           | 25'         | 77W47A123 |

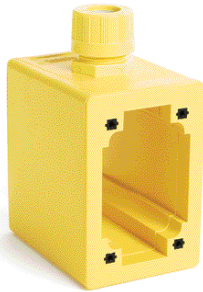

GFCI



duplex



single

### FS/FD Outlet Box

| DESCRIPTION  | STANDARD | FEED-THRU |
|--------------|----------|-----------|
| 4-1/4" DEPTH | 3065     | 3066      |

### Coverplates for FS/FD Outlet Boxes

| DESCRIPTION   | PART NO.  |
|---|-----------|
| CLEAR SILICONE WATERTITE® COVERPLATE WITH 20A/125V GFCI | 3362GF    |
| DUPLEX WATERTITE® COVERPLATE                            | 60W47DPLX |
| SINGLE WATERTITE® COVERPLATE                            | 60W47     |



MOST WOODHEAD PRODUCTS HAVE U.L. AND/OR CSA APPROVALS. FOR A LISTING OF APPROVALS BY PART NUMBER, SEE PAGES 262-269.



## PORTABLE OUTLET BOXES

### MULTIPLE OUTLET BOXES – 3200 Series

Woodhead's Super-Safeway® heavy duty duplex and single receptacle outlet boxes are listed for portable usage and provide the safety and reliability required on today's job sites. Made of durable NEOTEX® rubber to withstand the impact of drops, bumps, and other damage consistent with industrial use, these boxes provide the peace of mind that their exterior will not become energized by loose wire contacts, unlike common metal junction boxes. These boxes accommodate one or two single receptacles or two duplex receptacles per side (receptacles not included).

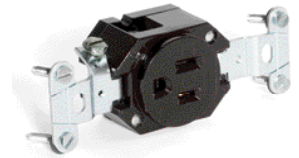
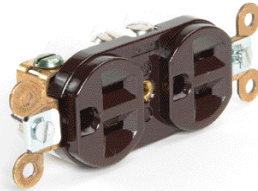

FOR RECEPTACLES SEE WIRING DEVICE SECTION PAGES 48-125.

### Industrial Grade Heavy-Duty Outlet Box

| COVERPLATE ACCEPTS:                | HOLE DIAMETER | BOX  | BOX WITH FLIP LIDS |
|------------------------------------|---------------|------|--------------------|
| (2) DUPLEX RECEPTACLES             | —             | 3210 | 3215               |
| (1) 20A SINGLE LOCKING RECEPTACLE  | 1.562"        | 3220 | 3225               |
| (1) 30A SINGLE LOCKING RECEPTACLE  | 1.718"        | 3230 | 3235               |
| (2) 20A SINGLE LOCKING RECEPTACLES | 1.562"        | 3240 | 3245               |
| (2) 30A SINGLE LOCKING RECEPTACLES | 1.718"        | 3250 | 3255               |
| (2) BLANK COVERPLATES              | —             | 3200 | —                  |

### Watertite® Heavy-Duty Outlet Box

Box with metal-reinforced molded rubber coverplates accommodating two outlets in each plate (four outlets total) in several configurations (receptacles included). Woodhead Watertite® outlets are designed with a soft rubber molded lip to form a weather resistant seal when used with a Watertite® plug. Rubber closure caps seal outlets when not in use.

| CONFIGURATION         | BOX ONLY | BOX WITH 25' 12/3 SOW CORD |
|-----------------------|----------|----------------------------|
| NON-NEMA <sup>1</sup> | 32W07    | —                          |
| NEMA 5-20             | 32W33    | 32W33A123                  |
| NEMA 5-15             | 32W47    | 32W47A123                  |
| NON-NEMA LOCKING      | 35W07    | —                          |
| NEMA L7-15            | 35W34    | —                          |
| NEMA L5-15            | 35W47    | 35W47A123                  |

<sup>1</sup> 3 POLE, 3 WIRE CROWFOOT 10A 250V / 15A 125V\*

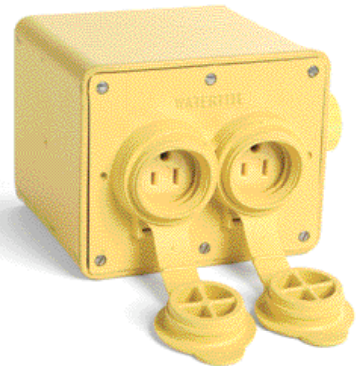

MOST WOODHEAD PRODUCTS HAVE U.L. AND/OR CSA APPROVALS.  
FOR A LISTING OF APPROVALS BY PART NUMBER, SEE PAGES 262-269.

## MULTIPLE OUTLET BOXES – 3200 Series Replacement Parts

### Boxes (F3 Fittings)



part no. 3200



part no. 3300

### Grommets F3

| CORD DIAMETER | COLOR  | PART NO. |
|---------------|--------|----------|
| 0.187-0.250"  | ORANGE | 00-4985  |
| 0.250-0.375"  | GRAY   | 00-4986  |
| 0.375-0.437"  | GREEN  | 00-4987  |
| 0.437-0.562"  | BLACK  | 00-4980  |
| 0.500-0.625"  | GRAY   | 00-4981  |
| 0.562-0.687"  | GREEN  | 00-4982  |
| 0.625-0.750"  | ORANGE | 00-4983  |
| 0.687-0.812"  | YELLOW | 00-4984  |

### Coverplates for Standard Outlet Boxes



part no. 3260



part no. 3261  
1.56" opening



part no. 3262  
1.72" opening



part no. 3263  
1.56" opening



part no. 3264  
1.72" opening



part no. 3265

### Coverplates for Weather-Resistant Outlet Boxes



part no. 3260W



part no. 3261W  
1.56" opening



part no. 3262W  
1.72" opening



part no. 3263W  
1.56" opening



part no. 3264W  
1.72" opening



part no. 3265

### Coverplate for Watertite® Outlet Boxes

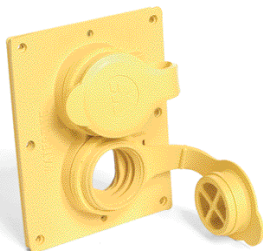

part no. 3266

#### FOR USE WITH

|           |    |            |    |
|-----------|----|------------|----|
| NON-NEMA  | ☺☺ | NON-NEMA   | ☺☺ |
| NEMA 5-15 | ☺☺ | NEMA L7-15 | ☺☺ |
| NEMA 5-20 | ☺☺ | NEMA L5-15 | ☺☺ |



MOST WOODHEAD PRODUCTS HAVE U.L. AND/OR CSA APPROVALS. FOR A LISTING OF APPROVALS BY PART NUMBER, SEE PAGES 262-269.

## PORTABLE OUTLET BOXES

### MULTIPLE OUTLET BOXES – Angled

Factory assembled, pre-wired angled outlet box features a molded NEōTEX® rubber housing and non-metallic cover-plates as well as a rugged Super-Safeway® plug and 12/3 SOW cable. They also are available with weather-resistant spring-loaded flip lid covers. The natural angle design of the box provides arc of bend relief for cords that are powered by this box. The primary plugs for pre-wired boxes match the configuration of the receptacles.

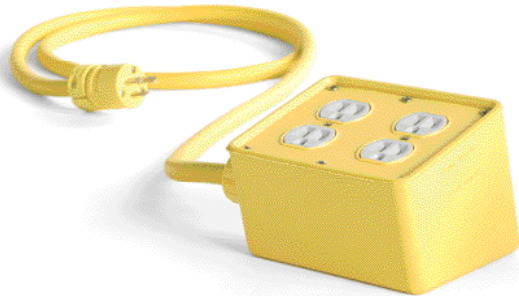

### Angled Outlet Boxes

| CONFIGURATION | RECEPTACLE TYPE | LOCKING BLADE | STANDARD BOX | STANDARD BOX WITH FLIP LIDS AND PLUG | FEED-THRU BOX | FEED-THRU BOX WITH FLIP LIDS AND PLUG |
|---------------|-----------------|---------------|--------------|--------------------------------------|---------------|---------------------------------------|
| NEMA 5-15     | TWO DUPLEX      |               | 3330_123     | 3330R_123                            | 3330F_123     | 3330RF_123                            |
| NEMA L5-15    | TWO DUPLEX      | ●             | 3331_123     | 3331R_123                            | 3331F_123     | 3331RF_123                            |
| NEMA 5-20     | TWO DUPLEX      |               | 3332_123     | 3332R_123                            | 3332F_123     | 3332RF_123                            |
| NEMA L5-20    | TWO SINGLE      | ●             | 3333_123     | 3333R_123                            | 3333F_123     | 3333RF_123                            |

<sup>1</sup> Primary Cord Length: Use the following chart to specify the length of the primary cord.

3330 **E** 123

| CORD LENGTH |   |
|-------------|---|
| 1' .....    | E |
| 6' .....    | L |
| 25' .....   | A |
| 50' .....   | B |

### FACTORY-WIRED 3-PHASE STRINGER SETS

Factory pre-wired portable outlet boxes and cords distribute power safely and easily. Each stringer set contains three 20A 2-pole, 3-wire portable duplex outlet boxes on 10 ft. centers. 30 ft. of 12/5 or 12/4 SOW cable per unit. Weather-resistant NEōTEX® rubber enclosures. Super-Safeway® plugs and MAX-LOC® nylon cord sealing grips. Available in high-visibility yellow or a low profile black.

### Portable Outlet Box Cordsets

| RUBBER BOXES | POLYCARBONATE BOXES | PLUG     | PHASE BOX 1 | PHASE BOX 2 | PHASE BOX 3 | SOW CABLE |
|--------------|---------------------|----------|-------------|-------------|-------------|-----------|
| 3095-000     | 3095-010            | NONE     | A           | B           | C           | 12/5      |
| 3095-001     | 3095-011            | NONE     | A/B         | B/C         | C/A         | 12/5      |
| 3095-002     | 3095-012            | L21-20   | A           | B           | C           | 12/5      |
| 3095-003     | 3095-013            | L21-20   | A/B         | B/C         | C/A         | 12/5      |
| 3095-004     | 3095-014            | NONE     | A/B         | A/B         | A/B         | 12/4      |
| N/A          | 3095-015            | L14-20   | A/B         | A/B         | A/B         | 12/4      |
| N/A          | 3095-016            | NON-NEMA | A           | B           | C           | 12/5      |
| N/A          | 3095-017            | NON-NEMA | A/B         | B/C         | A/C         | 12/5      |

NOTE: FOR BLACK BOXES, ADD "BLK" SUFFIX TO PART NUMBER.



MOST WOODHEAD PRODUCTS HAVE U.L. AND/OR CSA APPROVALS. FOR A LISTING OF APPROVALS BY PART NUMBER, SEE PAGES 262-269.

## FACTORY-WIRED 3-PHASE STRINGER SETS (cntd.)

Wiring Schematics:

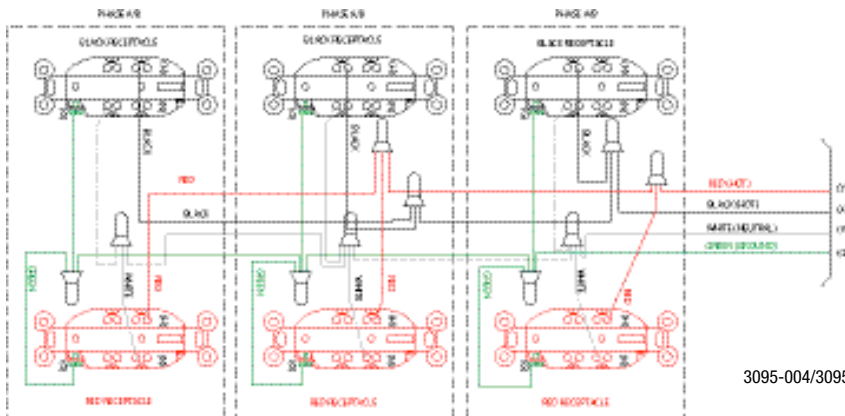
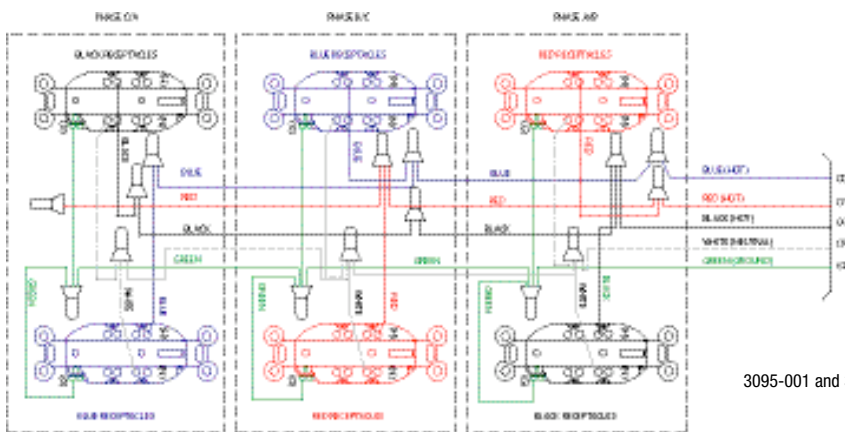
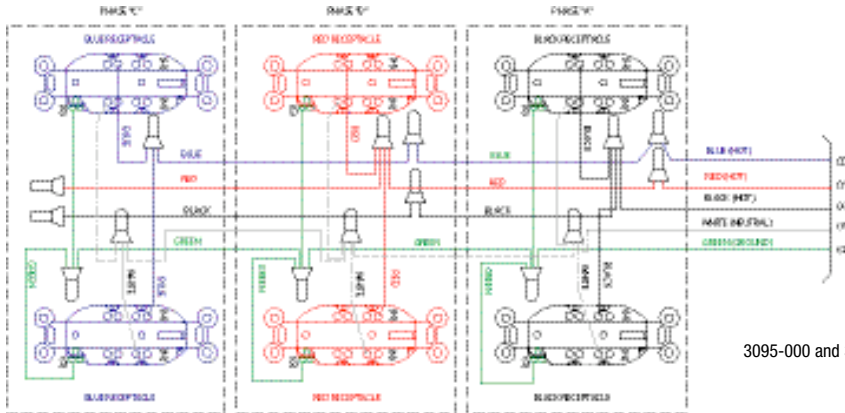

## PORTABLE OUTLET BOXES

### MULTIPLE OUTLET BOXES – Illuminated

Shatterproof Teflon® globe mounted on heavy-duty NEOTEX® rubber box containing four single or four duplex receptacles. Standard duplex receptacles protected by spring-loaded flip lid covers; Watertite® single receptacles protected by rubber closure caps. MAX-LOC® F3 cord grip with mesh grip included. Cord diameter range 0.562-0.687". Meets NFPA 1901 requirements.



### Illuminated Multiple Outlet Box

| NEMA CONFIGURATION            | DUPLIX WITH FLIP LID |             |              | SINGLE WITH FLIP LID |             |              | WATERTITE SINGLE |             |              |
|-------------------------------|----------------------|-------------|--------------|----------------------|-------------|--------------|------------------|-------------|--------------|
|                               | W/O CABLE            | 1' 14/3 SOW | 50' 14/3 SOW | W/O CABLE            | 1' 12/3 SOW | 50' 12/3 SOW | W/O CABLE        | 1' 14/3 SOW | 50' 14/3 SOW |
| 5-15                          | 3290-1               | 3290-1E143  | 3290-1B143   | —                    | —           | —            | 32W90-1          | 32W90-1E143 | 32W90-1B143  |
| L5-15                         | 3290-2               | 3290-2E143  | 3290-2B143   | —                    | —           | —            | 32W90-2          | 32W90-2E143 | 32W90-2B143  |
| NON-NEMA LOCKING <sup>1</sup> | 3290-8               | 3290-8E143  | 3290-8B143   | —                    | —           | —            | 32W90-8          | 32W90-8E143 | 32W90-8B143  |
| L5-20                         | —                    | —           | —            | 3290-3               | 3290-3E123  | 3290-3B123   | —                | —           | —            |
| NON-NEMA LOCKING <sup>2</sup> | —                    | —           | —            | 3290-9               | 3290-9E123  | 3290-9B123   | —                | —           | —            |

<sup>1</sup> 2 Pole, 3 Wire 15A 125V/10A 250V

<sup>2</sup> 2 Pole, 3 Wire 20A 250V



MOST WOODHEAD PRODUCTS HAVE U.L. AND/OR CSA APPROVALS.  
FOR A LISTING OF APPROVALS BY PART NUMBER, SEE PAGES 262-269.

## MULTIPLE OUTLET BOXES – 3400 Series

Black NEOTEX® rubber boxes with unbreakable vinyl coated faceplate. Available with fuses; circuit breakers (NRTL/C); flip lid covers; industrial grade duplex receptacles; MAX-LOC® (F4) cord type grips (1 in. NPT, weather resistant, cord diameter range 0.500-0.875"); Motorbase inputs or outputs; and an assortment of NEMA configurations. Products are suitable for heavy industrial/contractor use, film, T.V. and stage production.



### Standard Box with MAX-LOC® Input Connector

| DESCRIPTION                     | RECEPTACLE CONFIGURATION | MOTORBASE CONFIGURATION | FLIP LID | NO PROTECTION       | WITH BREAKER        | WITH FUSE           |
|---------------------------------|--------------------------|-------------------------|----------|---------------------|---------------------|---------------------|
| (4) DUPLEX RECEPTACLES, 1 PHASE | NEMA 5-15                | NONE                    | ●        | 3400<br>3400L       | 3410<br>3410L       | 3420<br>3420L       |
|                                 | NEMA 5-20                | NONE                    | ●        | 3400-20<br>3400L-20 | 3410-20<br>3410L-20 | 3420-20<br>3420L-20 |
| (3) DUPLEX RECEPTACLES, 3 PHASE | NEMA 5-15                | NONE                    | ●        | 3403<br>3403L       | 3413<br>3413L       | 3423<br>3423L       |
|                                 | NEMA 5-20                | NONE                    | ●        | 3403-20<br>3403L-20 | 3413-20<br>3413L-20 | 3423-20<br>3423L-20 |

### Feed-Thru Box with MAX-LOC® Input Connector & Motorbase Receptacle

| DESCRIPTION                     | RECEPTACLE CONFIGURATION | MOTORBASE CONFIGURATION | FLIP LID | NO PROTECTION         | WITH BREAKER          | WITH FUSE             |
|---------------------------------|--------------------------|-------------------------|----------|-----------------------|-----------------------|-----------------------|
| (3) DUPLEX RECEPTACLES, 1 PHASE | NEMA 5-15                | NEMA 5-15               | ●        | 3400F<br>3400FL       | 3410F<br>3410FL       | 3420F<br>3420FL       |
|                                 | NEMA 5-20                | NEMA 5-20               | ●        | 3400F-20<br>3400FL-20 | 3410F-20<br>3410FL-20 | 3420F-20<br>3420FL-20 |
| (3) DUPLEX RECEPTACLES, 3 PHASE | NEMA 5-20                | NEMA L21-20             | ●        | 3403F-20<br>3403FL-20 | 3413F-20<br>3413FL-20 | 3423F-20<br>3423FL-20 |

### Standard Box with Motor-Base Inlet

| DESCRIPTION                     | RECEPTACLE CONFIGURATION | MOTORBASE CONFIGURATION | FLIP LID | NO PROTECTION         | WITH BREAKER          | WITH FUSE             |
|---------------------------------|--------------------------|-------------------------|----------|-----------------------|-----------------------|-----------------------|
| (3) DUPLEX RECEPTACLES, 1 PHASE | NEMA 5-15                | NEMA 5-15               | ●        | 3400P<br>3400PL       | 3410P<br>3410PL       | 3420P<br>3420PL       |
|                                 | NEMA 5-20                | NEMA 5-20               | ●        | 3400P-20<br>3400PL-20 | 3410P-20<br>3410PL-20 | 3420P-20<br>3420PL-20 |
| (3) DUPLEX RECEPTACLES, 3 PHASE | NEMA 5-20                | NEMA L21-20             | ●        | 3403P-20<br>3403PL-20 | 3413P-20<br>3413PL-20 | 3423P-20<br>3423PL-20 |



MOST WOODHEAD PRODUCTS HAVE U.L. AND/OR CSA APPROVALS.  
FOR A LISTING OF APPROVALS BY PART NUMBER, SEE PAGES 262-269.



## PORTABLE OUTLET BOXES

### MULTIPLE OUTLET BOXES – Multi-Tap® Series

NEōTEX® rubber box with built-in copper buss bars. Molded-in cord grip and polycarbonate outlets. Rubber plug included (plug same as receptacle). Cord diameter range (for box only) 0.325-0.655".

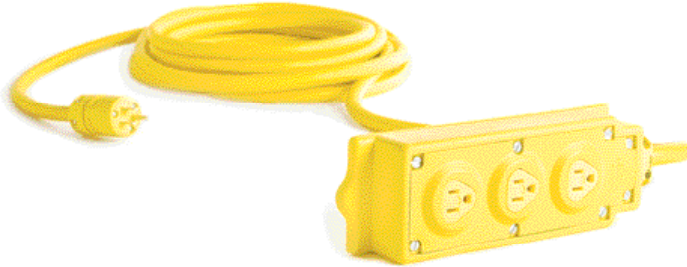

### Multi-Tap Outlet Boxes with Buss Bars

| CONFIGURATION     | BOX WITH 3 OUTLETS<br>EACH RATED: | PRE-WIRED<br>BOX ONLY | 12/3 SOW CORD |           | 14/3 SOW CORD |           |
|-------------------|-----------------------------------|-----------------------|---------------|-----------|---------------|-----------|
|                   |                                   |                       | 25'           | 50'       | 25'           | 50'       |
| NEMA 1-15 (1)(1)  | 2P 2W 15A/125V                    | 31550                 | 31550A122     | 31550B122 | 31550A142     | 31550B142 |
| NON-NEMA (2)(2)   | 3P 3W 15A/125V/10A/250V           | 31552                 | 31552A123     | 31552B123 | 31552A143     | 31552B143 |
| NEMA 5-20 (2)(2)  | 2P 2W 20A/125V                    | 31565 <sup>1</sup>    | 31565A123     | 31565B123 | 31565A143     | 31565B143 |
| NEMA 5-15 (2)(2)  | 2P 3W 15A/125V                    | 31593 <sup>1</sup>    | 31593A123     | 31593B123 | 31593A143     | 31593B143 |
| NEMA 6-15 (2)(2)  | 2P 3W 15A/250V                    | 31594                 | 31594A123     | 31594B123 | 31594A143     | 31594B143 |
| NEMA L5-15 (2)(2) | 2P 3W 15A/125V                    | 32547 <sup>1</sup>    | 32547A123     | 32547B123 | 32547A143     | 32547B143 |
| NON-NEMA (2)(2)   | 3P 3W 15A/125V/10A/250V           | 32553                 | 32553A123     | 32553B123 | 32553A143     | 32553B143 |
| NON-NEMA (2)(2)   | 3P 3W 20A/125V/250V               | 32708                 | 32708A123     | 32708B123 | 32708A143     | 32708B143 |
| NEMA L5-20 (2)(2) | 2P 3W 20A/125V                    | 32747 <sup>1</sup>    | 32747A123     | 32747B123 | 32747A143     | 32747B143 |

<sup>1</sup> TO ORDER WITH A GROUND CONTINUITY MONITOR, ADD "GCM" SUFFIX TO WOODHEAD NUMBER (EX. 31593 GCM)

NOTE: OTHER COMBINATIONS OF CORD AND RECEPTACLES AVAILABLE ON SPECIAL ORDER. CONSULT FACTORY.

FOR GFCI PROTECTION: ADD "PLG" SUFFIX FOR ADDITION OF 15A, 120V GFCI PLUG. ADD "IN" SUFFIX FOR ADDITION OF 15-20 AMP, 120/240V INLINE GFCI.

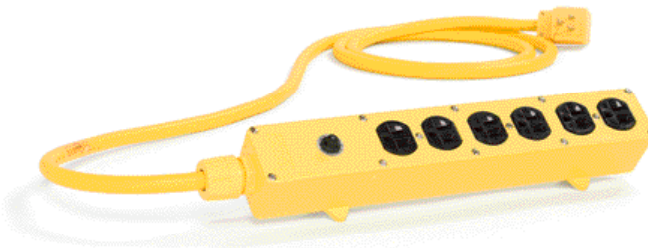

### Multi-Tap Strip and Cordset

U.L. listed. Two-piece nylon box with Woodhead's industrial grade duplex receptacles and MAX-LOC® cord grip (F2). Brass ground buss bar. Two or three 15A straight-blade duplex receptacles with manual reset type circuit breaker. Yellow unit wired with 8 ft. SOOW 14/3 cord with 3-prong, straight-blade, right-angle plug. Black version wired with 8 ft. SY 14 gauge, 3 conductor cord with 3-prong, straight-blade, straight-body plug.

| CONFIGURATION    | 2 DUPLEX RECEPTACLES | 3 DUPLEX RECEPTACLES |
|------------------|----------------------|----------------------|
| NEMA 5-15 (2)(2) | 3500                 | 3510                 |



MOST WOODHEAD PRODUCTS HAVE U.L. AND/OR CSA APPROVALS.  
FOR A LISTING OF APPROVALS BY PART NUMBER, SEE PAGES 262-269.

## MULTIPLE OUTLET BOXES – Miscellaneous

Rigid, self-extinguishing vinyl box with nylon cover-plate, polycarbonate cord clamp and outlets. Two 15 amp 125 volt grounding, NEMA 5-15 receptacles. SPT 300 volt cordset with molded plug.



### Drop Cord

| CONFIGURATION | NO CORD | 25' CORD | 50' CORD |
|---------------|---------|----------|----------|
| NEMA 5-15     | 440     | 442      | 445      |

FOR GFCI PROTECTION: ADD "PLG" SUFFIX FOR THE ADDITION OF A 15A/120V GFCI PLUG.  
ADD "IN" SUFFIX FOR THE ADDITION OF A 15-20A, 120/240V INLINE GFCI.

### Replacement Parts

| DESCRIPTION                              | PART NO. |
|--|----------|
| BOX ONLY                                 | 446      |
| FEEDTHROUGH BOX W/ NEMA 5-15 RECEPTACLES | 440F     |
| FEEDTHROUGH BOX ONLY                     | 446F     |

### Pendant Quad-Tap

Bell-shaped housing of NEōTEX® rubber compounded to retain resilience at sub-zero temperatures. MAX-LOC® (F3) compression grip. Recessed yellow plastic outlets or transparent outlets with neon lamp. Hanging bracket included. Wire mesh grip optional. Cord diameter range 0.437 -0.750". Contains four receptacles in either locking or straight-blade configurations.

| CONFIGURATION | PART NO.           |
|---------------|--------------------|
| NEMA 5-15     | 34047 <sup>1</sup> |
| NEMA L5-15    | 34547              |
| NEMA 5-20     | 34048              |

<sup>1</sup> FOR LIGHTED RECEPTACLES, ADD "L" SUFFIX.  
EXAMPLE: PART NO. 34047L

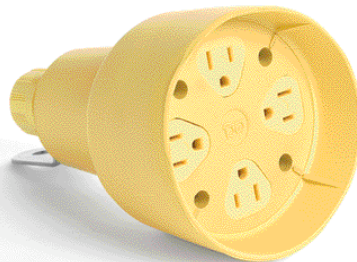

MOST WOODHEAD PRODUCTS HAVE U.L. AND/OR CSA APPROVALS.  
FOR A LISTING OF APPROVALS BY PART NUMBER, SEE PAGES 262-269.





Tough and dependable, Woodhead cable grips and cord grip bodies are reliable workhorses in any plant environment. They serve as flexible holding devices used to pull cable, rope, or tubing into place, and then support the weight of it, once it's installed. They render strain-relief that prevents cable pullout and reduces the arc of bend at points of wire connections or terminations.

Woodhead cable grips and cord grip bodies won't loosen their hold over the long haul. By distributing stress over a large area, they prevent damage to the wire, rope, tubing, or fiber optic cable to which they are applied.

Woodhead offers an incredibly broad line of Wire Mesh Cable Grips and cord grip bodies, including Strain-Relief Grips, Pulling Grips, and Support Grips.

### **Strain-Relief Grips**

Available as a fitting only, or with the addition of wire mesh, they are used to connect cord or cable to electrical enclosures and equipment. Strain-relief grips prevent cable or conduit from pull-out as the result of tension at the point of termination. Wire mesh strain relief grips reduce the arc of bend, which distributes strain over the length of mesh and effectively prolongs cable life.

### **Pulling Grips**

Durable Woodhead pulling grips serve as reusable tools for pulling insulated conductors, bare wires, cable, nylon and wire rope, fiber optic cable, etc., in overhead, underground and in-plant cable pulls.

### **Support Grips**

Available for use indoors and outdoors, support grips distribute the weight of the vertical or sloping runs of electrical and fiber optic cable, metal rods, tubing or hose, over the entire length of the grip so that damage does not occur. A variety of hangers and bales are available. For added corrosion resistance, support grips are available in stainless steel.

## CABLE GRIPS

### STRAIN RELIEF Deluxe Cord Grips

Deluxe cord grips are woven of stainless steel mesh with an aluminum body for corrosion resistance. They are offered in single/double weave construction to help absorb direct pull, to resist flexing and binding, and to eliminate strain. They are recommended for indoor or outdoor use where subjected to moisture in the wiring of pendant stations, processing equipment, hand tools, and extension cord sets. U.L. listed and CSA certified. Deluxe grips are suitable for use in hazardous locations per Class I, Div. 2; Class II, Div. 1 & 2; and Class III, Div. 1 & 2. They are also suitable for use in wet locations so long as the listed gasket is used between box and fitting (see page 160).

Deluxe Cord Grips  
straight male connector

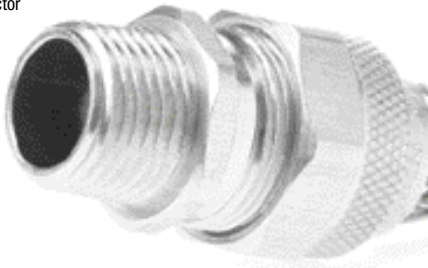

Deluxe Cord Grips  
90° male connector



Deluxe Cord Grips  
45° male connector



Deluxe Cord Grips  
straight female connector



### 3/8" NPT Deluxe Cord Grips

| CABLE DIAMETER RANGE | STRAIGHT MALE PART NO. | 90° MALE PART NO. |
|----------------------|------------------------|-------------------|
| 0.187-0.250"         | 36490                  | 36496             |
| 0.250-0.312"         | 36430                  | 36436             |
| 0.312-0.375"         | 36431                  | 36437             |
| 0.375-0.437"         | 36432                  | 36438             |

### 1/2" NPT Deluxe Cord Grips

| CABLE DIAMETER RANGE | STRAIGHT MALE PART NO. | 90° MALE PART NO. | 45° MALE PART NO. | STRAIGHT FEMALE PART NO. |
|----------------------|------------------------|-------------------|-------------------|--------------------------|
| 0.187-0.250"         | 36250                  | 36340             | 36310             | 36280                    |
| 0.250-0.375"         | 36251                  | 36342             | 36312             | 36282                    |
| 0.375-0.500"         | 36254                  | 36344             | 36314             | 36284                    |
| 0.500-0.625"         | 36256                  | 36346             | 36316             | 36286                    |
| 0.625-0.750"         | 36245                  | —                 | —                 | —                        |
| 0.750-0.875"         | 36246                  | —                 | —                 | —                        |



MOST WOODHEAD PRODUCTS HAVE U.L. AND/OR CSA APPROVALS.  
FOR A LISTING OF APPROVALS BY PART NUMBER, SEE PAGES 262-269.

STRAIN RELIEF Deluxe Cord Grips

3/4" NPT Deluxe Cord Grips

| CABLE DIAMETER RANGE | STRAIGHT MALE PART NO. | 90° MALE PART NO. | 45° MALE PART NO. | STRAIGHT FEMALE PART NO. |
|----------------------|------------------------|-------------------|-------------------|--------------------------|
| 0.250-0.375"         | 36257                  | 36347             | 36317             | 36290                    |
| 0.375-0.500"         | 36259                  | 36349             | 36319             | 36292                    |
| 0.500-0.625"         | 36261                  | 36351             | 36321             | 36294                    |
| 0.625-0.750"         | 36263                  | 36353             | 36323             | 36296                    |
| 0.750-0.875"         | 36248                  | —                 | —                 | —                        |

1" NPT Deluxe Cord Grips

| CABLE DIAMETER RANGE | STRAIGHT MALE PART NO. | 90° MALE PART NO. | 45° MALE PART NO. | STRAIGHT FEMALE PART NO. |
|----------------------|------------------------|-------------------|-------------------|--------------------------|
| 0.437-0.562"         | 36249                  | 36829             | 36826             | 36818                    |
| 0.562-0.687"         | 36275                  | 36830             | 36827             | 36819                    |
| 0.625-0.750"         | 36265                  | 36355             | 36326             | 36298                    |
| 0.750-0.875"         | 36267                  | 36357             | 36328             | 36300                    |
| 0.875-1.000"         | 36269                  | 36359             | 36330             | 36302                    |
| 1.000-1.125"         | 36270                  | —                 | —                 | —                        |
| 1.125-1.250"         | 36276                  | —                 | —                 | —                        |

1-1/4" NPT Deluxe Cord Grips

| CABLE DIAMETER RANGE | STRAIGHT MALE PART NO. | 90° MALE PART NO. |
|----------------------|------------------------|-------------------|
| 0.750-0.875"         | 36277                  | 36831             |
| 0.875-1.000"         | 36271                  | 36361             |
| 1.000-1.125"         | 36272                  | 36362             |
| 1.125-1.250"         | 36273                  | 36363             |
| 1.250-1.375"         | 36274                  | 36364             |

1-1/2" NPT Deluxe Cord Grips

| CABLE DIAMETER RANGE | STRAIGHT MALE PART NO. | 90° MALE PART NO. |
|----------------------|------------------------|-------------------|
| 0.750-0.875"         | 36278                  | 36469             |
| 0.875-1.000"         | 36475                  | 36470             |
| 1.000-1.125"         | 36476                  | 36471             |
| 1.125-1.250"         | 36477                  | 36472             |
| 1.250-1.375"         | 36478                  | 36473             |
| 1.312-1.437"         | 36479                  | —                 |
| 1.437-1.562"         | 36480                  | —                 |
| 1.562-1.687"         | 36481                  | —                 |
| 1.687-1.812"         | 36482                  | —                 |
| 1.750-1.875"         | 36483                  | —                 |

2" NPT Deluxe Cord Grips

| CABLE DIAMETER RANGE | STRAIGHT MALE PART NO. | 90° MALE PART NO. |
|----------------------|------------------------|-------------------|
| 1.250-1.375"         | 36484                  | 36834             |
| 1.312-1.437"         | 36279                  | 36835             |
| 1.437-1.562"         | 36485                  | 36497             |
| 1.562-1.687"         | 36486                  | 36498             |
| 1.687-1.812"         | 36487                  | 36499             |
| 1.750-1.875"         | 36488                  | 36500             |
| 1.812-1.937"         | 36489                  | —                 |
| 1.937-2.062"         | 36816                  | —                 |
| 2.062-2.187"         | 36287                  | —                 |
| 2.187-2.312"         | 36288                  | —                 |
| 2.312-2.437"         | 36289                  | —                 |

3" NPT Deluxe Cord Grips

| CABLE DIAMETER RANGE | STRAIGHT MALE PART NO. |
|----------------------|------------------------|
| 1.688-1.812"         | 36806                  |
| 1.812-1.937"         | 36807                  |
| 1.937-2.062"         | 36808                  |
| 2.062-2.187"         | 36809                  |
| 2.187-2.312"         | 36810                  |
| 2.312-2.437"         | 36811                  |
| 2.437-2.625"         | 36812                  |
| 2.625-2.812"         | 36813                  |
| 2.812-3.000"         | 36814                  |
| 3.000-3.250"         | 36815                  |

2-1/2" NPT Deluxe Cord Grips

| CABLE DIAMETER RANGE | STRAIGHT MALE PART NO. |
|----------------------|------------------------|
| 1.687-1.812"         | 36800                  |
| 1.812-1.937"         | 36801                  |
| 1.937-2.062"         | 36802                  |
| 2.062-2.187"         | 36803                  |
| 2.187-2.312"         | 36804                  |
| 2.312-2.437"         | 36805                  |

 MOST WOODHEAD PRODUCTS HAVE U.L. AND/OR CSA APPROVALS. FOR A LISTING OF APPROVALS BY PART NUMBER, SEE PAGES 262-269.



## CABLE GRIPS

### STRAIN RELIEF MAX-LOC® Cord Sealing Grips – Straight

MAX-LOC cord sealing grips are nylon devices used to connect electrical cables to boxes, cabinets, pushbuttons, enclosures, etc. They are U.L. listed, CSA certified, liquid-tight, highly resistant to impact, and totally corrosion resistant. Non-metallic MAX-LOC cord sealing grips will not support combustion. The ratings are: wire mesh grip – 94HB; fitting – 94V-2. MAX-LOC products are suitable for use in wet locations so long as the listed sealing ring is used between box and fitting. (See page 160.)

MAX-LOC® Cord Sealing Grip  
straight



MAX-LOC Cord Sealing Grip  
straight with O-ring



MAX-LOC Cord Sealing Grip  
straight with stainless steel mesh



MAX-LOC Cord Sealing Grip  
straight with non-metallic mesh

### MAX-LOC Cord-Sealing Grips – 1/4" NPT Straight

| CABLE DIAMETER RANGE | MALE PART NO.     | REPLACEMENT GROMMET | GROMMET COLOR |
|----------------------|-------------------|---------------------|---------------|
| 0.075-0.135"         | 5398 <sup>1</sup> | 00-0920             | BLACK         |
| 0.135-0.200"         | 5400 <sup>1</sup> | 00-0921             | GRAY          |
| 0.200-0.265"         | 5402              | 00-0922             | GREEN         |

### MAX-LOC Cord-Sealing Grips – 3/8" NPT Straight

| CABLE DIAMETER RANGE | MALE PART NO.     | REPLACEMENT GROMMET | GROMMET COLOR |
|----------------------|-------------------|---------------------|---------------|
| 0.062-0.125"         | 5498 <sup>1</sup> | 00-4965             | BLACK         |
| 0.125-0.187"         | 5500              | 00-4960             | YELLOW        |
| 0.187-0.250"         | 5502              | 00-4961             | ORANGE        |
| 0.250-0.312"         | 5504              | 00-4962             | BLACK         |
| 0.312-0.375"         | 5506              | 00-4963             | GRAY          |
| 0.375-0.437"         | 5508 <sup>2</sup> | 00-4964             | GREEN         |

<sup>1</sup> NOT U.L. OR CSA CERTIFIED.

<sup>2</sup> CABLE JACKET MAY NEED TO BE STRIPPED FOR CLEARANCE.



MOST WOODHEAD PRODUCTS HAVE U.L. AND/OR CSA APPROVALS.  
FOR A LISTING OF APPROVALS BY PART NUMBER, SEE PAGES 262-269.

STRAIN RELIEF MAX-LOC® Cord Sealing Grips – Straight

MAX-LOC Cord-Sealing Grips – 1/2" NPT Straight

| CABLE DIAMETER RANGE | MALE PART NO. <sup>1</sup> | MALE W/ O-RING PART NO. | MALE W/ STAINLESS STEEL MESH PART NO. | MALE W/ NON-METALLIC MESH PART NO. | REPLACEMENT GROMMET | GROMMET COLOR |
|----------------------|----------------------------|-------------------------|---------------------------------------|------------------------------------|---------------------|---------------|
| 0.062-0.125"         | 5518 <sup>2</sup>          | 5518W <sup>2</sup>      | —                                     | —                                  | 00-4978             | BLACK         |
| 0.125-0.187"         | 5520                       | 5520W                   | —                                     | —                                  | 00-4970             | YELLOW        |
| 0.187-0.250"         | 5522                       | 5522W                   | 5522M                                 | 5522NM                             | 00-4971             | ORANGE        |
| 0.250-0.312"         | 5524                       | 5524W                   | 5524M                                 | 5524NM                             | 00-4972             | BLACK         |
| 0.312-0.375"         | 5526                       | 5526W                   | 5526M                                 | 5526NM                             | 00-5263             | GRAY          |
| 0.375-0.437"         | 5528                       | 5528W                   | 5528M                                 | 5528NM                             | 00-5264             | GREEN         |
| 0.437-0.500"         | 5530                       | 5530W                   | 5530M                                 | 5530NM                             | 00-4975             | ORANGE        |
| 0.500-0.562"         | 5532 <sup>2</sup>          | 5532W <sup>2</sup>      | 5532M <sup>3</sup>                    | —                                  | 00-5266             | BLACK         |
| 0.562-0.625"         | 5534 <sup>3</sup>          | 5534W <sup>3</sup>      | 5534M <sup>3</sup>                    | —                                  | 00-5267             | GRAY          |

MAX-LOC Cord-Sealing Grips – 3/4" NPT Straight

| CABLE DIAMETER RANGE | MALE PART NO. <sup>1</sup> | MALE W/ O-RING PART NO. | MALE W/ STAINLESS STEEL MESH PART NO. | MALE W/ NON-METALLIC MESH PART NO. | REPLACEMENT GROMMET | GROMMET COLOR |
|----------------------|----------------------------|-------------------------|---------------------------------------|------------------------------------|---------------------|---------------|
| 0.187-0.250"         | 5620                       | 5620W                   | 5620M                                 | 5620NM                             | 00-4985             | ORANGE        |
| 0.250-0.375"         | 5622                       | 5622W                   | 5622M                                 | 5622NM                             | 00-4986             | GRAY          |
| 0.375-0.437"         | 5624                       | 5624W                   | 5624M                                 | 5624NM                             | 00-4987             | GREEN         |
| 0.437-0.562"         | 5536                       | 5536W                   | 5536M                                 | 5536NM                             | 00-4980             | BLACK         |
| 0.500-0.625"         | 5538                       | 5538W                   | 5538M                                 | 5538NM                             | 00-4981             | GRAY          |
| 0.562-0.687"         | 5540                       | 5540W                   | 5540M                                 | 5540NM                             | 00-4982             | GREEN         |
| 0.625-0.750"         | 5542                       | 5542W                   | 5542M                                 | 5542NM                             | 00-4983             | ORANGE        |
| 0.687-0.812"         | 5544 <sup>3</sup>          | 5544W <sup>3</sup>      | 5544M <sup>3</sup>                    | —                                  | 00-4984             | YELLOW        |

MAX-LOC Cord-Sealing Grips – 1" NPT Straight

| CABLE DIAMETER RANGE | MALE PART NO. <sup>1</sup> | MALE W/ O-RING PART NO. | MALE W/ STAINLESS STEEL MESH PART NO. | MALE W/ NON-METALLIC MESH PART NO. | REPLACEMENT GROMMET | GROMMET COLOR |
|----------------------|----------------------------|-------------------------|---------------------------------------|------------------------------------|---------------------|---------------|
| 0.437-0.562"         | 5546                       | 5546W                   | 5546M                                 | 5546NM                             | 00-4990             | BLACK         |
| 0.500-0.625"         | 5548                       | 5548W                   | 5548M                                 | 5548NM                             | 00-4991             | GRAY          |
| 0.562-0.687"         | 5550                       | 5550W                   | 5550M                                 | 5550NM                             | 00-4992             | GREEN         |
| 0.625-0.750"         | 5552                       | 5552W                   | 5552M                                 | 5552NM                             | 00-4993             | ORANGE        |
| 0.687-0.812"         | 5554                       | 5554W                   | 5554M                                 | 5554NM                             | 00-4994             | YELLOW        |
| 0.750-0.875"         | 5556                       | 5556W                   | 5556M                                 | 5556NM                             | 00-4995             | BLACK         |
| 0.812-0.937"         | 5558                       | 5558W                   | 5558M                                 | 5558NM                             | 00-4996             | GRAY          |
| 0.875-1.000"         | 5560                       | 5560W                   | 5560M                                 | 5560NM                             | 00-4997             | GREEN         |
| 1.000-1.100"         | 5562 <sup>2</sup>          | 5562W <sup>2</sup>      | —                                     | —                                  | 00-4998             | BLACK         |

MAX-LOC Cord-Sealing Grips – 1-1/4" NPT Straight

| CABLE DIAMETER RANGE | MALE PART NO. <sup>1</sup> | REPLACEMENT GROMMET | GROMMET COLOR |
|----------------------|----------------------------|---------------------|---------------|
| 0.750-0.875"         | 5568                       | 00-5070             | ORANGE        |
| 0.875-1.000"         | 5570                       | 00-5071             | YELLOW        |
| 1.000-1.125"         | 5572                       | 00-5072             | BLACK         |
| 1.125-1.250"         | 5574                       | 00-5073             | GREEN         |
| 1.250-1.355"         | 5576 <sup>3</sup>          | 00-5074             | GRAY          |

<sup>1</sup> FOR VALOX CONSTRUCTION, ADD "BLK" AS A SUFFIX; FOR EXAMPLE, 5518 BECOMES 5518BLK.

<sup>2</sup> NOT U.L. OR CSA CERTIFIED.

<sup>3</sup> CABLE JACKET MAY NEED TO BE STRIPPED FOR CLEARANCE.



MOST WOODHEAD PRODUCTS HAVE U.L. AND/OR CSA APPROVALS. FOR A LISTING OF APPROVALS BY PART NUMBER, SEE PAGES 262-269.

## CABLE GRIPS

### STRAIN RELIEF MAX-LOC® Cord Sealing Grips – 90°

MAX-LOC cord sealing grips are nylon devices used to connect electrical cables to boxes, cabinets, pushbuttons, enclosures, etc. They are U.L. listed, CSA certified, liquid-tight, highly resistant to impact, and totally corrosion resistant. Non-metallic MAX-LOC cord sealing grips will not support combustion. The ratings are: wire mesh grip – 94HB; fitting – 94V-2. MAX-LOC products are suitable for use in wet locations so long as the listed sealing ring is used between box and fitting. (See page 160.)

MAX-LOC Cord Sealing Grip  
90°



MAX-LOC Cord Sealing Grip  
90° with O-ring



MAX-LOC Cord Sealing Grip  
90° with stainless steel mesh

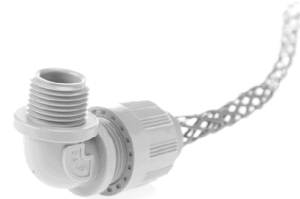

MAX-LOC Cord Sealing Grip  
90° with non-metallic mesh

### MAX-LOC Cord-Sealing Grips – 3/8" NPT 90°

| CABLE DIAMETER RANGE | MALE PART NO.     | REPLACEMENT GROMMET | GROMMET COLOR |
|----------------------|-------------------|---------------------|---------------|
| 0.062-0.125"         | 5499 <sup>1</sup> | 00-4965             | BLACK         |
| 0.125-0.187"         | 5501              | 00-4960             | YELLOW        |
| 0.187-0.250"         | 5503              | 00-4961             | ORANGE        |
| 0.250-0.312"         | 5505              | 00-4962             | BLACK         |
| 0.312-0.375"         | 5507              | 00-4963             | GRAY          |
| 0.375-0.437"         | 5509 <sup>2</sup> | 00-4964             | GREEN         |

<sup>1</sup> NOT U.L. OR CSA CERTIFIED.

<sup>2</sup> CABLE JACKET MAY NEED TO BE STRIPPED FOR CLEARANCE.



MOST WOODHEAD PRODUCTS HAVE U.L. AND/OR CSA APPROVALS.  
FOR A LISTING OF APPROVALS BY PART NUMBER, SEE PAGES 262-269.

STRAIN RELIEF Max-Loc® Cord Sealing Grips – 90°

MAX-LOC Cord-Sealing Grips – 1/2" NPT 90°

| CABLE DIAMETER RANGE | MALE PART NO. <sup>1</sup> | MALE W/ O-RING PART NO. | MALE W/ STAINLESS STEEL MESH PART NO. | MALE W/ NON-METALLIC MESH PART NO. | REPLACEMENT GROMMET | GROMMET COLOR |
|----------------------|----------------------------|-------------------------|---------------------------------------|------------------------------------|---------------------|---------------|
| 0.062-0.125"         | 5519 <sup>2</sup>          | 5519W <sup>2</sup>      | —                                     | —                                  | 00-4978             | BLACK         |
| 0.125-0.187"         | 5521                       | 5521W                   | —                                     | —                                  | 00-4970             | YELLOW        |
| 0.187-0.250"         | 5523                       | 5523W                   | 5523M                                 | 5523NM                             | 00-4971             | ORANGE        |
| 0.250-0.312"         | 5525                       | 5525W                   | 5525M                                 | 5525NM                             | 00-4972             | BLACK         |
| 0.312-0.375"         | 5527                       | 5527W                   | 5527M                                 | 5527NM                             | 00-5263             | GRAY          |
| 0.375-0.437"         | 5529                       | 5529W                   | 5529M                                 | 5529NM                             | 00-5264             | GREEN         |
| 0.437-0.500"         | 5531                       | 5531W                   | 5531M                                 | 5531NM                             | 00-4975             | ORANGE        |
| 0.500-0.562"         | 5533 <sup>3</sup>          | 5533W <sup>3</sup>      | 5533M <sup>3</sup>                    | —                                  | 00-5266             | BLACK         |
| 0.562-0.625"         | 5535 <sup>3</sup>          | 5535W <sup>3</sup>      | 5535M <sup>3</sup>                    | —                                  | 00-5267             | GRAY          |

MAX-LOC Cord-Sealing Grips – 3/4" NPT 90°

| CABLE DIAMETER RANGE | MALE PART NO. <sup>1</sup> | MALE W/ O-RING PART NO. | MALE W/ STAINLESS STEEL MESH PART NO. | MALE W/ NON-METALLIC MESH PART NO. | REPLACEMENT GROMMET | GROMMET COLOR |
|----------------------|----------------------------|-------------------------|---------------------------------------|------------------------------------|---------------------|---------------|
| 0.187-0.250"         | 5621                       | 5621W                   | 5621M                                 | 5621NM                             | 00-4985             | ORANGE        |
| 0.250-0.375"         | 5623                       | 5623W                   | 5623M                                 | 5623NM                             | 00-4986             | GRAY          |
| 0.375-0.437"         | 5625                       | 5625W                   | 5625M                                 | 5625NM                             | 00-4987             | GREEN         |
| 0.437-0.562"         | 5537                       | 5537W                   | 5537M                                 | 5537NM                             | 00-4980             | BLACK         |
| 0.500-0.625"         | 5539                       | 5539W                   | 5539M                                 | 5539NM                             | 00-4981             | GRAY          |
| 0.562-0.687"         | 5541                       | 5541W                   | 5541M                                 | 5541NM                             | 00-4982             | GREEN         |
| 0.625-0.750"         | 5543                       | 5543W                   | 5543M                                 | 5543NM                             | 00-4983             | ORANGE        |
| 0.687-0.812"         | 5545 <sup>3</sup>          | 5545W <sup>3</sup>      | 5545M <sup>3</sup>                    | —                                  | 00-4984             | YELLOW        |

MAX-LOC Cord-Sealing Grips – 1" NPT 90°

| CABLE DIAMETER RANGE | MALE PART NO. <sup>1</sup> | MALE W/ O-RING PART NO. | MALE W/ STAINLESS STEEL MESH PART NO. | MALE W/ NON-METALLIC MESH PART NO. | REPLACEMENT GROMMET | GROMMET COLOR |
|----------------------|----------------------------|-------------------------|---------------------------------------|------------------------------------|---------------------|---------------|
| 0.437-0.562"         | 5547                       | 5547W                   | 5547M                                 | 5547NM                             | 00-4990             | BLACK         |
| 0.500-0.625"         | 5549                       | 5549W                   | 5549M                                 | 5549NM                             | 00-4991             | GRAY          |
| 0.562-0.687"         | 5551                       | 5551W                   | 5551M                                 | 5551NM                             | 00-4992             | GREEN         |
| 0.625-0.750"         | 5553                       | 5553W                   | 5553M                                 | 5553NM                             | 00-4993             | ORANGE        |
| 0.687-0.812"         | 5555                       | 5555W                   | 5555M                                 | 5555NM                             | 00-4994             | YELLOW        |
| 0.750-0.875"         | 5557                       | 5557W                   | 5557M                                 | 5557NM                             | 00-4995             | BLACK         |
| 0.812-0.937"         | 5559                       | 5559W                   | 5559M                                 | 5559NM                             | 00-4996             | GRAY          |
| 0.875-1.000"         | 5561                       | 5561W                   | 5561M                                 | 5561NM                             | 00-4997             | GREEN         |
| 1.000-1.100"         | 5563 <sup>2</sup>          | 5563W <sup>2</sup>      | —                                     | —                                  | 00-4998             | BLACK         |

MAX-LOC Cord-Sealing Grips – 1-1/4" NPT 90°

| CABLE DIAMETER RANGE | MALE PART NO. <sup>1</sup> | REPLACEMENT GROMMET | GROMMET COLOR |
|----------------------|----------------------------|---------------------|---------------|
| 0.750-0.875"         | 5569                       | 00-5070             | ORANGE        |
| 0.875-1.000"         | 5571                       | 00-5071             | YELLOW        |
| 1.000-1.125"         | 5573                       | 00-5072             | BLACK         |
| 1.125-1.250"         | 5575                       | 00-5073             | GREEN         |
| 1.250-1.355"         | 5577 <sup>2</sup>          | 00-5074             | GRAY          |

<sup>1</sup> FOR VALOX CONSTRUCTION, ADD "BLK" AS A SUFFIX; FOR EXAMPLE, 5519 BECOMES 5519BLK.

<sup>2</sup> NOT U.L. OR CSA CERTIFIED.

<sup>3</sup> CABLE JACKET MAY NEED TO BE STRIPPED FOR CLEARANCE.

 MOST WOODHEAD PRODUCTS HAVE U.L. AND/OR CSA APPROVALS. FOR A LISTING OF APPROVALS BY PART NUMBER, SEE PAGES 262-269.

## CABLE GRIPS

### STRAIN RELIEF Specialty

Applications requiring the use of multiple conductors or UF cable can be easily accommodated with the use of Max-Loc® specialty products or accessory grommets.

### MAX-LOC Oval (UF) Cables

| NPT  | CABLE DIAMETER RANGE | STRAIGHT MALE PART NO. | STRAIGHT MALE W/ O-RING PART NO. | 90° MALE PART NO. | REPLACEMENT GROMMETS |
|------|----------------------|------------------------|----------------------------------|-------------------|----------------------|
| 1/2" | 0.218" x 0.421" OVAL | 5580                   | 5580W                            | 5581              | 00-4940              |
| 1/2" | 0.218" x 0.640" OVAL | 5582                   | 5582W                            | 5583              | 00-4941              |
| 3/4" | 0.218" x 0.421" OVAL | 5584                   | —                                | 5585              | 00-4950              |
| 3/4" | 0.218" x 0.640" OVAL | 5586                   | —                                | 5587              | 00-4951              |

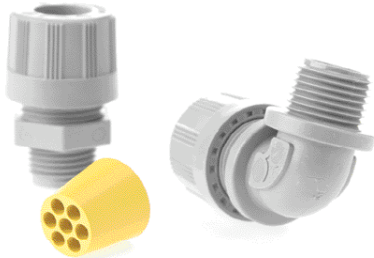

### MAX-LOC 1/2" NPT Multi-Hole

| NPT  | CABLE SIZE | NO. OF HOLES                    | STRAIGHT MALE PART NO. | STRAIGHT MALE W/ O-RING PART NO. | 90° MALE PART NO. | 90° W/ O-RING PART NO. | REPLACEMENT GROMMETS |
|------|------------|---------------------------------|------------------------|----------------------------------|-------------------|------------------------|----------------------|
| 1/2" | 0.156"     | 2, 3 OR 4 <sup>1</sup>          | 5594-007               | 5594-007W                        | 5595-007          | 5595-007W              | 00-1924              |
| 1/2" | 0.187"     | 2, 3, 4, 5, 6 OR 7 <sup>1</sup> | 5594-008               | 5594-008W                        | 5595-008          | 5595-008W              | 00-1925              |
| 1/2" | 0.225"     | 2, 3, OR 4 <sup>1</sup>         | 5594-004               | 5594-004W                        | 5595-004          | 5595-004W              | 00-1921              |
| 1/2" | 0.250"     | 2 OR 3 <sup>1</sup>             | 5594-005               | 5594-005W                        | 5595-005          | 5595-005W              | 00-1922              |
| 1/2" | 0.290"     | 2                               | 5594-006               | 5594-006W                        | 5595-006          | 5595-006W              | 00-1923              |

<sup>1</sup> INDICATES ONE OR MORE HOLES ARE COVERED BY A THIN MEMBRANE WHICH CAN EASILY BE "POKED" OPEN IF REQUIRED.

### Accessories

Expanding the versatility of MAX-LOC for different applications is simple with replacement parts such as gaskets, O-rings, locknuts.



#### Lock nuts



| NPT    | PART NO. |
|--------|----------|
| 1/4"   | 5599     |
| 3/8"   | 5600     |
| 1/2"   | 5601     |
| 3/4"   | 5602     |
| 1"     | 5603     |
| 1-1/4" | 5604     |

#### Gaskets

| NPT    | PART NO. |
|--------|----------|
| 1/4"   | 5609     |
| 3/8"   | 5610     |
| 1/2"   | 5611     |
| 3/4"   | 5612     |
| 1"     | 5613     |
| 1-1/4" | 5614     |

#### O-Rings

| NPT  | PART NO. |
|------|----------|
| 1/2" | 00-0820  |
| 3/4" | 00-0822  |
| 1"   | 00-0824  |

  MOST WOODHEAD PRODUCTS HAVE U.L. AND/OR CSA APPROVALS. FOR A LISTING OF APPROVALS BY PART NUMBER, SEE PAGES 262-269.

## STRAIN RELIEF Grips

### Wide Range, Straight Male, Dust Tight Grips

Wide range grips are recommended for use in wiring of enclosures, power boxes, machine tools, and power centers. Includes insulated bushing.

| NPT    | CABLE DIAMETER RANGE | PART NO. | NON-INSULATED PART NO. |
|--------|----------------------|----------|------------------------|
| 1/2"   | 0.220-0.320"         | 36501    | 36502                  |
| 1/2"   | 0.300-0.430"         | 36503    | 36504                  |
| 1/2"   | 0.400-0.540"         | 36505    | 36506                  |
| 3/4"   | 0.520-0.730"         | 36508    | 36509                  |
| 1"     | 0.700-0.970"         | 36512    | 36513                  |
| 1-1/4" | 0.940-1.250"         | 36515    | 36514                  |
| 1-1/2" | 1.200-1.500"         | 36516    | —                      |
| 2"     | 1.400-1.750"         | 36517    | —                      |
| 2-1/2" | 1.620-2.000"         | 36518    | —                      |
| 2-1/2" | 2.000-2.450"         | 36519    | —                      |



Wide Range, Straight Male, Dust Tight

### Wiring Device I-Grips

Safeway® wire mesh grips provide additional strain-relief for wiring device plugs and connectors used on portable equipment in commercial and institutional applications, and industrial plant and construction site areas, which incur abnormally high abuse.

| CABLE DIAMETER RANGE | MESH LENGTH | PART NO. |
|----------------------|-------------|----------|
| 0.300-0.430"         | 4.75"       | 36550    |
| 0.400-0.560"         | 6.00"       | 36551    |
| 0.520-0.730"         | 7.00"       | 36552    |
| 0.700-0.850"         | 8.50"       | 36553    |
| 0.820-1.000"         | 8.50"       | 36554    |
| 0.940-1.250"         | 10.50"      | 36555    |



MOST WOODHEAD PRODUCTS HAVE U.L. AND/OR CSA APPROVALS. FOR A LISTING OF APPROVALS BY PART NUMBER, SEE PAGES 262-269.

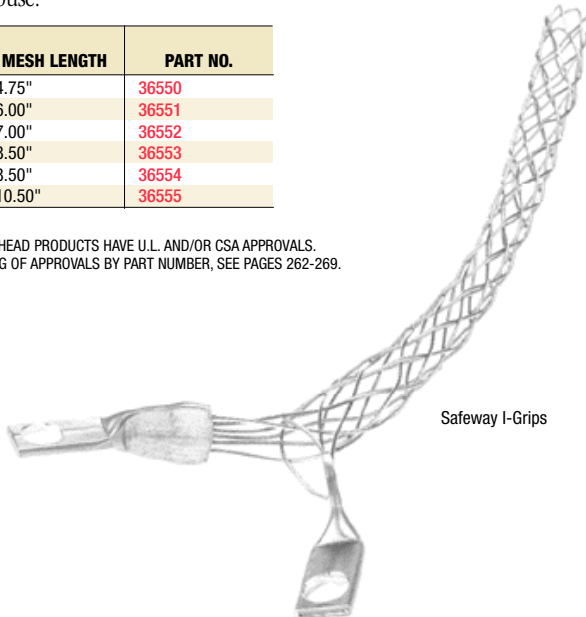

Safeway I-Grips



## CABLE GRIPS

### STRAIN RELIEF Liquid-Tight Grips

Liquid-Tight grips are woven of stainless steel mesh with zinc plated steel or malleable iron bodies and nuts for corrosion resistance. They are used to connect liquid-tight flexible conduit to electrical enclosures to prevent conduit pullout. Each fitting is supplied with an insulated throat to provide conductor insulation and protect against damage by flexing, heat expansion and contraction.

Liquid-Tight grips are recommended in the wiring of motors and any electrical enclosure where liquid-tight conduit is subject to motion or strain. U.L. listed. CSA certified.

Liquid-Tight Grips  
straight male connector



Liquid-Tight Grips  
90° male connector



Liquid-Tight Grips  
45° male connector



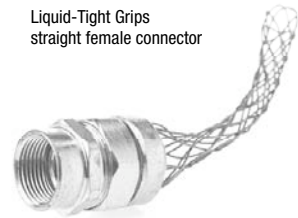

Liquid-Tight Grips  
straight female connector



### Liquid-Tight for Metallic Flexible Conduit

| NPT SIZE | MESH LENGTH | STRAIGHT MALE PART NO. | 90° MALE PART NO. | 45° MALE PART NO. | FEMALE PART NO. |
|----------|-------------|------------------------|-------------------|-------------------|-----------------|
| 3/8"     | 2.625"      | 36440                  | 36443             | 36442             | —               |
| 1/2"     | 3.875"      | 36370                  | 36400             | 36390             | 36380           |
| 3/4"     | 4.375"      | 36371                  | 36401             | 36391             | 36381           |
| 1"       | 5.25"       | 36372                  | 36402             | 36392             | 36382           |
| 1-1/4"   | 5.625"      | 36373                  | 36403             | 36393             | —               |
| 1-1/2"   | 5.75"       | 36374                  | 36404             | 36394             | —               |
| 2"       | 7.5"        | 36375                  | 36405             | 36395             | —               |
| 2-1/2"   | 9.625"      | 37030                  | 37033             | 37036             | —               |
| 3"       | 10.625"     | 37031                  | 37034             | 37037             | —               |
| 4"       | 12"         | 37032                  | 37035             | 37038             | —               |

  MOST WOODHEAD PRODUCTS HAVE U.L. AND/OR CSA APPROVALS.  
FOR A LISTING OF APPROVALS BY PART NUMBER, SEE PAGES 262-269.

## STRAIN RELIEF Liquid-Tight Grips

Liquid-Tight Grips  
90° male connector



Liquid-Tight Grips  
straight male connector

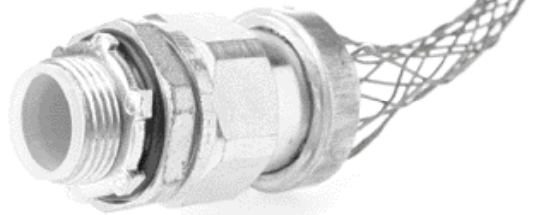

### Liquid-Tight Grips for Non-Metallic Type “A”, Flexible Conduit

| NPT SIZE | MESH LENGTH | STRAIGHT MALE PART NO. | 90° MALE PART NO. |
|----------|-------------|------------------------|-------------------|
| 3/8"     | 9"          | 37100                  | 37100-90          |
| 1/2"     | 10"         | 37101                  | 37101-90          |
| 3/4"     | 10.5"       | 37102                  | 37102-90          |
| 1"       | 12"         | 37103                  | 37103-90          |
| 1-1/4"   | 17"         | 37104                  | 37104-90          |
| 1-1/2"   | 21.5"       | 37105                  | 37105-90          |
| 2"       | 24"         | 37106                  | 37106-90          |



MOST WOODHEAD PRODUCTS HAVE U.L. AND/OR CSA APPROVALS.  
FOR A LISTING OF APPROVALS BY PART NUMBER, SEE PAGES 262-269.

## CABLE GRIPS

### SUPPORT GRIPS Standard Duty, Closed Mesh

Standard closed mesh support grips are designed for loads up to 600 lbs. and vertical runs of no more than 100 ft. They are available in a variety of eye styles and cable ranges for supporting electrical and fiber optic cable, metal rods and tubing. Closed mesh support grips are used when the end of the cable is accessible. Support grips are woven of corrosion-resistant tinned-bronze wire.

#### Standard Duty, Closed Mesh, Single Eye Grips

| CABLE DIAMETER RANGE | PART NO. <sup>1</sup> | BALE LENGTH | MESH LENGTH | APPROXIMATE BREAK STRENGTH <sup>2</sup> |
|----------------------|-----------------------|-------------|-------------|---|
| 0.500-0.610"         | 35030                 | 7"          | 11"         | 770 LBS.                                |
| 0.620-0.740"         | 35031                 | 8"          | 11"         | 960 LBS.                                |
| 0.750-0.990"         | 35032                 | 8"          | 14"         | 1,300 LBS.                              |
| 1.000-1.240"         | 35033                 | 9"          | 15"         | 1,680 LBS.                              |
| 1.250-1.490"         | 35034                 | 10"         | 16"         | 1,680 LBS.                              |
| 1.500-1.740"         | 35035                 | 12"         | 18"         | 1,680 LBS.                              |
| 1.750-1.990"         | 35036                 | 14"         | 20"         | 2,640 LBS.                              |
| 2.000-2.490"         | 35037                 | 16"         | 22"         | 3,760 LBS.                              |
| 2.500-2.990"         | 35038                 | 18"         | 24"         | 3,760 LBS.                              |
| 3.000-3.490"         | 35039                 | 21"         | 26"         | 5,040 LBS.                              |
| 3.500-3.990"         | 35040                 | 24"         | 28"         | 5,040 LBS.                              |

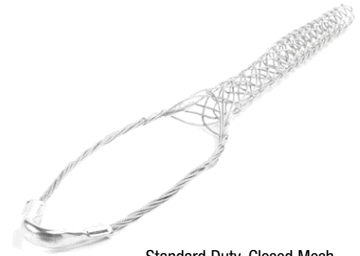

Standard Duty, Closed Mesh, Single Eye Grips

Standard Duty, Closed Mesh, Double Eye Grips

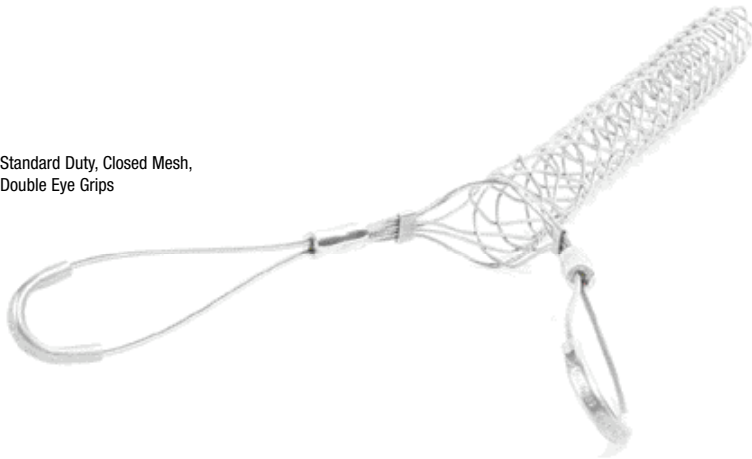

#### Standard Duty, Closed Mesh, Double Eye Grips

| CABLE DIAMETER RANGE | PART NO. <sup>1</sup> | BALE LENGTH | MESH LENGTH | APPROXIMATE BREAK STRENGTH <sup>2</sup> |
|----------------------|-----------------------|-------------|-------------|---|
| 0.500-0.610"         | 35001                 | 4"          | 11"         | 770 LBS.                                |
| 0.620-0.740"         | 35002                 | 4"          | 11"         | 1,150 LBS.                              |
| 0.750-0.990"         | 35003                 | 4"          | 14"         | 1,320 LBS.                              |
| 1.000-1.240"         | 35004                 | 5"          | 15"         | 1,920 LBS.                              |
| 1.250-1.490"         | 35005                 | 5"          | 16"         | 1,920 LBS.                              |
| 1.500-1.740"         | 35006                 | 6"          | 18"         | 1,920 LBS.                              |
| 1.750-1.990"         | 35007                 | 6"          | 20"         | 3,150 LBS.                              |
| 2.000-2.490"         | 35008                 | 6"          | 22"         | 3,360 LBS.                              |
| 2.500-2.990"         | 35009                 | 6"          | 24"         | 3,360 LBS.                              |
| 3.000-3.490"         | 35010                 | 8"          | 26"         | 5,280 LBS.                              |
| 3.500-3.990"         | 35011                 | 8"          | 28"         | 5,280 LBS.                              |

<sup>1</sup> FOR STAINLESS STEEL SUPPORT GRIPS, ADD "SS" SUFFIX TO THE PART NO.; FOR EXAMPLE, 35001 BECOMES 35001SS. CONSULT FACTORY FOR PRICE AND AVAILABILITY.

<sup>2</sup> TO DETERMINE WORKLOAD SAFETY FACTOR, DIVIDE APPROXIMATE BREAK STRENGTH BY 10. SEE PAGE 187 FOR STRENGTH INFORMATION.



MOST WOODHEAD PRODUCTS HAVE U.L. AND/OR CSA APPROVALS. FOR A LISTING OF APPROVALS BY PART NUMBER, SEE PAGES 262-269.

**SUPPORT GRIPS** Standard Duty, Closed Mesh

Standard Duty, Closed Mesh,  
Offset Eye Grips

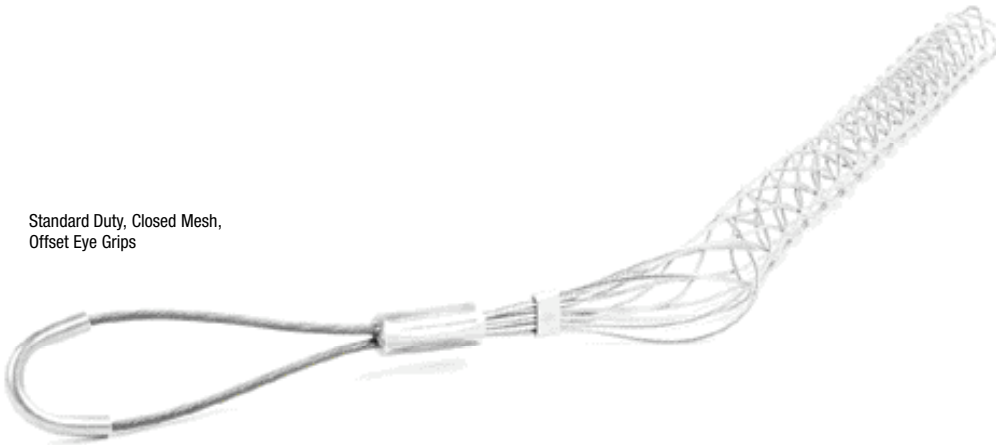

Standard Duty, Closed Mesh, Offset Eye Grips

| CABLE DIAMETER RANGE | PART NO. <sup>1</sup> | BALE LENGTH | MESH LENGTH | APPROXIMATE BREAK STRENGTH <sup>2</sup> |
|----------------------|-----------------------|-------------|-------------|---|
| 0.500-0.610"         | 35060                 | 4"          | 11"         | 770 LBS.                                |
| 0.620-0.740"         | 35061                 | 4"          | 11"         | 960 LBS.                                |
| 0.750-0.990"         | 35062                 | 4"          | 14"         | 960 LBS.                                |
| 1.000-1.240"         | 35063                 | 5"          | 15"         | 1,680 LBS.                              |
| 1.250-1.490"         | 35064                 | 5"          | 16"         | 1,680 LBS.                              |
| 1.500-1.740"         | 35065                 | 5"          | 18"         | 1,680 LBS.                              |
| 1.750-1.990"         | 35066                 | 6"          | 20"         | 2,640 LBS.                              |
| 2.000-2.490"         | 35067                 | 6"          | 22"         | 3,760 LBS.                              |
| 2.500-2.990"         | 35068                 | 8"          | 24"         | 3,760 LBS.                              |
| 3.000-3.490"         | 35069                 | 9"          | 26"         | 5,040 LBS.                              |
| 3.500-3.990"         | 35070                 | 9"          | 28"         | 5,040 LBS.                              |

Standard Duty, Closed Mesh, Locking Bale Grips (Universal Eye)

| CABLE DIAMETER RANGE | PART NO. <sup>1</sup> | BALE LENGTH | MESH LENGTH | APPROXIMATE BREAK STRENGTH <sup>2</sup> |
|----------------------|-----------------------|-------------|-------------|---|
| 0.500-0.610"         | 35090                 | 18"         | 11"         | 770 LBS.                                |
| 0.620-0.740"         | 35091                 | 18"         | 11"         | 1,150 LBS.                              |
| 0.750-0.990"         | 35092                 | 18"         | 14"         | 1,320 LBS.                              |
| 1.000-1.240"         | 35093                 | 18"         | 15"         | 1,920 LBS.                              |
| 1.250-1.490"         | 35094                 | 18"         | 16"         | 1,920 LBS.                              |
| 1.500-1.740"         | 35095                 | 18"         | 18"         | 1,920 LBS.                              |
| 1.750-1.990"         | 35096                 | 18"         | 20"         | 3,150 LBS.                              |
| 2.000-2.490"         | 35097                 | 18"         | 22"         | 3,360 LBS.                              |
| 2.500-2.990"         | 35098                 | 18"         | 24"         | 3,360 LBS.                              |
| 3.000-3.490"         | 35099                 | 18"         | 26"         | 5,280 LBS.                              |
| 3.500-3.990"         | 35100                 | 18"         | 28"         | 5,280 LBS.                              |



Standard Duty, Closed Mesh,  
Locking Bale Grips (Universal Eye)

<sup>1</sup> FOR STAINLESS STEEL SUPPORT GRIPS, ADD "SS" SUFFIX TO THE PART NO.; FOR EXAMPLE, 35001 BECOMES 35001SS. CONSULT FACTORY FOR PRICE AND AVAILABILITY.

<sup>2</sup> TO DETERMINE WORKLOAD SAFETY FACTOR, DIVIDE APPROXIMATE BREAK STRENGTH BY 10. SEE PAGE 187 FOR STRENGTH INFORMATION.



MOST WOODHEAD PRODUCTS HAVE U.L. AND/OR CSA APPROVALS. FOR A LISTING OF APPROVALS BY PART NUMBER, SEE PAGES 262-269.

## CABLE GRIPS

### SUPPORT GRIPS Standard Duty, Split Lace

Split lace support grips are designed for loads up to 600 lbs. and vertical runs of no more than 100 ft. They are available in a variety of eye styles and cable ranges for supporting electrical and fiber optic cable, metal rods and tubing. Split lace support grips are used when the end of the cable cannot easily be accessed and the support grip is intended for permanent installation. Support grips are woven of corrosion-resistant tinned-bronze wire.

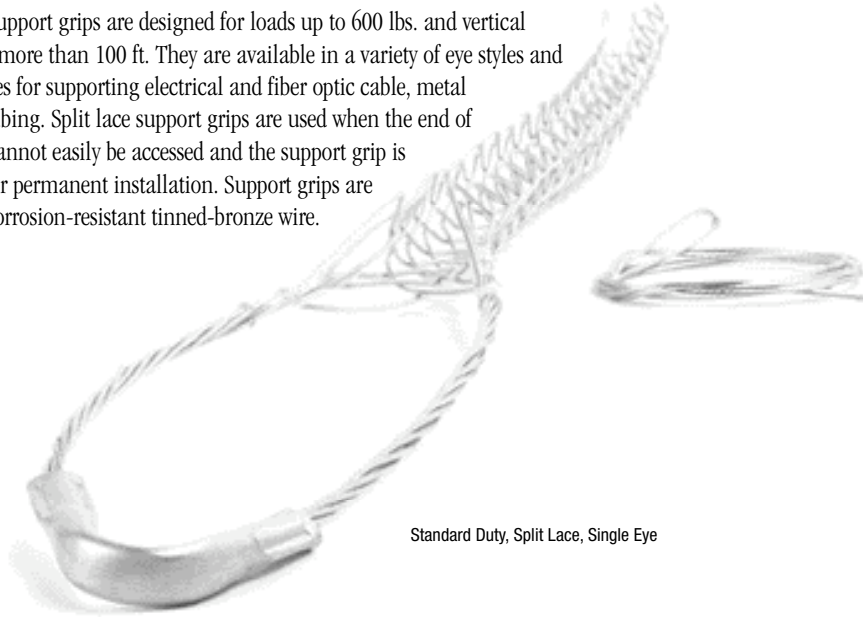

Standard Duty, Split Lace, Single Eye

### Standard Duty, Split Lace, Single Eye

| CABLE DIAMETER RANGE | PART NO. <sup>1</sup> | BALE LENGTH | MESH LENGTH | APPROXIMATE BREAK STRENGTH <sup>2</sup> |
|----------------------|-----------------------|-------------|-------------|---|
| 0.500-0.610"         | 35165                 | 7"          | 11"         | 770 LBS.                                |
| 0.620-0.740"         | 35166                 | 8"          | 11"         | 960 LBS.                                |
| 0.750-0.990"         | 35167                 | 8"          | 14"         | 1,320 LBS.                              |
| 1.000-1.240"         | 35168                 | 9"          | 15"         | 1,680 LBS.                              |
| 1.250-1.490"         | 35169                 | 10"         | 16"         | 1,680 LBS.                              |
| 1.500-1.740"         | 35170                 | 12"         | 18"         | 1,680 LBS.                              |
| 1.750-1.990"         | 35171                 | 14"         | 20"         | 2,640 LBS.                              |
| 2.000-2.490"         | 35172                 | 16"         | 22"         | 3,760 LBS.                              |
| 2.500-2.990"         | 35173                 | 18"         | 24"         | 3,760 LBS.                              |
| 3.000-3.490"         | 35174                 | 21"         | 26"         | 5,040 LBS.                              |
| 3.500-3.990"         | 35175                 | 24"         | 28"         | 5,040 LBS.                              |

### Standard Duty, Split Lace, Double Eye

| CABLE DIAMETER RANGE | PART NO. <sup>1</sup> | BALE LENGTH | MESH LENGTH | APPROXIMATE BREAK STRENGTH <sup>2</sup> |
|----------------------|-----------------------|-------------|-------------|---|
| 0.500-0.610"         | 35135                 | 4"          | 11"         | 770 LBS.                                |
| 0.620-0.740"         | 35136                 | 4"          | 11"         | 1,150 LBS.                              |
| 0.750-0.990"         | 35137                 | 4"          | 14"         | 1,320 LBS.                              |
| 1.000-1.240"         | 35138                 | 5"          | 15"         | 1,920 LBS.                              |
| 1.250-1.490"         | 35139                 | 5"          | 16"         | 1,920 LBS.                              |
| 1.500-1.740"         | 35140                 | 5"          | 18"         | 1,920 LBS.                              |
| 1.750-1.990"         | 35141                 | 6"          | 20"         | 3,150 LBS.                              |
| 2.000-2.490"         | 35142                 | 6"          | 22"         | 3,360 LBS.                              |
| 2.500-2.990"         | 35143                 | 6"          | 24"         | 3,360 LBS.                              |
| 3.000-3.490"         | 35144                 | 8"          | 26"         | 5,280 LBS.                              |
| 3.500-3.990"         | 35145                 | 8"          | 28"         | 5,280 LBS.                              |



Standard Duty, Split Lace, Double Eye

<sup>1</sup> FOR STAINLESS STEEL SUPPORT GRIPS, ADD "SS" SUFFIX TO THE PART NO.; FOR EXAMPLE, 35001 BECOMES 35001SS. CONSULT FACTORY FOR PRICE AND AVAILABILITY.

<sup>2</sup> TO DETERMINE WORKLOAD SAFETY FACTOR, DIVIDE APPROXIMATE BREAK STRENGTH BY 10. SEE PAGE 187 FOR STRENGTH INFORMATION.

 MOST WOODHEAD PRODUCTS HAVE U.L. AND/OR CSA APPROVALS. FOR A LISTING OF APPROVALS BY PART NUMBER, SEE PAGES 262-269.

SUPPORT GRIPS Standard Duty Split Lace

Standard Duty, Split Lace, Offset Eye

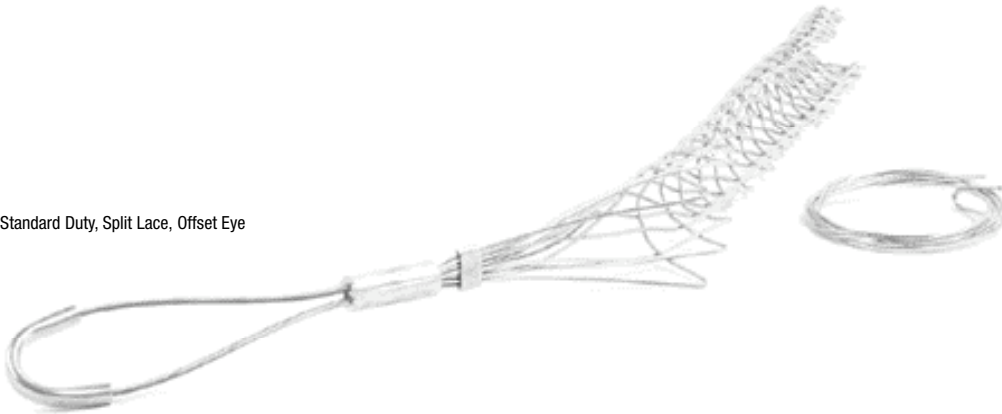

Standard Duty, Split Lace, Offset Eye

| CABLE DIAMETER RANGE | PART NO. <sup>1</sup> | BALE LENGTH | MESH LENGTH | APPROXIMATE BREAK STRENGTH <sup>2</sup> |
|----------------------|-----------------------|-------------|-------------|---|
| 0.500-0.610"         | 35195                 | 4"          | 11"         | 770 LBS.                                |
| 0.620-0.740"         | 35196                 | 4"          | 11"         | 960 LBS.                                |
| 0.750-0.990"         | 35197                 | 4"          | 14"         | 960 LBS.                                |
| 1.000-1.240"         | 35198                 | 5"          | 15"         | 1,680 LBS.                              |
| 1.250-1.490"         | 35199                 | 5"          | 16"         | 1,680 LBS.                              |
| 1.500-1.740"         | 35200                 | 5"          | 18"         | 1,680 LBS.                              |
| 1.750-1.990"         | 35201                 | 8"          | 20"         | 2,640 LBS.                              |
| 2.000-2.490"         | 35202                 | 8"          | 22"         | 3,760 LBS.                              |
| 2.500-2.990"         | 35203                 | 8"          | 24"         | 3,760 LBS.                              |
| 3.000-3.490"         | 35204                 | 9"          | 26"         | 5,040 LBS.                              |
| 3.500-3.990"         | 35205                 | 9"          | 28"         | 5,040 LBS.                              |

Standard Duty, Split Lace, Locking Bale (Universal Eye)

| CABLE DIAMETER RANGE | PART NO. <sup>1</sup> | BALE LENGTH | MESH LENGTH | APPROXIMATE BREAK STRENGTH <sup>2</sup> |
|----------------------|-----------------------|-------------|-------------|---|
| 0.500-0.610"         | 35225                 | 18"         | 11"         | 770 LBS.                                |
| 0.620-0.740"         | 35226                 | 18"         | 11"         | 1,150 LBS.                              |
| 0.750-0.990"         | 35227                 | 18"         | 14"         | 1,320 LBS.                              |
| 1.000-1.240"         | 35228                 | 18"         | 15"         | 1,920 LBS.                              |
| 1.250-1.490"         | 35229                 | 18"         | 16"         | 1,920 LBS.                              |
| 1.500-1.740"         | 35230                 | 18"         | 18"         | 1,920 LBS.                              |
| 1.750-1.990"         | 35231                 | 18"         | 20"         | 3,150 LBS.                              |
| 2.000-2.490"         | 35232                 | 18"         | 22"         | 3,360 LBS.                              |
| 2.500-2.990"         | 35233                 | 18"         | 24"         | 3,360 LBS.                              |
| 3.000-3.490"         | 35234                 | 18"         | 26"         | 5,280 LBS.                              |
| 3.500-3.990"         | 35235                 | 18"         | 28"         | 5,280 LBS.                              |

<sup>1</sup> FOR STAINLESS STEEL SUPPORT GRIPS, ADD "SS" SUFFIX TO THE PART NO.; FOR EXAMPLE, 35001 BECOMES 35001SS. CONSULT FACTORY FOR PRICE AND AVAILABILITY.

<sup>2</sup> TO DETERMINE WORKLOAD SAFETY FACTOR, DIVIDE APPROXIMATE BREAK STRENGTH BY 10. SEE PAGE 187 FOR STRENGTH INFORMATION.

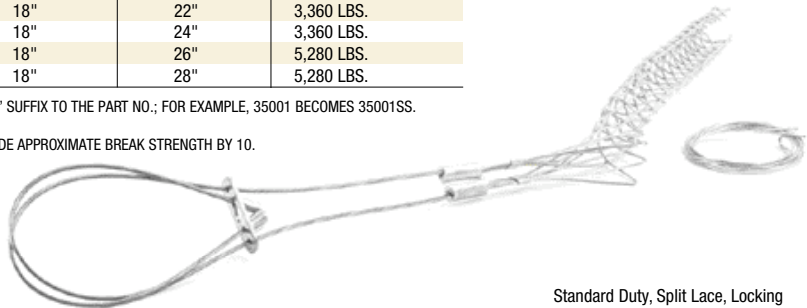

Standard Duty, Split Lace, Locking Bale (Universal Eye)

UL SR MOST WOODHEAD PRODUCTS HAVE U.L. AND/OR CSA APPROVALS. FOR A LISTING OF APPROVALS BY PART NUMBER, SEE PAGES 262-269.



## CABLE GRIPS

### SUPPORT GRIPS Standard Duty, Split Rod

Split rod support grips are designed for loads up to 600 lbs. and vertical runs of no more than 100 ft. They are available in a variety of eye styles and cable ranges for supporting electrical and fiber optic cable, metal rods and tubing. Split rod support grips are used when the end of the cable cannot be easily accessed and the installation is temporary. Support grips are woven of corrosion-resistant tinned-bronze wire.

#### Standard Duty, Split Rod, Single Eye

| CABLE DIAMETER RANGE | PART NO. <sup>1</sup> | BALE LENGTH | MESH LENGTH | APPROXIMATE BREAK STRENGTH <sup>2</sup> |
|----------------------|-----------------------|-------------|-------------|---|
| 0.500-0.610"         | 35285                 | 7"          | 11"         | 770 LBS.                                |
| 0.620-0.740"         | 35286                 | 8"          | 11"         | 960 LBS.                                |
| 0.750-0.990"         | 35287                 | 8"          | 14"         | 1,320 LBS.                              |
| 1.000-1.240"         | 35288                 | 9"          | 15"         | 1,680 LBS.                              |
| 1.250-1.490"         | 35289                 | 10"         | 16"         | 1,680 LBS.                              |
| 1.500-1.740"         | 35290                 | 12"         | 18"         | 1,680 LBS.                              |
| 1.750-1.990"         | 35291                 | 14"         | 20"         | 2,640 LBS.                              |
| 2.000-2.490"         | 35292                 | 16"         | 22"         | 3,760 LBS.                              |
| 2.500-2.990"         | 35293                 | 18"         | 24"         | 3,760 LBS.                              |
| 3.000-3.490"         | 35294                 | 21"         | 26"         | 6,560 LBS.                              |
| 3.500-3.990"         | 35295                 | 24"         | 28"         | 6,560 LBS.                              |

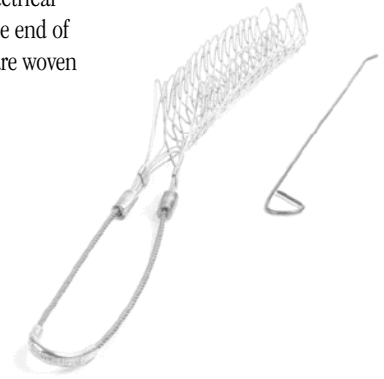

Standard Duty, Split Rod, Single Eye

Standard Duty, Split Rod, Double Eye

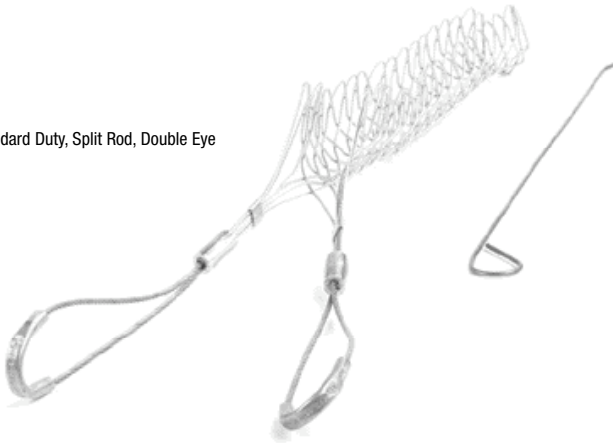

#### Standard Duty, Split Rod, Double Eye

| CABLE DIAMETER RANGE | PART NO. <sup>1</sup> | BALE LENGTH | MESH LENGTH | APPROXIMATE BREAK STRENGTH <sup>2</sup> |
|----------------------|-----------------------|-------------|-------------|---|
| 0.500-0.610"         | 35270                 | 4"          | 11"         | 770 LBS.                                |
| 0.620-0.740"         | 35271                 | 4"          | 11"         | 1,150 LBS.                              |
| 0.750-0.990"         | 35272                 | 4"          | 14"         | 1,320 LBS.                              |
| 1.000-1.240"         | 35273                 | 5"          | 15"         | 1,920 LBS.                              |
| 1.250-1.490"         | 35274                 | 5"          | 16"         | 1,920 LBS.                              |
| 1.500-1.740"         | 35275                 | 5"          | 18"         | 1,920 LBS.                              |
| 1.750-1.990"         | 35276                 | 6"          | 20"         | 3,150 LBS.                              |
| 2.000-2.490"         | 35277                 | 6"          | 22"         | 3,360 LBS.                              |
| 2.500-2.990"         | 35278                 | 6"          | 24"         | 3,360 LBS.                              |
| 3.000-3.490"         | 35279                 | 8"          | 26"         | 7,520 LBS.                              |
| 3.500-3.990"         | 35280                 | 8"          | 28"         | 7,520 LBS.                              |

<sup>1</sup> FOR STAINLESS STEEL SUPPORT GRIPS, ADD "SS" SUFFIX TO THE PART NO.; FOR EXAMPLE, 35001 BECOMES 35001SS. CONSULT FACTORY FOR PRICE AND AVAILABILITY.

<sup>2</sup> TO DETERMINE WORKLOAD SAFETY FACTOR, DIVIDE APPROXIMATE BREAK STRENGTH BY 10. SEE PAGE 187 FOR STRENGTH INFORMATION.



MOST WOODHEAD PRODUCTS HAVE U.L. AND/OR CSA APPROVALS. FOR A LISTING OF APPROVALS BY PART NUMBER, SEE PAGES 262-269.

SUPPORT GRIPS Standard Duty Split Rod

Standard Duty, Split Rod, Offset Eye

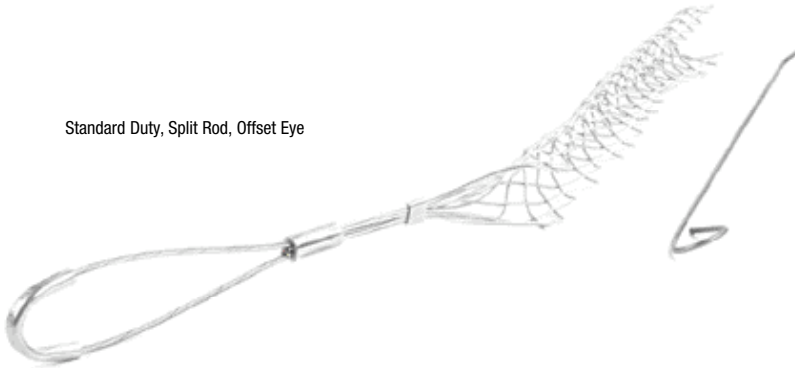

Standard Duty, Split Rod, Offset Eye

| CABLE DIAMETER RANGE | PART NO. <sup>1</sup> | BALE LENGTH | MESH LENGTH | APPROXIMATE BREAK STRENGTH <sup>2</sup> |
|----------------------|-----------------------|-------------|-------------|---|
| 0.500-0.610"         | 35300                 | 4"          | 11"         | 770 LBS.                                |
| 0.620-0.740"         | 35301                 | 4"          | 11"         | 960 LBS.                                |
| 0.750-0.990"         | 35302                 | 4"          | 14"         | 960 LBS.                                |
| 1.000-1.240"         | 35303                 | 5"          | 15"         | 1,680 LBS.                              |
| 1.250-1.490"         | 35304                 | 5"          | 16"         | 1,680 LBS.                              |
| 1.500-1.740"         | 35305                 | 5"          | 18"         | 1,680 LBS.                              |
| 1.750-1.990"         | 35306                 | 6"          | 20"         | 2,640 LBS.                              |
| 2.000-2.490"         | 35307                 | 6"          | 22"         | 3,760 LBS.                              |
| 2.500-2.990"         | 35308                 | 6"          | 24"         | 3,760 LBS.                              |
| 3.000-3.490"         | 35309                 | 8"          | 26"         | 5,040 LBS.                              |
| 3.500-3.990"         | 35310                 | 8"          | 28"         | 5,040 LBS.                              |

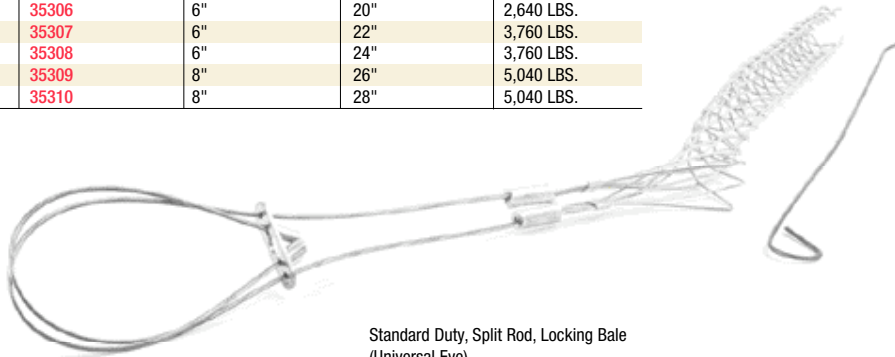

Standard Duty, Split Rod, Locking Bale (Universal Eye)

Standard Duty, Split Rod, Locking Bale (Universal Eye)

| CABLE DIAMETER RANGE | PART NO. <sup>1</sup> | BALE LENGTH | MESH LENGTH | APPROXIMATE BREAK STRENGTH <sup>2</sup> |
|----------------------|-----------------------|-------------|-------------|---|
| 0.500-0.610"         | 35330                 | 10"         | 9"          | 770 LBS.                                |
| 0.620-0.740"         | 35331                 | 10"         | 9"          | 1,150 LBS.                              |
| 0.750-0.990"         | 35332                 | 10"         | 11"         | 1,320 LBS.                              |
| 1.000-1.240"         | 35333                 | 14"         | 13"         | 1,920 LBS.                              |
| 1.250-1.490"         | 35334                 | 14"         | 15"         | 1,920 LBS.                              |
| 1.500-1.740"         | 35335                 | 14"         | 16"         | 1,920 LBS.                              |
| 1.750-1.990"         | 35336                 | 14"         | 17"         | 3,150 LBS.                              |
| 2.000-2.490"         | 35337                 | 18"         | 20"         | 3,360 LBS.                              |
| 2.500-2.990"         | 35338                 | 18"         | 22"         | 3,360 LBS.                              |
| 3.000-3.490"         | 35339                 | 18"         | 24"         | 5,280 LBS.                              |
| 3.500-3.990"         | 35340                 | 18"         | 26"         | 5,280 LBS.                              |

<sup>1</sup> FOR STAINLESS STEEL SUPPORT GRIPS, ADD "SS" SUFFIX TO THE PART NO.; FOR EXAMPLE, 35001 BECOMES 35001SS. CONSULT FACTORY FOR PRICE AND AVAILABILITY.

<sup>2</sup> TO DETERMINE WORKLOAD SAFETY FACTOR, DIVIDE APPROXIMATE BREAK STRENGTH BY 10. SEE PAGE 187 FOR STRENGTH INFORMATION.



MOST WOODHEAD PRODUCTS HAVE U.L. AND/OR CSA APPROVALS. FOR A LISTING OF APPROVALS BY PART NUMBER, SEE PAGES 262-269.

# CABLE GRIPS

## SUPPORT GRIPS Heavy Duty

Heavy duty support grips feature a double weave mesh and are available in a variety of eye styles and cable ranges for supporting electrical and fiber optic cable, metal rods and tubing. Support grips are woven of corrosion-resistant tinned-bronze wire.

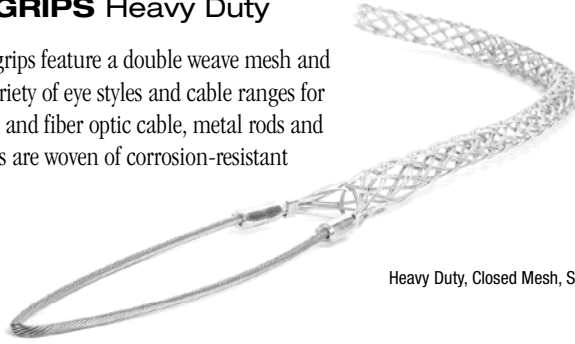

Heavy Duty, Closed Mesh, Single Eye

### Heavy Duty, Closed Mesh, Single Eye

| CABLE DIAMETER RANGE | PART NO. <sup>1</sup> | BALE LENGTH | MESH LENGTH | APPROXIMATE BREAK STRENGTH <sup>2</sup> |
|----------------------|-----------------------|-------------|-------------|---|
| 0.750-0.990"         | 35435                 | 10"         | 26"         | 2,700 LBS.                              |
| 1.000-1.240"         | 35436                 | 10"         | 29"         | 4,720 LBS.                              |
| 1.250-1.490"         | 35437                 | 10"         | 31"         | 4,720 LBS.                              |
| 1.500-1.990"         | 35438                 | 10"         | 35"         | 4,720 LBS.                              |

### Heavy Duty, Closed Mesh, Double Eye

| CABLE DIAMETER RANGE | PART NO. <sup>1</sup> | BALE LENGTH | MESH LENGTH | APPROXIMATE BREAK STRENGTH <sup>2</sup> |
|----------------------|-----------------------|-------------|-------------|---|
| 0.750-0.990"         | 35425                 | 10"         | 26"         | 2,700 LBS.                              |
| 1.000-1.240"         | 35426                 | 10"         | 29"         | 4,720 LBS.                              |
| 1.250-1.490"         | 35427                 | 10"         | 31"         | 4,720 LBS.                              |
| 1.500-1.990"         | 35428                 | 10"         | 35"         | 4,720 LBS.                              |
| 2.000-2.490"         | 35429                 | 10"         | 37"         | 10,080 LBS.                             |
| 2.500-2.990"         | 35430                 | 10"         | 39"         | 10,080 LBS.                             |
| 3.000-3.490"         | 35431                 | 10"         | 41"         | 10,080 LBS.                             |
| 3.500-3.990"         | 35432                 | 10"         | 45"         | 13,120 LBS.                             |
| 4.000-4.490"         | 35433                 | 10"         | 47"         | 13,120 LBS.                             |



Heavy Duty, Closed Mesh, Double Eye

### Heavy Duty, Split Lace, Single Eye

| CABLE DIAMETER RANGE | PART NO. <sup>1</sup> | BALE LENGTH | MESH LENGTH | APPROXIMATE BREAK STRENGTH <sup>2</sup> |
|----------------------|-----------------------|-------------|-------------|---|
| 0.750-0.990"         | 35450                 | 10"         | 26"         | 2,700 LBS.                              |
| 1.000-1.240"         | 35451                 | 10"         | 29"         | 4,720 LBS.                              |
| 1.250-1.490"         | 35452                 | 10"         | 31"         | 4,720 LBS.                              |
| 1.500-1.990"         | 35453                 | 10"         | 35"         | 4,720 LBS.                              |



Heavy Duty, Split Lace, Single Eye

### Heavy Duty, Split Lace, Double Eye

| CABLE DIAMETER RANGE | PART NO. <sup>1</sup> | BALE LENGTH | MESH LENGTH | APPROXIMATE BREAK STRENGTH <sup>2</sup> |
|----------------------|-----------------------|-------------|-------------|---|
| 0.750-0.990"         | 35440                 | 10"         | 26"         | 2,700 LBS.                              |
| 1.000-1.240"         | 35441                 | 10"         | 29"         | 4,720 LBS.                              |
| 1.250-1.490"         | 35442                 | 10"         | 31"         | 4,720 LBS.                              |
| 1.500-1.990"         | 35443                 | 10"         | 35"         | 4,720 LBS.                              |
| 2.000-2.490"         | 35444                 | 10"         | 37"         | 10,080 LBS.                             |
| 2.500-2.990"         | 35445                 | 10"         | 39"         | 10,080 LBS.                             |
| 3.000-3.490"         | 35446                 | 10"         | 41"         | 10,080 LBS.                             |
| 3.500-3.990"         | 35447                 | 10"         | 45"         | 13,120 LBS.                             |
| 4.000-4.490"         | 35448                 | 10"         | 47"         | 13,120 LBS.                             |



Heavy Duty, Split Lace, Double Eye

<sup>1</sup> FOR STAINLESS STEEL SUPPORT GRIPS, ADD "SS" SUFFIX TO THE PART NO.; FOR EXAMPLE, 35001 BECOMES 35001SS. CONSULT FACTORY FOR PRICE AND AVAILABILITY.

<sup>2</sup> TO DETERMINE WORKLOAD SAFETY FACTOR, DIVIDE APPROXIMATE BREAK STRENGTH BY 10. SEE PAGE 187 FOR STRENGTH INFORMATION.



MOST WOODHEAD PRODUCTS HAVE U.L. AND/OR CSA APPROVALS. FOR A LISTING OF APPROVALS BY PART NUMBER, SEE PAGES 262-269.

## SUPPORT GRIPS Service Drop

Service drop grips provide support for utility distribution lines from service pole to building or from pole to pole. They can also be used for cable TV and fiber optic cable support. They are woven from tinned bronze wire to provide superior corrosion resistance, and are available in single eye and locking bale configurations.

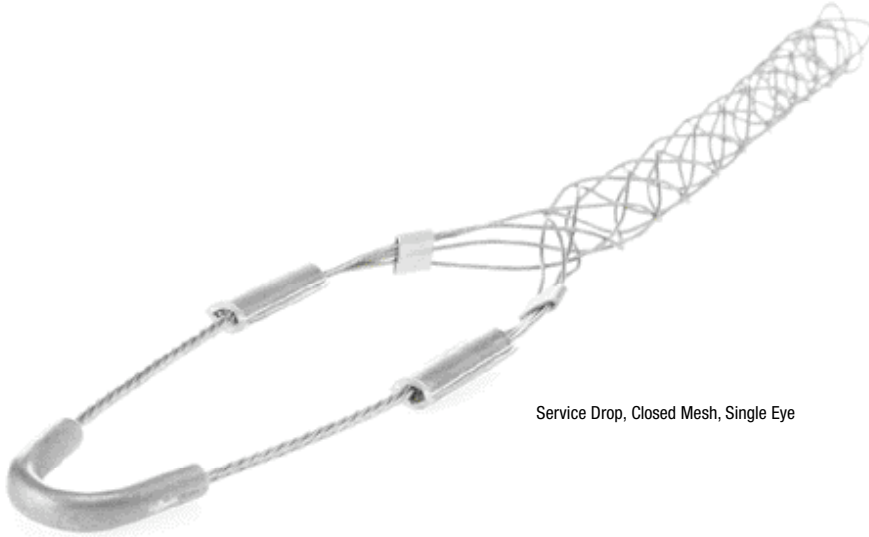

Service Drop, Closed Mesh, Single Eye

### Service Drop, Closed Mesh, Single Eye

| CABLE DIAMETER RANGE | PART NO. | BALE LENGTH | MESH LENGTH | APPROXIMATE BREAK STRENGTH <sup>1</sup> |
|----------------------|----------|-------------|-------------|---|
| 0.220-0.320"         | 36573    | 4"          | 4"          | 290 LBS.                                |
| 0.300-0.430"         | 36575    | 5"          | 5"          | 500 LBS.                                |
| 0.410-0.560"         | 36576    | 6"          | 5"          | 500 LBS.                                |
| 0.530-0.730"         | 36577    | 8"          | 8"          | 790 LBS.                                |
| 0.700-0.970"         | 36578    | 8"          | 9"          | 1,020 LBS.                              |
| 0.940-1.250"         | 36579    | 10"         | 11"         | 1,020 LBS.                              |

### Service Drop, Closed Mesh, Locking Bale

| CABLE DIAMETER RANGE | PART NO. | BALE LENGTH | MESH LENGTH | APPROXIMATE BREAK STRENGTH <sup>1</sup> |
|----------------------|----------|-------------|-------------|---|
| 0.220-0.320"         | 36581    | 10"         | 4"          | 290 LBS.                                |
| 0.300-0.430"         | 36583    | 11"         | 5"          | 500 LBS.                                |
| 0.410-0.560"         | 36585    | 12"         | 5"          | 500 LBS.                                |
| 0.530-0.730"         | 36586    | 14"         | 8"          | 790 LBS.                                |
| 0.700-0.970"         | 36588    | 14"         | 9"          | 1,020 LBS.                              |
| 0.940-1.250"         | 36590    | 16"         | 11"         | 1,020 LBS.                              |



Service Drop, Closed Mesh, Locking Bale

<sup>1</sup> TO DETERMINE WORKLOAD SAFETY FACTOR, DIVIDE APPROXIMATE BREAK STRENGTH BY 10. SEE PAGE 187 FOR STRENGTH INFORMATION.



MOST WOODHEAD PRODUCTS HAVE U.L. AND/OR CSA APPROVALS. FOR A LISTING OF APPROVALS BY PART NUMBER, SEE PAGES 262-269.

## CABLE GRIPS

### SUPPORT GRIPS Bus Drop

Bus drop grips are used as cable support. They relieve any direct tension from the critical connection and absorb vibration and flexing. Bus drop grips are woven of galvanized steel wire. They are offered with either the single eye or locking bale attachment.

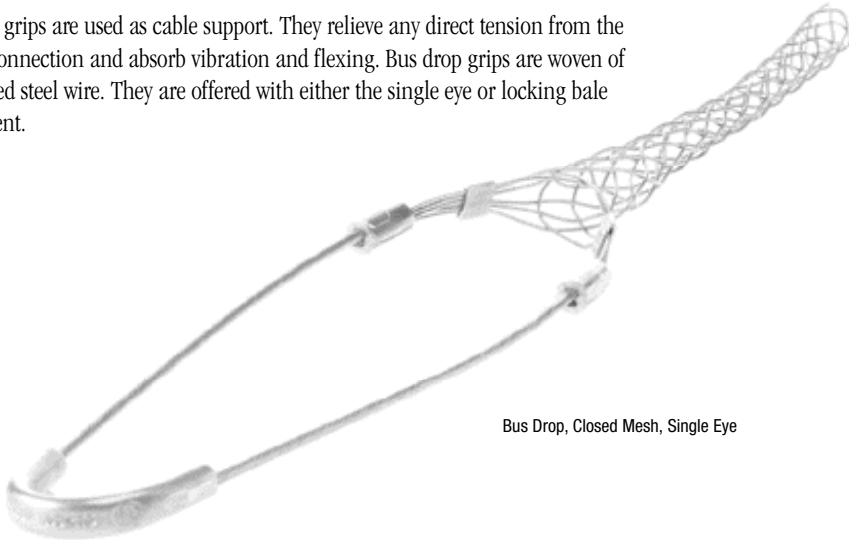

Bus Drop, Closed Mesh, Single Eye

### Bus Drop, Closed Mesh, Single Eye

| CABLE DIAMETER RANGE | PART NO. | BALE LENGTH | MESH LENGTH | APPROXIMATE BREAK STRENGTH <sup>1</sup> |
|----------------------|----------|-------------|-------------|---|
| 0.220-0.320"         | 36560    | 9"          | 3.5"        | 1,100 LBS.                              |
| 0.300-0.430"         | 36562    | 9"          | 4.5"        | 1,100 LBS.                              |
| 0.410-0.560"         | 36564    | 9"          | 5.0"        | 1,100 LBS.                              |
| 0.530-0.730"         | 36567    | 9"          | 6.5"        | 1,100 LBS.                              |
| 0.700-0.850"         | 36569    | 9"          | 8.5"        | 1,900 LBS.                              |
| 0.820-1.000"         | 36571    | 9"          | 8.5"        | 1,900 LBS.                              |
| 0.960-1.250"         | 36574    | 9"          | 11.0"       | 1,900 LBS.                              |

### Bus Drop, Closed Mesh, Locking Bale

| CABLE DIAMETER RANGE | PART NO. | BALE LENGTH | MESH LENGTH | APPROXIMATE BREAK STRENGTH <sup>1</sup> |
|----------------------|----------|-------------|-------------|---|
| 0.220-0.320"         | 36580    | 12"         | 3.5"        | 1,100 LBS.                              |
| 0.300-0.430"         | 36582    | 12"         | 4.5"        | 1,100 LBS.                              |
| 0.410-0.560"         | 36584    | 12"         | 5.0"        | 1,100 LBS.                              |
| 0.530-0.730"         | 36587    | 15"         | 6.5"        | 1,100 LBS.                              |
| 0.700-0.850"         | 36589    | 16"         | 8.5"        | 1,900 LBS.                              |
| 0.820-1.000"         | 36591    | 16"         | 8.5"        | 1,900 LBS.                              |
| 0.960-1.250"         | 36594    | 17"         | 11.0"       | 1,900 LBS.                              |



Bus Drop, Closed Mesh, Locking Bale

<sup>1</sup> TO DETERMINE WORKLOAD SAFETY FACTOR, DIVIDE APPROXIMATE BREAK STRENGTH BY 10. SEE PAGE 187 FOR STRENGTH INFORMATION.

### Bus Drop Accessories

| DESCRIPTION                | PART NO. |
|----------------------------|----------|
| SAFETY SPRING, 40 LB. LOAD | 36237    |
| SAFETY SPRING, 80 LB. LOAD | 36238    |
| SUPPORT HOOK               | 36241    |



Accessories

 MOST WOODHEAD PRODUCTS HAVE U.L. AND/OR CSA APPROVALS. FOR A LISTING OF APPROVALS BY PART NUMBER, SEE PAGES 262-269.

## SUPPORT GRIPS Fiber Optic

Fiber optic support grips are designed to reduce stress on fragile cables in vertical or sloping runs. They are woven of nonmagnetic tinned bronze wire, and are available in both single eye and locking bale configurations. A split rod version is offered for use on existing runs of cable or where specific placement of the grip along the cable is desired.

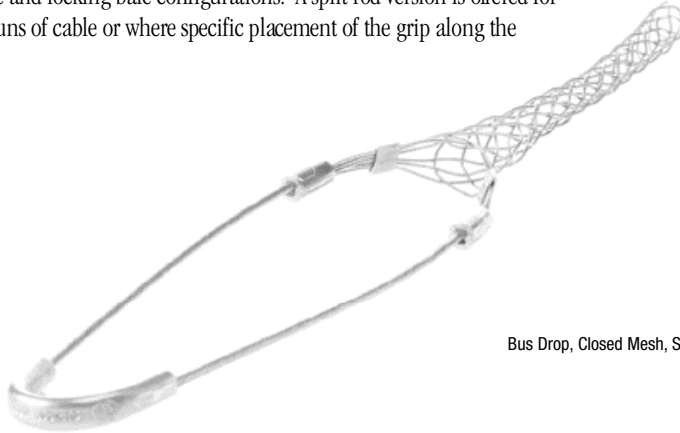

Bus Drop, Closed Mesh, Single Eye

### Fiber Optic, Closed Mesh, Single Eye

| CABLE DIAMETER RANGE | PART NO. | BALE LENGTH | MESH LENGTH | APPROXIMATE BREAK STRENGTH <sup>1</sup> |
|----------------------|----------|-------------|-------------|---|
| 0.180-0.250"         | 36670    | 3"          | 1.7"        | 300 LBS.                                |
| 0.230-0.320"         | 36671    | 3"          | 2.5"        | 300 LBS.                                |
| 0.300-0.390"         | 36672    | 4"          | 2.5"        | 300 LBS.                                |
| 0.370-0.480"         | 36673    | 5"          | 4.0"        | 300 LBS.                                |
| 0.460-0.580"         | 36674    | 6"          | 4.0"        | 400 LBS.                                |
| 0.560-0.710"         | 36675    | 7"          | 5.5"        | 600 LBS.                                |
| 0.690-0.880"         | 36676    | 8"          | 6.0"        | 800 LBS.                                |

### Fiber Optic, Closed Mesh, Locking Bale

| CABLE DIAMETER RANGE | PART NO. | BALE LENGTH | MESH LENGTH | APPROXIMATE BREAK STRENGTH <sup>1</sup> |
|----------------------|----------|-------------|-------------|---|
| 0.180-0.250"         | 36690    | 9"          | 2.5"        | 300 LBS.                                |
| 0.230-0.320"         | 36691    | 9"          | 2.0"        | 300 LBS.                                |
| 0.300-0.390"         | 36692    | 9"          | 2.5"        | 300 LBS.                                |
| 0.370-0.480"         | 36693    | 10"         | 4.0"        | 300 LBS.                                |
| 0.460-0.580"         | 36694    | 10"         | 4.0"        | 400 LBS.                                |
| 0.560-0.710"         | 36695    | 10"         | 5.5"        | 600 LBS.                                |
| 0.690-0.880"         | 36696    | 10"         | 6.0"        | 800 LBS.                                |



Fiber Optic, Closed Mesh, Locking Bale

### Fiber Optic, Split Rod, Single Eye

| CABLE DIAMETER RANGE | PART NO. | BALE LENGTH | MESH LENGTH | APPROXIMATE BREAK STRENGTH <sup>1</sup> |
|----------------------|----------|-------------|-------------|---|
| 0.180-0.250"         | 36680    | 3"          | 2.5"        | 300 LBS.                                |
| 0.230-0.320"         | 36681    | 3"          | 2.5"        | 300 LBS.                                |
| 0.300-0.390"         | 36682    | 4"          | 2.5"        | 300 LBS.                                |
| 0.370-0.480"         | 36683    | 5"          | 4.0"        | 300 LBS.                                |
| 0.460-0.580"         | 36684    | 6"          | 5.0"        | 400 LBS.                                |
| 0.560-0.710"         | 36685    | 7"          | 5.0"        | 600 LBS.                                |
| 0.690-0.880"         | 36686    | 8"          | 6.0"        | 800 LBS.                                |



Fiber Optic, Split Rod, Single Eye

<sup>1</sup> TO DETERMINE WORKLOAD SAFETY FACTOR, DIVIDE APPROXIMATE BREAK STRENGTH BY 10. SEE PAGE 187 FOR STRENGTH INFORMATION.



MOST WOODHEAD PRODUCTS HAVE U.L. AND/OR CSA APPROVALS. FOR A LISTING OF APPROVALS BY PART NUMBER, SEE PAGES 262-269.



## CABLE GRIPS

### PULLING GRIPS Junior Duty

Junior duty series grips are indispensable tools for electricians with small job requirements. They are used to connect insulated wire bundles to pulling tape or to pull wire or rope through conduit.

Junior Duty, Flexible Eye



### Junior Duty, Flexible Eye

| CABLE DIAMETER RANGE | PART NO. | DESCRIPTION | MESH LENGTH | APPROXIMATE BREAK STRENGTH <sup>1</sup> |
|----------------------|----------|-------------|-------------|---|
| 0.250-0.360"         | 35970    | PJ25        | 5"          | 1,700 LBS.                              |
| 0.370-0.490"         | 35971    | PJ37        | 7"          | 1,700 LBS.                              |
| 0.500-0.610"         | 35972    | PJ50        | 8"          | 1,700 LBS.                              |
| 0.620-0.740"         | 35973    | PJ62        | 10"         | 2,800 LBS.                              |
| 0.750-0.990"         | 35974    | PJ75        | 10"         | 4,100 LBS.                              |
| 1.000-1.240"         | 35975    | PJ100       | 12"         | 4,100 LBS.                              |

<sup>1</sup> TO DETERMINE WORKLOAD SAFETY FACTOR, DIVIDE APPROXIMATE BREAK STRENGTH BY 5. SEE PAGE 187 FOR STRENGTH INFORMATION.

### Junior Duty, Flexible Eye Kit

| DESCRIPTION                       | PART NO. |
|-----------------------------------|----------|
| KIT: CONTAINS 1 EACH OF THE ABOVE | 35976    |



MOST WOODHEAD PRODUCTS HAVE U.L. AND/OR CSA APPROVALS. FOR A LISTING OF APPROVALS BY PART NUMBER, SEE PAGES 262-269.

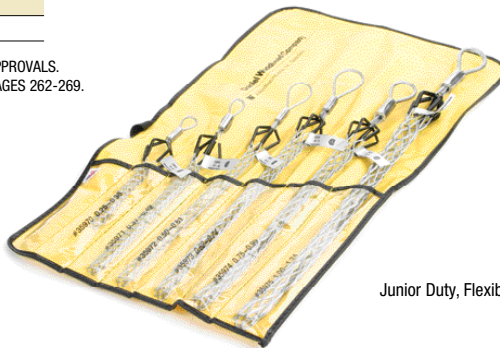

Junior Duty, Flexible Eye

## PULLING GRIPS Light Duty

Light duty grips are the most economical pulling grips for many applications, such as industrial plant wiring, and rewiring, and underground electrical pulls.

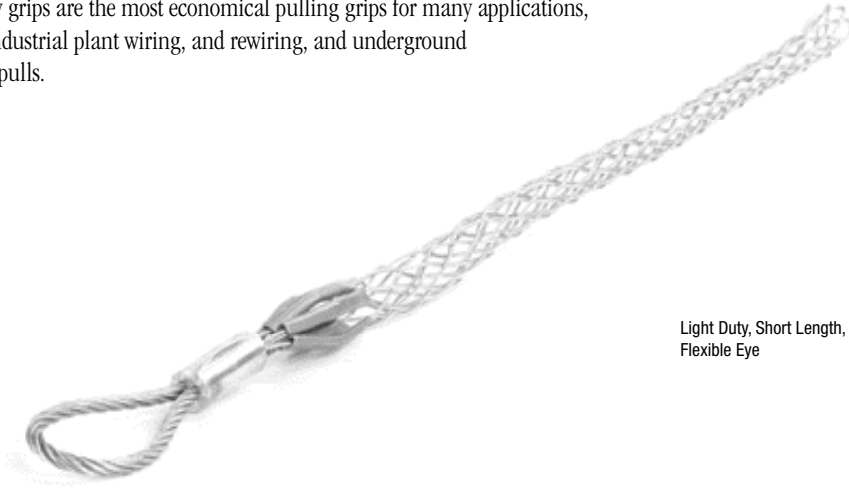

Light Duty, Short Length, Flexible Eye

### Light Duty, Short Length, Flexible Eye

| CABLE DIAMETER RANGE | PART NO. | MESH LENGTH | APPROXIMATE BREAK STRENGTH <sup>1</sup> |
|----------------------|----------|-------------|---|
| 0.500-0.610"         | 35901    | 11"         | 3,400 LBS.                              |
| 0.620-0.740"         | 35902    | 11"         | 4,100 LBS.                              |
| 0.750-0.990"         | 35903    | 13"         | 4,100 LBS.                              |
| 1.000-1.240"         | 35904    | 14"         | 5,800 LBS.                              |
| 1.250-1.490"         | 35905    | 15"         | 5,800 LBS.                              |
| 1.500-1.740"         | 35906    | 16"         | 7,500 LBS.                              |
| 1.750-1.990"         | 35907    | 18"         | 10,000 LBS.                             |
| 2.000-2.490"         | 35908    | 19"         | 10,000 LBS.                             |
| 2.500-2.990"         | 35909    | 19"         | 13,000 LBS.                             |

### Light Duty, Standard Length, Flexible Eye

| CABLE DIAMETER RANGE | PART NO. | MESH LENGTH | APPROXIMATE BREAK STRENGTH <sup>1</sup> |
|----------------------|----------|-------------|---|
| 0.500-0.610"         | 35910    | 16"         | 3,400 LBS.                              |
| 0.620-0.740"         | 35911    | 16"         | 4,100 LBS.                              |
| 0.750-0.990"         | 35912    | 20"         | 4,100 LBS.                              |
| 1.000-1.240"         | 35913    | 20"         | 7,500 LBS.                              |
| 1.250-1.490"         | 35914    | 22"         | 7,500 LBS.                              |
| 1.500-1.990"         | 35915    | 25"         | 7,500 LBS.                              |
| 2.000-2.490"         | 35916    | 26"         | 10,000 LBS.                             |
| 2.500-2.990"         | 35917    | 28"         | 13,000 LBS.                             |
| 3.000-3.490"         | 35918    | 30"         | 16,200 LBS.                             |
| 3.500-3.990"         | 35919    | 32"         | 19,400 LBS.                             |

### Light Duty, Standard Length, Flexible Eye Kit

| DESCRIPTION  | PART NO. |
|--|----------|
| KIT: CONTAINS 1 EACH OF 35912, 35913, 35915, 35916 | 35990    |

<sup>1</sup> TO DETERMINE WORKLOAD SAFETY FACTOR, DIVIDE APPROXIMATE BREAK STRENGTH BY 5. SEE PAGE 187 FOR STRENGTH INFORMATION.



MOST WOODHEAD PRODUCTS HAVE U.L. AND/OR CSA APPROVALS. FOR A LISTING OF APPROVALS BY PART NUMBER, SEE PAGES 262-269.

## CABLE GRIPS

### PULLING GRIPS Medium Duty

Medium duty pulling grips are ideal for overhead and underground pulling applications that require additional durability at an economical price. Medium duty pulling grips are hand crafted with single weave strands that graduate to a double weave design for added strength and durability.



Medium Duty, Flexible Eye

#### Medium Duty, Flexible Eye

| CABLE DIAMETER RANGE | PART NO. | MESH LENGTH | APPROXIMATE BREAK STRENGTH <sup>1</sup> |
|----------------------|----------|-------------|---|
| 0.370-0.490"         | 35930    | 13"         | 2,600 LBS.                              |
| 0.500-0.740"         | 35931    | 17"         | 3,400 LBS.                              |
| 0.750-0.990"         | 35932    | 20"         | 5,500 LBS.                              |
| 1.000-1.240"         | 35933    | 28"         | 8,100 LBS.                              |
| 1.250-1.490"         | 35934    | 33"         | 8,100 LBS.                              |
| 1.500-1.740"         | 35935    | 36"         | 8,100 LBS.                              |

<sup>1</sup> TO DETERMINE WORKLOAD SAFETY FACTOR, DIVIDE APPROXIMATE BREAK STRENGTH BY 5. SEE PAGE 187 FOR STRENGTH INFORMATION.

#### Medium Duty, Flexible Eye Kit

| DESCRIPTION                       | PART NO. |
|-----------------------------------|----------|
| KIT: CONTAINS 1 EACH OF THE ABOVE | 35936    |

  MOST WOODHEAD PRODUCTS HAVE U.L. AND/OR CSA APPROVALS. FOR A LISTING OF APPROVALS BY PART NUMBER, SEE PAGES 262-269.

**PULLING GRIPS Medium Duty**

Medium duty pulling grips are recommended for heavy or rugged applications, and are ideally suited for overhead and underground installations. These grips are woven in galvanized steel.

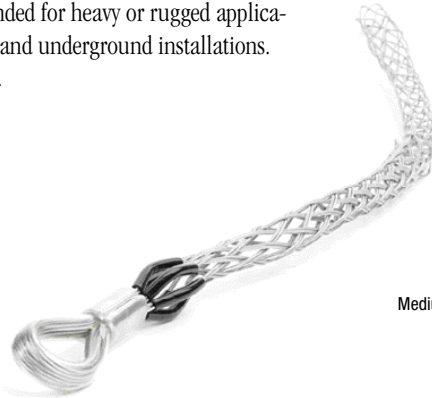

Medium Duty, Short Length, Flexible Eye, T-Type

**Medium Duty, Short Length, Flexible Eye, T-Type**

| CABLE DIAMETER RANGE | PART NO. | MESH LENGTH | EYE DIAMETER | APPROXIMATE BREAK STRENGTH <sup>1</sup> |
|----------------------|----------|-------------|--------------|---|
| 0.500-0.610"         | 35940    | 21"         | 7/32"        | 4,500 LBS.                              |
| 0.620-0.740"         | 35941    | 24"         | 1/4"         | 5,600 LBS.                              |
| 0.750-0.990"         | 35942    | 24"         | 1/4"         | 6,800 LBS.                              |
| 1.000-1.490"         | 35943    | 24"         | 5/16"        | 9,600 LBS.                              |
| 1.500-1.990"         | 35944    | 24"         | 7/16"        | 16,400 LBS.                             |
| 2.000-2.490"         | 35945    | 24"         | 7/16"        | 18,500 LBS.                             |
| 2.500-2.990"         | 35946    | 24"         | 1/2"         | 24,500 LBS.                             |
| 3.000-3.490"         | 35947    | 24"         | 1/2"         | 24,500 LBS.                             |
| 3.500-3.990"         | 35948    | 26"         | 5/8"         | 31,000 LBS.                             |

**Medium Duty, Standard Length, Flexible Eye, T-Type**

| CABLE DIAMETER RANGE | PART NO. | MESH LENGTH | EYE DIAMETER | APPROXIMATE BREAK STRENGTH <sup>1</sup> |
|----------------------|----------|-------------|--------------|---|
| 0.750-0.990"         | 35950    | 36"         | 1/4"         | 6,800 LBS.                              |
| 1.000-1.490"         | 35951    | 36"         | 5/16"        | 9,600 LBS.                              |
| 1.500-1.990"         | 35952    | 36"         | 7/16"        | 16,400 LBS.                             |
| 2.000-2.490"         | 35953    | 36"         | 7/16"        | 18,500 LBS.                             |
| 2.500-2.990"         | 35954    | 36"         | 1/2"         | 24,500 LBS.                             |
| 3.000-3.490"         | 35955    | 36"         | 1/2"         | 24,500 LBS.                             |
| 3.500-3.990"         | 35956    | 40"         | 5/8"         | 31,000 LBS.                             |

**Medium Duty, Standard Length, Flexible Eye Kit**

| DESCRIPTION   | PART NO. |
|---|----------|
| KIT: T-TYPE CONTAINS 1 EACH OF 35950, 35951, 35952, 35953 | 35980    |

**Medium Duty, Long Length, Flexible Eye**

| CABLE DIAMETER RANGE | PART NO. | MESH LENGTH | APPROXIMATE BREAK STRENGTH <sup>1</sup> |
|----------------------|----------|-------------|---|
| 0.750-0.990"         | 35960    | 48"         | 8,100 LBS.                              |
| 1.000-1.490"         | 35961    | 48"         | 11,600 LBS.                             |
| 1.500-1.990"         | 35962    | 48"         | 19,400 LBS.                             |
| 2.000-2.490"         | 35963    | 48"         | 19,400 LBS.                             |
| 2.500-2.990"         | 35964    | 48"         | 25,900 LBS.                             |
| 3.000-3.490"         | 35965    | 48"         | 25,900 LBS.                             |
| 3.500-3.990"         | 35966    | 48"         | 32,400 LBS.                             |

<sup>1</sup> TO DETERMINE WORKLOAD SAFETY FACTOR, DIVIDE APPROXIMATE BREAK STRENGTH BY 5. SEE PAGE 187 FOR STRENGTH INFORMATION.

 MOST WOODHEAD PRODUCTS HAVE U.L. AND/OR CSA APPROVALS. FOR A LISTING OF APPROVALS BY PART NUMBER, SEE PAGES 262-269.

## CABLE GRIPS

### PULLING GRIPS Heavy Duty

K-type pulling grips feature a double weave of galvanized steel for greater strength and added mesh contact with the cable as well as a forged steel compact rotating eye, which can be attached to a swivel. They are designed to handle longer or heavier pulling jobs such as an installation of underground cables, communication lines and service lines.

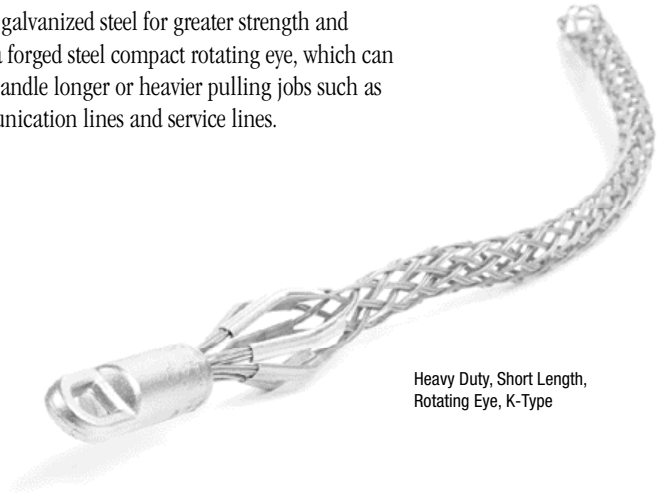

Heavy Duty, Short Length,  
Rotating Eye, K-Type

#### Heavy Duty, Short Length, Rotating Eye, K-Type

| CABLE DIAMETER RANGE | PART NO. | MESH LENGTH | EYE DIAMETER | APPROXIMATE BREAK STRENGTH <sup>1</sup> |
|----------------------|----------|-------------|--------------|---|
| 0.500-0.610"         | 35850    | 11"         | 7/8"         | 5,600 LBS.                              |
| 0.620-0.740"         | 35851    | 11"         | 7/8"         | 6,800 LBS.                              |
| 0.750-0.990"         | 35867    | 20"         | 1"           | 9,600 LBS.                              |
| 1.000-1.240"         | 35868    | 20"         | 1-3/8"       | 16,400 LBS.                             |
| 1.250-1.490"         | 35869    | 21"         | 1-3/8"       | 16,400 LBS.                             |
| 1.500-1.990"         | 35870    | 25"         | 1-5/8"       | 27,200 LBS.                             |
| 2.000-2.490"         | 35871    | 26"         | 1-7/8"       | 33,000 LBS.                             |
| 2.500-2.990"         | 35872    | 28"         | 1-7/8"       | 41,000 LBS.                             |
| 3.000-3.490"         | 35873    | 30"         | 1-7/8"       | 48,000 LBS.                             |
| 3.500-3.990"         | 35874    | 32"         | 1-7/8"       | 48,000 LBS.                             |
| 4.000-4.490"         | 35875    | 33"         | 1-7/8"       | 48,000 LBS.                             |

#### Heavy Duty, Standard Length, Rotating Eye, K-Type

| CABLE DIAMETER RANGE | PART NO. | MESH LENGTH | EYE DIAMETER | APPROXIMATE BREAK STRENGTH <sup>1</sup> |
|----------------------|----------|-------------|--------------|---|
| 0.500-0.610"         | 35865    | 16"         | 7/8"         | 5,600 LBS.                              |
| 0.620-0.740"         | 35866    | 16"         | 7/8"         | 6,800 LBS.                              |
| 0.750-0.990"         | 35880    | 32"         | 1"           | 9,600 LBS.                              |
| 1.000-1.490"         | 35881    | 33"         | 1-3/8"       | 16,400 LBS.                             |
| 1.500-1.990"         | 35882    | 34"         | 1-3/8"       | 16,400 LBS.                             |
| 2.000-2.490"         | 35883    | 36"         | 1-5/8"       | 27,200 LBS.                             |
| 2.500-2.990"         | 35884    | 38"         | 1-7/8"       | 33,000 LBS.                             |
| 3.000-3.490"         | 35885    | 39"         | 1-7/8"       | 41,000 LBS.                             |
| 3.500-3.990"         | 35886    | 41"         | 1-7/8"       | 48,000 LBS.                             |
| 4.000-4.490"         | 35887    | 42"         | 1-7/8"       | 48,000 LBS.                             |
| 4.500-4.990"         | 35897    | 58"         | 1-7/8"       | 48,000 LBS.                             |
| 5.000-5.990"         | 35898    | 60"         | 1-7/8"       | 48,000 LBS.                             |
| 6.000-6.990"         | 35899    | 66"         | 1-7/8"       | 48,000 LBS.                             |

<sup>1</sup> TO DETERMINE WORKLOAD SAFETY FACTOR, DIVIDE APPROXIMATE BREAK STRENGTH BY 5.  
SEE PAGE 187 FOR STRENGTH INFORMATION.

#### Heavy Duty, Standard Length, Rotating Eye Kit

| DESCRIPTION   | PART NO. |
|---|----------|
| KIT: T-TYPE CONTAINS 1 EACH OF 35880, 35881, 35882, 35883 | 36010    |



MOST WOODHEAD PRODUCTS HAVE U.L. AND/OR CSA APPROVALS.  
FOR A LISTING OF APPROVALS BY PART NUMBER, SEE PAGES 262-269.

**PULLING GRIPS Multi-Weave**

Multi-weave pulling grips are constructed of high strength galvanized steel and are designed for pulling aluminum or copper bare conductor, wire rope and insulated cables. These grips are used in applications such as distribution line stringing and overhead transmission. Multi-weave pulling grips are available with a flexible and rotating eye, which can be attached to a swivel.



Multi-Weave, Flexible Eye

**Multi-Weave, Rotating Eye**

The forged steel rotating eye will thread through sheaves and blocks without binding, but is not a swivel and will not turn under tension. The rotating eye can turn to relieve pulling torque when tension is relaxed.

| CABLE DIAMETER RANGE | PART NO. | MESH LENGTH | EYE DIAMETER | COLOR CODE         | APPROXIMATE BREAK STRENGTH <sup>1</sup> |
|----------------------|----------|-------------|--------------|--------------------|---|
| 0.250-0.490"         | 36620    | 26"         | 7/8"         | DK GREEN           | 6,800 LBS.                              |
| 0.500-0.740"         | 36621    | 32"         | 1"           | BROWN              | 10,000 LBS.                             |
| 0.750-0.990"         | 36622    | 41"         | 1"           | LT BLUE            | 14,400 LBS.                             |
| 1.000-1.240"         | 36623    | 52"         | 1-3/8"       | GOLD               | 24,600 LBS.                             |
| 1.250-1.490"         | 36624    | 56"         | 1-5/8"       | BLACK              | 30,600 LBS.                             |
| 1.500-1.740"         | 36625    | 60"         | 1-7/8"       | RED                | 30,600 LBS.                             |
| 1.750-2.240"         | 36626    | 70"         | 1-7/8"       | DK BLUE            | 48,000 LBS.                             |
| 2.000-2.490"         | 36627    | 50"         | 1-7/8"       | YELLOW             | 48,000 LBS.                             |
| 2.500-2.990"         | 36628    | 52"         | 1-7/8"       | ORANGE             | 48,000 LBS.                             |
| 3.000-3.490"         | 36629    | 54"         | 1-7/8"       | ALUM <sup>UM</sup> | 48,000 LBS.                             |
| 3.500-3.990"         | 36630    | 56"         | 1-7/8"       | LT GREEN           | 48,000 LBS.                             |

**Multi-Weave, Flexible Eye**

| CABLE DIAMETER RANGE | PART NO. | MESH LENGTH | EYE DIAMETER | COLOR CODE | APPROXIMATE BREAK STRENGTH <sup>1</sup> |
|----------------------|----------|-------------|--------------|------------|---|
| 0.250-0.490"         | 36640    | 26"         | 1/4"         | DK GREEN   | 6,800 LBS.                              |
| 0.500-0.740"         | 36641    | 32"         | 5/16"        | BROWN      | 10,000 LBS.                             |
| 0.750-0.990"         | 36642    | 41"         | 3/8"         | LT BLUE    | 14,400 LBS.                             |
| 1.000-1.240"         | 36643    | 52"         | 1/2"         | GOLD       | 24,600 LBS.                             |
| 1.250-1.490"         | 36644    | 56"         | 1/2"         | BLACK      | 30,600 LBS.                             |
| 1.500-1.740"         | 36645    | 60"         | 1/2"         | RED        | 30,600 LBS.                             |
| 1.750-2.240"         | 36646    | 70"         | 5/8"         | DK BLUE    | 48,000 LBS.                             |
| 2.000-2.490"         | 36647    | 50"         | 5/8"         | YELLOW     | 48,000 LBS.                             |
| 2.500-2.990"         | 36648    | 52"         | 5/8"         | ORANGE     | 48,000 LBS.                             |
| 3.000-3.490"         | 36649    | 54"         | 5/8"         | ALUMINUM   | 48,000 LBS.                             |
| 3.500-3.990"         | 36650    | 56"         | 5/8"         | LT GREEN   | 48,000 LBS.                             |

<sup>1</sup> TO DETERMINE WORKLOAD SAFETY FACTOR, DIVIDE APPROXIMATE BREAK STRENGTH BY 5. SEE PAGE 187 FOR STRENGTH INFORMATION.

NOTE: IT IS RECOMMENDED THAT A SWIVEL BE USED FOR RELEASE OF TORQUE DURING A PULL. USE A CONNECTING LINK WHEN A SWIVEL IS NOT NEEDED. DO NOT RUN GRIPS OR SWIVELS OVER BULLWHEELS WHILE UNDER TENSION. DO NOT USE MULTI-WEAVE FOR PULLING ROPE. WHEN HIGHER LOADS ARE REQUIRED, USE WOODHEAD'S HIGH STRENGTH-STYLE PULLING GRIPS. SEE INSTALLATION INSTRUCTIONS SUPPLIED WITH GRIP FOR RECOMMENDED SWIVELS, LINKS AND CLAMPS OR ACCESSORIES LISTING.

 MOST WOODHEAD PRODUCTS HAVE U.L. AND/OR CSA APPROVALS. FOR A LISTING OF APPROVALS BY PART NUMBER, SEE PAGES 262-269.



## CABLE GRIPS

### PULLING GRIPS High Strength

High strength pulling grips are designed for situations where loads and safety considerations require an extra high strength grip. They are most commonly used for attaching pulling lines to conductors, conductors to running boards and conductor-to-conductor connections. These grips can be used for pulling bare or insulated conductor, wire rope or synthetic rope.



High Strength, Flexible Eye

### High Strength, Flexible Eye

| CABLE DIAMETER RANGE <sup>1</sup> | PART NO. | MESH LENGTH | EYE DIAMETER | COLOR    | APPROXIMATE BREAK STRENGTH <sup>2</sup> |
|-----------------------------------|----------|-------------|--------------|----------|---|
| 0.190-0.370"                      | 36610    | 24"         | 7/32"        | BLACK    | 6,500 LBS.                              |
| 0.380-0.620"                      | 36611    | 26"         | 3/8"         | DK GREEN | 14,400 LBS.                             |
| 0.630-0.870"                      | 36612    | 48"         | 7/16"        | RED      | 20,000 LBS.                             |
| 0.880-1.120"                      | 36613    | 60"         | 1/2"         | DK BLUE  | 30,600 LBS.                             |
| 1.130-1.370"                      | 36614    | 76"         | 5/8"         | YELLOW   | 46,800 LBS.                             |
| 1.380-1.900"                      | 36615    | 89"         | 3/4"         | ALUMINUM | 66,500 LBS.                             |

<sup>1</sup> FOR ROPE, SELECT SMALLEST SIZE GRIP WHICH MEETS REQUIRED WORKLOAD.

<sup>2</sup> TO DETERMINE WORKLOAD SAFETY FACTOR, DIVIDE APPROXIMATE BREAK STRENGTH BY 5. SEE PAGE 187 FOR STRENGTH INFORMATION.

### Rope Assembly Using High Strength Feed Tube

A feed tube is recommended when assembling synthetic rope into the High Strength Pulling Grip and is required on the two largest grip sizes.

1. Insert feed tube into High Strength Pulling Grip.
2. Insert rope end fully into feed tube.
3. Hold rope in feed tube by pinning rope to the ground with end of tube. Pull mesh down onto feed so feed tube nose is protruding through shoulder protectors.
4. Push mesh to end of feed tube and pull feed tube through mesh. When pulled, the mesh gripping action will hold rope in place.
5. Position rope so that its end is inside the shoulder protectors. Remove slack by smoothing mesh tight to rope.
6. Apply clamps to mesh end as necessary.



MOST WOODHEAD PRODUCTS HAVE U.L. AND/OR CSA APPROVALS.  
FOR A LISTING OF APPROVALS BY PART NUMBER, SEE PAGES 262-269.

## PULLING GRIPS Fiber Optic

Fiber Optic pulling grips are used for installation of fiber optic communication lines. Easily installed on cables and reusable. Applications include underground, overhead, through conduit and/or enclosure-type pulls.





Fiber Optic, Closed Mesh, Rotating Eye

### Fiber Optic, Closed Mesh, Rotating Eye

| CABLE DIAMETER RANGE | PART NO. | APPROXIMATE BREAK STRENGTH <sup>1</sup> | MESH LENGTH | BALE LENGTH | NOSE DIAMETER |
|----------------------|----------|---|-------------|-------------|---------------|
| 0.100-0.200"         | 36660    | 1,000 LBS.                              | 9"          | 4.75"       | 0.8"          |
| 0.210-0.350"         | 36661    | 1,500 LBS.                              | 14"         | 4.75"       | 0.8"          |
| 0.350-0.480"         | 36662    | 2,200 LBS.                              | 18"         | 5.00"       | 0.9"          |
| 0.420-0.610"         | 36663    | 2,800 LBS.                              | 21"         | 5.00"       | 0.9"          |
| 0.530-0.740"         | 36664    | 3,300 LBS.                              | 24"         | 5.00"       | 1.2"          |
| 0.640-0.870"         | 36665    | 4,700 LBS.                              | 27"         | 5.00"       | 1.2"          |

<sup>1</sup> TO DETERMINE WORKLOAD SAFETY FACTOR, DIVIDE APPROXIMATE BREAK STRENGTH BY 5. SEE PAGE 187 FOR STRENGTH INFORMATION.



 MOST WOODHEAD PRODUCTS HAVE U.L. AND/OR CSA APPROVALS.  
 FOR A LISTING OF APPROVALS BY PART NUMBER, SEE PAGES 262-269.

## CABLE GRIPS

### PULLING GRIPS Slack

Slack grips are reusable grips used for pulling slack in underground cable preparatory to final placement. They may also be used for cable removal. Slack grips feature an offset eye for easy attachment to the pulling line.



Double Weave, Standard Length,  
Closed Mesh, Offset Eye

### Double Weave, Standard Length, Closed Mesh, Offset Eye

| CABLE DIAMETER RANGE | PART NO. | MESH LENGTH | APPROXIMATE BREAK STRENGTH <sup>1</sup> |
|----------------------|----------|-------------|---|
| 0.750-0.990"         | 36101    | 13"         | 3,000 LBS.                              |
| 1.000-1.240"         | 36102    | 16"         | 4,200 LBS.                              |
| 1.250-1.490"         | 36103    | 17"         | 5,500 LBS.                              |
| 1.500-1.740"         | 36104    | 18"         | 7,400 LBS.                              |
| 1.750-1.990"         | 36105    | 19"         | 11,000 LBS.                             |
| 2.000-2.490"         | 36106    | 20"         | 11,000 LBS.                             |
| 2.500-2.990"         | 36107    | 21"         | 11,000 LBS.                             |
| 3.000-3.490"         | 36108    | 22"         | 16,000 LBS.                             |
| 3.500-3.990"         | 36109    | 23"         | 16,000 LBS.                             |

### Double Weave, Long Length, Closed Mesh, Offset Eye

| CABLE DIAMETER RANGE | PART NO. | MESH LENGTH | APPROXIMATE BREAK STRENGTH <sup>1</sup> |
|----------------------|----------|-------------|---|
| 0.750-0.990"         | 36111    | 21"         | 3,000 LBS.                              |
| 1.000-1.240"         | 36112    | 21"         | 5,500 LBS.                              |
| 1.250-1.490"         | 36113    | 24"         | 5,500 LBS.                              |
| 1.500-1.740"         | 36114    | 26"         | 7,400 LBS.                              |
| 2.000-2.490"         | 36115    | 27"         | 11,000 LBS.                             |
| 2.500-2.990"         | 36116    | 30"         | 11,000 LBS.                             |
| 3.000-3.490"         | 36117    | 33"         | 16,000 LBS.                             |
| 3.500-3.990"         | 36118    | 36"         | 16,000 LBS.                             |

<sup>1</sup> TO DETERMINE WORKLOAD SAFETY FACTOR, DIVIDE APPROXIMATE BREAK STRENGTH BY 5.  
SEE PAGE 187 FOR STRENGTH INFORMATION.



MOST WOODHEAD PRODUCTS HAVE U.L. AND/OR CSA APPROVALS.  
FOR A LISTING OF APPROVALS BY PART NUMBER, SEE PAGES 262-269.

## PULLING GRIPS Slack

Double Weave, Standard Length, Split Lace, Offset Eye

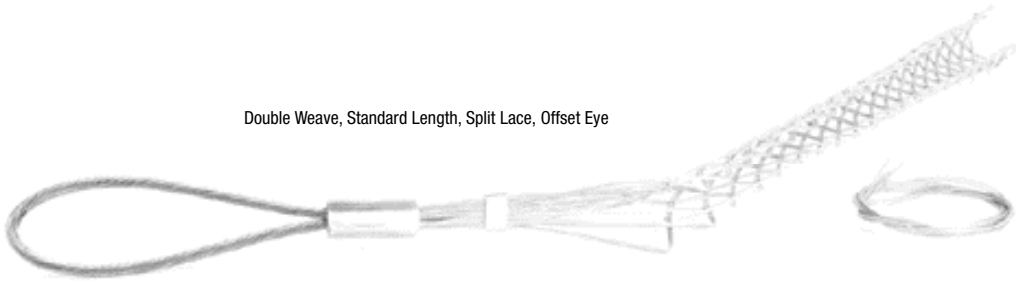

### Double Weave, Standard Length, Split Lace, Offset Eye

| CABLE DIAMETER RANGE | PART NO. | MESH LENGTH | APPROXIMATE BREAK STRENGTH <sup>1</sup> |
|----------------------|----------|-------------|---|
| 0.750-0.990"         | 36120    | 13"         | 3,000 LBS.                              |
| 1.000-1.240"         | 36121    | 16"         | 4,100 LBS.                              |
| 1.250-1.490"         | 36122    | 17"         | 4,100 LBS.                              |
| 1.500-1.740"         | 36123    | 18"         | 5,500 LBS.                              |
| 1.750-1.990"         | 36124    | 19"         | 7,300 LBS.                              |
| 2.000-2.490"         | 36125    | 20"         | 7,300 LBS.                              |
| 2.500-2.990"         | 36126    | 21"         | 7,300 LBS.                              |
| 3.000-3.490"         | 36127    | 22"         | 9,200 LBS.                              |
| 3.500-3.990"         | 36128    | 23"         | 11,000 LBS.                             |

### Double Weave, Long Length, Split Lace, Offset Eye

| CABLE DIAMETER RANGE | PART NO. | MESH LENGTH | APPROXIMATE BREAK STRENGTH <sup>1</sup> |
|----------------------|----------|-------------|---|
| 0.750-0.990"         | 36130    | 21"         | 3,000 LBS.                              |
| 1.000-1.240"         | 36131    | 21"         | 4,100 LBS.                              |
| 1.250-1.490"         | 36132    | 24"         | 4,100 LBS.                              |
| 1.500-1.740"         | 36133    | 25"         | 5,500 LBS.                              |
| 2.000-2.490"         | 36134    | 27"         | 7,300 LBS.                              |
| 2.500-2.990"         | 36135    | 30"         | 7,300 LBS.                              |
| 3.000-3.490"         | 36136    | 33"         | 9,200 LBS.                              |
| 3.500-3.990"         | 36137    | 36"         | 11,000 LBS.                             |

### Single Weave, Standard Length, Split Rod, Offset Eye

| CABLE DIAMETER RANGE | PART NO. | MESH LENGTH | APPROXIMATE BREAK STRENGTH <sup>1</sup> |
|----------------------|----------|-------------|---|
| 0.500-0.610"         | 36140    | 7"          | 1800 LBS.                               |
| 0.620-0.740"         | 36141    | 9"          | 1900 LBS.                               |
| 0.750-0.990"         | 36142    | 11"         | 3000 LBS.                               |
| 1.000-1.240"         | 36143    | 12"         | 4100 LBS.                               |
| 1.250-1.490"         | 36144    | 14"         | 5700 LBS.                               |
| 1.500-1.740"         | 36145    | 16"         | 5800 LBS.                               |
| 1.750-1.990"         | 36146    | 17"         | 7700 LBS.                               |
| 2.000-2.490"         | 36147    | 20"         | 9300 LBS.                               |
| 2.500-2.990"         | 36148    | 21"         | 11,300 LBS.                             |
| 3.000-3.490"         | 36149    | 22"         | 15,100 LBS.                             |
| 3.500-3.990"         | 36150    | 25"         | 15,100 LBS.                             |

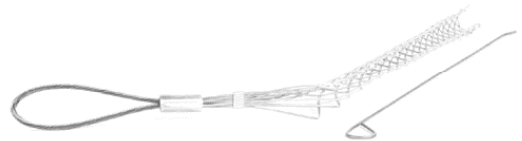

Single Weave, Standard Length, Split Rod, Offset Eye

<sup>1</sup> TO DETERMINE WORKLOAD SAFETY FACTOR, DIVIDE APPROXIMATE BREAK STRENGTH BY 5. SEE PAGE 187 FOR STRENGTH INFORMATION.



MOST WOODHEAD PRODUCTS HAVE U.L. AND/OR CSA APPROVALS. FOR A LISTING OF APPROVALS BY PART NUMBER, SEE PAGES 262-269.

# CABLE GRIPS

## SELECTING PROPERLY SIZED PULLING AND SUPPORT GRIPS

Select grip size based upon the outside diameter or circumference of the cable(s). See the following reference tables for convenience in determining cable diameters.

Use the following grip selection tables to determine the grip diameter range for your application.

### Grip selection for one or more cables of equal diameter

1. Read across top line for number of cables in one grip.
2. Read down for diameter of each cable.
3. Read across to the right to grip diameter range column.

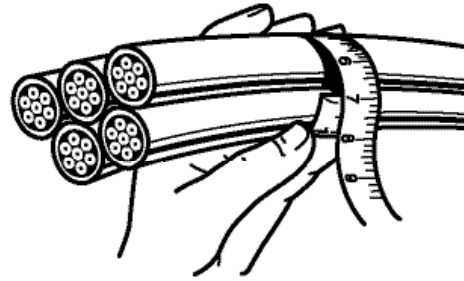

Example: For five cables together with diameter of 0.42" each

1. Locate "5 cables" column.
2. Read down column to range (0.38–0.48").
3. Read across line to grip diameter range (1.00–1.25").

### Decimal and Fractional Inch Cable Diameters – For One or More Cables of Equal Diameter

| 1 CABLE             | 2 CABLES  | 3 CABLES  | 4 CABLES  | GRIP DIAMETER RANGE |
|---------------------|---|---|---|---------------------|
| 0.25-0.37 = ¼ - ¾   | 0.16-0.25 = ¼ <sub>64</sub> - ¼                 | 0.15-0.22 = ⅜ <sub>64</sub> - ⅜ <sub>64</sub>   | 0.12-0.20 = ⅙ - ⅙ <sub>64</sub>                 | 0.25-0.375          |
| 0.37-0.50 = ⅜ - ½   | 0.25-0.36 = ¼ - ⅜ <sub>64</sub>                 | 0.22-0.33 = ⅜ <sub>64</sub> - ⅜ <sub>64</sub>   | 0.20-0.28 = ⅙ <sub>64</sub> - ⅙ <sub>64</sub>   | 0.375-0.50          |
| 0.50-0.62 = ½ - ¾   | 0.27-0.36 = ⅙ <sub>64</sub> - ⅜ <sub>64</sub>   | 0.26-0.33 = ⅙ <sub>64</sub> - ⅜ <sub>64</sub>   | 0.24-0.28 = ⅙ <sub>64</sub> - ⅜ <sub>64</sub>   | 0.50-0.62           |
| 0.62-0.75 = ¾ - 1   | 0.36-0.45 = ⅜ <sub>64</sub> - ⅜ <sub>64</sub>   | 0.33-0.36 = ⅜ <sub>64</sub> - ⅜ <sub>64</sub>   | 0.28-0.31 = ⅜ <sub>64</sub> - ⅜ <sub>64</sub>   | 0.62-0.75           |
| 0.75-1.00 = ¾ - 1   | 0.45-0.60 = ⅜ <sub>64</sub> - ⅜ <sub>64</sub>   | 0.36-0.49 = ⅜ <sub>64</sub> - ⅜ <sub>64</sub>   | 0.31-0.42 = ⅜ <sub>64</sub> - ⅜ <sub>64</sub>   | 0.75-1.00           |
| 1.00-1.25 = 1 - 1½  | 0.60-0.76 = ⅜ <sub>64</sub> - ⅜ <sub>64</sub>   | 0.49-0.63 = ⅜ <sub>64</sub> - ⅜ <sub>64</sub>   | 0.42-0.54 = ⅜ <sub>64</sub> - ⅜ <sub>64</sub>   | 1.00-1.25           |
| 1.25-1.50 = 1¼ - 1½ | 0.76-0.91 = ⅜ <sub>64</sub> - ⅜ <sub>64</sub>   | 0.63-0.75 = ⅜ <sub>64</sub> - ⅜ <sub>64</sub>   | 0.54-0.65 = ⅜ <sub>64</sub> - ⅜ <sub>64</sub>   | 1.25-1.50           |
| 1.50-1.75 = 1½ - 1¾ | 0.91-1.08 = ⅜ <sub>64</sub> - 1⅜ <sub>64</sub>  | 0.76-0.89 = ⅜ <sub>64</sub> - ⅜ <sub>64</sub>   | 0.65-0.77 = ⅜ <sub>64</sub> - ⅜ <sub>64</sub>   | 1.50-1.75           |
| 1.75-2.00 = 1¾ - 2  | 1.23-1.54 = 1⅜ <sub>64</sub> - 1⅜ <sub>64</sub> | 0.89-1.02 = ⅜ <sub>64</sub> - 1⅜ <sub>64</sub>  | 0.77-0.88 = ⅜ <sub>64</sub> - ⅜ <sub>64</sub>   | 1.75-2.00           |
| 2.00-2.50 = 2 - 2½  | 1.54-1.84 = 1⅜ <sub>64</sub> - 1⅜ <sub>64</sub> | 1.02-1.28 = 1¼ - 1½ <sub>64</sub>               | 0.88-1.00 = ⅜ - 1                               | 2.00-2.50           |
| 2.50-3.00 = 2½ - 3  | 1.54-1.84 = 1⅜ <sub>64</sub> - 1½ <sub>64</sub> | 1.28-1.53 = 1½ - 1½ <sub>64</sub>               | 1.10-1.32 = 1½ - 1½ <sub>64</sub>               | 2.50-3.00           |
| 3.00-3.50 = 3 - 3½  | 1.84-2.15 = 1½ <sub>64</sub> - ⅜ <sub>64</sub>  | 1.53-1.79 = 1½ <sub>64</sub> - 1½ <sub>64</sub> | 1.32-1.54 = 1½ <sub>64</sub> - 1½ <sub>64</sub> | 3.00-3.50           |
| 3.50-4.00 = 3½ - 4  | 2.15-2.45 = 2½ <sub>64</sub> - 2½ <sub>64</sub> | 1.79-2.05 = 1½ <sub>64</sub> - 2½ <sub>64</sub> | 1.54-1.76 = 1½ <sub>64</sub> - 1½ <sub>64</sub> | 3.50-4.00           |

| 5 CABLES  | 6 & 7 CABLES                                    | 8 CABLES  | 9 CABLES                                      | GRIP DIAMETER RANGE |
|---|---|---|---|---------------------|
| 0.11-0.14 = ⅙ <sub>64</sub> - ⅙ <sub>64</sub>   | 0.10-0.11 = ⅜ <sub>64</sub> - ⅜ <sub>64</sub>   | 0.09-0.10 = ⅜ <sub>64</sub> - ⅜ <sub>64</sub>   | 0.06-0.09 = ⅙ <sub>64</sub> - ⅜ <sub>64</sub> | 0.25-0.375          |
| 0.14-0.21 = ⅙ <sub>64</sub> - ¼                 | 0.11-0.25 = ⅙ <sub>64</sub> - ¼                 | 0.10-0.20 = ⅙ <sub>64</sub> - ⅙ <sub>64</sub>   | 0.09-0.19 = ⅜ <sub>64</sub> - ⅜ <sub>64</sub> | 0.375-0.50          |
| 0.21-0.25 = ⅜ <sub>64</sub> - ¼                 | 0.19-0.22 = ⅜ <sub>64</sub> - ⅜ <sub>64</sub>   | 0.17-0.20 = ⅙ <sub>64</sub> - ⅙ <sub>64</sub>   | 0.15-0.19 = ⅜ <sub>64</sub> - ⅜ <sub>64</sub> | 0.50-0.62           |
| 0.25-0.29 = ¼ - ⅙ <sub>64</sub>                 | 0.22-0.26 = ⅜ <sub>64</sub> - ⅙ <sub>64</sub>   | 0.20-0.23 = ⅙ <sub>64</sub> - ⅙ <sub>64</sub>   | 0.19-0.22 = ⅜ <sub>64</sub> - ⅜ <sub>64</sub> | 0.62-0.75           |
| 0.29-0.38 = ⅙ <sub>64</sub> - ⅜                 | 0.26-0.34 = ⅙ <sub>64</sub> - 1½ <sub>64</sub>  | 0.23-0.31 = ⅙ <sub>64</sub> - ⅜ <sub>64</sub>   | 0.22-0.31 = ⅜ <sub>64</sub> - ⅜ <sub>64</sub> | 0.75-1.00           |
| 0.38-0.48 = ⅜ <sub>64</sub> - ⅜ <sub>64</sub>   | 0.34-0.43 = ⅙ <sub>64</sub> - ⅜ <sub>64</sub>   | 0.31-0.39 = ⅜ <sub>64</sub> - ⅜ <sub>64</sub>   | 0.29-0.36 = ⅙ <sub>64</sub> - ⅜ <sub>64</sub> | 1.00-1.25           |
| 0.48-0.58 = ⅜ <sub>64</sub> - ⅜ <sub>64</sub>   | 0.43-0.52 = ⅜ <sub>64</sub> - ⅜ <sub>64</sub>   | 0.39-0.46 = ⅜ <sub>64</sub> - 1½ <sub>64</sub>  | 0.36-0.43 = ⅜ <sub>64</sub> - ⅜ <sub>64</sub> | 1.25-1.50           |
| 0.58-0.67 = ⅜ <sub>64</sub> - ⅜ <sub>64</sub>   | 0.52-0.60 = ⅜ <sub>64</sub> - ⅜ <sub>64</sub>   | 0.46-0.54 = ⅜ <sub>64</sub> - ⅜ <sub>64</sub>   | 0.43-0.49 = ⅜ <sub>64</sub> - ⅜ <sub>64</sub> | 1.50-1.75           |
| 0.67-0.77 = ⅜ <sub>64</sub> - ⅜ <sub>64</sub>   | 0.60-0.69 = ⅜ <sub>64</sub> - 1½ <sub>64</sub>  | 0.54-0.62 = ⅜ <sub>64</sub> - ⅜ <sub>64</sub>   | 0.49-0.57 = ⅜ <sub>64</sub> - ⅜ <sub>64</sub> | 1.75-2.00           |
| 0.77-0.96 = ⅜ <sub>64</sub> - ⅜ <sub>64</sub>   | 0.69-0.86 = ⅙ <sub>64</sub> - ⅜ <sub>64</sub>   | 0.62-0.77 = ⅜ <sub>64</sub> - ⅜ <sub>64</sub>   | 0.57-0.72 = ⅜ <sub>64</sub> - ⅜ <sub>64</sub> | 2.00-2.50           |
| 0.96-1.16 = ⅜ <sub>64</sub> - 1½ <sub>64</sub>  | 0.86-1.03 = ⅜ <sub>64</sub> - 1½ <sub>64</sub>  | 0.77-0.93 = ⅜ <sub>64</sub> - ⅜ <sub>64</sub>   | 0.72-0.86 = ⅜ <sub>64</sub> - ⅜ <sub>64</sub> | 2.50-3.00           |
| 1.16-1.35 = 1½ <sub>64</sub> - 1½ <sub>64</sub> | 1.03-1.20 = 1½ <sub>64</sub> - 1½ <sub>64</sub> | 0.93-1.08 = ⅜ <sub>64</sub> - 1½ <sub>64</sub>  | 0.86-1.00 = ⅜ <sub>64</sub> - 1               | 3.00-3.50           |
| 1.35-1.54 = 1½ <sub>64</sub> - 1½ <sub>64</sub> | 1.20-1.37 = 1½ <sub>64</sub> - 1½               | 1.08-1.24 = 1½ <sub>64</sub> - 1½ <sub>64</sub> | 1.00-1.14 = 1 - 1½ <sub>64</sub>              | 3.50-4.00           |

**SELECTING PROPERLY SIZED PULLING AND SUPPORT GRIPS**

Grip circumference range refers to circumference of all cables held together.

1. Determine grip circumference range by measuring circumference of bundle of cables to be held (as shown in illustration).
2. Read down to locate correct range.
3. Read across to grip diameter column.

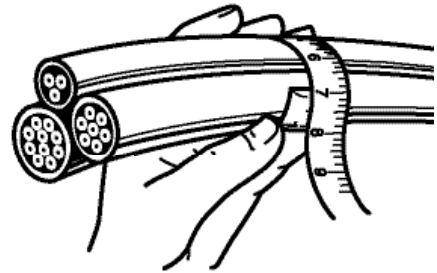

Example: For three cables together with combined circumference of 6.35"

1. Read down "inches (decimal)" column for 6.35" (6.29-7.86").
2. Read across line to grip diameter range (2.00-2.50").

**Grip Circumference Range -  
For Cables of Different Diameters**

| INCHES (FRACTIONAL)                    | INCHES (DECIMAL) | GRIP DIAMETER RANGE |
|--|------------------|---------------------|
| $\frac{5}{16}$ - $1\frac{1}{16}$ "     | 0.78-1.17"       | 0.25-.375"          |
| $1\frac{1}{16}$ - $1\frac{3}{16}$ "    | 1.17-1.57"       | 0.375-0.50"         |
| $1\frac{3}{16}$ - $2\frac{1}{16}$ "    | 1.57-2.37"       | 0.50-0.75"          |
| $1\frac{5}{16}$ - $2\frac{3}{16}$ "    | 1.94-2.37"       | 0.625-0.75"         |
| $2\frac{1}{16}$ - $3\frac{1}{32}$ "    | 2.37-3.15"       | 0.75-1.00"          |
| $3\frac{1}{32}$ - $3\frac{15}{16}$ "   | 3.15-3.94"       | 1.00-1.25"          |
| $3\frac{1}{16}$ - 4"                   | 3.94-4.72"       | 1.25-1.50"          |
| $4\frac{3}{32}$ - $5\frac{3}{16}$ "    | 4.72-5.51"       | 1.50-1.75"          |
| $5\frac{1}{16}$ - $6\frac{1}{16}$ "    | 5.51-6.29"       | 1.75-2.00"          |
| $6\frac{1}{16}$ - $7\frac{5}{16}$ "    | 6.29-7.86"       | 2.00-2.50"          |
| $7\frac{5}{16}$ - $9\frac{1}{16}$ "    | 7.86-9.43"       | 2.50-3.00"          |
| $9\frac{1}{16}$ - $11\frac{1}{16}$ "   | 9.43-11.01"      | 3.00-3.50"          |
| $11\frac{1}{16}$ - $12\frac{31}{64}$ " | 11.01-12.58"     | 3.50-4.00"          |

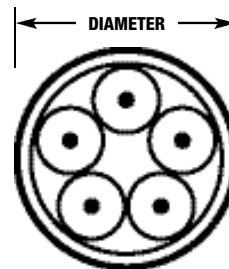

**Reference Table: Cord Diameters**

For your convenience, the following are nominal overall diameters (in inches) for flexible cord.

| AWG WIRE SIZE AND TYPE | 2 CONDUCTORS | 3 CONDUCTORS | 4 CONDUCTORS | 5 CONDUCTORS |
|------------------------|--------------|--------------|--------------|--------------|
| 18 SO, STO             | 0.36"        | 0.38"        | 0.41"        | 0.49"        |
| 18 SJO, SJTO           | 0.30"        | 0.32"        | 0.35"        | —            |
| 16 SO, STO             | 0.39"        | 0.41"        | 0.44"        | 0.52"        |
| 16 SJO, SJTO           | 0.32"        | 0.34"        | 0.37"        | —            |
| 14 SO, STO             | 0.52"        | 0.55"        | 0.59"        | 0.67"        |
| 12 SO, STO             | 0.60"        | 0.62"        | 0.68"        | 0.74"        |
| 10 SO, STO             | 0.65"        | 0.69"        | 0.74"        | 0.80"        |
| 8 SO, STO              | 0.83"        | 0.88"        | 0.99"        | 1.08"        |
| 6 SO, STO              | 0.99"        | 1.04"        | 1.12"        | 1.25"        |



## CABLE GRIPS

### PULLING AND SUPPORT GRIPS

This table to be used as a guide only. Sizes may vary by manufacturer.

#### AWG or MCM Wire Sizes

| AWG OR MCM | APPROXIMATE DIAMETER<br>THHM | APPROXIMATE DIAMETER<br>THW |
|------------|------------------------------|-----------------------------|
| 14         | 0.105"                       | 0.162"                      |
| 12         | 0.122"                       | 0.179"                      |
| 10         | 0.153"                       | 0.199"                      |
| 8          | 0.201"                       | 0.259"                      |
| 6          | 0.257"                       | 0.323"                      |
| 4          | 0.328"                       | 0.372"                      |
| 3          | 0.356"                       | 0.401"                      |
| 2          | 0.388"                       | 0.433"                      |
| 1          | 0.450"                       | 0.508"                      |
| 1/0        | 0.491"                       | 0.549"                      |
| 2/0        | 0.537"                       | 0.595"                      |
| 3/0        | 0.588"                       | 0.647"                      |
| 4/0        | 0.646"                       | 0.705"                      |
| 250        | 0.716"                       | 0.788"                      |
| 300        | 0.771"                       | 0.843"                      |
| 350        | 0.822"                       | 0.895"                      |
| 400        | 0.869"                       | 0.942"                      |
| 500        | 0.955"                       | 1.03"                       |
| 600        | 1.06"                        | 1.14"                       |
| 700        | 1.13"                        | 1.21"                       |
| 750        | 1.16"                        | 1.25"                       |
| 1000       | 1.32"                        | 1.40"                       |

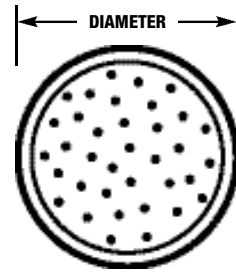

PULLING AND SUPPORT GRIPS

Strength Information

The approximate breaking strength of any Woodhead wire mesh cable grip is based on working load information established by Woodhead engineering laboratories. In making these determinations, it is not possible to cover all applications and operating conditions. Variables such as diameters, gripping surfaces, number of items gripped, tension, movement, attachment, abrasion, corrosion, prior use, or abuse must be assessed by the user. Greater safety factors should be utilized when the conditions of application are vague or unknown.

For specific applications where strength and holding power are important, consult the manufacturer. To determine the recommended working load safety factor for listed cable grips, divide the approximate breaking strength by 5 for pulling grips and 10 for support grips. Woodhead maintains a 6 sigma safety factor for pulling grips and a 5 sigma safety factor for support grips for these recommended working loads (using average break strengths obtained on new grips under lab test conditions).

Example: For pulling grips –  $33,000 \div 5 = 6,600$  lbs. which is the workload factor.

Example: For support grips –  $10,080 \div 10 = 1,008$  lbs. which is the workload factor.

All warranties concerning product quality or performance are based on wire mesh grips that are properly stored and handled by the user, and grips that are maintained and inspected at a proper frequency in keeping with their use and condition.

Grip Cable Range Conversion

| INCHES (FRACTIONAL) | INCHES (DECIMAL) | METRIC (MM)     |
|---------------------|------------------|-----------------|
| ¼ - ⅜"              | 0.25-0.36"       | 6.35-9.13 mm    |
| ½ - ⅝"              | 0.37-0.49"       | 9.52-12.30 mm   |
| ⅝ - ¾"              | 0.50-0.61"       | 12.70-15.48 mm  |
| ¾ - ⅞"              | 0.62-0.74"       | 15.88-18.65 mm  |
| ⅞ - 1"              | 0.75-0.99"       | 19.05-25.00 mm  |
| 1 - 1 1/8"          | 1.00-1.24"       | 25.40-31.35 mm  |
| 1 1/8 - 1 1/4"      | 1.25-1.49"       | 31.75-37.70 mm  |
| 1 1/4 - 1 1/2"      | 1.50-1.99"       | 38.10-50.40 mm  |
| 2 - 2 1/4"          | 2.00-2.49"       | 50.80-63.10 mm  |
| 2 1/2 - 2 3/4"      | 2.50-2.99"       | 63.50-75.80 mm  |
| 3 - 3 1/4"          | 3.00-3.49"       | 76.20-88.50 mm  |
| 3 1/2 - 3 3/4"      | 3.50-3.99"       | 88.90-101.20 mm |

Split-Lace

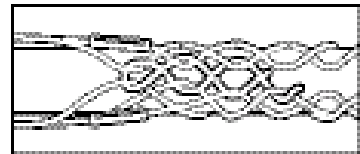

Split Lace/Split Rod attachments (for use where end of cable is not accessible)

Beginning at the end of the grip closest to the bale fitting, thread the lacing through the first two loops of the split, pulling lace through until ends are centered evenly. Cross laces and thread through next two loops, and so on down the grip, being careful not to pull lacing too tight. Spacing of laced closure should be approximately the same as mesh weave. When end of grip is reached, twist lacing strands tightly together, wrap ends of lace around grip, and twist again to secure. Excess length may be cut off.

Split grips with rod closing are economical, since they are quickly installed, and are reusable. Simply wrap the grip around the cable and thread the rod through the loops, using a corkscrew motion. To remove, pull the rod out, and the grip is ready for re-use.

Split-Rod

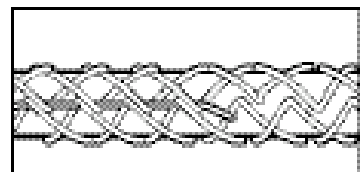
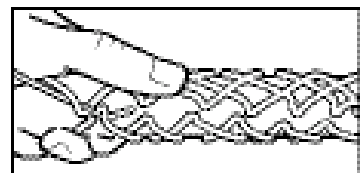





Woodhead offers both standard duty cord reels and industrial duty cable reels to meet a variety of specific power supply needs. All are engineered and built to provide a safe, dependable power supply over years of rugged service. For added safety, each features enclosed electrical contacts.

### **Cord Reels**

U.L. listed and CSA certified, standard duty Woodhead cord reels are renowned for their exceptional performance, long service life, and ease of maintenance. Made from precision electrical and mechanical components and offered in both swing and rigid mount versions, cord reels are ideal for keeping hand lamps and power outlet boxes accessible, yet out of the way.

Suitable for use with portable power supplies, mobile material handling equipment and portable lighting. Available with a variety of optional incandescent and fluorescent hand lamps.

### **Cable Reels**

Spring-powered industrial duty cable reels are made of precision electrical and mechanical components which can accommodate up to 160 feet of cable. Woodhead cable reels are suitable for use in situations requiring portable lighting and power tools or a movable power supply, including mobile electrical equipment and are appropriate for indoor or outdoor use, and available with and without cable.

# REELS

## STANDARD DUTY Cord Reels

Standard duty cord reels have a variety of optional accessories and are available in swinging or rigid mount versions. Reels come with enclosed electrical contacts, adjustable tension, and built in ratchet locks. Standard duty reels are exceptionally cost-effective and feature a durable steel/polycarbonate frame and retraction weight ratings up to 3 lbs.



980/990/997 SERIES REEL



945-3 SERIES REEL

**Standard Duty Cord Reels** Standard duty cord reels utilize SJTOW cord.

| WIRE GAUGE | CONDUCTORS | AMPERAGE | CORD | CONSTRUCTION        | RETRACTION | PART NO. |
|------------|------------|----------|------|---------------------|------------|----------|
| 16 AWG     | 3          | 6A       | 35'  | ALL STEEL           | 2 lbs.     | 945-3    |
| 16 AWG     | 3          | 8A       | 50'  | STEEL/POLYCARBONATE | 3 lbs.     | 980      |
| 14 AWG     | 3          | 11A      | 45'  | STEEL/POLYCARBONATE | 3 lbs.     | 990      |
| 12 AWG     | 3          | 15A      | 35'  | STEEL/POLYCARBONATE | 3 lbs.     | 997      |

SEE PAGES 204-205 FOR TECHNICAL INFORMATION

## Standard Duty Cord Reels with Accessories

Find information about other hand lamps on pages 6-25.

Find information about other portable power boxes on pages 134-151.

## Cord Reels with 13W Fluorescent Hand Lamp w/ Cord Ballast

| WITH REEL NO. | CORD TYPE  | CORD LENGTH | PART NO. |
|---------------|------------|-------------|----------|
| 980           | 16/3 SJTOW | 50'         | 980-83   |
| 990           | 14/3 SJTOW | 45'         | 990-83   |



### Hand Lamp Features



- rubber handle with butyrate tube guard
- on/off switch on handle
- ballast on reel primary cord
- bulb included
- insulated light (non-conductive)
- see part no. 1083-3 on page 16 for details



MOST WOODHEAD PRODUCTS HAVE U.L. AND/OR CSA APPROVALS.  
FOR A LISTING OF APPROVALS BY PART NUMBER, SEE PAGES 262-269.

**STANDARD DUTY Cord Reels with Accessories**

**Cord Reels with 13W Fluorescent Hand Lamp w/ Handle Ballast**

| WITH REEL NO.  | CORD TYPE                | CORD LENGTH | PART NO.         |
|--|--------------------------|-------------|------------------|
|  980<br>990 | 16/3 SJTOW<br>14/3 SJTOW | 50'<br>45'  | 980-86<br>990-86 |
|  945-3      | 16/3 SJTOW               | 35'         | 945-3-86         |

**Hand Lamp Features**

- rubber handle with butyrate tube guard
- on/off switch on handle
- ballast in handle
- bulb included
- insulated light (non-conductive)
- see part no. 1086-3 on page 16 for details



**Cord Reels with 13W Fluorescent Hand Lamp w/ Reel-mounted Switch**

| WITH REEL NO.  | CORD TYPE                | CORD LENGTH | PART NO.             |
|--|--------------------------|-------------|----------------------|
|  980<br>990 | 16/3 SJTOW<br>14/3 SJTOW | 50'<br>45'  | 980A-83'<br>990A-83' |

<sup>1</sup> MEETS THE REQUIREMENTS OF OSHA 110.303 GENERAL DUTY CLAUSE REGULATION (REF. NEC 511-3[F1])

**Hand Lamp Features**

- rubber handle w/ butyrate tube guard
- reel mounted on/off switch
- ballast on reel primary cord
- bulb included
- see part no. 1083-3 on page 16 for details





**Cord Reels with 100W Max Incandescent Hand Lamp w/ Phenolic Handle**

| WITH REEL NO.  | CORD TYPE                | CORD LENGTH | PART NO.               |
|--|--------------------------|-------------|------------------------|
|  980<br>990 | 16/3 SJTOW<br>14/3 SJTOW | 50'<br>45'  | 980-271US<br>990-271US |

**Hand Lamp Features**

- 125V
- NEMA 5-15 outlet in handle
- switch in handle
- see part no. 271US on page 20 for details





  MOST WOODHEAD PRODUCTS HAVE U.L. AND/OR CSA APPROVALS. FOR A LISTING OF APPROVALS BY PART NUMBER, SEE PAGES 262-269.



# REELS

## STANDARD DUTY Cord Reels with Accessories

### Cord Reels with 100W Max Incandescent Hand Lamp w/ Rubber Handle

| WITH REEL NO.   | CORD TYPE | CORD LENGTH | PART NO. |           |
|---|-----------|-------------|----------|-----------|
|  | 980       | 16/3 SJTOW  | 50'      | 980-106US |
|   | 990       | 14/3 SJTOW  | 45'      | 990-106US |
|  | 945-3     | 16/3 SJTOW  | 35'      | 963       |



#### Hand Lamp Features

- rubber handle with metal guard
- side outlet on handle
- on/off switch on handle
- see part no. 106US on page 14 for details

### Cord Reels with 100W Max Incandescent Hand Lamp w/ Nylon Guard

| WITH REEL NO.   | CORD TYPE | CORD LENGTH | PART NO. |           |
|---|-----------|-------------|----------|-----------|
|  | 980       | 16/3 SJTOW  | 50'      | 980A-118' |
|   | 990       | 14/3 SJTOW  | 45'      | 990A-118' |

<sup>1</sup> MEETS THE REQUIREMENTS OF OSHA 110.303 GENERAL DUTY CLAUSE REGULATION (REF. NEC 511-3[F1])



#### Hand Lamp Features

- rubber handle with nylon guard
- reel-mounted on/off switch
- insulated light (non-conductive)
- see page 15 for details

### Cord Reels with 30W Max Low Volt Incandescent Spot Light

| WITH REEL NO.   | CORD TYPE | CORD LENGTH | PART NO. |           |
|---|-----------|-------------|----------|-----------|
|  | 980       | 16/3 SJTOW  | 50'      | 980-1610S |
|   | 945-3     | 16/3 SJTOW  | 35'      | 965       |



#### Spot Light Features



- rubber handle with metal guard
- on/off switch on handle
- insulated light (non-conductive)
- 125V to 12V transformer located on primary side of reel
- see part no. 1610S on page 41 for details



MOST WOODHEAD PRODUCTS HAVE U.L. AND/OR CSA APPROVALS.  
FOR A LISTING OF APPROVALS BY PART NUMBER, SEE PAGES 262-269.

**STANDARD DUTY Cord Reels with Accessories**

**Cord Reels with 15A Pendant Outlet Box**

| WITH REEL NO.   | CORD TYPE | CORD LENGTH | PART NO. |          |
|---|-----------|-------------|----------|----------|
|  | 980       | 16/3 SJTOW  | 50'      | 980-3000 |
|   | 990       | 14/3 SJTOW  | 45'      | 990-3000 |
|   | 997       | 12/3 SJTOW  | 35'      | 997-3000 |
|  | 945-3     | 16/3 SJTOW  | 35'      | 966      |

**Outlet Box Features**

- two duplex, NEMA 5-15 outlets
- standard depth box – 3-3/8"
- see part no. 3000-1 on page 140 for details



**Cord Reels with 15A GFCI Pendant Outlet Box**



| WITH REEL NO.   | CORD TYPE | CORD LENGTH | PART NO. |           |
|---|-----------|-------------|----------|-----------|
|  | 980       | 16/3 SJTOW  | 50'      | 980-3070G |
|   | 990       | 14/3 SJTOW  | 45'      | 990-3070G |
|   | 997       | 12/3 SJTOW  | 35'      | 997-3070G |

**Outlet Box Features**

- GFCI duplex, NEMA 5-15
- extended depth box – 4 1/2"
- see part no. 3070-GFI on page 136 for details



**Cord Reels with 15A Connector**

| WITH REEL NO.   | CORD TYPE | CORD LENGTH | PART NO. |          |
|---|-----------|-------------|----------|----------|
|  | 980       | 16/3 SJTOW  | 50'      | 980-1547 |
|   | 990       | 14/3 SJTOW  | 45'      | 990-1547 |
|  | 945-3     | 16/3 SJTOW  | 35'      | 945-1547 |

**Connector Features**

- 15A/125V 2-pole, 3-wire
- NEMA 5-15
- see part no. 1547 on page 53 for details



MOST WOODHEAD PRODUCTS HAVE U.L. AND/OR CSA APPROVALS. FOR A LISTING OF APPROVALS BY PART NUMBER, SEE PAGES 262-269.

# REELS

## INDUSTRIAL DUTY Cable Reels

Meets NEMA 4 rating for water and corrosion, weather- and dust-resistance. Compact, rugged and reliable cable reel, designed for safe, easy use and dependable long-term service. Cast aluminum construction in yellow powder coat finish. Cable guide is adjustable every 5 degrees over a 270 degree arc. Ratchet lock is easy to disengage for constant tension. Reel cannot be “locked out” at full extension. Large, easy access junction box and easily replaceable spring set this reel apart from others. Ball stops are available on page 197.

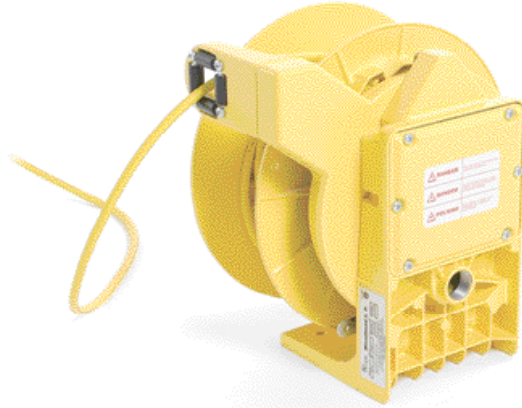

### Industrial Duty Cable Reels

SOW cable 600V rated. Lifting speed: 150 f.p.m. max. Retraction weight: 4 lbs. Collector ring rating: 30A.

| WIRE GAUGE | COND. | AMPS <sup>1</sup> | CABLE LENGTH |      |       |      |      |       |      |       | WITHOUT CABLE |             |
|------------|-------|-------------------|--------------|------|-------|------|------|-------|------|-------|---------------|-------------|
|            |       |                   | 20'          | 25'  | 30'   | 35'  | 38'  | 40'   | 45'  | 50'   | PART NO.      | CABLE RANGE |
| 16 AWG     | 3     | 9A                | —            | —    | 9224  | —    | —    | —     | —    | 9228  | 095105203     | up to 50'   |
|            | 4     | 7A                | —            | —    | 9234  | —    | —    | —     | —    | 9238  | 095105204     | up to 50'   |
|            | 6     | 7A                | —            | —    | —     | —    | —    | —     | 9206 | —     | 095105206     | up to 50'   |
|            | 8     | 6A                | —            | —    | —     | —    | 9208 | —     | —    | —     | 095105208     | up to 38'   |
|            | 8     | 6A                | —            | —    | —     | —    | —    | —     | —    | 92481 | 095106208     | 38-50'      |
|            | 10    | 5A                | —            | —    | 92401 | —    | —    | —     | —    | —     | 095106210     | up to 40'   |
|            | 12    | 5A                | —            | —    | 92411 | —    | —    | —     | —    | —     | 095106212     | up to 40'   |
| 14 AWG     | 3     | 13A               | —            | 9253 | —     | —    | —    | —     | —    | —     | 095105203     | up to 25'   |
|            | 3     | 13A               | —            | —    | —     | —    | —    | —     | —    | 9358  | 095104203     | 25-50'      |
|            | 4     | 11A               | —            | 9363 | —     | —    | —    | —     | 9367 | —     | 095104204     | up to 50'   |
|            | 6     | 11A               | —            | —    | —     | 9306 | —    | —     | —    | —     | 095104206     | up to 40'   |
|            | 8     | 8A                | 9308         | —    | —     | —    | —    | —     | —    | —     | 095104208     | up to 20'   |
|            | 8     | 8A                | —            | —    | 92482 | —    | —    | —     | —    | —     | 095106208     | 20-30'      |
|            | 10    | 7A                | 92402        | —    | —     | —    | —    | —     | —    | —     | 095106210     | up to 20'   |
| 12 AWG     | 3     | 18A               | —            | 9383 | —     | 9385 | —    | —     | —    | —     | 095104203     | up to 35'   |
|            | 3     | 18A               | —            | —    | —     | —    | —    | —     | —    | 92433 | 095106203     | 35-50'      |
|            | 4     | 14A               | —            | —    | 9394  | —    | —    | —     | —    | —     | 095104204     | up to 30'   |
|            | 4     | 14A               | —            | —    | —     | —    | —    | 92443 | —    | —     | 095106204     | 30-40'      |
|            | 6     | 14A               | —            | —    | 92463 | —    | —    | —     | —    | —     | 095106206     | up to 30'   |
|            | 8     | 12A               | 92483        | —    | —     | —    | —    | —     | —    | —     | 095106208     | up to 20'   |
| 10 AWG     | 3     | 22A               | 9242         | —    | —     | —    | —    | —     | —    | —     | 095105203     | up to 30'   |
|            | 3     | 22A               | —            | —    | —     | —    | —    | 92434 | —    | —     | 095106203     | 30-40'      |
|            | 4     | 16A               | —            | —    | 92444 | —    | —    | —     | —    | —     | 095106204     | up to 30'   |
|            | 6     | 14A               | 92464        | —    | —     | —    | —    | —     | —    | —     | 095106206     | up to 20'   |

<sup>1</sup> THE CORD REEL AMPERAGE RATINGS LISTED ARE DE-RATED FIGURES. THEY ARE BASED ON THE CABLE BEING SPOOLED AND RUN AT FULL LOAD. THE RATINGS SUPPLIED BY CABLE MANUFACTURERS ARE WITH THE CABLE FULLY EXTENDED IN FREE AIR. FOR MORE COMPLETE DATA OR SPECIFIC DETAILS, PLEASE REFER TO THE NATIONAL ELECTRICAL CODE.

NOTE: FOR TECHNICAL INFORMATION SEE PAGES 204-205.



MOST WOODHEAD PRODUCTS HAVE U.L. AND/OR CSA APPROVALS.  
FOR A LISTING OF APPROVALS BY PART NUMBER, SEE PAGES 262-269.

**INDUSTRIAL DUTY** Cable Reels with Accessories

Cable Reels with 13W Fluorescent Hand Lamp

| WITH REEL NO.   | CORD TYPE | CORD LENGTH | PART NO. |         |
|---|-----------|-------------|----------|---------|
|  | 9228      | 16/3 SOW    | 50'      | 9228-86 |
|   | 9224      | 16/3 SOW    | 30'      | 9224-86 |

**Hand Lamp Features**

- rubber handle with butyrate tube guard
- on/off switch on handle
- ballast in handle
- bulb included
- insulated light (non-conductive)
- see part no. 1086-3 on page 16 for details



Cable Reels with 100W Max Incandescent Hand Lamp w/ Power Switch

| WITH REEL NO.   | CORD TYPE | CORD LENGTH | PART NO. |            |
|---|-----------|-------------|----------|------------|
|  | 9228      | 16/3 SOW    | 50'      | 9228-106US |
|   | 9358      | 14/3 SOW    | 50'      | 9358-106US |
|   | 9224      | 16/3 SOW    | 30'      | 9224-106US |
|   | 9253      | 14/3 SOW    | 25'      | 9253-106US |

**Hand Lamp Features**

- rubber handle with metal guard
- on/off switch on handle
- side outlet on handle
- see part no. 106US on page 14 for details



Cable Reels with 75W Incandescent Low Volt Hand Lamp w/ Glass Globe

| WITH REEL NO.   | CORD TYPE | CORD LENGTH | PART NO. |           |
|---|-----------|-------------|----------|-----------|
|  | 9228      | 16/3 SOW    | 50'      | 9228-1621 |
|   | 9358      | 14/3 SOW    | 50'      | 9358-1621 |
|   | 9224      | 16/3 SOW    | 30'      | 9224-1621 |
|   | 9253      | 14/3 SOW    | 25'      | 9253-1621 |

**Hand Lamp Features**

- rubber handle with tempered glass globe and wire guard
- transformer located on primary side of reel
- see part no. 1621-12A on page 10 for details



 MOST WOODHEAD PRODUCTS HAVE U.L. AND/OR CSA APPROVALS. FOR A LISTING OF APPROVALS BY PART NUMBER, SEE PAGES 262-269.

## REELS

### INDUSTRIAL DUTY Cable Reels with Accessories

#### Cable Reels with 30W Max Low Volt Incandescent Spot Light

| WITH REEL NO.  | CORD TYPE | CORD LENGTH | PART NO.   |
|--|-----------|-------------|------------|
|  9228 | 16/3 SOW  | 50'         | 9228-1610S |
| 9358   | 14/3 SOW  | 50'         | 9358-1610S |
| 9224   | 16/3 SOW  | 30'         | 9224-1610S |
| 9253   | 14/3 SOW  | 25'         | 9253-1610S |

#### Spot Light Features

- rubber handle with metal guard
- on/off switch on handle
- insulated light (non-conductive)
- 125V to 12V transformer located on primary side of reel
- see part no. 1610S on page 41 for details



#### Cable Reels with 15A Pendant Outlet Box

| WITH REEL NO.   | CORD TYPE | CORD LENGTH | PART NO.   |
|---|-----------|-------------|------------|
|  9358 | 14/3 SOW  | 50'         | 9358-3000  |
| 92433   | 12/3 SOW  | 50'         | 92433-3000 |
| 9253  | 14/3 SOW  | 25'         | 9253-3000  |
| 9383  | 12/3 SOW  | 25'         | 9383-3000  |

#### 15A Outlet Box Features

- two duplex, NEMA 5-15 outlets
- standard depth box – 3 $\frac{3}{8}$ "
- see part no. 3000-1 on page 140 for details

#### 20A Outlet Box Features

- two duplex, NEMA 5-20 outlets
- extended depth box – 4 $\frac{3}{8}$ "
- see part no. 3080-10 on page 140 for details

#### Cable Reels with 20A Pendant Outlet Box

| WITH REEL NO.   | CORD TYPE | CORD LENGTH | PART NO.   |
|---|-----------|-------------|------------|
|  92433 | 12/3 SOW  | 50'         | 92433-3080 |
| 9383  | 12/3 SOW  | 25'         | 9383-3080  |



MOST WOODHEAD PRODUCTS HAVE U.L. AND/OR CSA APPROVALS.  
FOR A LISTING OF APPROVALS BY PART NUMBER, SEE PAGES 262-269.

## INDUSTRIAL DUTY Cable Reels with Accessories

### Cable Reels with 15A GFCI Pendant Outlet Box

| WITH REEL NO.  | CORD TYPE | CORD LENGTH | PART NO.    |
|--|-----------|-------------|-------------|
|  9358 | 14/3 SOW  | 50'         | 9358-3070G  |
| 92433  | 12/3 SOW  | 50'         | 92433-3070G |
| 9253   | 14/3 SOW  | 25'         | 9253-3070G  |
| 9383   | 12/3 SOW  | 25'         | 9383-3070G  |

#### Outlet Box Features

- GFCI duplex, NEMA 5-15
- extended depth box – 4 $\frac{3}{8}$ "
- see part no. 3070-GFI on page 136 for details



### Cable Reels with 15A Connector

| WITH REEL NO.  | CORD TYPE | CORD LENGTH | PART NO.   |
|--|-----------|-------------|------------|
|  9228 | 16/3 SOW  | 50'         | 9228-1547  |
| 9358   | 14/3 SOW  | 50'         | 9358-1547  |
| 92433  | 12/3 SOW  | 50'         | 92433-1547 |
| 9224   | 16/3 SOW  | 30'         | 9224-1547  |
| 9253   | 14/3 SOW  | 25'         | 9253-1547  |
| 9383   | 12/3 SOW  | 25'         | 9383-1547  |

#### 15A Connector Features

- NEMA 5-15 15A/125V 2-pole, 3-wire
- see part no. 1547 on page 53 for details

#### 20A Connector Features

- NEMA 5-20 20A/125V 2-pole, 3-wire
- see part no. 1533 on page 73 for details

### Cable Reels with 20A Connector

| WITH REEL NO.   | CORD TYPE | CORD LENGTH | PART NO.   |
|---|-----------|-------------|------------|
|  92433 | 12/3 SOW  | 50'         | 92433-1533 |
| 9383  | 12/3 SOW  | 25'         | 9383-1533  |



### Ball Stop Assemblies

| CABLE DIAMETER (INCHES) | PART NO. |
|-------------------------|----------|
| UP TO 0.750"            | 9521     |
| 0.750" - 0.875"         | 9522     |
| 0.875" - 1.200"         | 9523     |



MOST WOODHEAD PRODUCTS HAVE U.L. AND/OR CSA APPROVALS.  
FOR A LISTING OF APPROVALS BY PART NUMBER, SEE PAGES 262-269.



# REELS

## HEAVY DUTY Cable Reels 20-70 ft., retraction weight 4 lbs.

Weather- and dust-resistant enclosure meets NEMA 4 rating for outdoor use. Rugged Steel construction in a compact design. Quick change spring motor, long life containerized guide. Steel flange and stand, bronze ball bearings. Ratchet lock may be disengaged for constant tension, direct spring drive, maximum lifting speed of 150 f.p.m. Retraction weight: 4 lbs. 600V rated SOW cable. Collector ring rating is 35A for AWG sizes 10-16. Collector ring rating is 75A for AWG sizes 6 and 8. Guide arm can be adjusted in 5° increments. Ball stops are available on page 197.



### Heavy Duty Cable Reels

| WIRE GAUGE | COND. | AMPS <sup>1</sup> | CABLE LENGTH (PART NO. / LENGTH) |         |         |         |        |         | WITHOUT CABLE  |             |
|------------|-------|-------------------|----------------------------------|---------|---------|---------|--------|---------|----------------|-------------|
|            |       |                   | 20'                              | 30'     | 40'     | 50'     | 60'    | 70'     | PART NO.       | CABLE RANGE |
| 16 AWG     | 3     | 10A               | —                                | —       | —       | —       | —      | 92531N  | 10511303G0L000 | up to 70'   |
|            | 4     | 8A                | —                                | —       | —       | —       | —      | 92541N  | 10511304G0L000 | up to 70'   |
|            | 6     | 8A                | —                                | —       | —       | —       | —      | 92561N  | 10511306G0L000 | up to 70'   |
|            | 8     | 7A                | —                                | —       | —       | —       | —      | 92581N  | 10511308G0L000 | up to 70'   |
|            | 10    | 5A                | —                                | —       | —       | 92501AN | —      | —       | 10511310G0L000 | up to 50'   |
| 14 AWG     | 12    | 5A                | —                                | —       | —       | 92511AN | —      | —       | 10511312G0L000 | up to 50'   |
|            | 3     | 15A               | —                                | —       | —       | —       | —      | 92532N  | 10511303G0L000 | up to 70'   |
|            | 4     | 12A               | —                                | —       | —       | —       | —      | 92542N  | 10511304G0L000 | up to 70'   |
|            | 6     | 12A               | —                                | —       | —       | 92562AN | —      | —       | 10511306G0L000 | up to 50'   |
|            | 6     | 12A               | —                                | —       | —       | —       | —      | 92562BN | 10512306G0L000 | 50-70'      |
|            | 8     | 10A               | —                                | —       | —       | —       | 92582N | —       | 10512308G0L000 | up to 60'   |
|            | 10    | 7A                | —                                | —       | —       | 92502N  | —      | —       | 10512310G0L000 | up to 50'   |
|            | 12    | 7A                | 92512AN                          | —       | —       | —       | —      | —       | 10511312G0L000 | up to 30'   |
| 12 AWG     | 12    | 7A                | —                                | —       | 92512BN | —       | —      | —       | 10512312G0L000 | 30-40'      |
|            | 3     | 20A               | —                                | —       | —       | —       | —      | 92533N  | 10511303G0L000 | up to 70'   |
|            | 4     | 16A               | —                                | —       | —       | —       | 92543N | —       | 10511304G0L000 | up to 60'   |
|            | 6     | 14A               | —                                | —       | —       | —       | 92663  | —       | 10512306G0L000 | up to 60'   |
|            | 8     | 14A               | —                                | —       | —       | 92583N  | —      | —       | 10512308G0L000 | up to 50'   |
| 10 AWG     | 3     | 25A               | —                                | —       | —       | —       | —      | 92534N  | 10512303G0L000 | up to 70'   |
|            | 4     | 20A               | —                                | —       | —       | 92544AN | —      | 92544BN | 10512304G0L000 | up to 70'   |
|            | 6     | 20A               | —                                | —       | —       | 92564N  | —      | —       | 10513306G0L000 | up to 50'   |
|            | 8     | 14A               | —                                | 92584N  | —       | —       | —      | —       | 10512308G0L000 | up to 30'   |
| 8 AWG      | 2     | 35A               | —                                | —       | —       | —       | —      | —       | 1051140200L000 | up to 40'   |
|            | 2     | 35A               | —                                | —       | —       | —       | —      | —       | 1051240200L000 | 40-50'      |
|            | 3     | 35A               | —                                | 92535AN | —       | —       | —      | —       | 10511403G0L000 | up to 30'   |
|            | 3     | 35A               | —                                | —       | —       | 92535BN | —      | —       | 10512403G0L000 | 30-50'      |
|            | 4     | 28A               | —                                | 92545AN | —       | —       | —      | —       | 10511404G0L000 | up to 20'   |
|            | 4     | 28A               | —                                | —       | —       | 92545AN | —      | —       | 10513404G0L000 | 30-40'      |
| 6 AWG      | 2     | 45A               | —                                | 92526AN | —       | —       | —      | —       | 1051240200L000 | up to 40'   |
|            | 2     | 45A               | —                                | —       | —       | 92526BN | —      | —       | 1051340200L000 | 40-50'      |
|            | 3     | 45A               | —                                | 92536N  | —       | —       | —      | —       | 10513403G0L000 | up to 30'   |
|            | 4     | 36A               | 92546N                           | —       | —       | —       | —      | —       | 10513404G0L000 | up to 30'   |

<sup>1</sup> THE CORD REEL AMPERAGE RATINGS LISTED ARE DE-RATED FIGURES. THEY ARE BASED ON THE CABLE BEING SPOOLED AND RUN AT FULL LOAD. THE RATINGS SUPPLIED BY CABLE MANUFACTURERS ARE WITH THE CABLE FULLY EXTENDED IN FREE AIR. FOR MORE COMPLETE DATA OR SPECIFIC DETAILS, PLEASE REFER TO THE NATIONAL ELECTRICAL CODE.

UL SP MOST WOODHEAD PRODUCTS HAVE U.L. AND/OR CSA APPROVALS. FOR A LISTING OF APPROVALS BY PART NUMBER, SEE PAGES 262-269.

**HEAVY DUTY** Cable Reels 40-160 ft., retraction weight 7 lbs.

Rugged steel construction in a compact design. Weather- and dust-resistant enclosure meets NEMA 4 rating for outdoor use. Quick change spring motor, long-life containerized main-spring, declutching drive hub, lifetime lubrication. Steel flange stand, bronze ball bearings. Ratchet lock can be disengaged for constant tension. Direct drive with lifting speed of 150 f.p.m. Retraction weight: 7 lbs. 600V rated SOW cable. Collector ring rating is 35A for AWG sizes 10-16. Collector ring rating is 75A for AWG sizes 6 and 8. Ball stops are available on page 197.



Heavy Duty Cable Reels

| WIRE GAUGE | COND. | AMPS <sup>1</sup> | CABLE LENGTH (PART NO. / LENGTH) |              |              | WITHOUT CABLE             |             |
|------------|-------|-------------------|----------------------------------|--------------|--------------|---------------------------|-------------|
|            |       |                   | 40-65'                           | 80-110'      | 115-160'     | PART NO.                  | CABLE RANGE |
| 16 AWG     | 3     | 9A                | —                                | —            | 92631 / 115' | 114310303G0L <sup>2</sup> | up to 115'  |
|            | 4     | 7A                | —                                | —            | 92641 / 115' | 114310304G0L <sup>2</sup> | up to 115'  |
|            | 6     | 7A                | —                                | 92661 / 100' | —            | 114310306G1L              | up to 100'  |
|            | 6     | 7A                | —                                | —            | 92761 / 150' | 116505306G1L              | 100-150'    |
|            | 8     | 6A                | —                                | 92681 / 95'  | —            | 114310308G1L              | up to 95'   |
|            | 8     | 6A                | —                                | —            | 92781 / 150' | 116505308G1L              | 95-150'     |
| 14 AWG     | 3     | 13A               | —                                | 92632 / 110' | —            | 114310303G1L              | up to 110'  |
|            | 3     | 13A               | —                                | —            | 92732 / 160' | 116505303G1L              | 110-160'    |
|            | 4     | 11A               | —                                | 92642 / 110' | —            | 114310304G1L              | up to 110'  |
|            | 4     | 11A               | —                                | —            | 92742 / 160' | 116505304G1L              | 110-160'    |
|            | 6     | 11A               | —                                | —            | 92762 / 115' | 116505306G2L              | up to 115'  |
|            | 8     | 8A                | —                                | 92782 / 90'  | —            | 116505308G2L              | up to 90'   |
|            | 10    | 7A                | 92702 / 60'                      | —            | —            | 116505310G3L              | up to 60'   |
|            | 12    | 6A                | 92712 / 60'                      | —            | —            | 116505312G3L              | up to 60'   |
| 12 AWG     | 3     | 18A               | —                                | 92633 / 95'  | —            | 114310303G1L              | up to 95'   |
|            | 3     | 18A               | —                                | —            | 92733 / 160' | 116505303G1L              | 95-160'     |
|            | 4     | 14A               | —                                | 92643 / 80'  | —            | 114310304G2L              | up to 80'   |
|            | 4     | 14A               | —                                | —            | 92743 / 140' | 116505304G2L              | 80-140'     |
|            | 6     | 14A               | —                                | 92763 / 95'  | —            | 116505306G2L              | up to 95'   |
|            | 8     | 12A               | 92783 / 60'                      | —            | —            | 116505308G3L              | up to 60'   |
| 10 AWG     | 3     | 22A               | —                                | —            | 92734 / 130' | 116505303G2L              | up to 130'  |
|            | 4     | 16A               | —                                | —            | 92744 / 120' | 116505304G2L              | up to 120'  |
|            | 6     | 14A               | —                                | 92764 / 85'  | —            | 116505306G3L              | up to 85'   |
|            | 8     | 14A               | 92784 / 50'                      | —            | —            | 116505308G4L              | up to 50'   |
| 8 AWG      | 2     | 40A               | 92625 / 60'                      | —            | —            | 114310402J3L              | up to 60'   |
|            | 2     | 40A               | —                                | 92725 / 95'  | —            | 116505402J3L              | 60-95'      |
|            | 3     | 35A               | —                                | 92735 / 85'  | —            | 116505403G4L              | up to 85'   |
|            | 4     | 32A               | 92745 / 60'                      | —            | —            | 116505404G5L              | up to 60'   |
| 6 AWG      | 2     | 55A               | 92726 / 65'                      | —            | —            | 116505402J4L              | up to 65'   |
|            | 3     | 45A               | 92736 / 50'                      | —            | —            | 116505403G5L              | up to 50'   |
|            | 4     | 44A               | 92746 / 40'                      | —            | —            | 116505404G6L              | up to 40'   |

<sup>1</sup> THE CORD REEL AMPERAGE RATINGS LISTED ARE DE-RATED FIGURES. THEY ARE BASED ON THE CABLE BEING SPOOLED AND RUN AT FULL LOAD. THE RATINGS SUPPLIED BY CABLE MANUFACTURERS ARE WITH THE CABLE FULLY EXTENDED IN FREE AIR. FOR MORE COMPLETE DATA OR SPECIFIC DETAILS, PLEASE REFER TO THE NATIONAL ELECTRICAL CODE.

<sup>2</sup> CAN BE USED FOR RECOVERY APPLICATIONS.

NOTE: IT IS STRONGLY RECOMMENDED THAT A SECONDARY SAFETY CABLE OR CHAIN BE ATTACHED TO ALL REELS MOUNTED OVERHEAD TO PREVENT THE POSSIBILITY OF REELS ACCIDENTALLY FALLING.



MOST WOODHEAD PRODUCTS HAVE U.L. AND/OR CSA APPROVALS. FOR A LISTING OF APPROVALS BY PART NUMBER, SEE PAGES 262-269.

# REELS

## HAND WIND REELS

Hand wind reels are designed for heavy duty industrial storage applications. Perfect for storing extension cords, or for continuous power service. Capable of storing 200 ft. of 16/3, 125 ft. of 14/3 or 100 ft. of 12/3 SOW cord.

### Cable Reel

Heavy duty design for storage of extension cords, power cables, rope, or hoses.

| MAXIMUM SIZE<br>SOW CABLE | RATING WITH<br>CABLE UNWOUND | PART NO.      |          |           |
|---------------------------|------------------------------|---------------|----------|-----------|
|                           |                              | WITHOUT CABLE | WITH 50' | WITH 100' |
| 16/3                      | 10A 125V                     | 930           | 930B163  | 930D163   |
| 14/3                      | 15A 125V                     | 930           | 930B143  | 930D143   |
| 12/3                      | 15A 125V                     | 930           | 930B123  | 930D123   |



930 SERIES CABLE REEL

### Reel with Duplex Receptacle

- Features 15 amp, NEMA 5-15 duplex receptacle on reel and plug on free end of cable.
- Point of use
- Disconnecting electrical device is required to wind or unwind cable.

| MAXIMUM SIZE<br>SOW CABLE | RATING WITH<br>CABLE UNWOUND | PART NO.      |          |           |
|---------------------------|------------------------------|---------------|----------|-----------|
|                           |                              | WITHOUT CABLE | WITH 50' | WITH 100' |
| 16/3                      | 10A 125V                     | 931           | 931B163  | 931D163   |
| 14/3                      | 15A 125V                     | 931           | 931B143  | 931D143   |
| 12/3                      | 15A 125V                     | 931           | 931B123  | 931D123   |

### Reel with Three Conductor Slip Ring

- Equipped with slip ring, power cable, and plug.
- Ideal for continuous service.

| MAXIMUM SIZE<br>SOW CABLE | RATING WITH<br>CABLE UNWOUND | PART NO.      |          |           |
|---------------------------|------------------------------|---------------|----------|-----------|
|                           |                              | WITHOUT CABLE | WITH 50' | WITH 100' |
| 16/3                      | 10A 125V                     | 932           | 932B163  | 932D163   |
| 14/3                      | 15A 125V                     | 932           | 932B143  | 932D143   |
| 12/3                      | 15A 125V                     | 932           | 932B123  | 932D123   |

NOTE: MAXIMUM CAPACITIES FOR ALL MODELS

#16 AWG SOW, 3 CONDUCTOR (.430 IN. DIA.) – 200 FT.

#14 AWG SOW, 3 CONDUCTOR (.560 IN. DIA.) – 125 FT.

#12 AWG SOW, 3 CONDUCTOR (.640 IN. DIA.) – 100 FT.

## BEST SELLER!

### Static Ground Reel

- galvanized steel
- 25 ft. cable

part no. 143025  
see page 216



### Anti-Static Ground Reel

Steel construction and instant-acting lock-and-release mean durability and ease of use. Supplied galvanized steel aviation cable is 3/32" dia. Equipped with 100 amp ground clamp and rubber bumper. Cable resistance is one ohm through entire unit.

UL SP MOST WOODHEAD PRODUCTS HAVE U.L. AND/OR CSA APPROVALS.  
FOR A LISTING OF APPROVALS BY PART NUMBER, SEE PAGES 262-269.

**HAND WIND REELS**

Steel rod frame and handle with wide base. Heavy gauge steel flanges. No collector rings, brushes or slip rings. Large rewinding knob. Available with or without receptacles, spring loaded flip lids, or a lead cord. Capable of storing up to 150 ft. of 12/3 or 200 ft. of 14/3 SOW cord. Disconnecting electrical device is required to wind or unwind the cable. Reels with cord have plug on free end of cable (except for 915 series).



910/911/916 SERIES CABLE REEL

**Cable Reels with Receptacles**

Features four receptacles and a plug on free end of cable. Available with GFCI protection.

| RECEPTACLE RATING | RECEPTACLE CONFIGURATION | NUMBER OF RECEPTACLES | GFCI PROTECTION | PART NO.      |                      |                      |
|-------------------|--------------------------|-----------------------|-----------------|---------------|----------------------|----------------------|
|                   |                          |                       |                 | WITHOUT CABLE | WITH 12/3 SOW        | WITH 14/3 SOW        |
| 15A 125V          | NEMA 5-15                | 4                     | NO              | 910           | 910_123 <sup>1</sup> | 910_143 <sup>2</sup> |
| 15A 125V          | NEMA L5-15               | 4                     | NO              | 911           | 911_123 <sup>1</sup> | 911_143 <sup>2</sup> |
| 15A 125V          | NEMA 5-15                | 4                     | YES             | 916           | 916_123 <sup>1</sup> | 916_143 <sup>2</sup> |

**Cable Reels with Covered Receptacles**

Features two receptacles with weather resistant, spring-loaded flip lids and a plug on free end of cable (920 series does not include receptacles).

| RECEPTACLE RATING | RECEPTACLE CONFIGURATION | NUMBER OF RECEPTACLES | GFCI PROTECTION | PART NO.      |                      |                      |
|-------------------|--------------------------|-----------------------|-----------------|---------------|----------------------|----------------------|
|                   |                          |                       |                 | WITHOUT CABLE | WITH 12/3 SOW        | WITH 14/3 SOW        |
| 20A 250V          | NEMA L2-20               | 2                     | NO              | 912           | 912_122 <sup>1</sup> | 912_142 <sup>2</sup> |
| 20A 125V/250V     | NON-NEMA LOCKING         | 2                     | NO              | 913           | 913_123 <sup>1</sup> | 913_143 <sup>2</sup> |
| 20A 125V          | NEMA L5-20               | 2                     | NO              | 914           | 914_123 <sup>1</sup> | 914_143 <sup>2</sup> |
| —                 | —                        | NONE                  | NO              | 920           | 920_123 <sup>1</sup> | 920_143 <sup>2</sup> |

**Cable Reels with Lead Cord, Plug, and Connector – No Receptacles**

| RECEPTACLE RATING | RECEPTACLE CONFIGURATION | NUMBER OF RECEPTACLES | GFCI PROTECTION | PART NO.      |                      |                      |
|-------------------|--------------------------|-----------------------|-----------------|---------------|----------------------|----------------------|
|                   |                          |                       |                 | WITHOUT CABLE | WITH 12/3 SOW        | WITH 14/3 SOW        |
| —                 | —                        | NONE                  | NO              | 915           | 915_123 <sup>1</sup> | 915_143 <sup>2</sup> |

<sup>1</sup> CABLE REELS WITH 12/3 SOW ONLY AVAILABLE WITH 100 FT. AND 150 FT. OF CABLE. USE MATRIX BELOW.  
<sup>2</sup> CABLE REELS WITH 14/3 SOW AVAILABLE WITH 100 FT., 150 FT. AND 200 FT. OF CABLE. USE MATRIX BELOW.

Cable Length: To select the length of primary cable for the outlet box, place one of the following letters in the space.

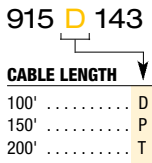

MOST WOODHEAD PRODUCTS HAVE U.L. AND/OR CSA APPROVALS. FOR A LISTING OF APPROVALS BY PART NUMBER, SEE PAGES 262-269.

# REELS

## FESTOONS Power Cable Carrying Systems

Festoon Power Cable Carrying Systems are ideal for powering horizontally moving hoists, small cranes and moving parts on machinery. Systems include end clamps, carriers, wire rope and hardware. Light and durable, each system is packaged in its own carrying/storage case.

Each system includes:

- Two clamp assemblies for end tie-off (No. 95110 for flat cable; No. 95120 for round cable).
- One hardware kit consisting of two eyebolts, five clamps and one ballstop.
- Carriers with clamp assemblies (No. 95111 for flat cable; No. 95121 for round cable).
- Required length of nylon-covered wire rope (.19 inch diameter).



### Determine Electrical Cable Length

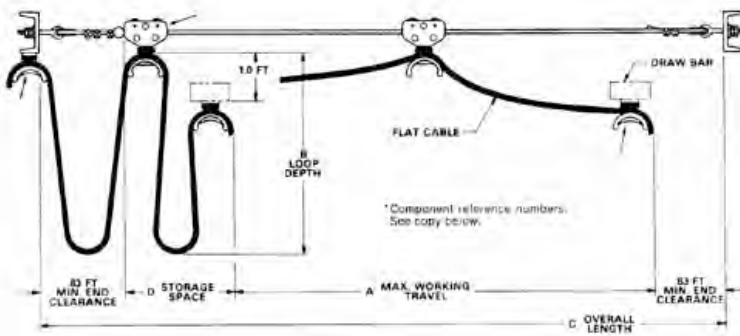

$$\text{Overall Length}^1 = \left( \text{Max. Working Travel (A)} + \text{Storage Space (D)} + \text{End Clearance (E+F)} \right) \times 1.1 + \text{Hookup (both ends)}$$

<sup>1</sup> IN FLAT CABLE SYSTEMS, LOOP CONFIGURATIONS ARE ROUNDED AND CLAMPS DIFFER IN APPEARANCE. SYSTEM DIMENSIONS AND REFERENCES ARE IDENTICAL FOR BOTH FESTOON SYSTEMS.

### How to Order Festoon Systems

| CABLE | MAX. TRAVEL DISTANCE |             | OVERALL SYSTEM LENGTH |             | STORAGE SPACE | NO. OF CARRIERS | PART NO. |
|-------|----------------------|-------------|-----------------------|-------------|---------------|-----------------|----------|
|       | W/ 4' LOOPS          | W/ 3' LOOPS | W/ 4' LOOPS           | W/ 3' LOOPS |               |                 |          |
| Round | 20'                  | 15'         | 22.5'                 | 17.5'       | 0.84'         | 2               | 95122    |
| Round | 35'                  | 26'         | 38.1'                 | 29.1'       | 1.40'         | 4               | 95124    |
| Round | 50'                  | 37'         | 53.7'                 | 40.7'       | 1.97'         | 6               | 95126    |
| Round | 65'                  | 48'         | 69.2'                 | 52.2'       | 2.53'         | 8               | 95128    |
| Flat  | 21'                  | 16'         | 23.7'                 | 18.7'       | 1.05'         | 2               | 95112    |
| Flat  | 36'                  | 27'         | 39.4'                 | 30.5'       | 1.75'         | 4               | 95114    |
| Flat  | 51'                  | 38'         | 55.1'                 | 42.2'       | 2.45'         | 6               | 95116    |
| Flat  | 66'                  | 50'         | 70.8'                 | 54.8'       | 3.15'         | 8               | 95118    |

NOTE: WEIGHT CAPACITY IS 9 LBS. PER CARRIER.



MOST WOODHEAD PRODUCTS HAVE U.L. AND/OR CSA APPROVALS. FOR A LISTING OF APPROVALS BY PART NUMBER, SEE PAGES 262-269.

FESTOONS System Components



FLAT CABLE CARRIER/  
CLAMP ASSEMBLY  
95111



FLAT CABLE CLAMP  
95110

Flat Cable Components

| DESCRIPTION                        | PART NO. |
|------------------------------------|----------|
| FLAT CABLE CARRIER/CLAMP ASSEMBLY  | 95111    |
| FLAT CABLE CLAMP ONLY <sup>1</sup> | 95110    |

<sup>1</sup> FOR TIE-OFF CLAMPING TO FIXED POINT OR DRAW BAR  
NOTE: MAXIMUM CABLE THICKNESS IS .30 IN (8 CM). WEIGHT CAPACITY IS 9 LBS PER CARRIER.



ROUND CABLE CARRIER/  
CLAMP ASSEMBLY  
95121



ROUND CABLE CLAMP  
95120

Round Cable Components

| DESCRIPTION                                     | PART NO. |
|---|----------|
| ROUND CABLE CARRIER/CLAMP ASSEMBLY <sup>2</sup> | 95121    |
| ROUND CABLE CLAMP ONLY <sup>3</sup>             | 95120    |

<sup>2</sup> TO PROVIDE A MULTIPLE CARRIER FOR ROUND CABLE, ADD A SECOND CLAMP (95120) TO THE UNIT.  
<sup>3</sup> FOR TIE-OFF OR DOUBLE TIER ARRANGEMENTS  
NOTE: CABLE RANGE FOR ROUND CABLE IS .49 IN (1.2 CM) TO .91 IN. (2.3 CM). WEIGHT CAPACITY IS 9 LBS. PER CARRIER.

 MOST WOODHEAD PRODUCTS HAVE U.L. AND/OR CSA APPROVALS.  
FOR A LISTING OF APPROVALS BY PART NUMBER, SEE PAGES 262-269.



## TECHNICAL REFERENCE

Watertite® is a registered trademark of Woodhead Industries, Inc. Woodhead Industrial Cable reels are designed for top performance, long life, and easy maintenance. Series 9200, 9300, and 92400 are perfect for mobile electrical equipment, portable lighting, or hand-held power tools, and can handle cord lengths up to 50ft. For longer cord lengths and heavier gauge cord, our 92500, 92600, and 92700 cord reels are available and are ideal for hoists, large electric tools, and moving equipment. All of our industrial reels are suitable for vertical lift, vertical recovery, and drag applications. We also have reels which have the correct spring tension for horizontal stretch and recovery applications. Where minimum cable sag is not critical, our industrial cord reels can be used for stretch service where an expected cable sag at mid-point of 10% is allowable.

## Applications

Cord reel applications include vertical lift, drag, horizontal stretch, recovery, and vertical recovery. Different applications require different variations in spring tension for optimal performance. Definition of cord reel applications are:

### Vertical Lift

Reel is mounted overhead. Cable pays out downward and is retracted up via spring power. Reel must have enough tension to lift the total weight of the cable and any additional weight attached to it, e.g., pendant station, cable overhang.

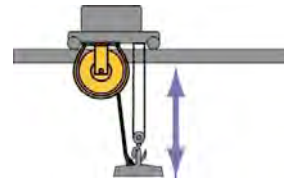

### Horizontal Stretch

Cable is suspended in the air, supported at both ends. The tension must accommodate about twice the total weight of the cable to maintain an acceptable 6% sag.

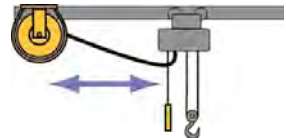

### Recovery

Mounted on a moving carrier, reel picks up cable from stationary base. The closer the reel is to the recovery surface, the less tension is required.

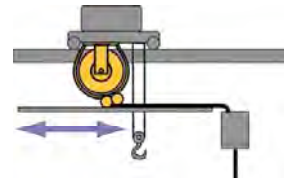

### Drag

The reel is mounted in a permanent location. Cable is dragged over surface to and from fixed mounted reel. The tension required is about the same as the lift application.

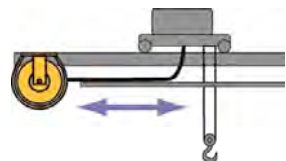

### Vertical Recovery

Base mounted reel pays out cable upward. The reel is required only to recover the cable on the spool, as the cable moves downward. Minimal tension is needed to recover cable into the reel.

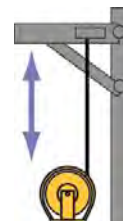

TECHNICAL REFERENCE

Reel Dimensions

STANDARD DUTY CORD REEL 980/990/997 WITH OPTIONAL SWING MOUNT

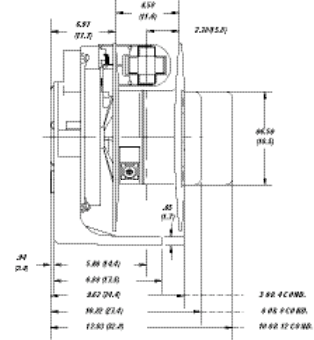
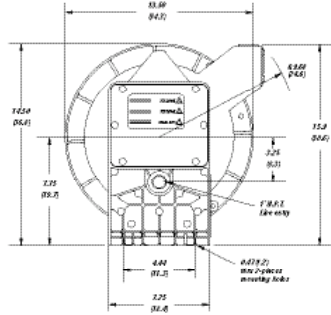

STANDARD DUTY CORD REEL 945-3

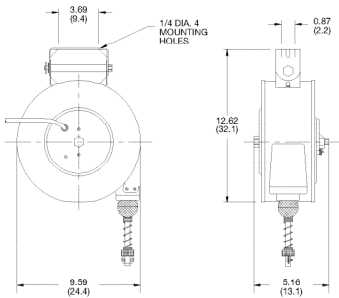

INDUSTRIAL DUTY CABLE REEL

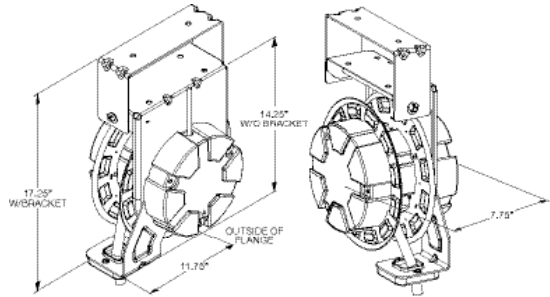

HEAVY DUTY CABLE REEL 20 – 70 FT.

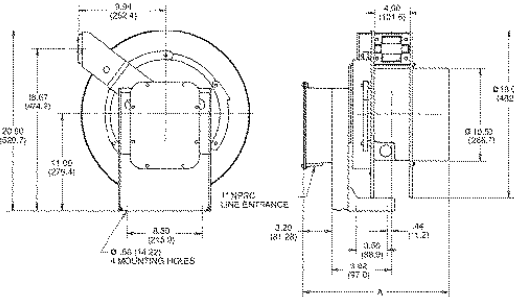

1000 Series Reel

| REEL WITHOUT CABLE NUMBER | DIMENSION A |     | WEIGHT (LBS.) |
|---------------------------|-------------|-----|---------------|
|                           | IN.         | MM  |               |
| 1051-xx-303               | 16.67       | 423 | 81            |
| 1051-xx-304               | 16.67       | 423 | 81            |
| 1051-xx-306               | 16.67       | 423 | 82            |
| 1051-xx-308               | 18.84       | 479 | 82            |
| 1051-xx-310               | 18.84       | 479 | 83            |
| 1051-xx-312               | 18.84       | 479 | 83            |
| 1051-xx-402               | 16.67       | 423 | 81            |
| 1051-xx-403               | 16.67       | 423 | 81            |
| 1051-xx-404               | 18.84       | 479 | 82            |

HEAVY DUTY CABLE REEL 40-160 FT.

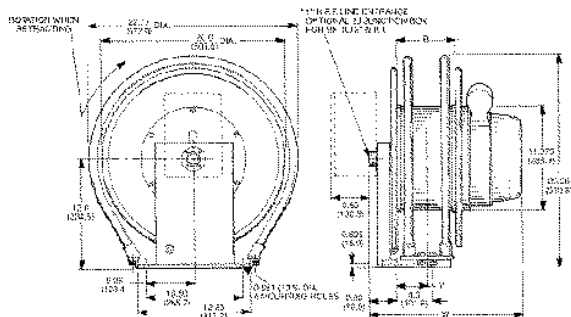

1100 Series Reel

| REEL WITHOUT CABLE NUMBER | DIMENSION W |       | WEIGHT (LBS.) |
|---------------------------|-------------|-------|---------------|
|                           | IN.         | MM    |               |
| 1143-xx-303               | 16.38       | 416.1 | 138           |
| 1143-xx-304               | 16.38       | 416.1 | 138           |
| 1143-xx-306               | 18.38       | 466.9 | 139           |
| 1143-xx-308               | 18.38       | 466.9 | 140           |
| 1143-xx-402               | 18.38       | 466.9 | 139           |
| 1165-xx-303               | 20.75       | 527.1 | 188           |
| 1165-xx-304               | 20.75       | 527.1 | 188           |
| 1165-xx-306               | 22.75       | 577.9 | 189           |
| 1165-xx-308               | 22.75       | 577.9 | 190           |
| 1165-xx-310               | 24.75       | 628.9 | 191           |
| 1165-xx-312               | 24.75       | 628.9 | 192           |
| 1165-xx-402               | 22.75       | 577.9 | 189           |
| 1165-xx-403               | 22.75       | 577.9 | 189           |
| 1165-xx-404               | 22.75       | 577.9 | 190           |

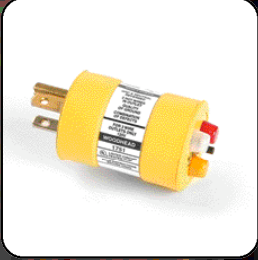

Long standing users of electrical products know the name to count on for dependable and durable electrical specialty products – Woodhead. Overhead, underfoot, in hand, everywhere from construction sites, to convention centers, our pushbuttons and test instruments are built for years of safe, reliable service.

### **Pushbutton Pendant Stations**

Pushbutton Pendants available from Woodhead include ergonomically-designed pendants, industrial-grade pendants and industrial-grade enclosures. Ergonomic versions feature a compact nylon construction. Industrial grade versions have a durable, NEOTEX® rubber construction for added durability. As an additional safety feature, all switches are shrouded or recessed to protect workers against accidental activation.

### **Test Instruments**

From basic verification of proper wiring, to multi-function testing, Woodhead offers a range of easy to use test instruments. All are designed in the Woodhead tradition for long, reliable service.

# PUSHBUTTON/TEST INSTRUMENTS

## SUPER-SAFEWAY® Pushbutton Pendant Stations

Super-Safeway pushbutton pendant stations feature NEOTEX® rubber construction with a tongue and groove coverplate which protects buttons from industrial elements with a molded rubber shroud. They support a number of applications with momentary switches for either single speed or two speed needs, normally open or normally closed while maintained switches can be purchased as an accessory or replacement part. Single speed uses are extended with the emergency stop option, and the switches can be wired as an electrical interlock. All Super-Safeway pushbutton pendants include a legend plate package, compression type cord grips, wire retainer at the screw terminals, and metal bracket for messenger cord. Wire mesh grips for added strain relief are ordered separately.

### Switch Ratings

|                      |
|----------------------|
| <b>Single speed</b>  |
| 20A @ 125 TO 250VAC  |
| 25A @ 24VDC          |
| 0.5A @ 250VDC        |
| 1 HP @ 125VAC        |
| 2 HP @ 250VAC        |
| <b>Two speed</b>     |
| 10A @ 125 OR 250VAC  |
| 1/3 HP @ 125V        |
| 1/2 HP @ 250V        |
| <b>Maintain</b>      |
| 16A @ 125VAC         |
| 8A @ 250VAC          |
| 1 HP @ 125 OR 250VAC |

### BEST SELLERS!

#### 4-Button Station

- 0.500-0.750" cord diameter range
- single speed

part no. 4024

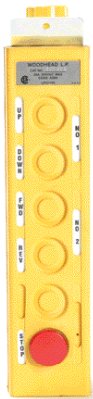

#### 6-Button Station

- with e-stop

part no. 4026ES

### Pushbutton Pendant Stations

| PART NO. | NUMBER OF BUTTONS | SPEED  | E-STOP | CORD GRIP |              | CORD DIA. RANGE |
|----------|-------------------|--------|--------|-----------|--------------|-----------------|
|          |                   |        |        | SIZE      | NUT          |                 |
| 4022     | 2                 | SINGLE |        | F3        | NON-METALLIC | 0.500-0.687"    |
| 4022-2   | 2                 | TWO    |        | F3        | NON-METALLIC | 0.500-0.687"    |
| 4022ES   | 2                 | SINGLE | ●      | F3        | NON-METALLIC | 0.500-0.687"    |
| 4023     | 3                 | SINGLE |        | F3        | NON-METALLIC | 0.500-0.750"    |
| 4023-2   | 3                 | TWO    |        | F3        | NON-METALLIC | 0.500-0.750"    |
| 4023ES   | 3                 | SINGLE | ●      | F3        | NON-METALLIC | 0.500-0.750"    |
| 4024     | 4                 | SINGLE |        | F3        | NON-METALLIC | 0.500-0.750"    |
| 4024-2   | 4                 | TWO    |        | F3        | NON-METALLIC | 0.500-0.750"    |
| 4024ES   | 4                 | SINGLE | ●      | F3        | NON-METALLIC | 0.500-0.750"    |
| 4026     | 6                 | SINGLE |        | F3        | NON-METALLIC | 0.562-0.812"    |
| 4026-2   | 6                 | TWO    |        | F3        | NON-METALLIC | 0.562-0.812"    |
| 4026ES   | 6                 | SINGLE | ●      | F4        | METAL        | 0.687-0.937"    |
| 4028     | 8                 | SINGLE |        | F4        | METAL        | 0.687-0.937"    |
| 4028-2   | 8                 | TWO    |        | F4        | METAL        | 0.687-0.937"    |
| 4028ES   | 8                 | SINGLE | ●      | F3        | NON-METALLIC | 0.562-0.812"    |



MOST WOODHEAD PRODUCTS HAVE U.L. AND/OR CSA APPROVALS. FOR A LISTING OF APPROVALS BY PART NUMBER, SEE PAGES 262-269.

## SUPER-SAFEWAY® Pushbutton Pendant Stations Accessories

A full range of accessories are available for pushbutton pendant stations. Wire mesh grip kits are ideal for providing the strain-relief needed to protect cords from the stress exerted on conductors entering the pushbutton enclosure. Replacement gaskets help maintain the wet location seal between the coverplate and the enclosure, while a full array of switches provide the flexibility required for various pendant station applications.

### Wire Mesh Grip Kits for Pendant Stations

| PART NO. | NUT      | MESH            | SIZE | CORD DIA. RANGE |
|----------|----------|-----------------|------|-----------------|
| 5633M    | PLASTIC  | STAINLESS STEEL | F3   | 0.437-0.500"    |
| 5633NM   | PLASTIC  | NON-METALLIC    | F3   | 0.437-0.500"    |
| 5634M    | PLASTIC  | STAINLESS STEEL | F3   | 0.500-0.625"    |
| 5634NM   | PLASTIC  | NON-METALLIC    | F3   | 0.500-0.625"    |
| 5635M    | PLASTIC  | STAINLESS STEEL | F3   | 0.562-0.687"    |
| 5635NM   | PLASTIC  | NON-METALLIC    | F3   | 0.562-0.687"    |
| 5636M    | PLASTIC  | STAINLESS STEEL | F4   | 0.562-0.687"    |
| 5636NM   | PLASTIC  | NON-METALLIC    | F4   | 0.562-0.687"    |
| 5637M    | PLASTIC  | STAINLESS STEEL | F4   | 0.625-0.750"    |
| 5637NM   | PLASTIC  | NON-METALLIC    | F4   | 0.625-0.750"    |
| 5638M    | PLASTIC  | STAINLESS STEEL | F4   | 0.750-0.875"    |
| 5638NM   | PLASTIC  | NON-METALLIC    | F4   | 0.750-0.875"    |
| 5639M    | PLASTIC  | STAINLESS STEEL | F4   | 0.875-1.000"    |
| 5639NM   | PLASTIC  | NON-METALLIC    | F4   | 0.875-1.000"    |
| 42-2040  | ALUMINUM | STAINLESS STEEL | F3   | 0.500-0.625"    |
| 42-2060  | ALUMINUM | STAINLESS STEEL | F3   | 0.625-0.750"    |
| 42-2080  | ALUMINUM | STAINLESS STEEL | F4   | 0.500-0.625"    |
| 42-2090  | ALUMINUM | STAINLESS STEEL | F4   | 0.625-0.750"    |
| 42-2110  | ALUMINUM | STAINLESS STEEL | F4   | 0.750-0.875"    |
| 42-2130  | ALUMINUM | STAINLESS STEEL | F4   | 0.875-1.000"    |

### Replacement Gaskets Kits

| PART NO. | DESCRIPTION                        |
|----------|------------------------------------|
| 4022G    | 2 BUTTON PUSHBUTTON STATION (4022) |
| 4023G    | 3 BUTTON PUSHBUTTON STATION (4023) |
| 4024G    | 4 BUTTON PUSHBUTTON STATION (4024) |
| 4026G    | 6 BUTTON PUSHBUTTON STATION (4026) |
| 4028G    | 8 BUTTON PUSHBUTTON STATION (4028) |

### Replacement Parts

| PART NO. | DESCRIPTION                               |
|----------|---|
| 71-4220  | LEGEND KIT                                |
| 4020     | SWITCH – ONE SPEED, MOMENTARY SWITCH      |
| 4020-2   | SWITCH – TWO SPEED, MOMENTARY SWITCH      |
| 37-0901  | MAINTAINED SWITCH WITH BRACKET            |
| 37-0360  | MAINTAINED PUSH/PULL NO/NC E-STOP         |
| 37-0361  | MAINTAINED PUSH/PULL (2) NC E-STOP        |
| 37-0362  | MAINTAINED TOGGLE NO/NC E-STOP            |
| 37-0363  | MOMENT PUSH/PULL NC E-STOP                |
| 37-0364  | MAINTAINED SELECTOR (2) POSITION          |
| 37-0365  | MOMENT PUSH/PULL MAINTAINED PUSH/PULL (2) |
| 37-0366  | MAINTAINED KEY OPERATED (2) POSITION      |
| 37-0367  | MAINTAINED TOGGLE                         |
| 37-0368  | MAINTAINED TOGGLE (3) POSITION            |

### BEST SELLERS!

#### Stainless Steel Mesh Grip Kit

- F3 cord grip
- plastic nut



#### NON-METALLIC WIRE MESH GRIP





# PUSHBUTTON/TEST INSTRUMENTS

## WATERTITE® Pendant Stations

Watertite® pendant stations are rugged enough to withstand the most hostile industrial environments, yet ergonomically designed to fit an operator's hand. Unlimited combinations allow the customization of your own 2-, 4-, 6-, 8-, 10-, and 12-button pendant stations. Choose from single to three-speed switches, E-stop switches, key switches, and indicator lights. The lightweight housing is impact resistant and rated to NEMA 4X.

**Build your part number:** Use the following chart to specify your pendant station's specifications. All pendant stations use F3 size cord grips for cords ranging 0.375-0.812" in diameter.

| 5056-1            |    | 5056-1                               |    |
|-------------------|----|--------------------------------------|----|
| NUMBER OF BUTTONS |    | NUMBER OF SPEEDS                     |    |
| 2 BUTTONS         | 52 | SINGLE SPEED                         | 1  |
| 4 BUTTONS         | 54 | TWO SPEED                            | 2  |
| 6 BUTTONS         | 56 | THREE SPEED                          | 3  |
| 8 BUTTONS         | 58 | MOMENTARY <sup>1</sup>               | M  |
| 10 BUTTONS        | 60 | MAINTAINED <sup>1</sup>              | N  |
| 12 BUTTONS        | 62 | SINGLE SPEED MAINTAINED <sup>1</sup> | 1N |
|                   |    | SINGLE SPEED MOMENTARY <sup>1</sup>  | 1M |
|                   |    | TWO SPEED MAINTAINED <sup>1</sup>    | 2N |
|                   |    | TWO SPEED MOMENTARY <sup>1</sup>     | 2M |
|                   |    | THREE SPEED MAINTAINED <sup>1</sup>  | 3N |
|                   |    | THREE SPEED MOMENTARY <sup>1</sup>   | 3M |

<sup>1</sup> MOMENTARY AND MAINTAINED REFER TO ON/OFF BUTTON ONLY IN FIRST AND SECOND POSITION.



**Pendant Station**  
 • 6 button  
 • single speed  
 part no. 5056-1

## Accessory/Replacement Parts

| PART NO.    | TYPE              | DESCRIPTION                       |
|-------------|-------------------|-----------------------------------|
| 505SS-2     | OPTIONAL SWITCHES | 2-POSITION SELECTOR               |
| 505SS-3NC   | OPTIONAL SWITCHES | 3-POSITION SELECTOR, NC IN CENTER |
| 505SS-3NO   | OPTIONAL SWITCHES | 3-POSITION SELECTOR, NO IN CENTER |
| 505SK-2     | OPTIONAL SWITCHES | KEY SWITCH, 2-POSITION ON/OFF     |
| 505SK-3     | OPTIONAL SWITCHES | 3-POSITION SELECTOR KEY           |
| 505B-RM     | OPTIONAL SWITCHES | RED E-STOP                        |
| 505PL-RS    | PILOT LIGHT       | RED, SHROUD MOUNT                 |
| 505PL-GS    | PILOT LIGHT       | GREEN, SHROUD MOUNT               |
| 505PL-WS    | PILOT LIGHT       | WHITE, SHROUD MOUNT               |
| 505PL-YS    | PILOT LIGHT       | YELLOW, SHROUD MOUNT              |
| 505SW-1     | TWO BUTTON SWITCH | SINGLE SPEED                      |
| 505SW-1N0NC | TWO BUTTON SWITCH | SINGLE SPEED NO/NC                |
| 505SW-12NO  | TWO BUTTON SWITCH | SINGLE SPEED 2NO                  |
| 505SW-2     | TWO BUTTON SWITCH | TWO SPEED                         |
| 505SW-3     | TWO BUTTON SWITCH | THREE SPEED                       |
| 505SW-M     | TWO BUTTON SWITCH | MOMENTARY ON/OFF                  |
| 505SW-N     | TWO BUTTON SWITCH | MAINTAINED ON/OFF                 |
| 505SW-NN0NC | TWO BUTTON SWITCH | MAINTAINED ON/OFF NO/NC           |

| PART NO.  | TYPE                   | DESCRIPTION                         |
|-----------|------------------------|-------------------------------------|
| 505E-2    | ENCLOSURE <sup>1</sup> | 2-BUTTON                            |
| 505E-4    | ENCLOSURE <sup>1</sup> | 4-BUTTON                            |
| 505E-6    | ENCLOSURE <sup>1</sup> | 6-BUTTON                            |
| 505E-8    | ENCLOSURE <sup>1</sup> | 8-BUTTON                            |
| 505E-10   | ENCLOSURE <sup>1</sup> | 10-BUTTON                           |
| 505E-12   | ENCLOSURE <sup>1</sup> | 12-BUTTON                           |
| 505E-TS   | ENCLOSURE <sup>1</sup> | F2 0.375-0.812" CORD DIA.           |
| 505E-TL   | ENCLOSURE <sup>1</sup> | F3 0.812-1.00" CORD DIA.            |
| 505BC-C   | BUTTON COVER BLACK     | HIGH AMBIENT, CHEM. RESISTANT       |
| 505BC-L   | ACCESSORIES            | LEGEND SHEET                        |
| 505BC-LNS | ACCESSORIES            | LENS                                |
| 505M-TAG  | ACCESSORIES            | PENDANT WIRING TAG                  |
| 08336     | ACCESSORIES            | CORD GRIP KIT                       |
| 5628M     | ACCESSORIES            | CORD GRIP WIRE MESH 0.375-0.437" F3 |
| 5633M     | ACCESSORIES            | CORD GRIP WIRE MESH 0.437-0.562" F3 |
| 5635M     | ACCESSORIES            | CORD GRIP WIRE MESH 0.56-0.687" F3  |
| 5645M     | ACCESSORIES            | CORD GRIP WIRE MESH 0.687-0.812" F3 |

<sup>1</sup> REPLACEMENT ENCLOSURES INCLUDE SHELL ASSEMBLY, BUTTON HOODS, LEGENDS AND HARDWARE

UL SP MOST WOODHEAD PRODUCTS HAVE U.L. AND/OR CSA APPROVALS. FOR A LISTING OF APPROVALS BY PART NUMBER, SEE PAGES 262-269.

## WATERTITE® Pushbutton Control for AC and DC Motors

Watertite® Pushbutton Control for AC and DC Motors are CSA certified and meet NEMA 1, 2, 3, 3R, 4, 4X, 6, 12, and 13, military specifications and OSHA requirements. It features a nylon MAX-LOC® (F2-1/2 in. NPT) cord grip with four grommets to accommodate cord sizes from .312-.625 O.D. The switches are a single speed, double throw, momentary contact type and can be wired normally-open or normally-closed. It also features a nylon enclosure and coverplate with rubber pushbutton diaphragm that provides water tight integrity. The 4052 PC consists of a 4052 pendant station with a 24VDC indicating light in the bottom position, five feet of #16/5 cord, and a Brad Harrison® 5 pole Mini-Change® connector. The parts call system provides a quick and effective means of communication for assembly-line manufacturing. Consult factory for more details or variations.

### Switch Characteristics

Contact Arrangement: Single speed SPDT-DB

#### Continuous

10A @ 125 TO 250VAC  
 1/2 HP @ 125VAC  
 3/4 HP @ 250VAC  
 1 HP @ 125VAC OR 250VAC  
 7A 28VDC IND.  
 10A 28VDC RES.

#### Control

120VAC 60A MAKE 6A BREAK  
 240VAC 30A MAKE 3A BREAK  
 A-300 CONTACT RATING PER U.L. STD. 508

### BEST SELLERS!

#### Pushbutton Pendant Control

- single speed

part no. 4052



### Pushbutton Pendant Controls

| PART NO. | DESCRIPTION               | CORD DIAMETER RANGE |
|----------|---------------------------|---------------------|
| 4052     | 2-BUTTON SINGLE SPEED     | 0.312-0.625"        |
| 4052PC   | PARTS CALL SYSTEM PENDANT | 0.250-0.625"        |

### Wire Mesh Grip Kit For Pendant Station, Plastic Nut

| PART NO. | NUT     | MESH            | SIZE | CORD DIA. RANGE |
|----------|---------|-----------------|------|-----------------|
| 5630M    | PLASTIC | STAINLESS STEEL | F2   | 0.312-0.375"    |
| 5630NM   | PLASTIC | NON-METALLIC    | F2   | 0.312-0.375"    |
| 5631M    | PLASTIC | STAINLESS STEEL | F2   | 0.375-0.437"    |
| 5631NM   | PLASTIC | NON-METALLIC    | F2   | 0.375-0.437"    |
| 5632M    | PLASTIC | STAINLESS STEEL | F2   | 0.437-0.500"    |
| 5632NM   | PLASTIC | NON-METALLIC    | F2   | 0.437-0.500"    |

### Replacement Parts

| PART NO.      | DESCRIPTION  |
|---------------|--|
| 42-2190       | REPLACEMENT SWITCH – ONE SPEED, MOMENTARY SWITCH                 |
| 00-5150       | RUBBER SWITCH DIAPHRAGM  |
| 31-5800       | LEGEND KIT – LABELS: FUNCTION, PUSHBUTTON STATION                |
| 105002A01F060 | 6' OF #16/5 CORD AND BRAD HARRISON 5 POLE MINI-CHANGE® CONNECTOR |



#### Pushbutton Pendant Control

- parts call system pendant

part no. 4052pc



MOST WOODHEAD PRODUCTS HAVE U.L. AND/OR CSA APPROVALS. FOR A LISTING OF APPROVALS BY PART NUMBER, SEE PAGES 262-269.

# PUSHBUTTON/TEST INSTRUMENTS

## SUPER-SAFEWAY® Weather-Resistant Pushbutton Covers for F.S./F.D. Boxes

Woodhead's weather-resistant pushbutton covers transform your F.S./F.D. box into a pendant station. Constructed of NEOTEX® rubber, the cover includes integral pushbuttons that can be wired normally-open or normally closed. Flat green and rounded red button inserts aid in proper operation. Switches are single or two speed momentary contact type and the single speed switches can be wired with electrical interlock.

### BEST SELLERS!

#### Weatherproof Push Button

- single speed

part no. 4032 (shown)

#### Weatherproof Push Button

- two speed

part no. 4032-2

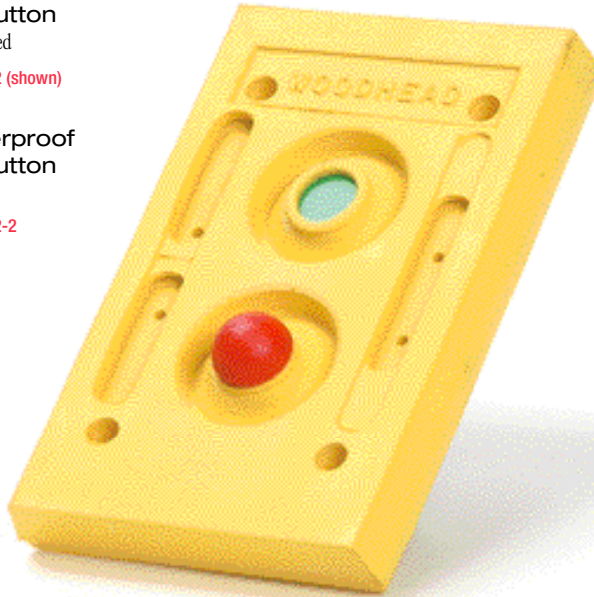

#### Switch Ratings

##### Single speed

20A @ 125 to 480VAC  
5A @ 600VAC  
1 HP @ 125VAC  
2 HP @ 250VAC

##### Two speed

10A @ 125 or 250VAC  
1/3 HP @ 125V  
1/2 HP @ 250V

## Weather-Resistant Pushbutton Covers

| PART NO. | SPEEDS       |
|----------|--------------|
| 4032     | SINGLE SPEED |
| 4032-2   | TWO SPEED    |

## Replacement Parts

| PART NO. | SPEEDS    | DESCRIPTION      |
|----------|-----------|------------------|
| 4020     | ONE SPEED | MOMENTARY SWITCH |
| 4020-2   | TWO SPEED | MOMENTARY SWITCH |

## Swinger Switches<sup>1</sup>

| PART NO. | DESCRIPTION                  |
|----------|------------------------------|
| 55501    | SWINGER 2P SWITCH SPST NO    |
| 55503    | SWINGER 3P SWITCH SPDT NO/NC |
| 55504    | SWINGER 3P SWITCH SPST NO    |

<sup>1</sup> SEE PAGE 222 FOR MATING CONNECTORS.

UL SP MOST WOODHEAD PRODUCTS HAVE U.L. AND/OR CSA APPROVALS. FOR A LISTING OF APPROVALS BY PART NUMBER, SEE PAGES 262-269.

## Swinger Switch

part no. 55501



## SUPER-SAFEWAY® Pendant Pushbutton Enclosures

Features NEOTEX® rubber construction, strain-relief sealing grip, metal suspension bracket for messenger cord, and internal ground strip. Accepts all standard 30mm or 22mm oil-tight pushbuttons, indicator lights, and selector switches. Switches not included. Wire mesh grip ordered separately.

### Pushbutton Pendants

| PART NO. | NO. OF BUTTONS | OPENING SIZE | CORD GRIP |         | CORD DIA. RANGE |
|----------|----------------|--------------|-----------|---------|-----------------|
|          |                |              | SIZE      | NUT     |                 |
| 4002     | 2              | 30mm         | F3        | PLASTIC | 0.375-0.625"    |
| 4003     | 3              | 30mm         | F4        | METAL   | 0.500-0.875"    |
| 4004     | 4              | 30mm         | F4        | METAL   | 0.500-0.875"    |
| 4005     | 5              | 30mm         | F4        | METAL   | 0.625-1.000"    |
| 4006     | 6              | 30mm         | F4        | METAL   | 0.625-1.000"    |
| 4007     | 7              | 30mm         | F4        | METAL   | 0.625-1.000"    |
| 4008     | 8              | 30mm         | F4        | METAL   | 0.625-1.000"    |
| 4009     | 9              | 30mm         | F4        | METAL   | 0.625-1.000"    |
| 4010     | 10             | 30mm         | F4        | METAL   | 0.625-1.000"    |
| 4011     | 11             | 30mm         | F4        | METAL   | 0.625-1.000"    |
| 4012     | 12             | 30mm         | F4        | METAL   | 0.625-1.000"    |
| 4202     | 2              | 22mm         | F3        | PLASTIC | 0.375-0.625"    |
| 4203     | 3              | 22mm         | F4        | METAL   | 0.500-0.875"    |
| 4204     | 4              | 22mm         | F4        | METAL   | 0.500-0.875"    |
| 4205     | 5              | 22mm         | F4        | METAL   | 0.625-1.000"    |
| 4206     | 6              | 22mm         | F4        | METAL   | 0.625-1.000"    |
| 4207     | 7              | 22mm         | F4        | METAL   | 0.625-1.000"    |
| 4208     | 8              | 22mm         | F4        | METAL   | 0.625-1.000"    |
| 4209     | 9              | 22mm         | F4        | METAL   | 0.625-1.000"    |
| 4212     | 12             | 22mm         | F4        | METAL   | 0.625-1.000"    |

### Replacement Part

| PART NO. | DESCRIPTION |
|----------|-------------|
| 71-4220  | LEGEND KIT  |

### Wire Mesh Grip Kits for Pendant Stations

A full range of accessories are available for pushbutton pendant stations. Wire mesh grip kits are ideal for providing the additional strain-relief needed to protect cords from the stress exerted on conductors entering the pushbutton enclosure.

| PART NO. | NUT      | MESH            | SIZE | CORD DIA. RANGE |
|----------|----------|-----------------|------|-----------------|
| 5633M    | PLASTIC  | STAINLESS STEEL | F3   | 0.437-0.500"    |
| 5633NM   | PLASTIC  | NON-METALLIC    | F3   | 0.437-0.500"    |
| 5634M    | PLASTIC  | STAINLESS STEEL | F3   | 0.500-0.625"    |
| 5634NM   | PLASTIC  | NON-METALLIC    | F3   | 0.500-0.625"    |
| 5635M    | PLASTIC  | STAINLESS STEEL | F3   | 0.562-0.687"    |
| 5635NM   | PLASTIC  | NON-METALLIC    | F3   | 0.562-0.687"    |
| 5636M    | PLASTIC  | STAINLESS STEEL | F4   | 0.562-0.687"    |
| 5636NM   | PLASTIC  | NON-METALLIC    | F4   | 0.562-0.687"    |
| 5637M    | PLASTIC  | STAINLESS STEEL | F4   | 0.625-0.750"    |
| 5637NM   | PLASTIC  | NON-METALLIC    | F4   | 0.625-0.750"    |
| 5638M    | PLASTIC  | STAINLESS STEEL | F4   | 0.750-0.875"    |
| 5638NM   | PLASTIC  | NON-METALLIC    | F4   | 0.750-0.875"    |
| 5639M    | PLASTIC  | STAINLESS STEEL | F4   | 0.875-1.000"    |
| 5639NM   | PLASTIC  | NON-METALLIC    | F4   | 0.875-1.000"    |
| 42-2040  | ALUMINUM | STAINLESS STEEL | F3   | 0.500-0.625"    |
| 42-2060  | ALUMINUM | STAINLESS STEEL | F3   | 0.625-0.750"    |
| 42-2080  | ALUMINUM | STAINLESS STEEL | F4   | 0.500-0.625"    |
| 42-2090  | ALUMINUM | STAINLESS STEEL | F4   | 0.625-0.750"    |
| 42-2110  | ALUMINUM | STAINLESS STEEL | F4   | 0.750-0.875"    |
| 42-2130  | ALUMINUM | STAINLESS STEEL | F4   | 0.875-1.000"    |

### BEST SELLERS!



#### Six-Button Pendant

- 22mm opening
- F3 cord size
- metal nut
- 0.625-1.000" cord diameter range

part no. 4206

#### Two-Button Pendant

- 30mm opening
- F4 cord size
- metal nut
- 0.375-0.625" cord diameter range

part no. 4006

### BEST SELLERS!

#### Stainless Steel Mesh Grip Kit

- F3 cord grip
- plastic nut



NON-METALLIC WIRE MESH GRIP



MOST WOODHEAD PRODUCTS HAVE U.L. AND/OR CSA APPROVALS.  
FOR A LISTING OF APPROVALS BY PART NUMBER, SEE PAGES 262-269.

## PUSHBUTTON/TEST INSTRUMENTS

### SUPER-SAFEWAY® Test Instruments

#### Receptacle Circuit Tester

U.L. listed. Compact tester has three neon indicating lights which provide a convenient way to test 3 wire, 115VAC, single phase, polarized outlets. Checks for correct wiring, reversed polarity, open ground, open neutral, open hot, hot and ground reversed and hot on neutral/hot unwired.

part no. 1750

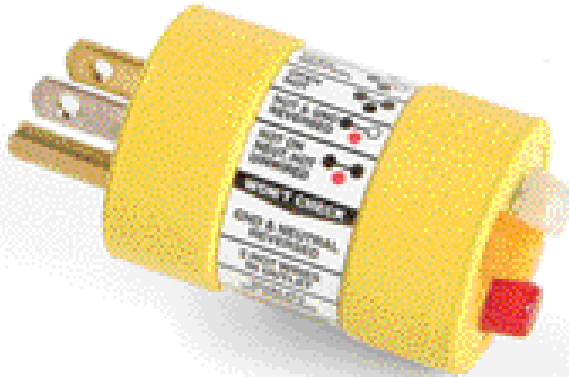

#### Combination Receptacle Circuit Tester and GFCI Tester

U.L. listed. Combination, compact tester has three neon indicating lights that provide a convenient way to test 3 wire, 115VAC, single phase, polarized outlets. Checks for proper GFCI operation, correct wiring, reversed polarity, open ground, open neutral, open hot, hot and ground reversed and hot on neutral/hot unwired.

part no. 1751



#### Circuit Tester and Tool Ground Continuity Tester

Tester checks receptacle circuits and determines grounding conductor continuity between the noncurrent carrying metal parts of a tool and the grounding blade of its power cord. For use with 3 wire, 115VAC, single phase, polarized receptacles.

part no. 1756

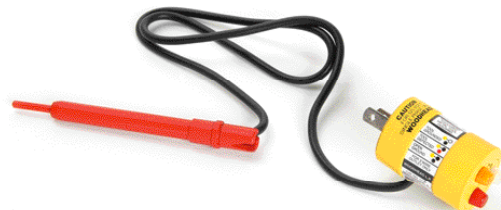

MOST WOODHEAD PRODUCTS HAVE U.L. AND/OR CSA APPROVALS.  
FOR A LISTING OF APPROVALS BY PART NUMBER, SEE PAGES 262-269.

## SUPER-SAFEWAY® Test Instruments

### Receptacle Tension Tester

Provides a simple way to check the spring contact tension of a standard straight blade receptacle.

Designed to test outlets with the following ratings:

15A, 125V, 2 pole, 2 wire; 15A, 125V, 2 pole, 3 wire;

20A, 125V, 2 pole, 3 wire. Completely insulated in

an impact-resistant plastic housing and is safe to

use on energized receptacles. Each blade has an

independent spring to relieve stress and assure

consistent readings over a long life. When tension

falls below 10 ounces, that tells you to monitor the

receptacle closely for further deterioration. Tension

of 4 ounces is the lowest point which a receptacle

should be allowed to remain in service. NFPA

Standard 99-1996, Ref. 3-3.3.3(d).

part no. 1760



### Combo-Kit

1760 Tension Tester and 1750 Circuit Tester in Carrying Case

part no. 1770



MOST WOODHEAD PRODUCTS HAVE U.L. AND/OR CSA APPROVALS.  
FOR A LISTING OF APPROVALS BY PART NUMBER, SEE PAGES 262-269.



## PUSHBUTTON/TEST INSTRUMENTS

### ANTI-STATIC GROUNDING REEL

Steel construction and instant-acting lock-and-release mean durability and ease of use. Supplied galvanized steel aviation cord is 3/32" dia. Equipped with 100 amp ground clamp and rubber bumper. Cord resistance is one ohm through entire unit.

#### BEST SELLER!

##### Static Ground Reel

- galvanized steel
- 25' cord

part no. 143025



### Anti-Static Grounding Reel

| PART NO. | CORD TYPE                    | CORD LENGTH |
|----------|------------------------------|-------------|
| 143025   | GALVANIZED STEEL             | 25'         |
| 143025NC | NYLON COATED STEEL           | 25'         |
| 143050   | GALVANIZED STEEL             | 50'         |
| 143050NC | NYLON COATED STEEL           | 50'         |
| 143050SS | STAINLESS STEEL              | 50'         |
| 143051   | GALVANIZED STEEL W/ Y-SPLICE | 50'         |



MOST WOODHEAD PRODUCTS HAVE U.L. AND/OR CSA APPROVALS.  
FOR A LISTING OF APPROVALS BY PART NUMBER, SEE PAGES 262-269.

## ANTI-STATIC BONDING AND GROUNDING SETS

Woodhead bonding sets provide a fast means of bonding and grounding hazardous liquid containers. Available with a variety of attachments, they are engineered to meet the requirements of almost any application. Constructed of No. 8 flexible conductors and corrosion-resistant connections, Woodhead bonding sets are offered in 3 ft. or 6 ft. lengths.

### BEST SELLER!

#### 6' Bond Assembly with Two J-Clamps

- 6' of No. 8 flexible conductors
- both ends J-clamps

part no. 142006



### Anti-Static Bonding and Grounding Sets

| PART NO. | LENGTH | FIRST END | SECOND END   |
|----------|--------|-----------|--------------|
| 140003   | 3'     | TERMINAL  | TERMINAL     |
| 140006   | 6'     | TERMINAL  | TERMINAL     |
| 141003   | 3'     | J-CLAMP   | TERMINAL     |
| 141006   | 6'     | J-CLAMP   | TERMINAL     |
| 141103   | 3'     | J-CLAMP   | PIPE CLAMP   |
| 141106   | 6'     | J-CLAMP   | PIPE CLAMP   |
| 141203   | 3'     | J-CLAMP   | BEAM CLAMP   |
| 141206   | 6'     | J-CLAMP   | BEAM CLAMP   |
| 141303   | 3'     | J-CLAMP   | BATTERY CLIP |
| 141306   | 6'     | J-CLAMP   | BATTERY CLIP |
| 142003   | 3'     | J-CLAMP   | J-CLAMP      |
| 142006   | 6'     | J-CLAMP   | J-CLAMP      |

### Accessories

| PART NO. | DESCRIPTION                                  |
|----------|--|
| 30-0310  | PIPE CLAMP END                               |
| 30-0321  | BEAM CLAMP END WITH 10-32 HOLES              |
| 36-0660  | BARREL CLAMP END – J-CLAMP END               |
| 36-0670  | BATTERY CLIP END – 75 AMP                    |
| 36-0690  | COMPRESSION CONNECTOR (#8-#6) – TERMINAL END |

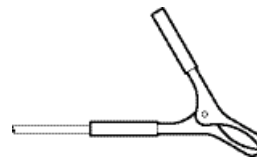

Battery Clip

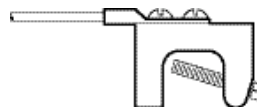

Beam Clamp

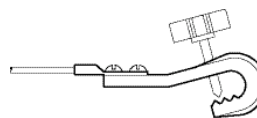

J-Clamp

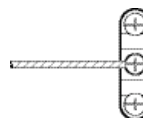

Pipe Clamp



Terminal

 MOST WOODHEAD PRODUCTS HAVE U.L. AND/OR CSA APPROVALS. FOR A LISTING OF APPROVALS BY PART NUMBER, SEE PAGES 262-269.

# PUSHBUTTON/TEST INSTRUMENTS

## TECHNICAL REFERENCE Assembly Instructions

### Single Speed Interlock Applications

When a set of two pushbuttons is used to control complementary functions such as Up-Down, Open-Close, Left-Right, etc., the two buttons should be wired as shown in the diagram below to provide an electrical interlock. This electrical interlock method of wiring provides two primary benefits:

1. It prevents the simultaneous operation of both functions, thus protecting equipment from damage.
2. If a pushbutton switch should fail, depressing the complementary button opens the control circuit, thus providing an emergency stop.

The switches supplied with this station are rated at currents substantially higher than those normally encountered in control applications. It should be noted, however, that electrical failures in associated equipment can cause currents to flow which far exceed even these high ratings.

Circuit schematic for 2 single switches wired for interlock:

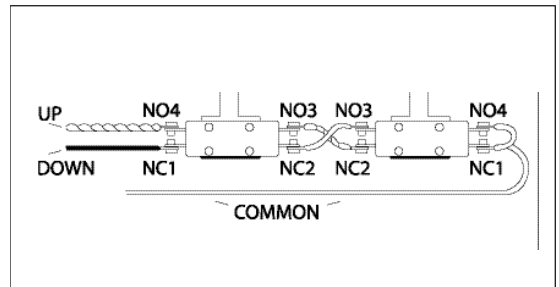
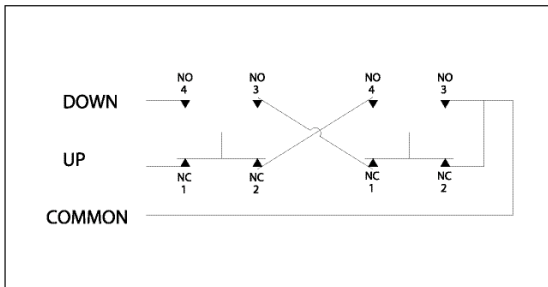

NOTE: NO – NORMALLY-OPEN; NC – NORMALLY-CLOSED.

### Two-Speed Contact Ratings

| VOLTS  | AC CURRENT | HORSEPOWER |
|--------|------------|------------|
| 125VAC | 10         | 1/3 HP     |
| 250VAC | 10         | 1/2 HP     |

NOTE: SWITCHES ARE U.L. LISTED.

Circuit Schematic:

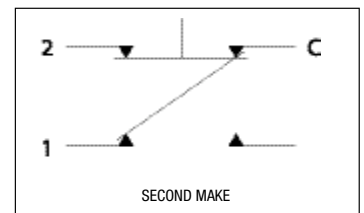
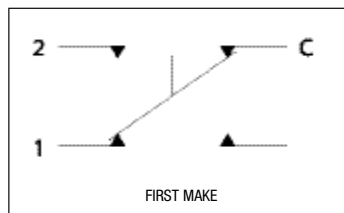
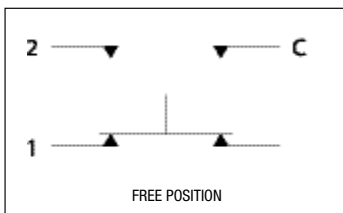

## TECHNICAL REFERENCE

### Legend for 4020 and 4052 Series Pushbutton Stations

|        |        |          |
|--------|--------|----------|
| BRIDGE | LEFT   | RIGHT    |
| CRANE  | LOW    | RAISE    |
| CLOSE  | MAGNET | SOUTH    |
| DOWN   | NORTH  | STOP     |
| DOOR   | NO. 1  | START    |
| EAST   | NO. 2  | SLOW     |
| FWD    | NO. 3  | TROLLEY  |
| FAST   | ON     | UP       |
| HIGH   | OPEN   | WEST     |
| HOIST  | OFF    | BLANK(2) |
| IN     | OUT    |          |
| LOWER  | REV    |          |

| SERIES | PART NO. |
|--------|----------|
| 4020   | 71-4220  |
| 4052   | 31-5800  |

### Legend for 4020 and 4052 Series Pushbutton Stations

|       |       |
|-------|-------|
| OFF   | ON    |
| UP    | DOWN  |
| LEFT  | RIGHT |
| FWD   | REV   |
| NORTH | SOUTH |
| EAST  | WEST  |
| OPEN  | CLOSE |
| IN    | OUT   |
| RAISE | LOWER |
| START | STOP  |

| SERIES | PART NO. |
|--------|----------|
| 5050   | 505BC-L  |



For over 35 years, Brad Harrison products have been the standard for innovation and superior engineering in quick disconnect systems. What began as a safe, fast and efficient alternative to hard wiring has expanded into industry's broadest line of quick-disconnect solutions, designed to reduce time, expense and maintenance on the job.

The diverse Brad Harrison family ranges from time-saving Multi-Port Interconnection Systems that help consolidate control system wiring, to Mini-Change® and Micro-Change® industrial connectors, capable of meeting industry's highest standards for signal integrity.

Around the globe, across industries, in the toughest industrial settings imaginable, top-performing Brad Harrison quick-disconnect systems consistently earn their reputation of quality, durability and superior performance.

### **Mini-Change Connectors**

The ultimate in simplified wiring and maintenance. Used in conjunction with 18mm and 30mm tubular proximity sensors, limit switches, rectangular proximity sensors, and solenoids.

### **Micro-Change Connectors**

Specially engineered to withstand harsh industrial environments, Micro-Change connectors are the answer to today's demanding automation requirements. Used in conjunction with 12mm and 18mm tubular photoelectric sensors, and modular controls.

### **Nano-Change® Connectors**

Small and mighty, Nano-Change connectors facilitate fast, simple and error-free maintenance in all types of industrial settings. Used in conjunction with miniature (8mm or smaller) proximity sensors, photoelectric sensors, and other control components.

### **Brad® Power Connection Systems**

Modular, flexible, scalable and code-compliant quick-connect wiring solutions that offer lower installed cost and faster commissioning of industrial machinery. Flexibility and low cost is achieved by eliminating the need for conduit to run power to industrial machinery. Using Brad Power products allow a trunk/feeder line to be installed along the machine's structure with convenient access points for power to be dropped to field devices such as motors, lights, heaters and other electrical devices. Brad Power systems offer quick and easy installations without the tools, threading, pipe bending and wire pulling involved in installing conduit.



## MINI-CHANGE® CORDSETS/ RECEPTACLES

- #16 AWG yellow ST00W cable – U.S. color code
- Oil-resistant PVC jacket
- Low-resistance contact design with gold over palladium nickel plating.

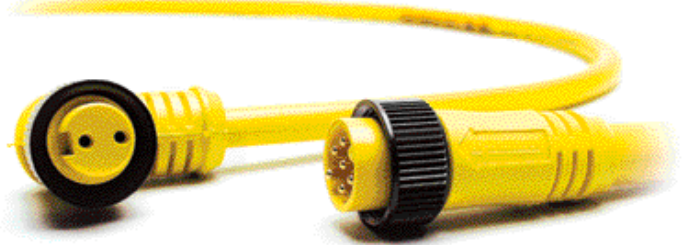

### Single and Double-Ended Cordsets

|                         | 2P                     | 3P   | 4P  | 5P  | 6P  |
|-------------------------|------------------------|--|---|---|---|
| <b>FEMALE FACE VIEW</b> |                        |  |   |   |   |
| <b>COLOR CODES</b>      | 1 – WHITE<br>2 – BLACK | 1 – GREEN (GRND)<br>2 – BLACK<br>3 – WHITE | 1 – BLACK<br>2 – RED<br>3 – WHITE<br>4 – GREEN (GRND) | 1 – WHITE<br>2 – RED<br>3 – GREEN (GRND)<br>4 – ORANGE<br>5 – BLACK | 1 – WHITE<br>2 – RED<br>3 – GREEN (GRND)<br>4 – ORANGE<br>5 – BLACK<br>6 – BLUE |
| <b>VOLTAGE</b>          | 600VAC/DC              | 600VAC/DC                                  | 600VAC/DC   | 600VAC/DC   | 600VAC/DC   |
| <b>CURRENT</b>          | 13A                    | 13A  | 10A   | 8A  | 8A  |
| <b>CONDUCTOR</b>        | #16/2                  | #16/3                                      | #16/4   | #16/5   | #16/6   |

### Female Single-Ended Cordsets with 3' #16 AWG ST00W cable

| CONFIGURATION                   | 2P            | 3P            | 4P            | 5P            | 6P            |
|---------------------------------|---------------|---------------|---------------|---------------|---------------|
| STRAIGHT (FIG. 1)               | 102000A01F030 | 103000A01F030 | 104000A01F030 | 105000A01F030 | 106000A01F030 |
| 90° (FIG. 2)                    | 102001A01F030 | 103001A01F030 | 104001A01F030 | 105001A01F030 | 106001A01F030 |
| MATING MALE RECEPTACLE (FIG. 5) | 1R2006A20A120 | 1R3006A20A120 | 1R4006A20A120 | 1R5006A20A120 | 1R6006A20A130 |

### Male Single-Ended Cordsets with 3' #16 AWG ST00W cable

| CONFIGURATION                     | 2P            | 3P            | 4P            | 5P            | 6P            |
|-----------------------------------|---------------|---------------|---------------|---------------|---------------|
| STRAIGHT (FIG. 3)                 | 102002A01F030 | 103002A01F030 | 104002A01F030 | 105002A01F030 | 106002A01F030 |
| 90° (FIG. 4)                      | 102003A01F030 | 103003A01F030 | 104003A01F030 | 105003A01F030 | 106003A01F030 |
| MATING FEMALE RECEPTACLE (FIG. 5) | 1R2004A20A120 | 1R3004A20A120 | 1R4004A20A120 | 1R5004A20A120 | 1R6004A20A130 |

### Female/Male Double-Ended Cordsets with 3' #16 AWG ST00W cable

| CONFIGURATION                | 2P            | 3P            | 4P            | 5P            | 6P            |
|------------------------------|---------------|---------------|---------------|---------------|---------------|
| STRAIGHT/STRAIGHT (FIG. 1/3) | 112020A01F030 | 113020A01F030 | 114020A01F030 | 115020A01F030 | 116020A01F030 |
| 90°/STRAIGHT (FIG. 2/3)      | 112021A01F030 | 113021A01F030 | 114021A01F030 | 115021A01F030 | 116021A01F030 |
| STRAIGHT/90° (FIG. 1/4)      | 112022A01F030 | 113022A01F030 | 114022A01F030 | 115022A01F030 | 116022A01F030 |
| 90°/90° (FIG. 2/4)           | 112023A01F030 | 113023A01F030 | 114023A01F030 | 115023A01F030 | 116023A01F030 |

NOTE: FOR MATING TWO CORDSETS, USE THREADED UNION #55-0426

Options: Use the following chart to modify your part's specifications.

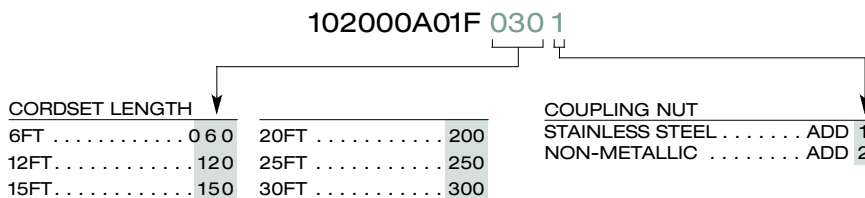

UL SP MOST WOODHEAD PRODUCTS HAVE U.L. AND/OR CSA APPROVALS. FOR A LISTING OF APPROVALS BY PART NUMBER, SEE PAGES 262-269.

SPECIFICATIONS

MECHANICAL

CONNECTOR FACE: PVC - UL STD 94 - V0  
 MOLDED BODY: PVC - UL STD 94 - V0  
 COUPLING NUT: ZINC DIECAST W/ BLACK EPOXY  
 E-COAT, OPTIONAL STAINLESS STEEL  
 TYPE 303 OR NON-METALLIC GRAY  
 NYLON 6/6  
 CABLE: YELLOW, #16 AWG, PVC JACKET,  
 PVC CONDUCTOR INSULATION OVER  
 65 X #34 COPPER STRANDING, UL  
 ST00W CSA ST  
 CABLE DIAMETER: 2P - 0.37" (9.4mm)  
 3P - 0.41" (10.4mm)  
 4P - 0.42" (10.7mm)  
 5P - 0.50" (12.7mm)  
 6P - 0.54" (13.7mm)

ELECTRICAL

VOLTAGE RATING: 600VAC/DC  
 AMPERAGE: 2P - 13A  
 3P - 13A  
 4P - 10A  
 5P - 8A  
 6P - 8A

ENVIRONMENTAL

PROTECTION: IP 68 NEMA 6P  
 AMBIENT OPERATING TEMP: -4 TO 221° F (-20 TO 105° C)

Connector Dimensions

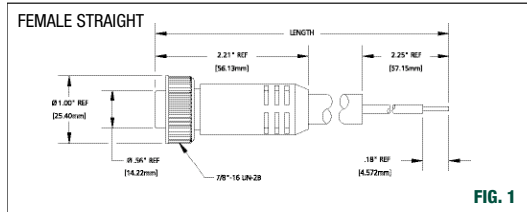

FIG. 1

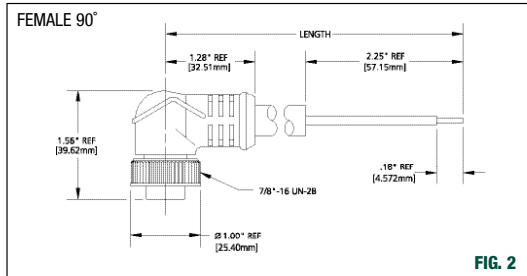

FIG. 2

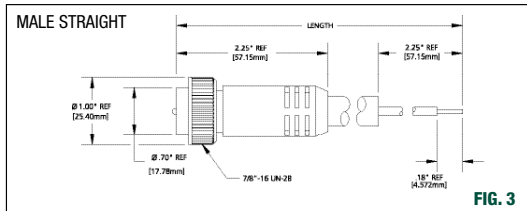

FIG. 3

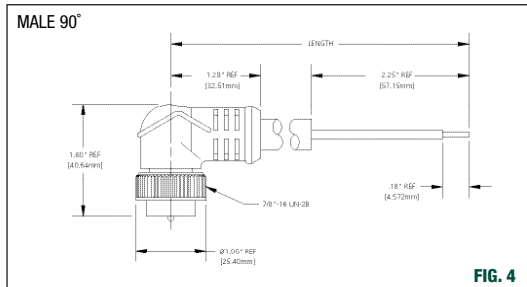

FIG. 4

Receptacle Dimensions

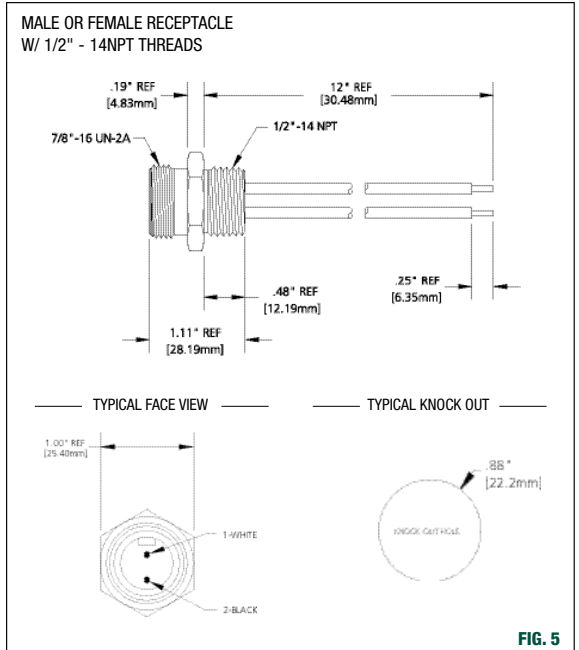

FIG. 5

## MINI-CHANGE® CONNECTORS/ RECEPTACLES

- Allows easy field conversion to quick disconnect
- Male with internal or external threads – female with internal threads
- Secure screw terminals #15 AWG to #24 AWG – compatible with existing Mini-Change



### Field-Attachable Connectors

|  | 3P                          | 4P                          | 5P                          |
|--|-----------------------------|-----------------------------|-----------------------------|
| <b>FEMALE FACE VIEW</b>                      |                             |                             |                             |
| <b>VOLTAGE</b>                               | 600VAC/DC                   | 600VAC/DC                   | 600VAC/DC                   |
| <b>CURRENT</b>                               | 13A                         | 10A                         | 8A                          |
| <b>CABLE RANGE</b>                           | 0.20-0.48" O.D.<br>(5-12mm) | 0.20-0.48" O.D.<br>(5-12mm) | 0.20-0.48" O.D.<br>(5-12mm) |
| <b>CONFIGURATION</b>                         | <b>3P</b>                   | <b>4P</b>                   | <b>5P</b>                   |
| FEMALE STRAIGHT W/ INTERNAL THREADS (FIG. 1) | 1A3000-34                   | 1A4000-34                   | 1A5000-34                   |
| MATING MALE RECEPTACLE (FIG. 4)              | 1R3006A20A120               | 1R4006A20A120               | 1R5006A20A120               |
| MALE STRAIGHT W/ EXTERNAL THREADS (FIG. 2)   | 1A3006-34                   | 1A4006-34                   | 1A5006-34                   |
| MATING FEMALE RECEPTACLE (FIG. 5)            | 1R3000A20A120               | 1R4000A20A120               | 1R5000A20A120               |
| MALE STRAIGHT W/ INTERNAL THREADS (FIG. 3)   | 1A3002-34                   | 1A4002-34                   | 1A5002-34                   |
| MATING FEMALE RECEPTACLE (FIG. 6)            | 1R3004A20A120               | 1R4004A20A120               | 1R5004A20A120               |

NOTE: ADD SUFFIX "8" FOR STAINLESS STEEL. EX: 1A3000-34 BECOMES 1A3000-348



MOST WOODHEAD PRODUCTS HAVE U.L. AND/OR CSA APPROVALS.  
FOR A LISTING OF APPROVALS BY PART NUMBER, SEE PAGES 262-269.

SPECIFICATIONS

**MECHANICAL**

CONNECTOR FACE: POLYURETHANE  
 BODY: POLYAMIDE PA6  
 CONTACT: GOLD-PLATED BRASS  
 COUPLING NUT: NICKEL-PLATED BRASS  
 GROMMET: NEOPRENE  
 CABLE RANGE O.D.: 0.20-0.48" (5.0-12.0mm)  
 ACCEPTABLE WIRE GAUGE RANGE: #24 AWG (0.25mm<sup>2</sup>) - #15 AWG (2.0mm<sup>2</sup>)

**ELECTRICAL**

VOLTAGE RATING: 600 VAC/DC  
 AMPERAGE: 3P - 13A  
 4P - 10A  
 5P - 8A

**ENVIRONMENTAL**

PROTECTION: IP 68  
 AMBIENT OPERATING TEMP: -40 TO 176° F (-40 TO 80° C)

Connector Dimensions

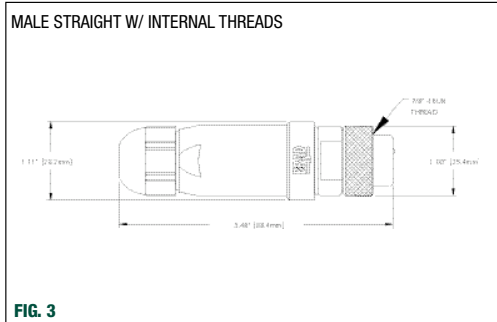
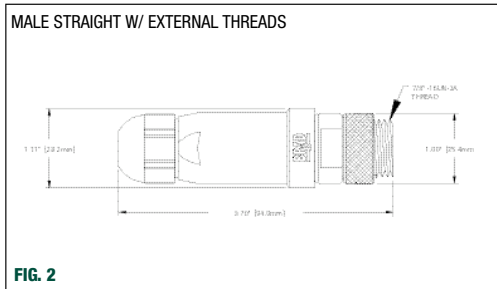
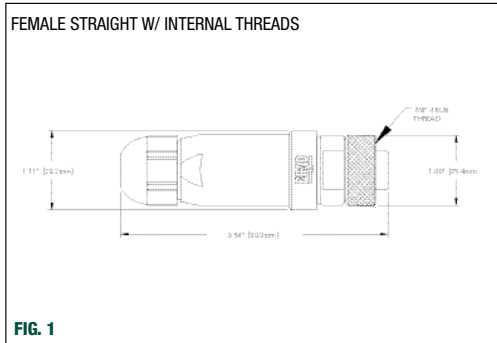

Receptacle Dimensions

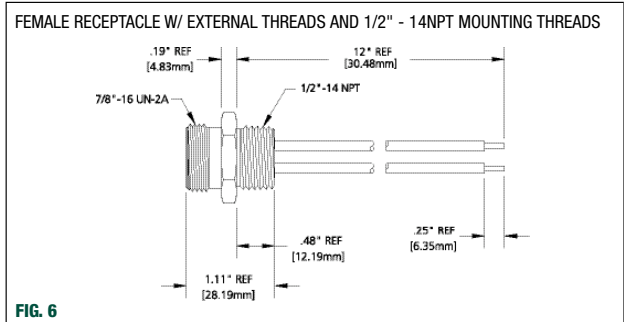
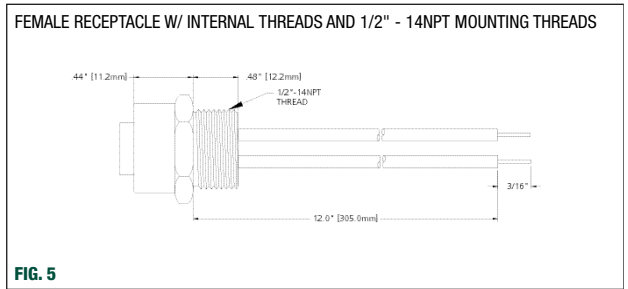
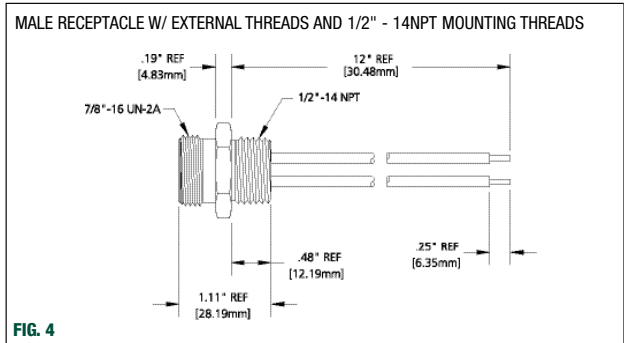

NOTE: SEE PAGE 228 FOR ADDITIONAL RECEPTACLES

## MINI-CHANGE® ACCESSORIES

- Closure caps for receptacles, connectors and Multi-Port distribution blocks
- Threaded unions for mating (2) cordsets
- Female and male plugs for liquid tight conduit terminations
- 90° adapters with (1) male and (1) female plug



### Closure Caps and Threaded Unions

| DESCRIPTION   | 2P TO 6P (A SIZE) |
|---|-------------------|
| ALUMINUM CLOSURE CAP WITH INTERNAL THREADS FOR USE WITH RECEPTACLES & MULTIPORTS (FIG. 1) | 65-0086           |
| ALUMINUM CLOSURE CAP WITH EXTERNAL THREADS FOR USE WITH CORDSETS (FIG. 2)                 | 65-0085           |
| ALUMINUM THREADED UNION FOR MATING TWO CORDSETS (FIG. 3)                                  | 55-0426           |

NOTE: FOR STAINLESS STEEL, ADD "SS" TO PART NUMBER. EX: 65-0086 BECOMES 65-0086SS

### Connectors with 6' long #16 AWG PVC leads for 1/2" liquid tight conduit

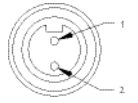
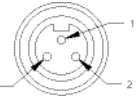
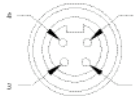
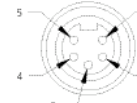
| CONFIGURATION           | 2P  | 3P  | 4P  | 5P   |
|-------------------------|---|---|---|--|
| <b>FEMALE FACE VIEW</b> |  |  |  |  |
| <b>COLOR CODES</b>      | 1 – WHITE<br>2 – BLACK  | 1 – GREEN (GRND)<br>2 – BLACK<br>3 – WHITE  | 1 – BLACK<br>2 – WHITE<br>3 – RED<br>4 – GREEN (GRND)                               | 1 – WHITE<br>2 – RED<br>3 – GREEN (GRND)<br>4 – ORANGE<br>5 – BLACK                  |
| FEMALE (FIG. 4)         | 40718   | 40925   | 41132   | 41344  |
| MALE (FIG. 4)           | 40780   | 41037   | 51149   | 41593  |

FOR RECEPTACLE MOUNTING HARDWARE, SEE PAGE 160.

### 90° Adapters with (1) male plug and (1) female plug

| CONFIGURATION | 2P    | 3P    | 4P    | 5P    |
|---------------|-------|-------|-------|-------|
| 90° (FIG. 5)  | 40761 | 41048 | 41212 | 41481 |



MOST WOODHEAD PRODUCTS HAVE U.L. AND/OR CSA APPROVALS.  
FOR A LISTING OF APPROVALS BY PART NUMBER, SEE PAGES 262-269.

**SPECIFICATIONS**

**MECHANICAL**

CLOSURE CAPS W/ INTERNAL THREADS: GRAY ANODIZED ALUMINUM  
CLOSURE CAPS W/ EXTERNAL THREADS: BLACK ANODIZED ALUMINUM  
THREADED UNION: GRAY ANODIZED ALUMINUM

LIQUID-TIGHT CONNECTORS  
CONNECTOR BODY: ZINC PLATED STEEL  
COUPLING NUT: GRAY ANODIZED ALUMINUM  
CLAMP NUT: ZINC PLATED STEEL  
INSERT: PVC - UL STD 94 - V0  
90° ADAPTER CONNECTOR BODY: YELLOW PVC  
COUPLING NUTS: ZINC DIECAST W/ BLACK EPOXY  
INSERT: PVC - UL STD 94 - V0

**ELECTRICAL**

LIQUID-TIGHT CONNECTORS AND 90° ADAPTORS

VOLTAGE RATING: 600V  
CURRENT:  
2P - 13A  
3P - 10A  
4P - 8A  
5P - 8A

**ENVIRONMENTAL**

PROTECTION: IP67, NEMA 4  
AMBIENT OPERATING TEMP: -4 TO 221° F (-20 TO 105° C)

Accessory Dimensions and Details

ALUMINUM CLOSURE CAPS W/ INTERNAL THREADS

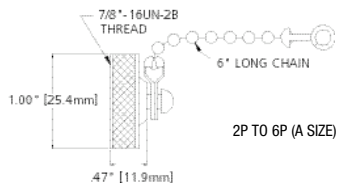

FIG. 1

ALUMINUM CLOSURE CAPS W/ EXTERNAL THREADS

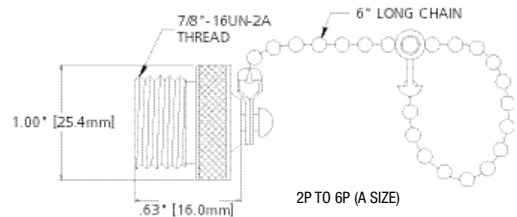

FIG. 2

THREADED UNIONS FOR MATING (2) CORDSETS

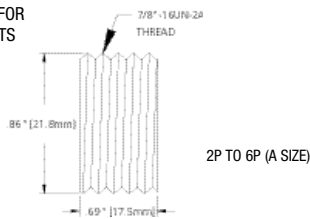

FIG. 3

FEMALE & MALE CONNECTORS FOR 1/2" LIQUID TIGHT CONDUIT W/ #16 AWG PVC LEADS 6'

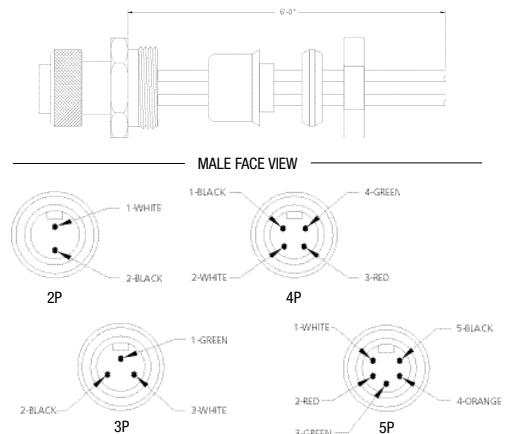

FIG. 4

90° ADAPTER

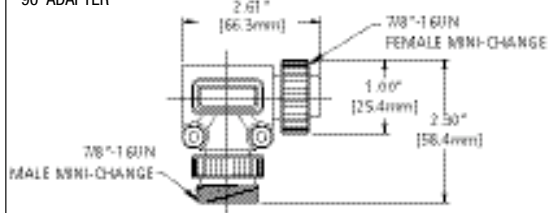

FIG. 5



**MINI-CHANGE® RECEPTACLE CATALOG NUMBER MATRIX**

Use these Catalog Number Matrices to generate a custom or existing part number. From each grouping of specifications choose the corresponding code to create a single 13 character alpha/numeric part number for ordering. Below is an example of a properly constructed Receptacle part number and how it translates to an actual part.

1R3006A20A1201

3 pole male straight receptacle with 12" leads, 16 AWG, PVC, U.S. color code, optional stainless steel shell

**1R 3 006 A20 A 120 1**

**LENGTH**

1ST DIGIT 10 x LENGTH  
2ND DIGIT 1 x LENGTH  
3RD DIGIT .1 x LENGTH

**UNIT OF MEASURE**

A INCHES  
F FEET

NOTE: USE FEET FOR LENGTH GREATER THAN 12 INCHES

**WIRE TYPE**

A16 18 AWG PVC UL 1015 IEC DC COLOR CODE 4P  
A17 18 AWG PVC UL 1061 AUTO COLOR CODE 3P-5P  
A20 16 AWG PVC UL 1015 U.S. COLOR CODE 2P-12P  
A24 16 AWG PVC UL 1015 AUTO COLOR CODE 3P & 5P  
A25 18 AWG PVC UL 1015 IEC AC COLOR CODE 3P & 5P

**RECEPTACLE TYPE**

004 FEMALE STRAIGHT, 1/2" - 14NPT MOUNTING THREAD  
005 FEMALE 90°, 1/2" - 14NPT MOUNTING THREAD 2-6 POLE A-SIZE ONLY  
006 MALE STRAIGHT, 1/2" - 14NPT MOUNTING THREAD  
007 MALE 90°, 1/2" - 14NPT MOUNTING THREAD 2-6 POLE A-SIZE ONLY  
D06 MALE STRAIGHT, PG13.5 MOUNTING THREAD, 3-5 POLE ONLY  
G04 FEMALE STRAIGHT FLANGE MOUNT 2-6 POLE A-SIZE ONLY  
G06 MALE STRAIGHT FLANGE MOUNT 2-6 POLE A-SIZE ONLY

**NUMBER OF POLES**

X 2-9 POLE  
1 10 POLE C-SIZE ONLY  
2 12 POLE C-SIZE ONLY

**PRODUCT FAMILY**

FIRST CHARACTER

1 2 TO 6 POLE (A-SIZE)  
2 6 TO 8 POLE (B-SIZE)  
3 9, 10, 12 POLE (C-SIZE)

SECOND CHARACTER

R RECEPTACLE

**OPTIONAL SHELL MATERIAL (FOR RECEPTACLE TYPE 004 AND 006 ONLY)**

BLANK

1 ZINC DIECAST, EPOXY COAT  
STAINLESS STEEL, TYPE 303  
2 NON-METALLIC NYLON 6/6  
(2P - 6P, A-SIZE ONLY)

MINI-CHANGE® CORDSET CATALOG NUMBER MATRIX

Below is an example of a properly constructed Connector part number and how it translates to an actual part.

113020A01F2001

Mini-Change 3 pole female straight to male straight double-ended cordset with 20' of 16 AWG, ST00W-A, U.S. color code, stainless steel coupling nut

11 3 020 A01 F 200 1

| PRODUCT FAMILY FIRST CHARACTER       | PRODUCT FAMILY SECOND CHARACTER   | NUMBER OF POLES     | CONNECTOR TYPE       | CABLE TYPE                                 | UNIT OF MEASURE | LENGTH      | COUPLING NUT                                  |
|--------------------------------------|-----------------------------------|---------------------|----------------------|--|-----------------|-------------|---|
| 1                                    | 2                                 | 3                   | 020                  | A01  | F               | 20          | 1   |
| 2 TO 6 POLE 1" COUPLER A-SIZE        | 6 TO 8 POLE 1 1/4" COUPLER B-SIZE | 2-9 POLE            | SINGLE-ENDED CORDSET | 16 AWG TYPE ST00W U.S. COLOR CODE 2P-12P   | FEET            | 10 x LENGTH | ZINC DIECAST, EPOXY COAT                      |
| 9, 10, 12 POLE 1 1/4" COUPLER C-SIZE |                                   | 10 POLE C-SIZE ONLY | DOUBLE-ENDED CORDSET | 16 AWG TYPE ST00W AUTO COLOR CODE 3P&5P    |                 | 1 x LENGTH  | STAINLESS STEEL, TYPE 303                     |
|                                      |                                   | 12 POLE C-SIZE ONLY |                      | 18 AWG PVC JACKET AUTO COLOR CODE 3P-5P    |                 | .1 x LENGTH | NON-METALLIC NYLON 6/6 (2P - 6P, A-SIZE ONLY) |
|                                      |                                   |                     |                      | 18 AWG PVC JACKET IEC DC COLOR CODE 4P     |                 |             |   |
|                                      |                                   |                     |                      | 18 AWG PVC JACKET IEC AC COLOR CODE 3P     |                 |             |   |
|                                      |                                   |                     |                      | 20 AWG PVC JACKET IEC AC COLOR CODE 5P     |                 |             |   |
|                                      |                                   |                     |                      | 18 AWG PUR COIL CORD AUTO COLOR CODE 3P&5P |                 |             |   |
|                                      |                                   |                     |                      | 16 AWG TYPE S00 AUTO COLOR CODE 3P-5P      |                 |             |   |
|                                      |                                   |                     |                      | 18 AWG TPE JACKET AUTO COLOR CODE 3P&5P    |                 |             |   |
|                                      |                                   |                     |                      |  |                 |             |   |

# BRAD HARRISON® PASSIVE MEDIA

## MICRO-CHANGE® SINGLE KEY M12 CORDSETS/ RECEPTACLES

- #22 AWG yellow PVC cables – DC color code
- Oil-resistant PVC jacket for all types of heavy-duty industrial environments
- Highly reliable low-resistance contact design with gold over nickel plating



### Single-Ended Cordsets

|                         | 3P   | 4P  | 5P  |
|-------------------------|--|---|---|
| <b>FEMALE FACE VIEW</b> |  |   |   |
| <b>COLOR CODES</b>      | 1 – BROWN<br>2 – NOT USED<br>3 – BLUE<br>4 – BLACK<br>5 – NOT USED | 1 – BROWN<br>2 – WHITE<br>3 – BLUE<br>4 – BLACK<br>5 – NOT USED | 1 – BROWN<br>2 – WHITE<br>3 – BLUE<br>4 – BLACK<br>5 – GRAY |
| <b>VOLTAGE</b>          | 250VAC/DC  | 250VAC/DC   | 250VAC/DC   |
| <b>CURRENT</b>          | 4A   | 4A  | 4A  |
| <b>CONDUCTOR</b>        | #22-3  | #22-4   | #22-5   |

### Female Single-Ended Cordsets with 2 meters of #22 AWG PVC cable

| CONFIGURATION                   | 3P            | 4P            | 5P            |
|---------------------------------|---------------|---------------|---------------|
| STRAIGHT (FIG. 1)               | 803000A09M020 | 804000A09M020 | 805000A09M020 |
| 90° (FIG. 2)                    | 803001A09M020 | 804001A09M020 | 805001A09M020 |
| MATING MALE RECEPTACLE (FIG. 5) | 8R3006A18A120 | 8R4006A18A120 | 8R5006A18A120 |

### Male Single-Ended Cordsets with 2 meters of #22 AWG PVC cable

| CONFIGURATION                     | 3P            | 4P            | 5P            |
|-----------------------------------|---------------|---------------|---------------|
| STRAIGHT (FIG. 3)                 | 803006A09M020 | 804006A09M020 | 805006A09M020 |
| 90° (FIG. 4)                      | 803007A09M020 | 804007A09M020 | 805007A09M020 |
| MATING FEMALE RECEPTACLE (FIG. 6) | 8R3A00A18A120 | 8R4A00A18A120 | 8R5A00A18A120 |

### Female/Male Double-Ended Cordsets with 2 meters of #22 AWG PVC cable

| CONFIGURATION                | 3P            | 4P            | 5P            |
|------------------------------|---------------|---------------|---------------|
| STRAIGHT/STRAIGHT (FIG. 1/3) | 883030A09M020 | 884030A09M020 | 885030A09M020 |
| 90°/STRAIGHT (FIG. 2/3)      | 883031A09M020 | 884031A09M020 | 885031A09M020 |
| STRAIGHT/90° (FIG. 1/4)      | 883032A09M020 | 884032A09M020 | 885032A09M020 |
| 90°/90° (FIG. 2/4)           | 883033A09M020 | 884033A09M020 | 885033A09M020 |

Options: Use the following chart to modify your part's specifications.

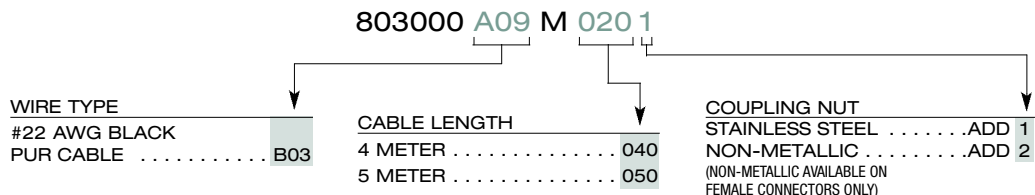

MOST WOODHEAD PRODUCTS HAVE U.L. AND/OR CSA APPROVALS. FOR A LISTING OF APPROVALS BY PART NUMBER, SEE PAGES 262-269.

**SPECIFICATIONS**

- MECHANICAL**  
 CONNECTOR FACE: NYLON 6/6  
 MOLDED BODY: PVC  
 O-RING: NITRILE RUBBER  
 COUPLING NUT: ZINC DIECAST W/ BLACK EPOXY COAT, OPTIONAL STAINLESS STEEL TYPE 303 OR NON-METALLIC BLACK DELRIN  
 CABLE: YELLOW #22 AWG PVC JACKET AND PVC CONDUCTOR INSULATION OVER 26 X #36 COPPER STRANDING, 300V, UL STYLE 2661, CSA AWM I/II A/B, OPTIONAL 80% METALLIC BRAID  
 OUTSIDE DIAMETER: WITHOUT BRAID    WITH BRAID  
 3P - 0.18" (4.6mm)    3P - 0.23" (5.8mm)  
 4P - 0.20" (5.1mm)    4P - 0.25" (6.4mm)  
 5P - 0.23" (5.8mm)    5P - 0.26" (6.6mm)
- ELECTRICAL**  
 VOLTAGE RATING: 250 VAC/DC  
 AMPERAGE: 3P - 4A  
 4P - 4A  
 5P - 4A
- ENVIRONMENTAL**  
 PROTECTION: IP 68, NEMA 6P  
 AMBIENT OPERATING TEMP: -4 TO 221° F (-20 TO 105° C)

**Connector Dimensions**

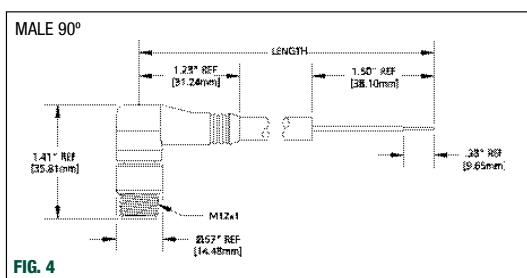
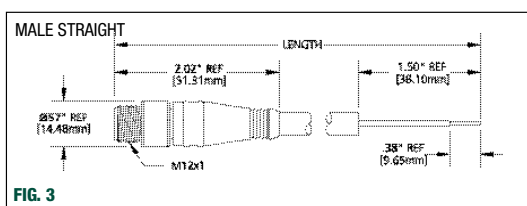
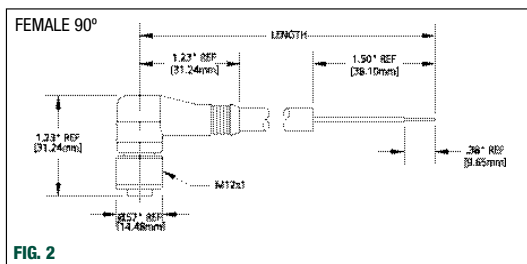
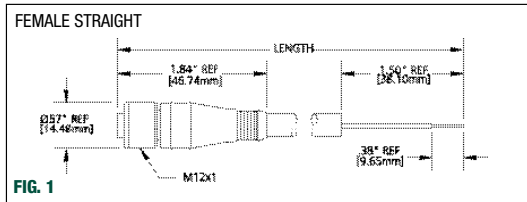

**Receptacle Dimensions**

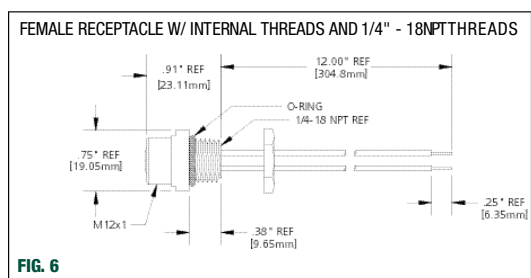
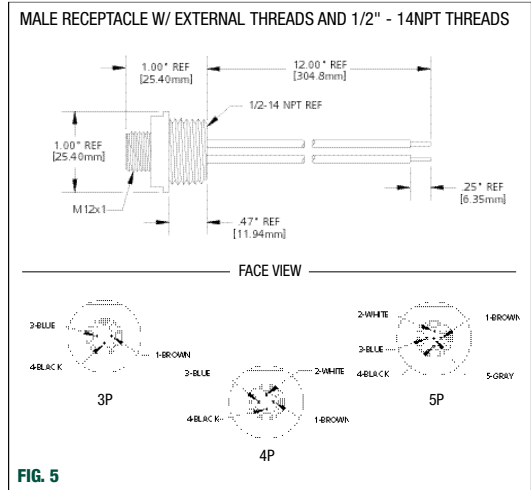

## MICRO-CHANGE® SINGLE KEY M12 CONNECTORS/ RECEPTACLES

- Secure screw terminal connection accepts up to #18 AWG conductors
- Easy field conversion to quick-disconnect design
- For use with all standard single key M12 receptacles and cordsets



### Field-Attachable Connectors Single key M12

|                         | 4P            | 5P          |
|-------------------------|---------------|-------------|
| <b>FEMALE FACE VIEW</b> |               |             |
| <b>MALE FACE VIEW</b>   |               |             |
| <b>VOLTAGE</b>          | 250VAC/300VDC | 30VAC/36VDC |
| <b>CURRENT</b>          | 4A            | 4A          |

### Female Connectors PG 7 cable fitting (0.098 - 0.26" OD [2.5 - 6.5mm] cable)

| CONFIGURATION                   | 4P            | 5P            |
|---------------------------------|---------------|---------------|
| STRAIGHT (FIG. 1)               | 8A4000-31     | 8A5000-31     |
| 90° (FIG. 2)                    | 8A4001-31     | 8A5001-31     |
| MATING MALE RECEPTACLE (FIG. 3) | 8R4006A18A120 | 8R5006A18A120 |

### Female Connectors PG 9 cable fitting (0.16 - 0.32" OD [4.1 - 8.1mm] cable)

| CONFIGURATION                   | 4P            | 5P            |
|---------------------------------|---------------|---------------|
| STRAIGHT (FIG. 1)               | 8A4000-32     | 8A5000-32     |
| MATING MALE RECEPTACLE (FIG. 3) | 8R4006A18A120 | 8R5006A18A120 |

### Male Connectors PG 7 cable fitting (0.098 - 0.26" OD [2.5 - 6.5mm] cable)

| CONFIGURATION                     | 4P            | 5P            |
|-----------------------------------|---------------|---------------|
| STRAIGHT (FIG. 4)                 | 8A4006-31     | 8A5006-31     |
| 90° (FIG. 5)                      | 8A4007-31     | 8A5007-31     |
| MATING FEMALE RECEPTACLE (FIG. 6) | 8R4A00A18A120 | 8R5A00A18A120 |

### Male Connectors PG 9 cable fitting (0.16 - 0.32" OD [4.1 - 8.1mm] cable)

| CONFIGURATION                     | 4P            | 5P            |
|-----------------------------------|---------------|---------------|
| STRAIGHT (FIG. 4)                 | 8A4006-32     | 8A5006-32     |
| MATING FEMALE RECEPTACLE (FIG. 6) | 8R4A00A18A120 | 8R5A00A18A120 |

### Closure Caps

| CONFIGURATION                              | 4P    | 5P    |
|--|-------|-------|
| METALLIC CLOSURE CAP WITH INT. THREADS     | 80011 | 80011 |
| METALLIC CLOSURE CAP WITH EXT. THREADS     | 80015 | 80015 |
| NON-METALLIC CLOSURE CAP WITH EXT. THREADS | 80013 | 80013 |



MOST WOODHEAD PRODUCTS HAVE U.L. AND/OR CSA APPROVALS.  
FOR A LISTING OF APPROVALS BY PART NUMBER, SEE PAGES 262-269.

**SPECIFICATIONS**

|                         |  |
|-------------------------|--|
| <b>MECHANICAL</b>       |  |
| CONNECTOR FACE:         | POLYAMIDE  |
| MOLDED BODY:            | POLYAMIDE  |
| CONTACT:                | SILVER PLATED BRASS                              |
| COUPLING NUT:           | NICKEL PLATED BRASS                              |
| GROMMET:                | NITRILE RUBBER                                   |
| MAXIMUM CONDUCTOR SIZE: | 18 AWG   |
| <b>ELECTRICAL</b>       |  |
| VOLTAGE RATING:         | 4P - 250VAC      300VDC<br>5P - 30VAC      36VDC |
| AMPERAGE:               | 4P - 4A<br>5P - 4A                               |
| <b>ENVIRONMENTAL</b>    |  |
| PROTECTION:             | IP 68  |
| AMBIENT OPERATING TEMP: | -13 TO 194° F (-25 TO 90 °C)                     |

**Connector Dimensions**

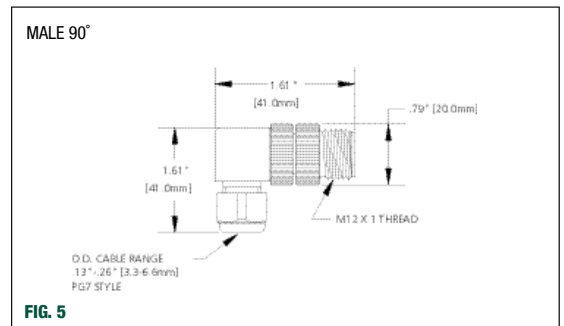
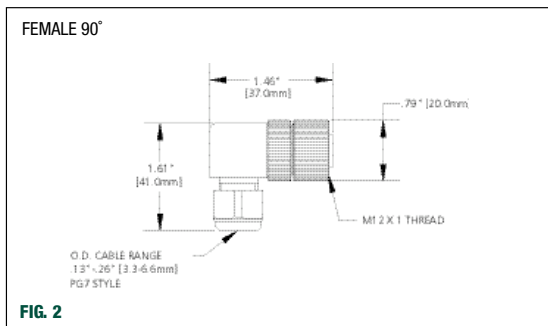
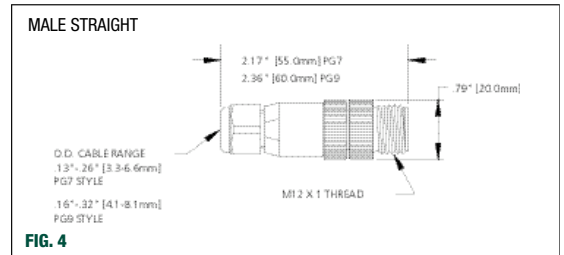
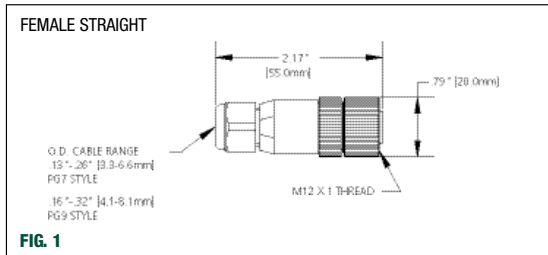

**Receptacle Dimensions**

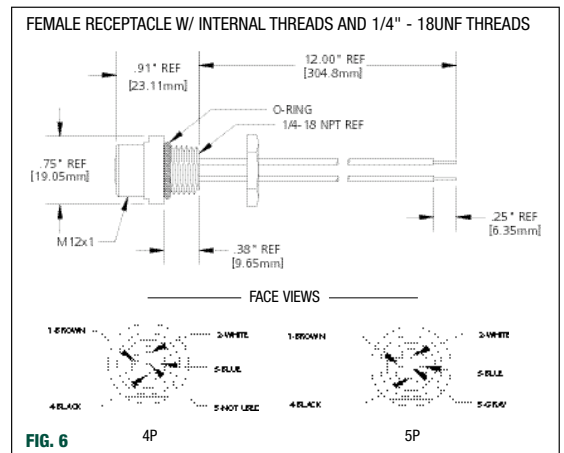
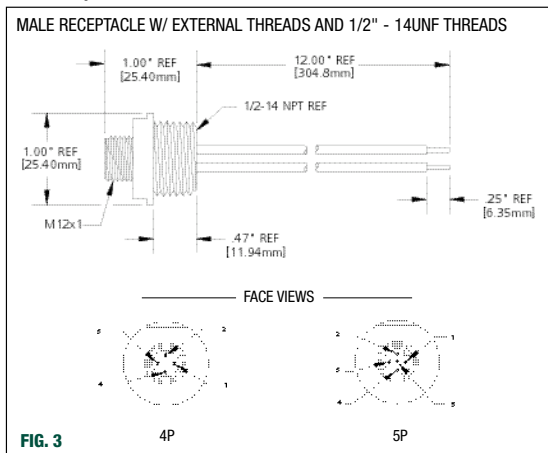

**MICRO-CHANGE® RECEPTACLE CATALOG NUMBER MATRIX**

Below is an example of a properly constructed receptacle part number and how it translates to an actual part.

**8R3006A18A1201**

Micro-Change single key, 3 pole male straight receptacle, 1/2"-14 NPT mounting threads with 12 inch leads, 22 AWG, PVC, DC color code, with stainless steel shell.

**8R 3 006 A18 A 120 1**

|                                |       |   |                        |                           |                           |               |           |             |
|--------------------------------|-------|---|------------------------|---------------------------|---------------------------|---------------|-----------|-------------|
| <b>PRODUCT FAMILY</b>          | 7R    | DUAL KEY, 1/2"-20 UNF MATING THREAD                               | <b>UNIT OF MEASURE</b> | A                         | INCHES                    | <b>LENGTH</b> | 1ST DIGIT | 10 x LENGTH |
|                                | 8R    | SINGLE KEY, M12 MATING THREAD                                     |                        | F                         | FEET (DUAL-KEY ONLY)      |               | 2ND DIGIT | 1 x LENGTH  |
| <b>NUMBER OF POLES</b>         | X     | 2-6 POLE AVAILABLE FOR DUAL KEY                                   | M                      | METERS (SINGLE-KEY ONLY)  | 3RD DIGIT                 | .1 x LENGTH   |           |             |
|                                |       | 3-5 POLE AVAILABLE FOR SINGLE KEY                                 |                        |                           |                           |               |           |             |
| <b>RECEPTACLE TYPE</b>         | 006   | MALE STRAIGHT 1/2"-14 NPT MOUNTING THREADS, SINGLE AND DUAL KEY   | <b>WIRE TYPE</b>       | DUAL KEY                  |                           |               |           |             |
|                                | A06   | MALE STRAIGHT 1/4"-18 NPT MOUNTING THREADS, DUAL KEY ONLY         |                        | A17                       | 18 AWG, PVC AC COLOR CODE |               |           |             |
|                                | E06   | MALE STRAIGHT M 14 X 1 MOUNTING THREADS, SINGLE KEY ONLY          | A19                    | 22 AWG, PVC AC COLOR CODE |                           |               |           |             |
|                                | A00   | FEMALE STRAIGHT 1/4"-18 NPT MOUNTING THREADS, SINGLE AND DUAL KEY | SINGLE KEY             |                           |                           |               |           |             |
|                                | B00   | FEMALE STRAIGHT BACK PANEL MOUNT, SINGLE AND DUAL KEY             | A16                    | 18 AWG, PVC DC COLOR CODE |                           |               |           |             |
|                                |       |   | A18                    | 22 AWG, PVC DC COLOR CODE |                           |               |           |             |
| <b>OPTIONAL SHELL MATERIAL</b> | BLANK | STANDARD MATERIAL   |                        |                           |                           |               |           |             |
|                                | 1     | STAINLESS STEEL   |                        |                           |                           |               |           |             |



MICRO-CHANGE® CORDSET CATALOG NUMBER MATRIX

Below is an example of a properly constructed receptacle part number and how it translates to an actual part.

**803000A09M020**

Micro-Change single key M12 3 pole female straight single-ended cordset,  
2 meters of 22 AWG PVC cable with DC color code, with stainless steel shell.

**80 3 000 A09 M 020 1**

| PRODUCT FAMILY CHARACTER | FIRST CHARACTER                     | SECOND CHARACTER | NUMBER OF POLES                | CORDSET TYPE | WIRE TYPE   | UNIT OF MEASURE                       |   | LENGTH      | COUPLING NUT | ADDITIONAL CHARACTER            |     |                                     |     |   |   |                 |
|--------------------------|-------------------------------------|------------------|--------------------------------|--------------|---|---------------------------------------|---|-------------|--------------|---------------------------------|-----|-------------------------------------|-----|---|---|-----------------|
|                          |                                     |                  |                                |              |   | F                                     | M |             |              |                                 |     |                                     |     |   |   |                 |
| 7                        | DUAL KEY, 1/2"-20 UNF MATING THREAD | 8                | SINGLE KEY, M12 MATING THREAD  | 000          | FEMALE: INTERNAL THREADS<br>MALE: EXTERNAL THREADS<br>SINGLE-ENDED CORDSET<br>FEMALE STRAIGHT | DUAL KEY 1/2"-20 UNF                  | F | 10 x LENGTH | BLANK        | STANDARD MATERIAL               |     |                                     |     |   |   |                 |
|                          |                                     |                  |                                |              |   |                                       |   |             |              |                                 | S00 | FEMALE STRAIGHT 360° SHIELD         | M   | 1 x LENGTH  | 1 | STAINLESS STEEL |
|                          |                                     |                  |                                |              |   |                                       |   |             |              |                                 |     |                                     |     |   |   |                 |
| 0                        | SINGLE-ENDED CORDSET                | 7                | DOUBLE-ENDED CORDSET, DUAL KEY | 006          | MALE STRAIGHT   | SINGLE KEY M12                        | M | 1 x LENGTH  | 030          | FEMALE STRAIGHT - MALE STRAIGHT |     |                                     |     |   |   |                 |
|                          |                                     |                  |                                |              |   |                                       |   |             |              |                                 | S06 | MALE STRAIGHT 360° SHIELD (SK ONLY) | S30 | FEMALE STRAIGHT - MALE STRAIGHT 360° SHIELD (SK ONLY) |   |                 |
|                          |                                     |                  |                                |              |   |                                       |   |             |              |                                 | S07 | MALE 90°                            | S31 | FEMALE 90° - MALE STRAIGHT                            |   |                 |
| 8                        | DOUBLE-ENDED CORDSET, SINGLE KEY    | 0                | DOUBLE-ENDED CORDSET, DUAL KEY | 007          | FEMALE STRAIGHT LED NPN   | 22 AWG PVC, AUTO COLOR CODE 3P AND 5P | F | 10 x LENGTH | 032          | FEMALE STRAIGHT - MALE 90°      |     |                                     |     |   |   |                 |
|                          |                                     |                  |                                |              |   |                                       |   |             |              |                                 | 001 | FEMALE 90°                          | S32 | FEMALE STRAIGHT - MALE 90° 360° SHIELD (SK ONLY)      |   |                 |
|                          |                                     |                  |                                |              |   |                                       |   |             |              |                                 | S01 | FEMALE STRAIGHT 360° SHIELD         | S33 | FEMALE 90° - MALE 90°                                 |   |                 |
|                          |                                     |                  |                                | 009          | MALE STRAIGHT LED PNP   | 18 AWG PVC, DC COLOR CODE 3P TO 5P    | M | 1 x LENGTH  | 034          | FEMALE STRAIGHT - MALE 90°      |     |                                     |     |   |   |                 |
|                          |                                     |                  |                                |              |   |                                       |   |             |              |                                 | 006 | MALE STRAIGHT                       | S34 | FEMALE 90° - MALE 90°                                 |   |                 |
|                          |                                     |                  |                                |              |   |                                       |   |             |              |                                 | S06 | MALE STRAIGHT 360° SHIELD (SK ONLY) | S35 | FEMALE 90° - MALE 90°                                 |   |                 |
|                          |                                     |                  |                                | 010          | FEMALE 90° LED NPN  | 22 AWG PVC, DC COLOR CODE 3P AND 4P   | M | 1 x LENGTH  | 036          | FEMALE STRAIGHT - MALE 90°      |     |                                     |     |   |   |                 |
|                          |                                     |                  |                                |              |   |                                       |   |             |              |                                 | 011 | FEMALE 90° LED PNP                  | S36 | FEMALE 90° - MALE 90°                                 |   |                 |
|                          |                                     |                  |                                |              |   |                                       |   |             |              |                                 | OP1 | FEMALE 90° LED PNP                  | S37 | FEMALE 90° LED PNP - MALE 90°                         |   |                 |
|                          |                                     |                  |                                | 012          | FEMALE 90° LED PNP  | 22 AWG PVC, DC COLOR CODE 3P AND 4P   | M | 1 x LENGTH  | 038          | FEMALE STRAIGHT - MALE 90°      |     |                                     |     |   |   |                 |
|                          |                                     |                  |                                |              |   |                                       |   |             |              |                                 | 013 | FEMALE 90° LED PNP                  | S38 | FEMALE 90° - MALE 90°                                 |   |                 |
|                          |                                     |                  |                                |              |   |                                       |   |             |              |                                 | OP2 | FEMALE 90° LED PNP                  | S39 | FEMALE 90° LED PNP - MALE 90°                         |   |                 |
|                          |                                     |                  |                                | 014          | FEMALE 90° LED PNP  | 22 AWG TPE, DC COLOR CODE 3P AND 5P   | M | 1 x LENGTH  | 040          | FEMALE STRAIGHT - MALE 90°      |     |                                     |     |   |   |                 |
|                          |                                     |                  |                                |              |   |                                       |   |             |              |                                 | 015 | FEMALE 90° LED PNP                  | S40 | FEMALE 90° - MALE 90°                                 |   |                 |
|                          |                                     |                  |                                |              |   |                                       |   |             |              |                                 | K02 | 18 AWG TPE, DC COLOR CODE 3P AND 5P | S41 | FEMALE 90° - MALE 90°                                 |   |                 |

## NANO-CHANGE® M8 CORDSETS/ RECEPTACLES

- #24 AWG yellow PVC cable
- Oil-resistant high-flex PUR jacket available
- Threaded coupling to withstand harsh industrial environments



### Single and Double-Ended Cordsets Threaded couplers

|                         | 3P   | 4P  | 5P  |
|-------------------------|--|---|---|
| <b>FEMALE FACE VIEW</b> |  |   |   |
| <b>COLOR CODES</b>      | 1 – BROWN<br>2 – NOT USED<br>3 – BLUE<br>4 – BLACK | 1 – BROWN<br>2 – WHITE<br>3 – BLUE<br>4 – BLACK | 1 – BROWN<br>2 – WHITE<br>3 – BLUE<br>4 – BLACK<br>5 – GRAY |
| <b>VOLTAGE</b>          | 60VAC/75VDC  | 60VAC/75VDC                                     | 60VAC/75VDC   |
| <b>CURRENT</b>          | 4A   | 4A  | 3A  |
| <b>CONDUCTOR</b>        | #24-3  | #24-4   | #24-5   |

### Female Single-Ended Cordsets With 2 meters of PVC cable

| CONFIGURATION                   | 3P            | 4P            | 5P            |
|---------------------------------|---------------|---------------|---------------|
| STRAIGHT (FIG. 1)               | 403000A10M020 | 404000A10M020 | 405000A10M020 |
| 90° (FIG. 2)                    | 403001A10M020 | 404001A10M020 | 405001A10M020 |
| MATING MALE RECEPTACLE (FIG. 5) | 4R3P06A27C300 | 4R4P06A27C300 | 4R5P06A27C300 |

### Male Single-Ended Cordsets With 2 meters of PVC cable

| CONFIGURATION                     | 3P            | 4P            | 5P            |
|-----------------------------------|---------------|---------------|---------------|
| STRAIGHT (FIG. 3)                 | 403006A10M020 | 404006A10M020 | 405006A10M020 |
| 90° (FIG. 4)                      | 403007A10M020 | 404007A10M020 | 405007A10M020 |
| MATING FEMALE RECEPTACLE (FIG. 6) | 4R3P00A27C300 | 4R4P00A27C300 | 4R5P00A27C300 |

### Female/Male Double-Ended Cordsets With 2 meters of PVC cable

| CONFIGURATION                | 3P            | 4P            | 5P            |
|------------------------------|---------------|---------------|---------------|
| STRAIGHT/STRAIGHT (FIG. 1/3) | 443030A10M020 | 444030A10M020 | 445030A10M020 |
| 90°/STRAIGHT (FIG. 2/3)      | 443031A10M020 | 444031A10M020 | 445031A10M020 |
| STRAIGHT/90° (FIG. 1/4)      | 443032A10M020 | 444032A10M020 | 445032A10M020 |
| 90°/90° (FIG. 2/4)           | 443033A10M020 | 444033A10M020 | 445033A10M020 |

Options: Use the following chart to modify your part's specifications.

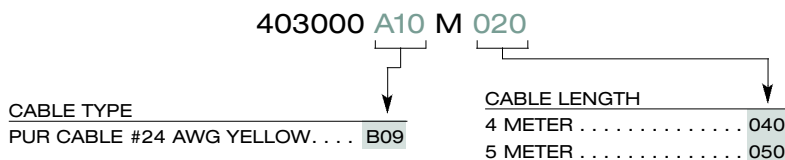

MOST WOODHEAD PRODUCTS HAVE U.L. AND/OR CSA APPROVALS. FOR A LISTING OF APPROVALS BY PART NUMBER, SEE PAGES 262-269.

SPECIFICATIONS

- MECHANICAL**  
 CONNECTOR FACE: PUR  
 MOLDED BODY: PUR  
 O-RING: VITON  
 COUPLING NUT: NICKEL-PLATED BRASS  
 CABLE: YELLOW, PVC CABLE JACKET, #24 AWG, UL STYLE 2661  
 OPTION: YELLOW, HIGH-FLEX PUR CABLE JACKET, #24 AWG, UL STYLE 20233
- |                   |               |               |
|-------------------|---------------|---------------|
| OUTSIDE DIAMETER: | PVC           | PUR           |
| 3/C               | 0.17" (4.3mm) | 0.18" (4.6mm) |
| 4/C               | 0.18" (4.6mm) | 0.18" (4.6mm) |
| 5/C               | 0.20" (5.1mm) | 0.20" (5.1mm) |
- ELECTRICAL**  
 VOLTAGE RATING: 60VAC/75VDC  
 AMPERAGE: 3P - 4A  
 4P - 4A  
 5P - 3A
- ENVIRONMENTAL**  
 PROTECTION: NEMA 6P, IP 68  
 AMBIENT OPERATING TEMP: -4-221°F (-20-105°C) - PVC  
 -4-176°F (-20-80°C) - PUR

Connector Dimensions

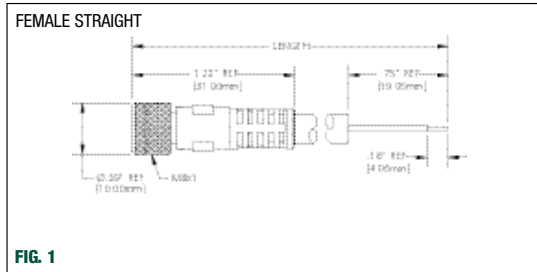

FIG. 1

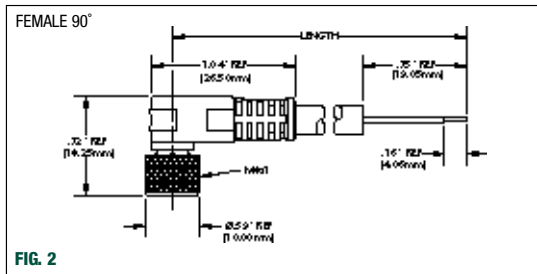

FIG. 2

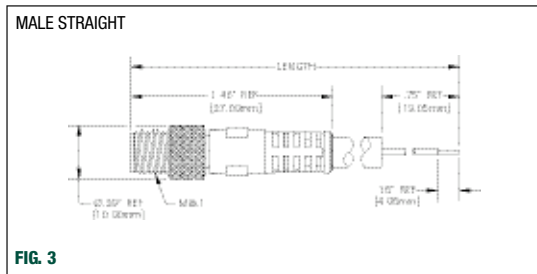

FIG. 3

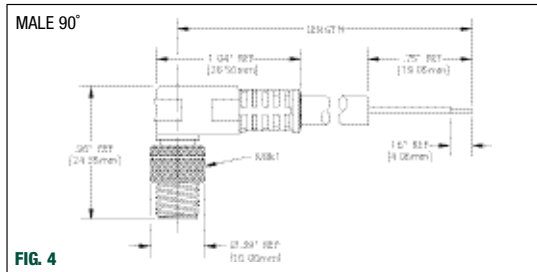

FIG. 4

Receptacle Dimensions

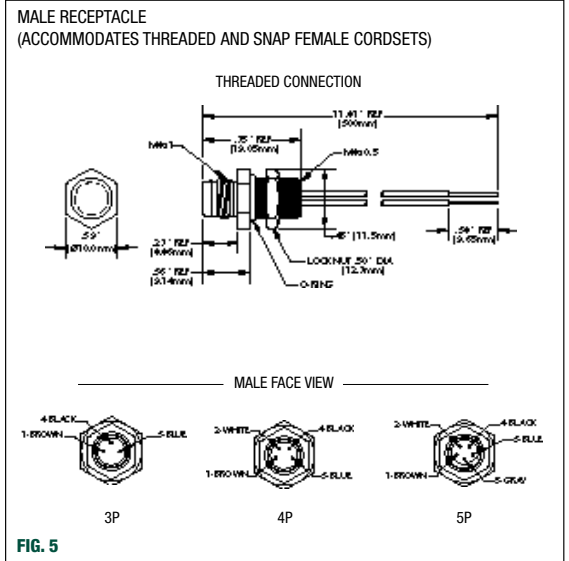

FIG. 5

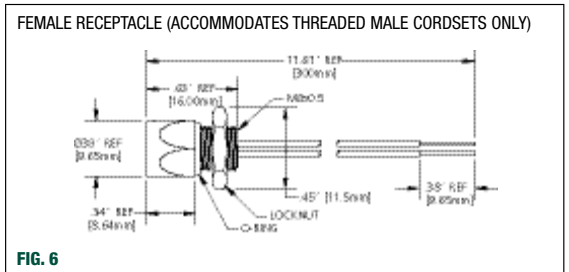

FIG. 6

## NANO-CHANGE® M8 CONNECTORS/ RECEPTACLES

- Allows easy field conversion to quick-disconnect
- Solder connections
- Male and female in both straight and 90° versions



### M8 Field-Attachable Connectors

|                         | 3P          | 5P          |
|-------------------------|-------------|-------------|
| <b>FEMALE FACE VIEW</b> |             |             |
| <b>MALE FACE VIEW</b>   |             |             |
| <b>VOLTAGE</b>          | 60VAC/75VDC | 60VAC/75VDC |
| <b>CURRENT</b>          | 4A          | 4A          |

### Female Field-Attachable Connectors 3.5-5.0mm (0.137-0.196" OD) cable fitting

| CONFIGURATION          | 3P            | 5P            |
|------------------------|---------------|---------------|
| STRAIGHT (FIG. 1)      | N03FA03124    | N04FA03124    |
| 90° (FIG. 2)           | N03FA04124    | N04FA04124    |
| MATING MALE RECEPTACLE | 4R3P06A27C300 | 4R4P06A27C300 |

### Male Field-Attachable Connectors 3.5-5.0mm (0.137-0.196" OD) cable fitting

| CONFIGURATION            | 3P            | 5P            |
|--------------------------|---------------|---------------|
| STRAIGHT (FIG. 3)        | N03MA03124    | N04MA03124    |
| 90° (FIG. 4)             | N03MA04124    | N04MA04124    |
| MATING FEMALE RECEPTACLE | 4R3P00A27C300 | 4R4P00A27C300 |



MOST WOODHEAD PRODUCTS HAVE U.L. AND/OR CSA APPROVALS.  
FOR A LISTING OF APPROVALS BY PART NUMBER, SEE PAGES 262-269.

**SPECIFICATIONS**

**MECHANICAL**  
 CONNECTOR FACE: PA  
 BODY: PA  
 COUPLING NUT: NICKEL-PLATED BRASS  
 TERMINATION: SOLDER LUGS; ACCEPTS  
 CONDUCTOR TO #20 AWG

**ELECTRICAL**  
 VOLTAGE RATING: 60VAC/75VDC  
 AMPERAGE: 4A

**ENVIRONMENTAL**  
 PROTECTION: IP 67  
 AMBIENT OPERATING TEMP: 32 TO 185° F (0 TO 85° C)

**Connector Dimensions**

FEMALE STRAIGHT W/ INTERNAL THREAD

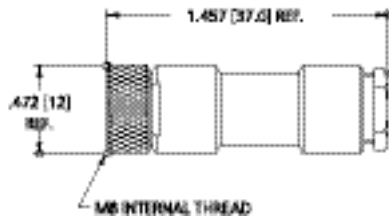

FIG. 1

MALE STRAIGHT W/ EXTERNAL THREAD

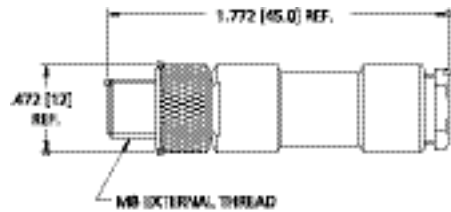

FIG. 3

FEMALE 90° W/ INTERNAL THREAD

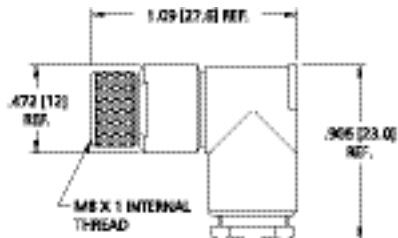

FIG. 2

MALE 90° W/ EXTERNAL THREAD

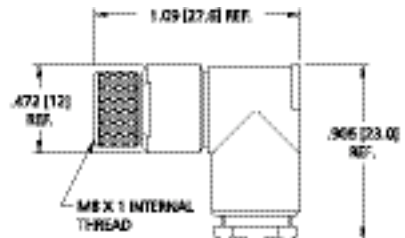

FIG. 4





NOTE: RECEPTACLE DRAWINGS ARE FOUND ON PAGE 237.

## TRUNK/FEEDER CORDSETS/ RECEPTACLES

Brad® Power cordsets for trunk and feeder circuits offer durable components for the layout of a scalable wiring system for power distribution. Available in 3 and 4 pole configurations with dual rated 10 AWG cable, Trunk/Feeder cordsets provide flexibility for electrical power applications up to 30A, 600VAC/DC. Multiple key options enable differentiated circuits on trunk/feeder lines.

Brad Power tees are key components for establishing a modular, scalable trunk and drop wiring topology. Tees with a drop connector provide an access point for branch circuits to field devices, while tees with a trunk connector split the main feeder circuit into sub-segments. Multiple key options enable differentiated circuits on trunk/feeder lines.

### Connectors

|                         | SINGLE KEY 3P   | SINGLE KEY 4P   | ALTERNATIVE KEY 3P  | ALTERNATIVE KEY 4P   |
|-------------------------|---|---|---|--|
| <b>FEMALE FACE VIEW</b> |  |  |  |  |
| <b>COLOR CODES</b>      | 1 – BLACK<br>2 – GREEN/YELLOW<br>3 – WHITE  | 1 – BLACK<br>2 – GREEN/YELLOW<br>3 – RED<br>4 – WHITE                             | 1 – BLACK<br>2 – GREEN/YELLOW<br>3 – WHITE  | 1 – BLACK<br>2 – GREEN/YELLOW<br>3 – RED<br>4 – WHITE                              |
| <b>VOLTAGE</b>          | 600VAC/VDC  | 600VAC/VDC  | 600VAC/VDC  | 600VAC/VDC   |
| <b>CURRENT</b>          | 30A   | 25A   | 30A   | 25A  |

### Female Single-Ended Cordsets with 0.5 meters of 10 AWG cable

| CONFIGURATION                       | SINGLE KEY 3P | SINGLE KEY 4P | ALTERNATIVE KEY 3P | ALTERNATIVE KEY 4P |
|-------------------------------------|---------------|---------------|--------------------|--------------------|
| STRAIGHT (FIG. 1)                   | C03000A48M010 | C04000A48M010 | C03100A48M010      | C04100A48M010      |
| 90° (FIG. 2)                        | C03001A48M010 | C04001A48M010 | C03101A48M010      | C04101A48M010      |
| 1/2-NPT MATING MALE RECEP. (FIG. 5) | CR3006A30M003 | CR4006A30M003 | CR3106A30M003      | CR4106A30M003      |
| 3/4-NPT MATING MALE RECEP. (FIG. 5) | CR3C06A30M003 | CR4C06A30M003 | CR3D06A30M003      | CR4D06A30M003      |

### Male Single-Ended Cordsets with 0.5 meters of 10 AWG cable

| CONFIGURATION                         | SINGLE KEY 3P | SINGLE KEY 4P | ALTERNATIVE KEY 3P | ALTERNATIVE KEY 4P |
|---------------------------------------|---------------|---------------|--------------------|--------------------|
| STRAIGHT (FIG. 3)                     | C03006A48M010 | C04006A48M010 | C03106A48M010      | C04106A48M010      |
| 90° (FIG. 4)                          | C03007A48M010 | C04007A48M010 | C03107A48M010      | C04107A48M010      |
| 1/2-NPT MATING FEMALE RECEP. (FIG. 6) | CR3000A30M003 | CR4000A30M003 | CR3100A30M003      | CR4100A30M003      |
| 3/4-NPT MATING FEMALE RECEP. (FIG. 6) | CR3C00A30M003 | CR4C00A30M003 | CR3D00A30M003      | CR4D00A30M003      |

### Female/Male Double-Ended Cordsets with 0.5 meters of 10 AWG cable

| CONFIGURATION                | SINGLE KEY 3P | SINGLE KEY 4P | ALTERNATIVE KEY 3P | ALTERNATIVE KEY 4P |
|------------------------------|---------------|---------------|--------------------|--------------------|
| STRAIGHT/STRAIGHT (FIG. 1/3) | CC3030A48M010 | CC4030A48M010 | CC3130A48M010      | CC4130A48M010      |
| 90°/STRAIGHT (FIG. 2/3)      | CC3031A48M010 | CC4031A48M010 | CC3131A48M010      | CC4131A48M010      |
| STRAIGHT/90° (FIG. 1/4)      | CC3032A48M010 | CC4032A48M010 | CC3132A48M010      | CC4132A48M010      |
| 90°/90° (FIG. 2/4)           | CC3033A48M010 | CC4033A48M010 | CC3133A48M010      | CC4133A48M010      |

### Accessories tees and reducing adapters

| DESCRIPTION               | SINGLE KEY 3P | SINGLE KEY 4P | ALTERNATIVE KEY 3P | ALTERNATIVE KEY 4P |
|---------------------------|---------------|---------------|--------------------|--------------------|
| TRUNK TEES                | TC30C30-001   | TC40C40-001   | TC31C31-001        | TC41C41-001        |
| TEES WITH DROP CONNECTORS | TC30130-001   | TC40140-001   | TC31130-001        | TC41140-001        |
| REDUCERS TO FEMALE DROP   | 1C3030-001    | 1C4030-001    | 1C3130-001         | 1C4130-001         |

Options: Use the following chart to modify your part's specifications.

C03006A48M 005

| CABLE LENGTH         |     |
|----------------------|-----|
| 0.5 METERS . . . . . | 005 |
| 10 METERS . . . . .  | 100 |



MOST WOODHEAD PRODUCTS HAVE U.L. AND/OR CSA APPROVALS. FOR A LISTING OF APPROVALS BY PART NUMBER, SEE PAGES 262-269.

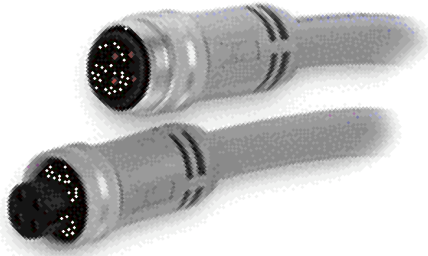

## SPECIFICATIONS

|                   |  |
|-------------------|--|
| <b>MECHANICAL</b> |  |
| CONNECTOR FACE:   | GRAY PVC   |
| BODY:             | BLACK PVC  |
| COUPLING NUT:     | ANODIZED ALUMINUM  |
| CONTACT:          | SOLID COPPER ALLOY                                       |
| CABLE:            | GRAY PVC, 10 AWG, DUAL RATED UL TC/OPEN WIRING AND ST00W |
| OUTSIDE DIAMETER: | 10/3 0.700"<br>10/4 0.755"                               |
| <b>ELECTRICAL</b> |  |
| VOLTAGE RATING:   | 600VAC/DC  |
| AMPERAGE:         | 30A (3P), 25A (4P)                                       |

## Connector Dimensions

FEMALE STRAIGHT W/ INTERNAL THREAD

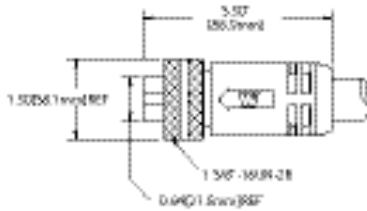

FIG. 1

MALE STRAIGHT W/ EXTERNAL THREAD

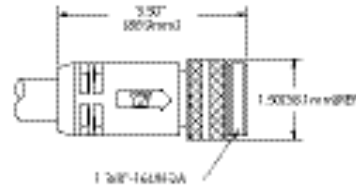

FIG. 3

FEMALE 90° W/ INTERNAL THREAD

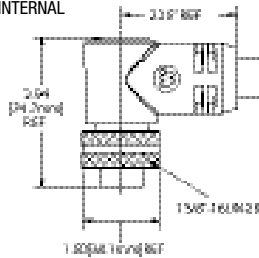

FIG. 2

MALE 90° W/ EXTERNAL THREAD

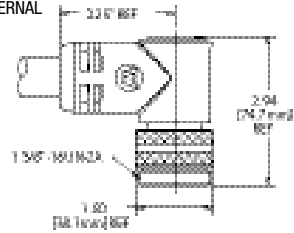

FIG. 4



## Tee and Reducer Specifications

|                    |                    |                     |                            |
|--------------------|--------------------|---------------------|----------------------------|
| <b>MECHANICAL</b>  |                    | <b>TRUNK/FEEDER</b> | <b>DROP/BRANCH</b>         |
| CONNECTOR BODY:    | GRAY PVC           | GRAY PVC            | BLACK PVC                  |
| INSERT:            | BLACK PVC          | ANODIZED ALUMINUM   | BLACK PVC                  |
| RECEPTACLE SHELL:  | ANODIZED ALUMINUM  | COPPER              | ZINC DIECAST, BLACK E-COAT |
| CONTACT:           | COPPER             |                     | GOLD OVER NICKEL-PLATED    |
| <b>ELECTRICAL</b>  |                    |                     |                            |
| VOLTAGE:           | 600VAC/DC          |                     | 600VAC/DC                  |
| MAX INPUT CURRENT: | 25A (4P), 30A (3P) |                     | -                          |
| MAX DROP CURRENT:  | 25A (4P), 30A (3P) |                     | 15A                        |

## Receptacle Dimensions (specification information on page 243)

FEMALE RECEPTACLE

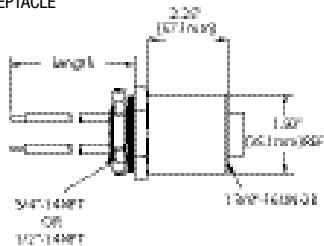

FIG. 5

MALE RECEPTACLE

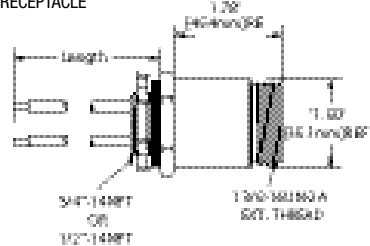

FIG. 6





## DROP/BRANCH CORDSETS/ RECEPTACLES

Brad Power cordsets for drop and branch circuits feature a compact mini style connector, which allows for the quick connection of field devices to trunk/feeder circuits. Available in 3 and 4 pole configurations with 14 or 16 AWG cable, drop/branch circuits can be wired quickly and easily for applications up to 15A, 600VAC/DC.

As the termination point at motors and devices, Brad Power receptacles offer a quick connect interface to your device or cabinet. Accessories such as closure caps maintain sealing integrity and provide convenient “stop points” for expandable power systems. Multiple key options enable differentiated circuits on trunk/feeder lines. 1/2-14NPT mounting thread.

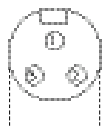
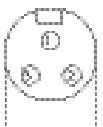
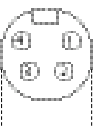
### Connectors

|                         | 3P/14 AWG   | 3P/16 AWG   | 4P/14 AWG   | 4P/16 AWG  |
|-------------------------|---|---|---|--|
| <b>FEMALE FACE VIEW</b> |  |  |  |  |
| <b>COLOR CODES</b>      | 1 – GREEN (GRND)<br>2 – BLACK<br>3 – WHITE  | 1 – GREEN (GRND)<br>2 – BLACK<br>3 – WHITE  | 1 – BLACK<br>2 – WHITE<br>3 – RED<br>4 – GREEN (GRND)                             | 1 – BLACK<br>2 – WHITE<br>3 – RED<br>4 – GREEN (GRND)                              |
| <b>VOLTAGE</b>          | 600VAC/VDC  | 600VAC/VDC  | 600VAC/VDC  | 600VAC/VDC   |
| <b>CURRENT</b>          | 30A   | 25A   | 30A   | 25A  |

### Female Single-Ended Cordsets

| CONFIGURATION                | 3P/14 AWG      | 3P/16 AWG      | 4P/14 AWG      | 4P/16 AWG      |
|------------------------------|----------------|----------------|----------------|----------------|
| STRAIGHT (FIG. 1)            | 103000A46M010  | 103000A45M010  | 104000A46M010  | 104000A45M010  |
| 90° (FIG. 2)                 | 103001A46M010  | 103001A45M010  | 104001A46M010  | 104001A45M010  |
| MATING MALE RECEPT. (FIG. 6) | 1R3006A28A120G | 1R3006A20A120G | 1R4006A28A120G | 1R4006A20A120G |

### Male Single-Ended Cordsets

| CONFIGURATION                  | 3P/14 AWG      | 3P/16 AWG      | 4P/14 AWG      | 4P/16 AWG      |
|--------------------------------|----------------|----------------|----------------|----------------|
| STRAIGHT (FIG. 3)              | 103006A46M010  | 103006A45M010  | 104006A46M010  | 104006A45M010  |
| 90° (FIG. 4)                   | 103007A46M010  | 103007A45M010  | 104007A46M010  | 104007A45M010  |
| MATING FEMALE RECEPT. (FIG. 5) | 1R3000A28A120G | 1R3000A20A120G | 1R4000A28A120G | 1R4000A20A120G |

### Female/Male Double-Ended Cordsets

| CONFIGURATION                | 3P/14 AWG     | 3P/16 AWG     | 4P/14 AWG     | 4P/16 AWG     |
|------------------------------|---------------|---------------|---------------|---------------|
| STRAIGHT/STRAIGHT (FIG. 1/3) | 113030A46M010 | 113030A45M010 | 114030A46M010 | 114030A45M010 |
| 90°/STRAIGHT (FIG. 2/3)      | 113031A46M010 | 113031A45M010 | 114031A46M010 | 114031A45M010 |
| STRAIGHT/90° (FIG. 1/4)      | 113032A46M010 | 113032A45M010 | 114032A46M010 | 114032A45M010 |
| 90°/90° (FIG. 2/4)           | 113033A46M010 | 113033A45M010 | 114033A46M010 | 114033A45M010 |

### Receptacles and Accessories

| CONFIG.         | MOUNT. THREAD | 3P/14 AWG      | 3P/16 AWG      | 4P/14 AWG      | 4P/16 AWG      | CLOSURE CAP |
|-----------------|---------------|----------------|----------------|----------------|----------------|-------------|
| FEMALE (FIG. 5) | 1/2-14NPT     | 1R3000A28A120G | 1R3000A20A120G | 1R4000A28A120G | 1R4000A20A120G | 65-0085     |
| MALE (FIG. 6)   | 1/2-14NPT     | 1R3006A28A120G | 1R3006A20A120G | 1R4006A28A120G | 1R4006A20A120G | 65-0086     |

Options: Use the following chart to modify your part's specifications.

for cordsets **103000A46M** **005**

↓

CABLE LENGTH

|            |       |     |
|------------|-------|-----|
| 0.5 METERS | ..... | 005 |
| 10 METERS  | ..... | 100 |

for receptacles **1R3000A28A** **120** **G**

↓

CABLE LENGTH

|           |       |     |
|-----------|-------|-----|
| 1 INCH    | ..... | 010 |
| 12 INCHES | ..... | 120 |

**SPECIFICATIONS**

**MECHANICAL**

CONNECTOR FACE: GRAY PVC  
 BODY: BLACK PVC  
 COUPLING NUT: ZINC DIECAST WITH BLACK EPOXY COATING  
 CONTACT: COPPER ALLOY WITH GOLD OVER NICKEL PLATING  
 CABLE: GRAY PVC, 14 AWG AND 16 AWG, DUAL RATED UL TC/OPEN WIRING AND STOOW  
 OUTSIDE DIAMETER: 14/3 0.555", 14/4 0.585", 16/3 0.395", 16/4 0.430"

**ELECTRICAL**

VOLTAGE RATING: 600VAC/DC  
 AMPERAGE: 10A (16 AWG), 15A (14 AWG)

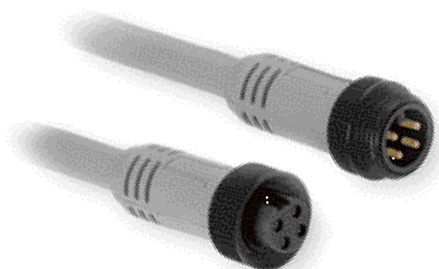

**Connector Dimensions**

**FEMALE STRAIGHT W/ INTERNAL THREAD**

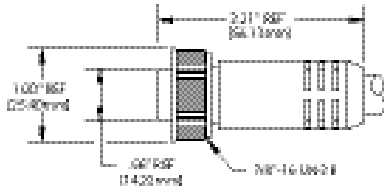

**FIG. 1**

**MALE STRAIGHT W/ EXTERNAL THREAD**

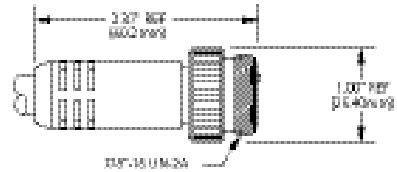

**FIG. 3**

**FEMALE 90° W/ INTERNAL THREAD**

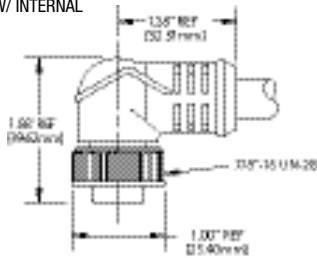

**FIG. 2**

**MALE 90° W/ EXTERNAL THREAD**

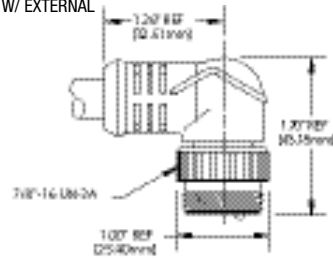
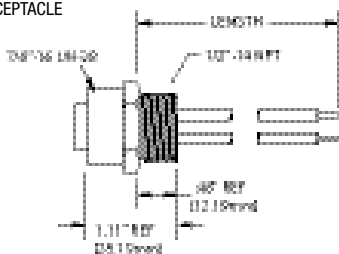

**FIG. 4**



**Receptacle Dimensions**

**FEMALE RECEPTACLE**



**FIG. 5**

**MALE RECEPTACLE**

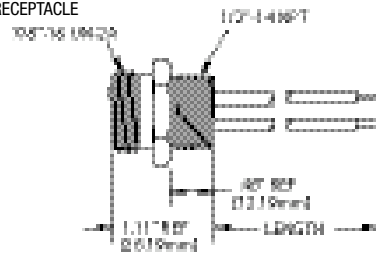

**FIG. 6**

**Receptacle Specifications**

**MECHANICAL DROP/BRANCH**

INSERT: BLACK PVC  
 RECEPTACLE SHELL: ZINC-DIECAST, BLACK E-COAT  
 CONTACT: GOLD OVER NICKEL PLATED  
 WIRE INSULATION: PVC  
 WIRE GAUGE: 14AWG AND 16AWG

**ELECTRICAL**

AMPERAGE: 10A/600V (16AWG)  
 13A/600V (14AWG)

**TRUNK/FEEDER**

BLACK PVC  
 ANODIZED ALUMINUM  
 COPPER ALLOY  
 PVC  
 10AWG

25A/600V (4P)  
 30A/600V (3P)

## COMPETITIVE COMPARISON CROSS REFERENCE - CABLE GRIPS

| COMPARISON NO. | WOODHEAD NO. | COMPARISON NO. | WOODHEAD NO. | COMPARISON NO. | WOODHEAD NO. | COMPARISON NO. | WOODHEAD NO. |
|----------------|--------------|----------------|--------------|----------------|--------------|----------------|--------------|
| 003-22-001     | 5601         | 022-02-010     | 35143        | 022-03-023     | 35294        | 022-16-007     | 36577        |
| 003-22-002     | 5602         | 022-02-011     | 35144        | 022-03-024     | 35295        | 022-16-008     | 36577        |
| 003-22-003     | 5603         | 022-02-012     | 35145        | 022-03-037     | 35300        | 022-16-009     | 36578        |
| 003-22-004     | 5604         | 022-02-013     | 35165        | 022-03-038     | 35301        | 022-16-010     | 36578        |
| 022-01-001     | 35001        | 022-02-014     | 35166        | 022-03-039     | 35302        | 022-16-011     | 36578        |
| 022-01-002     | 35002        | 022-02-015     | 35167        | 022-03-041     | 35303        | 022-16-012     | 36578        |
| 022-01-003     | 35003        | 022-02-017     | 35168        | 022-03-042     | 35304        | 022-16-013     | 36579        |
| 022-01-005     | 35004        | 022-02-018     | 35169        | 022-03-043     | 35305        | 022-16-014     | 36579        |
| 022-01-007     | 35006        | 022-02-019     | 35170        | 022-03-044     | 35306        | 022-16-015     | 36579        |
| 022-01-008     | 35007        | 022-02-020     | 35171        | 022-03-045     | 35307        | 022-16-016     | 36581        |
| 022-01-009     | 35008        | 022-02-021     | 35172        | 022-03-046     | 35308        | 022-16-017     | 36583        |
| 022-01-010     | 35009        | 022-02-022     | 35173        | 022-03-047     | 35309        | 022-16-018     | 36583        |
| 022-01-011     | 35010        | 022-02-023     | 35174        | 022-03-048     | 35310        | 022-16-019     | 36585        |
| 022-01-012     | 35011        | 022-02-024     | 35175        | 022-03-064     | 35330        | 022-16-020     | 36585        |
| 022-01-013     | 35030        | 022-02-037     | 35195        | 022-03-065     | 35331        | 022-16-021     | 36586        |
| 022-01-014     | 35031        | 022-02-038     | 35196        | 022-03-066     | 35332        | 022-16-022     | 36586        |
| 022-01-015     | 35032        | 022-02-039     | 35197        | 022-03-068     | 35333        | 022-16-023     | 36586        |
| 022-01-017     | 35033        | 022-02-041     | 35198        | 022-03-069     | 35334        | 022-16-024     | 36588        |
| 022-01-018     | 35034        | 022-02-042     | 35199        | 022-03-070     | 35335        | 022-16-025     | 36588        |
| 022-01-019     | 35035        | 022-02-043     | 35200        | 022-03-071     | 35336        | 022-16-026     | 36588        |
| 022-01-020     | 35036        | 022-02-044     | 35201        | 022-03-072     | 35337        | 022-16-027     | 36588        |
| 022-01-021     | 35037        | 022-02-045     | 35202        | 022-03-073     | 35338        | 022-16-028     | 36590        |
| 022-01-022     | 35038        | 022-02-046     | 35203        | 022-03-074     | 35339        | 022-16-029     | 36590        |
| 022-01-023     | 35039        | 022-02-047     | 35204        | 022-03-075     | 35340        | 022-16-030     | 36590        |
| 022-01-024     | 35040        | 022-02-048     | 35205        | 022-06-001     | 35425        | 022-29-1000    | 36670        |
| 022-01-037     | 35060        | 022-02-050     | 35225        | 022-06-002     | 35426        | 022-29-1001    | 36671        |
| 022-01-038     | 35061        | 022-02-051     | 35226        | 022-06-003     | 35427        | 022-29-1002    | 36672        |
| 022-01-039     | 35062        | 022-02-052     | 35227        | 022-06-004     | 35428        | 022-29-1003    | 36673        |
| 022-01-041     | 35063        | 022-02-054     | 35228        | 022-06-005     | 35429        | 022-29-1004    | 36674        |
| 022-01-042     | 35064        | 022-02-055     | 35229        | 022-06-006     | 35430        | 022-29-1005    | 36675        |
| 022-01-043     | 35065        | 022-02-056     | 35230        | 022-06-007     | 35431        | 022-29-1006    | 36676        |
| 022-01-044     | 35066        | 022-02-057     | 35231        | 022-06-008     | 35432        | 022-29-1008    | 36690        |
| 022-01-045     | 35067        | 022-02-058     | 35232        | 022-06-009     | 35433        | 022-29-1009    | 36691        |
| 022-01-046     | 35068        | 022-02-059     | 35233        | 022-06-010     | 35435        | 022-29-1010    | 36692        |
| 022-01-047     | 35069        | 022-02-060     | 35324        | 022-06-011     | 35436        | 022-29-1011    | 36693        |
| 022-01-048     | 35070        | 022-02-061     | 35235        | 022-06-012     | 35437        | 022-29-1012    | 36694        |
| 022-01-050     | 35093        | 022-03-001     | 35270        | 022-06-013     | 35438        | 022-29-1013    | 36695        |
| 022-01-051     | 35090        | 022-03-002     | 35271        | 022-07-001     | 35440        | 022-29-1014    | 36696        |
| 022-01-052     | 35091        | 022-03-003     | 35272        | 022-07-002     | 35441        | 022-29-1016    | 36680        |
| 022-01-053     | 35092        | 022-03-005     | 35273        | 022-07-003     | 35442        | 022-29-1017    | 36681        |
| 022-01-054     | 35094        | 022-03-006     | 35274        | 022-07-004     | 35443        | 022-29-1018    | 36682        |
| 022-01-055     | 35095        | 022-03-007     | 35275        | 022-07-005     | 35444        | 022-29-1019    | 36683        |
| 022-01-056     | 35096        | 022-03-008     | 35276        | 022-07-006     | 35445        | 022-29-1020    | 36684        |
| 022-01-057     | 35097        | 022-03-009     | 35277        | 022-07-007     | 35446        | 022-29-1021    | 36685        |
| 022-01-058     | 35098        | 022-03-010     | 35278        | 022-07-008     | 35447        | 022-29-1022    | 36686        |
| 022-01-059     | 35099        | 022-03-011     | 35279        | 022-07-009     | 35448        | 033-01-001     | 35850        |
| 022-01-060     | 35100        | 022-03-012     | 35280        | 022-07-010     | 35450        | 033-01-002     | 35851        |
| 022-02-001     | 35135        | 022-03-013     | 35285        | 022-07-011     | 35451        | 033-01-011     | 35865        |
| 022-02-002     | 35136        | 022-03-014     | 35286        | 022-07-012     | 35452        | 033-01-012     | 35866        |
| 022-02-003     | 35137        | 022-03-015     | 35287        | 022-07-013     | 35453        | 033-01-013     | 35867        |
| 022-02-005     | 35138        | 022-03-017     | 35288        | 022-16-001     | 36573        | 033-01-014     | 35868        |
| 022-02-006     | 35005        | 022-03-018     | 35289        | 022-16-002     | 36575        | 033-01-016     | 35869        |
| 022-02-006     | 35139        | 022-03-019     | 35290        | 022-16-003     | 36575        | 033-01-017     | 35870        |
| 022-02-007     | 35140        | 022-03-020     | 35291        | 022-16-004     | 36576        | 033-01-018     | 35871        |
| 022-02-008     | 35141        | 022-03-021     | 35292        | 022-16-005     | 36576        | 033-01-019     | 35872        |
| 022-02-009     | 35142        | 022-03-022     | 35293        | 022-16-006     | 36577        | 033-01-020     | 35873        |

## COMPETITIVE COMPARISON CROSS REFERENCE - CABLE GRIPS

| COMPARISON NO. | WOODHEAD NO. | COMPARISON NO. | WOODHEAD NO. | COMPARISON NO. | WOODHEAD NO. | COMPARISON NO. | WOODHEAD NO. |
|----------------|--------------|----------------|--------------|----------------|--------------|----------------|--------------|
| 033-01-021     | 35874        | 033-04-1083    | 35941        | 033-10-001     | 36140        | 073-10-003     | 36552        |
| 033-01-024     | 35880        | 033-04-1084    | 35942        | 033-10-002     | 36141        | 073-10-004     | 36553        |
| 033-01-025     | 35881        | 033-04-1085    | 35943        | 033-10-003     | 36142        | 073-10-005     | 36554        |
| 033-01-026     | 35882        | 033-04-1086    | 35944        | 033-10-004     | 36143        | 073-10-006     | 36555        |
| 033-01-027     | 35883        | 033-04-1087    | 35945        | 033-10-005     | 36144        | 074-01-001     | 36430        |
| 033-01-028     | 35884        | 033-04-1088    | 35946        | 033-10-006     | 36145        | 074-01-002     | 36431        |
| 033-01-029     | 35885        | 033-04-1089    | 35947        | 033-10-007     | 36146        | 074-01-003     | 36432        |
| 033-01-030     | 35886        | 033-04-1090    | 35948        | 033-10-008     | 36147        | 074-01-004     | 36250        |
| 033-01-031     | 35887        | 033-04-1091    | 35950        | 033-10-009     | 36148        | 074-01-006     | 36251        |
| 033-01-039     | 35897        | 033-04-1092    | 35951        | 033-10-010     | 36149        | 074-01-008     | 36254        |
| 033-01-045     | 35899        | 033-04-1093    | 35952        | 033-10-011     | 36150        | 074-01-010     | 36256        |
| 033-01-047     | 35898        | 033-04-1094    | 35953        | 033-27-1037    | 36610        | 074-01-013     | 36257        |
| 033-01-1017    | 35875        | 033-04-1095    | 35954        | 033-27-1038    | 36611        | 074-01-015     | 36259        |
| 033-02-016     | 36620        | 033-04-1096    | 35955        | 033-27-1039    | 36612        | 074-01-017     | 36261        |
| 033-02-018     | 36621        | 033-04-1097    | 35956        | 033-27-1040    | 36613        | 074-01-018     | 36263        |
| 033-02-020     | 36622        | 033-05-001     | 35970        | 033-27-1041    | 36614        | 074-01-019     | 36275        |
| 033-02-022     | 36623        | 033-05-002     | 35971        | 033-27-1042    | 36615        | 074-01-020     | 36275        |
| 033-02-024     | 36624        | 033-05-003     | 35972        | 033-29-1000    | 36660        | 074-01-021     | 36265        |
| 033-02-026     | 36625        | 033-05-004     | 35973        | 033-29-1001    | 36661        | 074-01-023     | 36267        |
| 033-02-028     | 36626        | 033-05-005     | 35974        | 033-29-1002    | 36662        | 074-01-025     | 36269        |
| 033-02-044     | 36640        | 033-05-006     | 35975        | 033-29-1003    | 36663        | 074-01-026     | 36271        |
| 033-02-046     | 36641        | 033-05-114     | 35976        | 033-29-1004    | 36664        | 074-01-027     | 36272        |
| 033-02-048     | 36642        | 033-08-003     | 36101        | 033-29-1005    | 36665        | 074-01-028     | 36273        |
| 033-02-050     | 36643        | 033-08-004     | 36102        | 072-02-047     | 36405        | 074-01-029     | 36475        |
| 033-02-052     | 36644        | 033-08-005     | 36103        | 073-03-1200    | 36502        | 074-01-030     | 36476        |
| 033-02-054     | 36645        | 033-08-006     | 36104        | 073-03-1201    | 36504        | 074-01-031     | 36477        |
| 033-02-056     | 36646        | 033-08-007     | 36105        | 073-03-1202    | 36506        | 074-01-032     | 36478        |
| 033-02-066     | 36627        | 033-08-008     | 36106        | 073-03-1203    | 36509        | 074-01-033     | 36485        |
| 033-02-097     | 36628        | 033-08-009     | 36107        | 073-03-1204    | 36513        | 074-01-034     | 36486        |
| 033-02-1030    | 36629        | 033-08-010     | 36108        | 073-03-1205    | 36514        | 074-01-035     | 36487        |
| 033-02-1031    | 36630        | 033-08-011     | 36109        | 073-03-1206    | 36501        | 074-01-036     | 36433        |
| 033-02-1078    | 36647        | 033-08-012     | 36111        | 073-03-1207    | 36503        | 074-01-037     | 36434        |
| 033-02-1079    | 36648        | 033-08-013     | 36112        | 073-03-1208    | 36505        | 074-01-038     | 36435        |
| 033-02-1080    | 36649        | 033-08-014     | 36113        | 073-03-1209    | 36508        | 074-01-039     | 36280        |
| 033-02-1081    | 36650        | 033-08-015     | 36114        | 073-03-1210    | 36512        | 074-01-041     | 36282        |
| 033-03-001     | 35901        | 033-08-016     | 36115        | 073-03-1211    | 36515        | 074-01-043     | 36284        |
| 033-03-002     | 35902        | 033-08-017     | 36116        | 073-03-1212    | 36516        | 074-01-045     | 36286        |
| 033-03-003     | 35903        | 033-08-018     | 36117        | 073-03-1213    | 36517        | 074-01-048     | 36290        |
| 033-03-004     | 35904        | 033-08-019     | 36118        | 073-03-1214    | 36518        | 074-01-050     | 36292        |
| 033-03-005     | 35905        | 033-09-003     | 36120        | 073-03-1215    | 36519        | 074-01-052     | 36294        |
| 033-03-006     | 35906        | 033-09-004     | 36121        | 073-04-1276    | 36560        | 074-01-053     | 36296        |
| 033-03-007     | 35907        | 033-09-005     | 36122        | 073-04-1277    | 36562        | 074-01-054     | 36819        |
| 033-03-008     | 35908        | 033-09-006     | 36123        | 073-04-1278    | 36564        | 074-01-056     | 36298        |
| 033-03-009     | 35909        | 033-09-007     | 36124        | 073-04-1279    | 36567        | 074-01-058     | 36300        |
| 033-03-010     | 35910        | 033-09-008     | 36125        | 073-04-1280    | 36569        | 074-01-060     | 36302        |
| 033-03-011     | 35911        | 033-09-009     | 36126        | 073-04-1281    | 36571        | 074-01-061     | 36304        |
| 033-03-012     | 35912        | 033-09-010     | 36127        | 073-04-1282    | 36574        | 074-01-062     | 36305        |
| 033-03-013     | 35913        | 033-09-011     | 36128        | 073-04-1283    | 36580        | 074-01-063     | 36306        |
| 033-03-015     | 35914        | 033-09-012     | 36130        | 073-04-1284    | 36582        | 074-01-064     | 36450        |
| 033-03-016     | 35915        | 033-09-013     | 36131        | 073-04-1285    | 36584        | 074-01-065     | 36451        |
| 033-03-017     | 35916        | 033-09-014     | 36132        | 073-04-1286    | 36587        | 074-01-066     | 36452        |
| 033-03-018     | 35917        | 033-09-015     | 36133        | 073-04-1287    | 36589        | 074-01-067     | 36453        |
| 033-03-019     | 35918        | 033-09-016     | 36134        | 073-04-1288    | 36591        | 074-01-068     | 36460        |
| 033-03-020     | 35919        | 033-09-017     | 36135        | 073-04-1289    | 36594        | 074-01-069     | 36461        |
| 033-03-029     | 35919        | 033-09-018     | 36136        | 073-10-001     | 36550        | 074-01-070     | 36462        |
| 033-04-1082    | 35940        | 033-09-019     | 36137        | 073-10-002     | 36551        | 074-01-071     | 36436        |

## COMPETITIVE COMPARISON CROSS REFERENCE - CABLE GRIPS

| COMPARISON NO. | WOODHEAD NO. | COMPARISON NO. | WOODHEAD NO. | COMPARISON NO. | WOODHEAD NO. | COMPARISON NO. | WOODHEAD NO. |
|----------------|--------------|----------------|--------------|----------------|--------------|----------------|--------------|
| 074-01-072     | 36437        | 074-01-1198    | 36826        | 074-01-1270    | 36820        | 074-02-024     | 36382        |
| 074-01-073     | 36438        | 074-01-1199    | 36330        | 074-01-1271    | 36821        | 074-02-031     | 36442        |
| 074-01-074     | 36340        | 074-01-1230    | 36831        | 074-01-1272    | 36822        | 074-02-032     | 36390        |
| 074-01-076     | 36342        | 074-01-1231    | 36469        | 074-01-1273    | 36823        | 074-02-033     | 36391        |
| 074-01-078     | 36344        | 074-01-1232    | 36834        | 074-01-1274    | 36463        | 074-02-034     | 36392        |
| 074-01-080     | 36346        | 074-01-1233    | 36835        | 074-01-1331    | 5522M        | 074-02-035     | 36393        |
| 074-01-081     | 36349        | 074-01-1234    | 36500        | 074-01-1332    | 5524M/5526M  | 074-02-036     | 36394        |
| 074-01-083     | 36351        | 074-01-1235    | 36310        | 074-01-1333    | 5528M/5530M  | 074-02-037     | 36395        |
| 074-01-084     | 36353        | 074-01-1236    | 36312        | 074-01-1334    | 5532M/5534M  | 074-02-041     | 36443        |
| 074-01-085     | 36830        | 074-01-1237    | 36316        | 074-01-1335    | 5624M/5536M  | 074-02-042     | 36400        |
| 074-01-087     | 36355        | 074-01-1238    | 36319        | 074-01-1336    | 5538M        | 074-02-043     | 36401        |
| 074-01-089     | 36357        | 074-01-1241    | 36833        | 074-01-1337    | 5542M        | 074-02-044     | 36402        |
| 074-01-091     | 36359        | 074-01-1242    | 36464        | 074-01-1338    | 5544M        | 074-02-045     | 36403        |
| 074-01-1021    | 36314        | 074-01-1243    | 36307        | 074-01-1339    | 5546M        | 074-02-046     | 36404        |
| 074-01-1022    | 36332        | 074-01-1244    | 36497        | 074-01-1340    | 5548M        | 074-02-048     | 37033        |
| 074-01-1028    | 36276        | 074-01-1245    | 36498        | 074-01-1341    | 5552M        | 074-02-049     | 37034        |
| 074-01-1030    | 36800        | 074-01-1246    | 36499        | 074-01-1342    | 5556M        | 074-02-050     | 37035        |
| 074-01-1031    | 36801        | 074-01-1247    | 36245        | 074-01-1343    | 5560M        | 074-02-061     | 36443        |
| 074-01-1032    | 36802        | 074-01-1248    | 36246        | 074-01-1345    | 5523M        | 074-02-062     | 36400        |
| 074-01-1033    | 36803        | 074-01-1249    | 36248        | 074-01-1346    | 5525M/5527M  | 074-02-063     | 36401        |
| 074-01-1034    | 36804        | 074-01-1249    | 36248        | 074-01-1347    | 5529M/5531M  | 074-02-064     | 36402        |
| 074-01-1035    | 36807        | 074-01-1250    | 36270        | 074-01-1348    | 5533M/5535M  | 074-02-065     | 36403        |
| 074-01-1036    | 36808        | 074-01-1251    | 36277        | 074-01-1349    | 5625M/5537M  | 074-02-066     | 36404        |
| 074-01-1037    | 36809        | 074-01-1251    | 36277        | 074-01-1350    | 5539M        | 074-02-067     | 36405        |
| 074-01-1038    | 36810        | 074-01-1251    | 36277        | 074-01-1351    | 5543M        | 074-02-068     | 37033        |
| 074-01-1039    | 36811        | 074-01-1252    | 36278        | 074-01-1352    | 5545M        | 074-02-069     | 37034        |
| 074-01-1042    | 36363        | 074-01-1252    | 36278        | 074-01-1353    | 5547M        | 074-02-070     | 37035        |
| 074-01-1043    | 36364        | 074-01-1253    | 36479        | 074-01-1354    | 5549M        | 074-02-088     | 36442        |
| 074-01-1044    | 36470        | 074-01-1253    | 36479        | 074-01-1355    | 5553M        | 074-02-089     | 36390        |
| 074-01-1045    | 36471        | 074-01-1254    | 36480        | 074-01-1356    | 5557M        | 074-02-090     | 36391        |
| 074-01-1046    | 36472        | 074-01-1254    | 36480        | 074-01-1357    | 5561M        | 074-02-093     | 36392        |
| 074-01-1047    | 36473        | 074-01-1255    | 36481        | 074-01-137     | 36361        | 074-02-094     | 36393        |
| 074-01-1049    | 36321        | 074-01-1255    | 36481        | 074-02-001     | 36440        | 074-02-095     | 36394        |
| 074-01-1051    | 36323        | 074-01-1256    | 36482        | 074-02-002     | 36370        | 074-02-096     | 36395        |
| 074-01-1053    | 36827        | 074-01-1256    | 36482        | 074-02-003     | 36371        | 074-02-097     | 37036        |
| 074-01-1055    | 36326        | 074-01-1257    | 36483        | 074-02-004     | 36372        | 074-02-098     | 37037        |
| 074-01-1057    | 36328        | 074-01-1257    | 36483        | 074-02-005     | 36373        | 074-02-099     | 37038        |
| 074-01-1059    | 36333        | 074-01-1258    | 36484        | 074-02-006     | 36374        | 074-06-001     | 36440        |
| 074-01-1060    | 36334        | 074-01-1258    | 36484        | 074-02-007     | 36375        | 074-06-002     | 36370        |
| 074-01-1061    | 36335        | 074-01-1259    | 36279        | 074-02-008     | 37030        | 074-06-003     | 36371        |
| 074-01-1062    | 36465        | 074-01-1259    | 36279        | 074-02-009     | 37031        | 074-06-004     | 36372        |
| 074-01-1063    | 36466        | 074-01-1260    | 36488        | 074-02-010     | 37032        | 074-06-005     | 36373        |
| 074-01-1064    | 36467        | 074-01-1260    | 36488        | 074-02-011     | 36440        | 074-06-006     | 36374        |
| 074-01-1065    | 36468        | 074-01-1261    | 36489        | 074-02-012     | 36370        | 074-06-007     | 36375        |
| 074-01-108     | 36362        | 074-01-1261    | 36489        | 074-02-013     | 36371        | 074-06-008     | 37030        |
| 074-01-108     | 36362        | 074-01-1262    | 36816        | 074-02-014     | 36372        | 074-06-009     | 37031        |
| 074-01-1178    | 36274        | 074-01-1262    | 36816        | 074-02-015     | 36373        | 074-06-010     | 37032        |
| 074-01-1178    | 36274        | 074-01-1263    | 36287        | 074-02-016     | 36374        | 074-06-012     | 36370        |
| 074-01-1186    | 36812        | 074-01-1263    | 36287        | 074-02-017     | 36375        | 074-06-013     | 36371        |
| 074-01-1187    | 36813        | 074-01-1264    | 36288        | 074-02-018     | 37030        | 074-06-014     | 36372        |
| 074-01-1188    | 36814        | 074-01-1264    | 36288        | 074-02-019     | 37031        | 074-06-015     | 36373        |
| 074-01-1189    | 36815        | 074-01-1265    | 36289        | 074-02-020     | 37032        | 074-06-016     | 36374        |
| 074-01-1195    | 36249        | 074-01-1265    | 36289        | 074-02-021     | 36441        | 074-06-017     | 36375        |
| 074-01-1196    | 36818        | 074-01-1266    | 36805        | 074-02-022     | 36380        | 074-06-018     | 37030        |
| 074-01-1197    | 36829        | 074-01-1267    | 36806        | 074-02-023     | 36381        | 074-06-019     | 37031        |

## COMPETITIVE COMPARISON CROSS REFERENCE - CABLE GRIPS

| COMPARISON NO. | WOODHEAD NO. | COMPARISON NO. | WOODHEAD NO. | COMPARISON NO. | WOODHEAD NO. | COMPARISON NO. | WOODHEAD NO. |
|----------------|--------------|----------------|--------------|----------------|--------------|----------------|--------------|
| 074-06-020     | 37032        | 074-09-3402    | 36370        | 203-02-002     | 36238        | NHC-1035-CR    | 5625/5537    |
| 074-06-022     | 36441        | 074-09-3403    | 36371        | 203-03-001     | 36241        | NHC-1036-CR    | 5539         |
| 074-06-023     | 36380        | 074-09-3404    | 36372        | CG-40490-NM    | 5523NM       | NHC-1037-CR    | 5543         |
| 074-06-024     | 36381        | 074-09-3405    | 36373        | CG-404-NM      | 5522NM       | NHC-1039-CR    | 5547         |
| 074-06-025     | 36382        | 074-09-3406    | 36374        | CG-404-SST     | 5522MSS      | NHC-1040-CR    | 5549         |
| 074-06-031     | 36442        | 074-09-3408    | 36375        | CG-40690-NM    | 5527NM       | NHC-1041-CR    | 5553         |
| 074-06-032     | 36390        | 074-09-3410    | 37030        | CG406-NM       | 5526NM       | NHC-1042-CR    | 5557         |
| 074-06-033     | 36391        | 074-09-3412    | 37031        | CG-406-SST     | 5524MSS      | NHC-1043-CR    | 5561         |
| 074-06-034     | 36392        | 074-09-3416    | 37032        | CG-406-SST     | 5526MSS      | NHC-1044-CR    | 5563         |
| 074-06-035     | 36393        | 074-09-3421    | 36443        | CG-40890-NM    | 5531NM       | SHC-1001-CR    | 5398         |
| 074-06-036     | 36394        | 074-09-3422    | 36400        | CG-408-NM      | 5530NM       | SHC-1002-CR    | 5400         |
| 074-06-037     | 36395        | 074-09-3423    | 36401        | CG-408-SST     | 5528MSS      | SHC-1003-CR    | 5402         |
| 074-06-041     | 36443        | 074-09-3424    | 36402        | CG-408-SST     | 5530MSS      | SHC-1007-CR    | 5498         |
| 074-06-042     | 36400        | 074-09-3425    | 36403        | CG-410-SST     | 5532MSS      | SHC-1008-CR    | 5500         |
| 074-06-043     | 36401        | 074-09-3426    | 36404        | CG-410-SST     | 5534MSS      | SHC-1009-CR    | 5502         |
| 074-06-044     | 36402        | 074-09-3428    | 36405        | CG-60890-NM    | 5537NM       | SHC-1010-CR    | 5504         |
| 074-06-045     | 36403        | 074-09-3430    | 37033        | CG-608-NM      | 5536NM       | SHC-1011-CR    | 5506         |
| 074-06-046     | 36404        | 074-09-3432    | 37034        | CG-61090-NM    | 5539NM       | SHC-1012-CR    | 5508         |
| 074-06-047     | 36405        | 074-09-3436    | 37035        | CG-610-NM      | 5538NM       | SHC-1018-CR    | 5528         |
| 074-06-048     | 37033        | 074-09-3441    | 36442        | CG-610-SST     | 5538MSS      | SHC-1019-CR    | 5518         |
| 074-06-049     | 37034        | 074-09-3442    | 36390        | CG-61290-NM    | 5543NM       | SHC-1020-CR    | 5520         |
| 074-06-050     | 37035        | 074-09-3443    | 36391        | CG-612-NM      | 5542NM       | SHC-1020-SS    | 5520SS       |
| 074-06-061     | 36443        | 074-09-3444    | 36392        | CG-612-SST     | 5542MSS      | SHC-1021-CR    | 5522         |
| 074-06-062     | 36400        | 074-09-3445    | 36393        | CG-81090-NM    | 5549NM       | SHC-1021-SS    | 5522SS       |
| 074-06-063     | 36401        | 074-09-3446    | 36394        | CG-810-NM      | 5548NM       | SHC-1022-CR    | 5524/5526    |
| 074-06-064     | 36402        | 074-09-3448    | 36395        | CG-810-SST     | 5548MSS      | SHC-1022-SS    | 5524SS       |
| 074-06-065     | 36403        | 074-09-3511    | 36440        | CG-81290-NM    | 5553NM       | SHC-1022-SS    | 5526SS       |
| 074-06-066     | 36404        | 074-09-3512    | 36370        | CG-812-NM      | 5552NM       | SHC-1023-CR    | 5528/5530    |
| 074-06-067     | 36405        | 074-09-3513    | 36371        | CG-812-SST     | 5552MSS      | SHC-1023-SS    | 5528SS       |
| 074-06-068     | 37033        | 074-09-3514    | 36372        | CG-81490-NM    | 5557NM       | SHC-1023-SS    | 5530SS       |
| 074-06-069     | 37034        | 074-09-3515    | 36373        | CG-814-NM      | 5556NM       | SHC-1024-CR    | 5532/5534    |
| 074-06-070     | 37035        | 074-09-3516    | 36374        | CG-814-SST     | 5556MSS      | SHC-1024-SS    | 5532SS       |
| 074-06-088     | 36442        | 074-09-3518    | 36375        | CG-81690-NM    | 5561NM       | SHC-1024-SS    | 5534SS       |
| 074-06-089     | 36390        | 074-09-3520    | 37030        | CG-816-NM      | 5558NM       | SHC-1024-SS    | 5556SS       |
| 074-06-090     | 36391        | 074-09-3522    | 37031        | CG-816-SST     | 5560MSS      | SHC-1035-CR    | 5624/5536    |
| 074-06-091     | 36392        | 074-09-3526    | 37032        | H0389CNK       | 37100-90     | SHC-1035-SS    | 5624SS       |
| 074-06-092     | 36393        | 074-09-3541    | 36443        | H038CNK        | 37100        | SHC-1036-CR    | 5538         |
| 074-06-093     | 36394        | 074-09-3542    | 36400        | H0509CNK       | 37101-90     | SHC-1036-SS    | 5538SS       |
| 074-06-094     | 36395        | 074-09-3543    | 36401        | H050CNK        | 37101        | SHC-1037-CR    | 5542         |
| 074-08-1365    | 37100        | 074-09-3544    | 36402        | H0759CNK       | 37102-90     | SHC-1037-SS    | 5542SS       |
| 074-08-1366    | 37101        | 074-09-3545    | 36403        | H075CNK        | 37102        | SHC-1039-CR    | 5546         |
| 074-08-1367    | 37102        | 074-09-3546    | 36404        | H1009CNK       | 37103-90     | SHC-1040-CR    | 5548         |
| 074-08-1368    | 37103        | 074-09-3548    | 36405        | H100CNK        | 37103        | SHC-1041-CR    | 5552         |
| 074-08-1369    | 37104        | 074-09-3550    | 37033        | H1259CNK       | 37104-90     | SHC-1042-CR    | 5556         |
| 074-08-1370    | 37105        | 074-09-3552    | 37034        | H125CNK        | 37104        | SHC-1043-CR    | 5560         |
| 074-08-1371    | 37106        | 074-09-3556    | 37035        | H1509CNK       | 37105-90     | SHC-1043SS     | 5560SS       |
| 074-08-1372    | 37100-90     | 074-09-3561    | 36442        | H150CNK        | 37105        | SHC-1044-CR    | 5562         |
| 074-08-1373    | 37101-90     | 074-09-3562    | 36390        | H2009CNK       | 37106-90     | SHC-1044-SS    | 5562SS       |
| 074-08-1374    | 37102-90     | 074-09-3563    | 36391        | H200CNK        | 37106        | UFC-0001-CR    | 5580         |
| 074-08-1375    | 37103-90     | 074-09-3564    | 36392        | NHC-1019-CR    | 5519         | UFC-0003-CR    | 5586         |
| 074-08-1376    | 37104-90     | 074-09-3565    | 36393        | NHC-1020-CR    | 5521         |                |              |
| 074-08-1377    | 37105-90     | 074-09-3566    | 36394        | NHC-1021-CR    | 5523         |                |              |
| 074-08-1378    | 37106-90     | 074-09-3568    | 36395        | NHC-1022-CR    | 5525/5527    |                |              |
| 074-09-0310    | 37030        | 076-06-011     | 36440        | NHC-1023-CR    | 5529/5531    |                |              |
| 074-09-3401    | 36440        | 203-02-001     | 36237        | NHC-1024-CR    | 5533/5535    |                |              |



## UL/CSA APPROVALS BY PART NUMBER

| PART NO. | UL      | CSA     | PART NO. | UL      | CSA     | PART NO. | UL      | CSA     | PART NO. | UL      | CSA     |
|----------|---------|---------|----------|---------|---------|----------|---------|---------|----------|---------|---------|
| 105      | E59251  | LR1533  | 1534     | E10176  | LR6837  | 2781     | E10176  | —       | 4010     | —       | LR32400 |
| 106      | E59251  | LR1533  | 1547     | E10176  | LR6837  | 2782     | E10176  | —       | 4011     | —       | LR32400 |
| 300      | —       | LR1533  | 1548     | E10176  | —       | 2783     | E10176  | —       | 4012     | —       | LR32400 |
| 301      | —       | LL85374 | 1549     | E10176  | LR6837  | 2809     | E10176  | —       | 4022     | —       | LR32400 |
| 310      | —       | LL85374 | 1606     | —       | LL85374 | 2847     | E10176  | LR6837  | 4023     | —       | LR32400 |
| 402      | E59049  | LL85374 | 1610     | E59049  | —       | 2848     | E10176  | LR6837  | 4024     | —       | LR32400 |
| 405      | E59049  | LL85374 | 1612     | E59049  | LL85374 | 2849     | E10176  | LR6837  | 4026     | —       | LR32400 |
| 440      | —       | LR6837  | 1682     | E59049  | LL85374 | 2874     | E10176  | LR6837  | 4028     | —       | LR32400 |
| 442      | —       | LR6837  | 1684     | E59049  | LL85374 | 2875     | E10176  | LR6837  | 4052     | —       | LR32400 |
| 445      | —       | LR6837  | 1701     | —       | LR6837  | 2876     | E10176  | LR6837  | 4202     | —       | LR32400 |
| 446      | —       | LR6837  | 1704     | —       | LR6837  | 2877     | E10176  | LR6837  | 4203     | —       | LR32400 |
| 600      | E73750  | LR1533  | 1705     | E10176  | LR6837  | 2881     | E10176  | —       | 4204     | —       | LR32400 |
| 601      | —       | LR1533  | 1708     | —       | LR6837  | 2882     | E10176  | —       | 4205     | —       | LR32400 |
| 602      | —       | LR1533  | 1712     | E10176  | LR6837  | 2883     | E10176  | —       | 4206     | —       | LR32400 |
| 603      | —       | LR1533  | 1719     | —       | LR6837  | 2908     | E10176  | LR6837  | 4207     | —       | LR32400 |
| 606      | E73750  | LR1533  | 1725     | —       | LR6837  | 2909     | E10176  | LR6837  | 4208     | —       | LR32400 |
| 611      | —       | LL85374 | 1730     | —       | LR6837  | 2947     | E10176  | —       | 4209     | —       | LR32400 |
| 910      | —       | LR29921 | 1732     | —       | LR6837  | 2948     | E10176  | —       | 4212     | —       | LR32400 |
| 920      | —       | LR29921 | 1733     | —       | LR6837  | 2949     | E10176  | —       | 4720     | E10176  | LR6837  |
| 930      | E22769  | —       | 1740     | E10176  | LR6837  | 2974     | E10176  | —       | 4729     | E10176  | LR6837  |
| 931      | E22769  | —       | 1741     | E10176  | LR6837  | 2975     | E10176  | —       | 4747     | E46237  | LR6837  |
| 932      | E22769  | —       | 1744     | —       | LR6837  | 2976     | E10176  | —       | 4748     | E46237  | LR6837  |
| 963      | E22769  | LL85374 | 1783     | —       | LR6837  | 2977     | E10176  | —       | 4749     | —       | LR6837  |
| 966      | E22769  | —       | 2000     | E174254 | LL85374 | 2981     | E10176  | —       | 4770     | —       | LR6837  |
| 980      | E22769  | —       | 2001     | E174254 | LL85374 | 2982     | E10176  | —       | 4774     | E46237  | LR6837  |
| 990      | E22769  | —       | 2002     | E174254 | LL85374 | 2983     | E10176  | —       | 4775     | E46237  | LR6837  |
| 997      | E22769  | —       | 2003     | E174254 | LL85374 | 3000     | E46237  | LR6837  | 4776     | E46237  | LR6837  |
| 1045     | E59049  | LL85374 | 2010     | E174254 | LL85374 | 3001     | E46237  | LR6837  | 4779     | —       | LR6837  |
| 1049     | E59049  | LL85374 | 2011     | E174254 | LL85374 | 3003     | E46237  | LR6837  | 4947     | E46237  | LR6837  |
| 1152     | E59251  | —       | 2012     | E174254 | LL85374 | 3005     | E46237  | LR6837  | 4948     | E46237  | —       |
| 1153     | E59251  | —       | 2030     | E174254 | LL85374 | 3006     | E46237  | LR6837  | 4949     | E46237  | LR6837  |
| 1156     | E59251  | —       | 2031     | E174254 | LL85374 | 3008     | E46237  | —       | 4974     | E46237  | LR6837  |
| 1157     | E59251  | —       | 2032     | E174254 | LL85374 | 3080     | E46237  | LR6837  | 4975     | E46237  | LR6837  |
| 1160     | E59251  | —       | 2300     | E174254 | —       | 3081     | E46237  | LR6837  | 4976     | E46237  | LR6837  |
| 1161     | E59251  | —       | 2316     | E174254 | —       | 3082     | E46237  | LR6837  | 5000     | E112216 | —       |
| 1162     | E59251  | —       | 2320     | E174254 | —       | 3083     | E46237  | LR6837  | 5001     | E112216 | —       |
| 1164     | E59251  | —       | 2370     | E174254 | —       | 3085     | E46237  | LR6837  | 5002     | E112216 | —       |
| 1165     | E59251  | —       | 2404     | —       | LR6837  | 3086     | E46237  | LR6837  | 5003     | E112216 | —       |
| 1166     | E59251  | —       | 2434     | E10176  | LR6837  | 3200     | —       | LR6837  | 5006     | E112216 | LL85374 |
| 1168     | E59251  | LL85374 | 2447     | E10176  | LR6837  | 3210     | —       | LR6837  | 5007     | E112216 | LL85374 |
| 1173     | —       | LR1533  | 2449     | E10176  | LR6837  | 3215     | —       | LR6837  | 5008     | E112216 | LL85374 |
| 1174     | —       | LR1533  | 2504     | —       | LR6837  | 3220     | —       | LR6837  | 5009     | E112216 | LL85374 |
| 1203     | E59251  | LR1533  | 2534     | E10176  | LR6837  | 3225     | —       | LR6837  | 5166     | E10176  | LR6837  |
| 1207     | E59251  | LR1533  | 2547     | E10176  | LR6837  | 3230     | —       | LR6837  | 5169     | E10176  | LR6837  |
| 1220     | E59251  | LR1533  | 2549     | E10176  | LR6837  | 3235     | —       | LR6837  | 5176     | E10176  | LR6837  |
| 1223     | E59049  | LL85374 | 2607     | E10176  | LR6837  | 3240     | —       | LR6837  | 5266     | E10176  | LR6837  |
| 1225     | E59049  | LL85374 | 2608     | E10176  | LR6837  | 3245     | —       | LR6837  | 5269     | E10176  | LR6837  |
| 1229     | —       | LL85374 | 2609     | E10176  | LR6837  | 3250     | —       | LR6837  | 5366     | E10176  | LR6837  |
| 1262     | E59251  | LR1533  | 2610     | E10176  | —       | 3255     | —       | LR6837  | 5369     | E10176  | —       |
| 1324     | E174254 | LL85374 | 2647     | E10176  | LR6837  | 3400     | E135568 | —       | 5398     | —       | LR32159 |
| 1326     | E174254 | LL85374 | 2648     | E10176  | LR6837  | 3403     | E135568 | —       | 5400     | —       | LR32159 |
| 1334     | E174254 | LL85374 | 2649     | E10176  | LR6837  | 3410     | E135568 | —       | 5402     | —       | LR32159 |
| 1335     | E174254 | LL85374 | 2674     | E10176  | LR6837  | 3413     | E135568 | —       | 5466     | E10176  | —       |
| 1336     | E174254 | LL85374 | 2675     | E10176  | LR6837  | 3420     | E135568 | —       | 5469     | E10176  | —       |
| 1337     | E174254 | LL85374 | 2676     | E10176  | LR6837  | 3423     | E135568 | —       | 5500     | E76954  | LR32159 |
| 1350     | E174254 | LL85374 | 2681     | E10176  | —       | 3492     | —       | LR6837  | 5501     | E76954  | LR32159 |
| 1351     | E174254 | LL85374 | 2682     | E10176  | —       | 3493     | —       | LR6837  | 5502     | E76954  | LR32159 |
| 1352     | E174254 | LL85374 | 2683     | E10176  | —       | 3494     | —       | LR6837  | 5503     | E76954  | LR32159 |
| 1404     | E10176  | LR6837  | 2707     | E10176  | LR6837  | 3500     | E93230  | LR6837  | 5504     | E76954  | LR32159 |
| 1407     | E59049  | —       | 2708     | E10176  | —       | 3510     | E93230  | LR6837  | 5505     | E76954  | LR32159 |
| 1419     | E10176  | LR6837  | 2709     | E10176  | —       | 4002     | —       | LR32400 | 5506     | E76954  | LR32159 |
| 1433     | E10176  | LR6837  | 2710     | E10176  | —       | 4003     | —       | LR32400 | 5507     | E76954  | LR32159 |
| 1434     | E10176  | LR6837  | 2747     | E10176  | LR6837  | 4004     | —       | LR32400 | 5508     | E76954  | LR32159 |
| 1447     | E10176  | LR6837  | 2748     | E10176  | LR6837  | 4005     | —       | LR32400 | 5509     | E76954  | LR32159 |
| 1448     | E10176  | LR6837  | 2749     | E10176  | —       | 4006     | —       | LR32400 | 5518     | —       | LR32159 |
| 1449     | E10176  | LR6837  | 2774     | E10176  | LR6837  | 4007     | —       | LR32400 | 5519     | —       | LR32159 |
| 1504     | E10176  | LR6837  | 2775     | E10176  | LR6837  | 4008     | —       | LR32400 | 5520     | E76954  | LR32159 |
| 1533     | E10176  | —       | 2776     | E10176  | —       | 4009     | —       | LR32400 | 5521     | E76954  | LR32159 |





UL/CSA APPROVALS BY PART NUMBER

| PART NO. | UL     | CSA     | PART NO. | UL      | CSA     | PART NO. | UL | CSA     | PART NO. | UL | CSA     |
|----------|--------|---------|----------|---------|---------|----------|----|---------|----------|----|---------|
| 5522     | E76954 | LR32159 | 5669     | E10176  | —       | 35066    | —  | LR32159 | 35278    | —  | LR32159 |
| 5523     | E76954 | LR32159 | 5766     | —       | LR6837  | 35067    | —  | LR32159 | 35279    | —  | LR32159 |
| 5523     | E76954 | LR32159 | 5769     | —       | LR6837  | 35068    | —  | LR32159 | 35280    | —  | LR32159 |
| 5524     | E76954 | LR32159 | 8505     | —       | LL85374 | 35069    | —  | LR32159 | 35285    | —  | LR32159 |
| 5525     | E76954 | LR32159 | 8506     | —       | LL85374 | 35070    | —  | LR32159 | 35286    | —  | LR32159 |
| 5526     | E76954 | LR32159 | 8565     | E174254 | —       | 35090    | —  | LR32159 | 35287    | —  | LR32159 |
| 5527     | E76954 | LR32159 | 8664     | E10176  | LR6837  | 35091    | —  | LR32159 | 35288    | —  | LR32159 |
| 5528     | E76954 | LR32159 | 8665     | E10176  | LR6837  | 35092    | —  | LR32159 | 35289    | —  | LR32159 |
| 5529     | E76954 | LR32159 | 9206     | E22769  | LR29921 | 35093    | —  | LR32159 | 35290    | —  | LR32159 |
| 5530     | E76954 | LR32159 | 9208     | E22769  | LR29921 | 35094    | —  | LR32159 | 35291    | —  | LR32159 |
| 5531     | E76954 | LR32159 | 9224     | E22769  | LR29921 | 35095    | —  | LR32159 | 35292    | —  | LR32159 |
| 5532     | E76954 | LR32159 | 9228     | E22769  | —       | 35096    | —  | LR32159 | 35293    | —  | LR32159 |
| 5533     | E76954 | LR32159 | 9234     | E22769  | LR29921 | 35097    | —  | LR32159 | 35294    | —  | LR32159 |
| 5534     | E76954 | LR32159 | 9238     | E22769  | —       | 35098    | —  | LR32159 | 35295    | —  | LR32159 |
| 5535     | E76954 | LR32159 | 9242     | E22769  | LR29921 | 35099    | —  | LR32159 | 35300    | —  | LR32159 |
| 5536     | E76954 | LR32159 | 9253     | E22769  | LR29921 | 35100    | —  | LR32159 | 35301    | —  | LR32159 |
| 5537     | E76954 | LR32159 | 9306     | E22769  | LR29921 | 35135    | —  | LR32159 | 35302    | —  | LR32159 |
| 5538     | E76954 | LR32159 | 9308     | E22769  | LR29921 | 35136    | —  | LR32159 | 35303    | —  | LR32159 |
| 5539     | E76954 | LR32159 | 9358     | E22769  | LR29921 | 35137    | —  | LR32159 | 35304    | —  | LR32159 |
| 5540     | E76954 | LR32159 | 9363     | E22769  | LR29921 | 35138    | —  | LR32159 | 35305    | —  | LR32159 |
| 5541     | E76954 | LR32159 | 9367     | E22769  | —       | 35139    | —  | LR32159 | 35306    | —  | LR32159 |
| 5542     | E76954 | LR32159 | 9383     | E22769  | LR29921 | 35140    | —  | LR32159 | 35307    | —  | LR32159 |
| 5543     | E76954 | LR32159 | 9385     | E22769  | —       | 35141    | —  | LR32159 | 35308    | —  | LR32159 |
| 5544     | E76954 | LR32159 | 9394     | E22769  | LR29921 | 35142    | —  | LR32159 | 35309    | —  | LR32159 |
| 5545     | E76954 | LR32159 | 15054    | E66308  | —       | 35143    | —  | LR32159 | 35310    | —  | LR32159 |
| 5546     | E76954 | LR32159 | 20054    | E66308  | —       | 35144    | —  | LR32159 | 35330    | —  | LR32159 |
| 5547     | E76954 | LR32159 | 31550    | E10176  | LR6837  | 35145    | —  | LR32159 | 35331    | —  | LR32159 |
| 5548     | E76954 | LR32159 | 31552    | —       | LR6837  | 35165    | —  | LR32159 | 35332    | —  | LR32159 |
| 5549     | E76954 | LR32159 | 31565    | E10176  | LR6837  | 35166    | —  | LR32159 | 35333    | —  | LR32159 |
| 5550     | E76954 | LR32159 | 31593    | E10176  | LR6837  | 35167    | —  | LR32159 | 35334    | —  | LR32159 |
| 5551     | E76954 | LR32159 | 31594    | E10176  | LR6837  | 35168    | —  | LR32159 | 35335    | —  | LR32159 |
| 5552     | E76954 | LR32159 | 32547    | E10176  | LR6837  | 35169    | —  | LR32159 | 35336    | —  | LR32159 |
| 5553     | E76954 | LR32159 | 32550    | —       | LR6837  | 35170    | —  | LR32159 | 35337    | —  | LR32159 |
| 5554     | E76954 | LR32159 | 32553    | —       | LR6837  | 35171    | —  | LR32159 | 35338    | —  | LR32159 |
| 5555     | E76954 | LR32159 | 32706    | —       | LR6837  | 35172    | —  | LR32159 | 35339    | —  | LR32159 |
| 5556     | E76954 | LR32159 | 32708    | E10176  | LR6837  | 35173    | —  | LR32159 | 35340    | —  | LR32159 |
| 5557     | E76954 | LR32159 | 32747    | E10176  | LR6837  | 35174    | —  | LR32159 | 35425    | —  | LR32159 |
| 5558     | E76954 | LR32159 | 34047    | —       | LR6837  | 35175    | —  | LR32159 | 35426    | —  | LR32159 |
| 5559     | E76954 | LR32159 | 34048    | —       | LR6837  | 35195    | —  | LR32159 | 35427    | —  | LR32159 |
| 5560     | E76954 | LR32159 | 34547    | —       | LR6837  | 35196    | —  | LR32159 | 35428    | —  | LR32159 |
| 5561     | E76954 | LR32159 | 35001    | —       | LR32159 | 35197    | —  | LR32159 | 35429    | —  | LR32159 |
| 5562     | E76954 | LR32159 | 35002    | —       | LR32159 | 35198    | —  | LR32159 | 35430    | —  | LR32159 |
| 5563     | E76954 | LR32159 | 35003    | —       | LR32159 | 35199    | —  | LR32159 | 35431    | —  | LR32159 |
| 5568     | E76954 | LR32159 | 35004    | —       | LR32159 | 35200    | —  | LR32159 | 35432    | —  | LR32159 |
| 5569     | E76954 | LR32159 | 35005    | —       | LR32159 | 35201    | —  | LR32159 | 35433    | —  | LR32159 |
| 5570     | E76954 | LR32159 | 35006    | —       | LR32159 | 35202    | —  | LR32159 | 35435    | —  | LR32159 |
| 5571     | E76954 | LR32159 | 35007    | —       | LR32159 | 35203    | —  | LR32159 | 35436    | —  | LR32159 |
| 5572     | E76954 | LR32159 | 35008    | —       | LR32159 | 35204    | —  | LR32159 | 35437    | —  | LR32159 |
| 5573     | E76954 | LR32159 | 35009    | —       | LR32159 | 35205    | —  | LR32159 | 35438    | —  | LR32159 |
| 5574     | E76954 | LR32159 | 35010    | —       | LR32159 | 35225    | —  | LR32159 | 35440    | —  | LR32159 |
| 5575     | E76954 | LR32159 | 35011    | —       | LR32159 | 35226    | —  | LR32159 | 35441    | —  | LR32159 |
| 5576     | E76954 | LR32159 | 35030    | —       | LR32159 | 35227    | —  | LR32159 | 35442    | —  | LR32159 |
| 5577     | E76954 | LR32159 | 35031    | —       | LR32159 | 35228    | —  | LR32159 | 35443    | —  | LR32159 |
| 5580     | —      | LR32159 | 35032    | —       | LR32159 | 35229    | —  | LR32159 | 35444    | —  | LR32159 |
| 5581     | —      | LR32159 | 35033    | —       | LR32159 | 35230    | —  | LR32159 | 35445    | —  | LR32159 |
| 5582     | —      | LR32159 | 35034    | —       | LR32159 | 35231    | —  | LR32159 | 35446    | —  | LR32159 |
| 5583     | —      | LR32159 | 35035    | —       | LR32159 | 35232    | —  | LR32159 | 35447    | —  | LR32159 |
| 5584     | —      | LR32159 | 35036    | —       | LR32159 | 35233    | —  | LR32159 | 35448    | —  | LR32159 |
| 5585     | —      | LR32159 | 35037    | —       | LR32159 | 35234    | —  | LR32159 | 35450    | —  | LR32159 |
| 5586     | —      | LR32159 | 35038    | —       | LR32159 | 35235    | —  | LR32159 | 35451    | —  | LR32159 |
| 5587     | —      | LR32159 | 35039    | —       | LR32159 | 35270    | —  | LR32159 | 35452    | —  | LR32159 |
| 5620     | E76954 | LR32159 | 35040    | —       | LR32159 | 35271    | —  | LR32159 | 35453    | —  | LR32159 |
| 5621     | E76954 | LR32159 | 35060    | —       | LR32159 | 35272    | —  | LR32159 | 35850    | —  | LR32159 |
| 5622     | E76954 | LR32159 | 35061    | —       | LR32159 | 35273    | —  | LR32159 | 35851    | —  | LR32159 |
| 5623     | E76954 | LR32159 | 35062    | —       | LR32159 | 35274    | —  | LR32159 | 35865    | —  | LR32159 |
| 5624     | E76954 | LR32159 | 35063    | —       | LR32159 | 35275    | —  | LR32159 | 35866    | —  | LR32159 |
| 5625     | E76954 | LR32159 | 35064    | —       | LR32159 | 35276    | —  | LR32159 | 35867    | —  | LR32159 |
| 5666     | E10176 | LR6837  | 35065    | —       | LR32159 | 35277    | —  | LR32159 | 35868    | —  | LR32159 |



## UL/CSA APPROVALS BY PART NUMBER

| PART NO. | UL | CSA     | PART NO. | UL     | CSA     | PART NO. | UL     | CSA     | PART NO. | UL     | CSA     |
|----------|----|---------|----------|--------|---------|----------|--------|---------|----------|--------|---------|
| 35869    | —  | LR32159 | 35972    | —      | LR32159 | 36271    | E76954 | LR32159 | 36404    | E61303 | LR32159 |
| 35870    | —  | LR32159 | 35973    | —      | LR32159 | 36272    | E76954 | LR32159 | 36405    | E61303 | LR32159 |
| 35871    | —  | LR32159 | 35974    | —      | LR32159 | 36273    | E76954 | LR32159 | 36430    | E76954 | LR32159 |
| 35872    | —  | LR32159 | 35975    | —      | LR32159 | 36274    | E76954 | LR32159 | 36431    | E76954 | LR32159 |
| 35873    | —  | LR32159 | 35976    | —      | LR32159 | 36275    | E76954 | LR32159 | 36432    | E76954 | LR32159 |
| 35874    | —  | LR32159 | 35980    | —      | LR32159 | 36276    | E76954 | LR32159 | 36436    | E76954 | LR32159 |
| 35875    | —  | LR32159 | 35990    | —      | LR32159 | 36277    | E76954 | LR32159 | 36437    | E76954 | LR32159 |
| 35880    | —  | LR32159 | 36101    | —      | LR32159 | 36278    | E76954 | LR32159 | 36438    | E76954 | LR32159 |
| 35881    | —  | LR32159 | 36102    | —      | LR32159 | 36279    | E76954 | LR32159 | 36440    | E61303 | LR32159 |
| 35882    | —  | LR32159 | 36103    | —      | LR32159 | 36280    | E76954 | LR32159 | 36442    | E61303 | LR32159 |
| 35883    | —  | LR32159 | 36104    | —      | LR32159 | 36282    | E76954 | LR32159 | 36443    | E61303 | LR32159 |
| 35884    | —  | LR32159 | 36105    | —      | LR32159 | 36284    | E76954 | LR32159 | 36469    | E76954 | LR32159 |
| 35885    | —  | LR32159 | 36106    | —      | LR32159 | 36286    | E76954 | LR32159 | 36470    | E76954 | LR32159 |
| 35886    | —  | LR32159 | 36107    | —      | LR32159 | 36287    | E76954 | LR32159 | 36471    | E76954 | LR32159 |
| 35887    | —  | LR32159 | 36108    | —      | LR32159 | 36288    | E76954 | LR32159 | 36472    | E76954 | LR32159 |
| 35897    | —  | LR32159 | 36109    | —      | LR32159 | 36289    | E76954 | LR32159 | 36473    | E76954 | LR32159 |
| 35898    | —  | LR32159 | 36111    | —      | LR32159 | 36290    | E76954 | LR32159 | 36475    | E76954 | LR32159 |
| 35899    | —  | LR32159 | 36112    | —      | LR32159 | 36292    | E76954 | LR32159 | 36476    | E76954 | LR32159 |
| 35901    | —  | LR32159 | 36113    | —      | LR32159 | 36294    | E76954 | LR32159 | 36477    | E76954 | LR32159 |
| 35902    | —  | LR32159 | 36114    | —      | LR32159 | 36296    | E76954 | LR32159 | 36478    | E76954 | LR32159 |
| 35903    | —  | LR32159 | 36115    | —      | LR32159 | 36298    | E76954 | LR32159 | 36479    | E76954 | LR32159 |
| 35904    | —  | LR32159 | 36116    | —      | LR32159 | 36300    | E76954 | LR32159 | 36480    | E76954 | LR32159 |
| 35905    | —  | LR32159 | 36117    | —      | LR32159 | 36302    | E76954 | LR32159 | 36481    | E76954 | LR32159 |
| 35906    | —  | LR32159 | 36118    | —      | LR32159 | 36310    | E76954 | LR32159 | 36482    | E76954 | LR32159 |
| 35907    | —  | LR32159 | 36120    | —      | LR32159 | 36312    | E76954 | LR32159 | 36483    | E76954 | LR32159 |
| 35908    | —  | LR32159 | 36121    | —      | LR32159 | 36314    | E76954 | LR32159 | 36484    | E76954 | LR32159 |
| 35909    | —  | LR32159 | 36122    | —      | LR32159 | 36316    | E76954 | LR32159 | 36485    | E76954 | LR32159 |
| 35910    | —  | LR32159 | 36123    | —      | LR32159 | 36317    | E76954 | LR32159 | 36486    | E76954 | LR32159 |
| 35911    | —  | LR32159 | 36124    | —      | LR32159 | 36319    | E76954 | LR32159 | 36487    | E76954 | LR32159 |
| 35912    | —  | LR32159 | 36125    | —      | LR32159 | 36321    | E76954 | LR32159 | 36488    | E76954 | LR32159 |
| 35913    | —  | LR32159 | 36126    | —      | LR32159 | 36323    | E76954 | LR32159 | 36489    | E76954 | LR32159 |
| 35914    | —  | LR32159 | 36127    | —      | LR32159 | 36326    | E76954 | LR32159 | 36490    | E76954 | LR32159 |
| 35915    | —  | LR32159 | 36128    | —      | LR32159 | 36328    | E76954 | LR32159 | 36496    | E76954 | LR32159 |
| 35916    | —  | LR32159 | 36130    | —      | LR32159 | 36330    | E76954 | LR32159 | 36497    | E76954 | LR32159 |
| 35917    | —  | LR32159 | 36131    | —      | LR32159 | 36340    | E76954 | LR32159 | 36498    | E76954 | LR32159 |
| 35918    | —  | LR32159 | 36132    | —      | LR32159 | 36342    | E76954 | LR32159 | 36499    | E76954 | LR32159 |
| 35919    | —  | LR32159 | 36133    | —      | LR32159 | 36344    | E76954 | LR32159 | 36500    | E76954 | LR32159 |
| 35930    | —  | LR32159 | 36134    | —      | LR32159 | 36346    | E76954 | LR32159 | 36501    | E76954 | LR32159 |
| 35931    | —  | LR32159 | 36135    | —      | LR32159 | 36347    | E76954 | LR32159 | 36503    | E76954 | LR32159 |
| 35932    | —  | LR32159 | 36136    | —      | LR32159 | 36349    | E76954 | LR32159 | 36505    | E76954 | LR32159 |
| 35933    | —  | LR32159 | 36137    | —      | LR32159 | 36351    | E76954 | LR32159 | 36506    | —      | LR32159 |
| 35934    | —  | LR32159 | 36140    | —      | LR32159 | 36353    | E76954 | LR32159 | 36508    | E76954 | LR32159 |
| 35935    | —  | LR32159 | 36141    | —      | LR32159 | 36355    | E76954 | LR32159 | 36512    | E76954 | LR32159 |
| 35940    | —  | LR32159 | 36142    | —      | LR32159 | 36357    | E76954 | LR32159 | 36513    | —      | LR32159 |
| 35941    | —  | LR32159 | 36143    | —      | LR32159 | 36359    | E76954 | LR32159 | 36514    | —      | LR32159 |
| 35942    | —  | LR32159 | 36144    | —      | LR32159 | 36361    | E76954 | LR32159 | 36515    | E76954 | LR32159 |
| 35943    | —  | LR32159 | 36145    | —      | LR32159 | 36362    | E76954 | LR32159 | 36516    | E76954 | LR32159 |
| 35944    | —  | LR32159 | 36146    | —      | LR32159 | 36363    | E76954 | LR32159 | 36517    | E76954 | LR32159 |
| 35945    | —  | LR32159 | 36147    | —      | LR32159 | 36364    | E76954 | LR32159 | 36518    | E76954 | LR32159 |
| 35946    | —  | LR32159 | 36148    | —      | LR32159 | 36370    | E61303 | LR32159 | 36519    | E76954 | LR32159 |
| 35947    | —  | LR32159 | 36149    | —      | LR32159 | 36371    | E61303 | LR32159 | 36550    | —      | LR32159 |
| 35948    | —  | LR32159 | 36150    | —      | LR32159 | 36372    | E61303 | LR32159 | 36551    | —      | LR32159 |
| 35950    | —  | LR32159 | 36245    | —      | LR32159 | 36373    | E61303 | LR32159 | 36552    | —      | LR32159 |
| 35951    | —  | LR32159 | 36246    | —      | LR32159 | 36374    | E61303 | LR32159 | 36553    | —      | LR32159 |
| 35952    | —  | LR32159 | 36248    | —      | LR32159 | 36375    | E61303 | LR32159 | 36554    | —      | LR32159 |
| 35953    | —  | LR32159 | 36249    | —      | LR32159 | 36380    | E61303 | LR32159 | 36555    | —      | LR32159 |
| 35954    | —  | LR32159 | 36250    | E76954 | LR32159 | 36381    | E61303 | LR32159 | 36560    | —      | LR32159 |
| 35955    | —  | LR32159 | 36251    | E76954 | LR32159 | 36382    | E61303 | LR32159 | 36562    | —      | LR32159 |
| 35956    | —  | LR32159 | 36254    | E76954 | LR32159 | 36390    | E61303 | LR32159 | 36564    | —      | LR32159 |
| 35960    | —  | LR32159 | 36256    | E76954 | LR32159 | 36391    | E61303 | LR32159 | 36567    | —      | LR32159 |
| 35961    | —  | LR32159 | 36257    | E76954 | LR32159 | 36392    | E61303 | LR32159 | 36569    | —      | LR32159 |
| 35962    | —  | LR32159 | 36259    | E76954 | LR32159 | 36393    | E61303 | LR32159 | 36571    | —      | LR32159 |
| 35963    | —  | LR32159 | 36261    | E76954 | LR32159 | 36394    | E61303 | LR32159 | 36574    | —      | LR32159 |
| 35964    | —  | LR32159 | 36263    | E76954 | LR32159 | 36395    | E61303 | LR32159 | 36580    | —      | LR32159 |
| 35965    | —  | LR32159 | 36265    | E76954 | LR32159 | 36400    | E61303 | LR32159 | 36582    | —      | LR32159 |
| 35966    | —  | LR32159 | 36267    | E76954 | LR32159 | 36401    | E61303 | LR32159 | 36584    | —      | LR32159 |
| 35970    | —  | LR32159 | 36269    | E76954 | LR32159 | 36402    | E61303 | LR32159 | 36587    | —      | LR32159 |
| 35971    | —  | LR32159 | 36270    | E76954 | LR32159 | 36403    | E61303 | LR32159 | 36589    | —      | LR32159 |



UL/CSA APPROVALS BY PART NUMBER

| PART NO. | UL | CSA     | PART NO. | UL      | CSA     | PART NO.  | UL     | CSA     | PART NO.      | UL      | CSA     |
|----------|----|---------|----------|---------|---------|-----------|--------|---------|---------------|---------|---------|
| 36591    | —  | LR32159 | 36829    | E76954  | LR32159 | 92681     | —      | LR29921 | 1003-3HO      | —       | LL85374 |
| 36594    | —  | LR32159 | 36830    | E76954  | LR32159 | 92702     | —      | LR29921 | 1003-3-P      | —       | LL85374 |
| 36610    | —  | LR32159 | 36831    | —       | LR32159 | 92712     | —      | LR29921 | 1005-3        | E59049  | LL85374 |
| 36611    | —  | LR32159 | 36834    | —       | LR32159 | 92725     | —      | LR29921 | 1013-3        | E59049  | LL85374 |
| 36612    | —  | LR32159 | 36835    | —       | LR32159 | 92726     | —      | LR29921 | 1015-3        | E59049  | LL85374 |
| 36613    | —  | LR32159 | 37030    | E61303  | LR32159 | 92732     | —      | LR29921 | 102000A01F030 | —       | LR6837  |
| 36614    | —  | LR32159 | 37031    | E61303  | LR32159 | 92733     | —      | LR29921 | 102001A01F030 | E46237  | LR6837  |
| 36615    | —  | LR32159 | 37032    | E61303  | LR32159 | 92734     | —      | LR29921 | 102002A01F030 | E46237  | LR6837  |
| 36620    | —  | LR32159 | 37033    | E61303  | LR32159 | 92735     | —      | LR29921 | 102003A01F030 | E46237  | LR6837  |
| 36621    | —  | LR32159 | 37034    | E61303  | LR32159 | 92736     | —      | LR29921 | 1026-12       | E174254 | —       |
| 36622    | —  | LR32159 | 37035    | E61303  | LR32159 | 92742     | —      | LR29921 | 103000A01F030 | E46237  | LR6837  |
| 36623    | —  | LR32159 | 37036    | E61303  | LR32159 | 92743     | —      | LR29921 | 103000A45M005 | E46237  | LR6837  |
| 36624    | —  | LR32159 | 37037    | E61303  | LR32159 | 92744     | —      | LR29921 | 103000A46M005 | E46237  | LR6837  |
| 36625    | —  | LR32159 | 37038    | E61303  | LR32159 | 92745     | —      | LR29921 | 103001A01F030 | E46237  | LR6837  |
| 36626    | —  | LR32159 | 37100    | E61303  | LR32159 | 92746     | —      | LR29921 | 103001A45M005 | E46237  | LR6837  |
| 36627    | —  | LR32159 | 37101    | E61303  | LR32159 | 92761     | —      | LR29921 | 103001A46M005 | E46237  | LR6837  |
| 36628    | —  | LR32159 | 37102    | E61303  | LR32159 | 92762     | —      | LR29921 | 103002A01F030 | E46237  | LR6837  |
| 36629    | —  | LR32159 | 37103    | E61303  | LR32159 | 92763     | —      | LR29921 | 103003A01F030 | E46237  | LR6837  |
| 36630    | —  | LR32159 | 37104    | E61303  | LR32159 | 92764     | —      | LR29921 | 103006A45M005 | E46237  | LR6837  |
| 36640    | —  | LR32159 | 37105    | E61303  | LR32159 | 92781     | —      | LR29921 | 103006A46M005 | E46237  | LR6837  |
| 36641    | —  | LR32159 | 37106    | E61303  | LR32159 | 92782     | —      | LR29921 | 103007A45M005 | E46237  | LR6837  |
| 36642    | —  | LR32159 | 40718    | E46237  | —       | 92783     | —      | LR29921 | 103007A46M005 | E46237  | LR6837  |
| 36643    | —  | LR32159 | 40761    | E152210 | —       | 92784     | —      | LR29921 | 104000A01F030 | E46237  | LR6837  |
| 36644    | —  | LR32159 | 40780    | E46237  | —       | 310123    | —      | LL85374 | 104000A45M005 | E46237  | LR6837  |
| 36645    | —  | LR32159 | 40925    | E46237  | —       | 310143    | —      | LL85374 | 104000A46M005 | E46237  | LR6837  |
| 36646    | —  | LR32159 | 41048    | E152210 | —       | 310223    | —      | LL85374 | 104001A01F030 | E46237  | LR6837  |
| 36647    | —  | LR32159 | 41132    | E46237  | —       | 310243    | —      | LL85374 | 104001A45M005 | E46237  | LR6837  |
| 36648    | —  | LR32159 | 41212    | E152210 | —       | 310323    | —      | LL85374 | 104001A46M005 | E46237  | LR6837  |
| 36649    | —  | LR32159 | 41344    | E46237  | —       | 310423    | —      | LL85374 | 104002A01F030 | E46237  | LR6837  |
| 36650    | —  | LR32159 | 41481    | E152210 | —       | 320122    | —      | LL85374 | 104003A01F030 | E46237  | LR6837  |
| 36660    | —  | LR32159 | 41593    | E46237  | —       | 320522    | —      | LL85374 | 104006A45M005 | E46237  | LR6837  |
| 36661    | —  | LR32159 | 55501    | E70531  | LR44136 | 321637    | —      | LL85374 | 104006A46M005 | E46237  | LR6837  |
| 36662    | —  | LR32159 | 55503    | E70531  | LR44136 | 323123    | —      | LL85374 | 104007A45M005 | E46237  | LR6837  |
| 36663    | —  | LR32159 | 55504    | E70531  | —       | 323124    | —      | LL85374 | 104007A46M005 | E46237  | LR6837  |
| 36664    | —  | LR32159 | 61430    | E30252  | LR39801 | 323125    | —      | LL85374 | 105000A01F030 | E46237  | LR6837  |
| 36665    | —  | LR32159 | 85000    | E10176  | LR6837  | 323126    | —      | LL85374 | 105001A01F030 | E46237  | LR6837  |
| 36670    | —  | LR32159 | 85002    | E10176  | LR6837  | 323133    | —      | LL85374 | 105002A01F030 | E46237  | LR6837  |
| 36671    | —  | LR32159 | 85050    | E10176  | LR6837  | 323134    | —      | LL85374 | 105002A01F060 | E46237  | LR6837  |
| 36672    | —  | LR32159 | 85053    | E10176  | LR6837  | 323135    | —      | LL85374 | 105003A01F030 | E46237  | LR6837  |
| 36673    | —  | LR32159 | 85125    | E52190  | —       | 323523    | —      | LL85374 | 1050-12       | E174254 | —       |
| 36674    | —  | LR32159 | 85266    | E10176  | LR6837  | 323524    | —      | LL85374 | 1050-PL       | E174254 | —       |
| 36675    | —  | LR32159 | 85269    | E10176  | LR6837  | 323525    | —      | LL85374 | 1050-PL12     | E174254 | —       |
| 36676    | —  | LR32159 | 85366    | E10176  | LR6837  | 323526    | —      | LL85374 | 1051-PL       | E174254 | —       |
| 36680    | —  | LR32159 | 85369    | E10176  | —       | 323533    | —      | LL85374 | 1051-PL12     | E174254 | —       |
| 36681    | —  | LR32159 | 85433    | E10176  | LR6837  | 323534    | —      | LL85374 | 1052-PL       | E174254 | —       |
| 36682    | —  | LR32159 | 85447    | E10176  | LR6837  | 323535    | —      | LL85374 | 1052-PL12     | E174254 | —       |
| 36683    | —  | LR32159 | 85547    | E10176  | LR6837  | 105101303 | E46237 | LR6837  | 105A163       | —       | LL85374 |
| 36684    | —  | LR32159 | 92401    | E22769  | LR29921 | 105101304 | E46237 | LR6837  | 105B163       | —       | LL85374 |
| 36685    | —  | LR32159 | 92402    | E22769  | LR29921 | 105101306 | E46237 | LR6837  | 105S          | E59251  | LR1533  |
| 36686    | —  | LR32159 | 92411    | E22769  | LR29921 | 105101308 | E46237 | LR6837  | 105SA163      | —       | LL85374 |
| 36690    | —  | LR32159 | 92433    | E22769  | LR29921 | 105101310 | E46237 | LR6837  | 105SB163      | —       | LL85374 |
| 36691    | —  | LR32159 | 92434    | E22769  | LR29921 | 105101312 | E46237 | LR6837  | 105U          | E59251  | LR1533  |
| 36692    | —  | LR32159 | 92443    | E22769  | LR29921 | 105101402 | E46237 | LR6837  | 105UA163      | —       | LL85374 |
| 36693    | —  | LR32159 | 92444    | E22769  | LR29921 | 105101403 | E46237 | LR6837  | 105UB163      | —       | LL85374 |
| 36694    | —  | LR32159 | 92463    | E22769  | LR29921 | 105101404 | E46237 | LR6837  | 105US         | E59251  | LR1533  |
| 36695    | —  | LR32159 | 92464    | E22769  | LR29921 | 105102303 | E46237 | LR6837  | 105USA163     | —       | LL85374 |
| 36696    | —  | LR32159 | 92481    | E22769  | LR29921 | 105102304 | E46237 | LR6837  | 105USB163     | —       | LL85374 |
| 36800    | —  | LR32159 | 92482    | E22769  | LR29921 | 105102306 | E46237 | LR6837  | 106000A01F030 | E46237  | LR6837  |
| 36801    | —  | LR32159 | 92483    | E22769  | LR29921 | 105102308 | E46237 | LR6837  | 106001A01F030 | E46237  | LR6837  |
| 36802    | —  | LR32159 | 92625    | —       | LR29921 | 105102310 | E46237 | LR6837  | 106002A01F030 | E46237  | LR6837  |
| 36803    | —  | LR32159 | 92631    | —       | LR29921 | 105102312 | E46237 | LR6837  | 106003A01F030 | E46237  | LR6837  |
| 36804    | —  | LR32159 | 92632    | —       | LR29921 | 105102402 | E46237 | LR6837  | 1060-PL       | E174254 | —       |
| 36805    | —  | LR32159 | 92633    | —       | LR29921 | 105102403 | E46237 | LR6837  | 1061-PL       | E174254 | —       |
| 36816    | —  | LR32159 | 92641    | —       | LR29921 | 105103306 | E46237 | LR6837  | 1062-PL       | E174254 | —       |
| 36818    | —  | LR32159 | 92642    | —       | LR29921 | 105103402 | E46237 | LR6837  | 106A163       | —       | LL85374 |
| 36819    | —  | LR32159 | 92643    | —       | LR29921 | 105103403 | E46237 | LR6837  | 106B163       | —       | LL85374 |
| 36826    | —  | LR32159 | 92661    | —       | LR29921 | 105103404 | E46237 | LR6837  | 106S          | E59251  | LR1533  |
| 36827    | —  | LR32159 | 92663    | —       | LR29921 | 1003-3    | E59049 | LL85374 | 106SA163      | —       | LL85374 |



## UL/CSA APPROVALS BY PART NUMBER

| PART NO.        | UL      | CSA     | PART NO.   | UL     | CSA     | PART NO.   | UL     | CSA     | PART NO.      | UL     | CSA     |
|-----------------|---------|---------|------------|--------|---------|------------|--------|---------|---------------|--------|---------|
| 106SB163        | —       | LL85374 | 1203A163   | —      | LL85374 | 14W07_163  | E38085 | LR6837  | 1601-12A      | E59049 | LL85374 |
| 106U            | E59251  | LR1533  | 1203B163   | —      | LL85374 | 14W19      | E10176 | LR6837  | 1601-12B      | E59049 | LL85374 |
| 106UA163        | —       | LL85374 | 1203GC     | E59251 | LR1533  | 14W33      | E10176 | LR6837  | 1610S         | E59049 | LL85374 |
| 106UB163        | —       | LL85374 | 1203I      | —      | LL85374 | 14W33_123  | E38085 | LR6837  | 1612S         | E59049 | LL85374 |
| 106US           | E59251  | LR1533  | 1203IA163  | —      | LL85374 | 14W33_143  | E38085 | LR6837  | 1621-12A      | E59049 | LL85374 |
| 106USA163       | —       | LL85374 | 1203IB163  | —      | LL85374 | 14W33EZ    | E10176 | LR6837  | 1621-12B      | E59049 | LL85374 |
| 106USB163       | —       | LL85374 | 1203IGC    | E59251 | LR1533  | 14W33-W    | —      | LL52750 | 1621-12B-P    | E59049 | —       |
| 1083-3          | E59049  | LL85374 | 1203IO     | —      | LR1533  | 14W33-W-IN | —      | LL52750 | 1625-12A      | E59049 | LL85374 |
| 1083-3-E        | —       | LL85374 | 1203Q0A163 | —      | LL85374 | 14W33-Y    | —      | LL52750 | 1625-12B      | E59049 | LL85374 |
| 1083-3M         | E174254 | LL85374 | 1203Q0B163 | —      | LL85374 | 14W33-Y-IN | —      | LL52750 | 1631-12A      | E59049 | LL85374 |
| 1083-3MM        | E174254 | LL85374 | 1203Q0GC   | —      | LR1533  | 14W34      | E10176 | LR6837  | 1631-12B      | E59049 | LL85374 |
| 1083-3MM-24     | —       | LL85374 | 1203R      | —      | LR1533  | 14W34_143  | E38085 | LR6837  | 1635-12A      | E30252 | LR39801 |
| 1083-3M-P       | —       | LL85374 | 1203RA163  | —      | LL85374 | 14W34_163  | E38085 | LR6837  | 1635-12B      | E30252 | LR39801 |
| 1083-3-P        | —       | LL85374 | 1203RB163  | —      | LL85374 | 14W47      | E10176 | LR6837  | 1638-12       | —      | LL85374 |
| 1085-3          | E59049  | LL85374 | 1203RGC    | E59251 | LR1533  | 14W47_143  | E38085 | LR6837  | 1639-12       | —      | LL85374 |
| 1085-3-P        | —       | LL85374 | 1203RI     | —      | LR1533  | 14W47_163  | E38085 | LR6837  | 1643-12       | —      | LL85374 |
| 1086-3          | E59049  | LL85374 | 1203RIA163 | —      | LL85374 | 14W47EZ    | E10176 | LR6837  | 1644-12       | —      | LL85374 |
| 1086-3-E        | —       | LL85374 | 1203RIB163 | —      | LL85374 | 14W47-Y    | —      | LL52750 | 1645-12       | E30252 | LR39801 |
| 1087-3          | E59049  | LL85374 | 1203RIGC   | E59251 | LR1533  | 14W47-Y-IN | —      | LL52750 | 1646-12       | E59049 | LL85374 |
| 1087-3-E        | —       | LL85374 | 1207A163   | —      | LL85374 | 14W48      | E10176 | LR6837  | 1647-12       | E59049 | LL85374 |
| 1090-HZ         | E30252  | LR39801 | 1207B163   | —      | LL85374 | 14W48_123  | E38085 | LR6837  | 1648-12B      | —      | LL85374 |
| 1090-HZ12A163   | E30252  | LR39801 | 1207GC     | E59251 | LR1533  | 14W48_143  | E38085 | LR6837  | 1649-12       | E59049 | LL85374 |
| 1090-HZ12B163   | E30252  | LR39801 | 1207R      | —      | LR1533  | 14W48-W    | —      | LL52750 | 1682S         | E59049 | LL85374 |
| 1090-HZ12IA163  | E30252  | LR39801 | 1207RA163  | —      | LL85374 | 14W48-W-IN | —      | LL52750 | 1684S         | E59049 | LL85374 |
| 1090-HZ12IB163  | E30252  | LR39801 | 1207RB163  | —      | LL85374 | 14W48-Y    | —      | LL52750 | 1691-12       | —      | LL85374 |
| 1090-HZ12IB163P | —       | LR39801 | 1207RGC    | E59251 | LR1533  | 14W48-Y-IN | —      | LL52750 | 1691-12B      | E59049 | LL85374 |
| 1090-HZ12ID143  | E30252  | LR39801 | 1404_142   | E38085 | LR6837  | 14W49      | E10176 | LR6837  | 1691-12BS     | E59049 | LL85374 |
| 1090-HZ12ID143P | —       | LR39801 | 1404_162   | E38085 | LR6837  | 14W49_143  | E38085 | LR6837  | 1692-12B      | E59049 | LL85374 |
| 1090-HZA163     | E30252  | LR39801 | 1404MB     | E38085 | LR6837  | 14W49_163  | E38085 | LR6837  | 1692-12BS     | E59049 | LL85374 |
| 1090-HZB163     | E30252  | LR39801 | 1407_143   | E38085 | LR6837  | 1504MB     | E46237 | LR6837  | 1913SA        | —      | LL85374 |
| 1090-HZD163     | E30252  | LR39801 | 1407_163   | E38085 | LR6837  | 15050-1    | E66308 | —       | 1913SB        | —      | LL85374 |
| 1093-3          | E59049  | LL85374 | 1433_123   | E38085 | LR6837  | 15050-25   | E66308 | —       | 1926SA        | —      | LL85374 |
| 1093-3-E        | —       | LL85374 | 1433_143   | E38085 | LR6837  | 15050-25TT | E66308 | —       | 1926SB        | —      | LL85374 |
| 1093-3M         | E174254 | LL85374 | 1433EZ     | E10176 | LR6837  | 15050-3TT  | E66308 | —       | 1940SA        | —      | LL85374 |
| 1093-3MM        | E174254 | LL85374 | 1433MB     | —      | LR6837  | 15050-50TT | E66308 | —       | 1940SB        | —      | LL85374 |
| 1095-3          | E59049  | LL85374 | 1433-W     | —      | LL52750 | 15050-6    | E66308 | —       | 1A3000-34     | —      | LR6837  |
| 1097-3          | E59049  | LL85374 | 1433-W-IN  | —      | LL52750 | 15050-6TT  | E66308 | —       | 1A5000-34     | —      | LR6837  |
| 1097-3-E        | —       | LL85374 | 1433-Y     | —      | LL52750 | 15051-1    | E66308 | —       | 1R2004A20A120 | E46237 | LR6837  |
| 1097-3M         | E174254 | LL85374 | 1433-Y-IN  | —      | LL52750 | 15051-25   | E66308 | —       | 1R2006A20A120 | E46237 | LR6837  |
| 1097-3MM        | E174254 | LL85374 | 1434_143   | E38085 | LR6837  | 15051-6    | E66308 | —       | 1R3000A20A10G | E46237 | LR6837  |
| 1099-3          | E59049  | LL85374 | 1434_163   | E38085 | LR6837  | 15052-1    | E66308 | —       | 1R3000A20A120 | E46237 | LR6837  |
| 1099-3-E        | —       | LL85374 | 1434MB     | —      | LR6837  | 15052-25   | E66308 | —       | 1R3000A28A10G | E46237 | LR6837  |
| 11202A01F030    | E46237  | LR6837  | 1447_143   | E38085 | LR6837  | 15052-6    | E66308 | —       | 1R3004A20A120 | E46237 | LR6837  |
| 11202A01F030    | E46237  | LR6837  | 1447_163   | E38085 | LR6837  | 15053-2    | E66308 | —       | 1R3006A20A10G | E46237 | LR6837  |
| 11202A01F030    | E46237  | LR6837  | 1447EZ     | E10176 | LR6837  | 15053-25   | E66308 | —       | 1R3006A20A120 | E46237 | LR6837  |
| 112023A01F030   | E46237  | LR6837  | 1447MB     | —      | LR6837  | 15053-50   | E66308 | —       | 1R3006A28A10G | E46237 | LR6837  |
| 11302A01F030    | E46237  | LR6837  | 1447-W     | —      | LL52750 | 15053W-2   | E66308 | —       | 1R4000A20A10G | E46237 | LR6837  |
| 11302A01F030    | E46237  | LR6837  | 1447-W-IN  | —      | LL52750 | 15053W-25  | E66308 | —       | 1R4000A28A10G | E46237 | LR6837  |
| 113022A01F030   | E46237  | LR6837  | 1447-Y     | —      | LL52750 | 15054-1    | E66308 | —       | 1R4004A20A120 | E46237 | LR6837  |
| 113023A01F030   | E46237  | LR6837  | 1447-Y-IN  | —      | LL52750 | 1533GCM    | E10176 | LR6837  | 1R4006A20A10G | E46237 | LR6837  |
| 113030A46M005   | E46237  | LR6837  | 1448_123   | E38085 | LR6837  | 1533MB     | E46237 | —       | 1R4006A20A120 | E46237 | LR6837  |
| 113031A45M005   | E46237  | LR6837  | 1448_143   | E38085 | LR6837  | 1543MB     | E10176 | LR6837  | 1R4006A28A10G | E46237 | LR6837  |
| 11402A01F030    | E46237  | LR6837  | 1448MB     | —      | LR6837  | 1547GCM    | E10176 | LR6837  | 1R5000A20A120 | E46237 | LR6837  |
| 11402A01F030    | E46237  | LR6837  | 1448-W     | —      | LL52750 | 1547MB     | E46237 | LR6837  | 1R5004A20A120 | E46237 | LR6837  |
| 114022A01F030   | E46237  | LR6837  | 1448-W-IN  | —      | LL52750 | 1548MB     | E46237 | —       | 1R5006A20A120 | E46237 | LR6837  |
| 114023A01F030   | E46237  | LR6837  | 1448-Y     | —      | LL52750 | 1549MB     | E46237 | LR6837  | 1R6004A20A130 | E46237 | LR6837  |
| 114032A46M005   | E46237  | LR6837  | 1448-Y-IN  | —      | LL52750 | 15L47      | E10176 | —       | 1R6006A20A130 | E46237 | LR6837  |
| 114033A45M005   | E46237  | LR6837  | 1449_143   | E38085 | LR6837  | 15L47BLK   | E10176 | —       | 2000PLX25     | —      | LR39801 |
| 11502A01F030    | E46237  | LR6837  | 1449_163   | E38085 | LR6837  | 15W04      | E10176 | LR6837  | 2000PLX50     | —      | LR39801 |
| 11502A01F030    | E46237  | LR6837  | 1449MB     | —      | LR6837  | 15W33      | E10176 | —       | 2001-E        | —      | LL85374 |
| 115022A01F030   | E46237  | LR6837  | 14F47      | E52190 | —       | 15W33GCM   | E10176 | LR6837  | 20051-1       | E66308 | —       |
| 115023A01F030   | E46237  | LR6837  | 14R33      | —      | LR6837  | 15W34      | E10176 | LR6837  | 20051-25      | E66308 | —       |
| 11602A01F030    | E46237  | LR6837  | 14R47      | E10176 | LR6837  | 15W47      | E10176 | LR6837  | 20051-6       | E66308 | —       |
| 11602A01F030    | E46237  | LR6837  | 14W04      | E10176 | LR6837  | 15W47GCM   | E10176 | LR6837  | 20052-1       | E66308 | —       |
| 116022A01F030   | E46237  | LR6837  | 14W04_142  | E38085 | LR6837  | 15W48      | E10176 | —       | 20052-25      | E66308 | —       |
| 116023A01F030   | E46237  | LR6837  | 14W04_162  | E38085 | LR6837  | 15W49      | E10176 | LR6837  | 20052-6       | E66308 | —       |
| 1175U           | E59251  | LR1533  | 14W07      | E59049 | —       | 1600-12A   | E59049 | LL85374 | 20053-2       | E66308 | —       |
| 1175US          | E59251  | LR1533  | 14W07_143  | E38085 | LR6837  | 1600-12B   | E59049 | LL85374 | 20053W-2      | E66308 | —       |



UL/CSA APPROVALS BY PART NUMBER

| PART NO.   | UL      | CSA     | PART NO.  | UL     | CSA     | PART NO.   | UL     | CSA     | PART NO.  | UL     | CSA    |
|------------|---------|---------|-----------|--------|---------|------------|--------|---------|-----------|--------|--------|
| 20054-1    | E66308  | —       | 2607_122  | E38085 | LR6837  | 26W47-W-IN | —      | LL52750 | 27W49     | E10176 | —      |
| 20054-25   | E66308  | —       | 2607_142  | E38085 | LR6837  | 26W47-Y    | —      | LL52750 | 27W74     | E10176 | LR6837 |
| 20054-6    | E66308  | —       | 2607MB    | —      | LR6837  | 26W47-Y-IN | —      | LL52750 | 27W75     | E10176 | LR6837 |
| 20055-1    | E66308  | —       | 2608_123  | E38085 | LR6837  | 26W48      | E10176 | LR6837  | 27W76     | E10176 | —      |
| 20055-25   | E66308  | —       | 2608_143  | E38085 | LR6837  | 26W48_123  | E38085 | LR6837  | 27W81     | E10176 | —      |
| 20055-6    | E66308  | —       | 2608G     | —      | LR6837  | 26W48_143  | E38085 | LR6837  | 27W82     | E10176 | —      |
| 202SRL     | E112216 | —       | 2608MB    | E10176 | LR6837  | 26W49      | E10176 | LR6837  | 27W83     | E10176 | —      |
| 2030PLX25  | —       | LR39801 | 2609_124  | E38085 | LR6837  | 26W49_123  | E38085 | LR6837  | 2808_103  | E38085 | LR6837 |
| 2030PLX50  | —       | LR39801 | 2609_144  | E38085 | LR6837  | 26W49_143  | E38085 | LR6837  | 2808_123  | E38085 | LR6837 |
| 2031-P     | —       | LL85374 | 2609MB    | E10176 | LR6837  | 26W74      | E10176 | LR6837  | 2808MB    | E10176 | LR6837 |
| 2113GS     | E174254 | LL85374 | 2610MB    | E10176 | LR6837  | 26W74_124  | E38085 | LR6837  | 2809_104  | E38085 | LR6837 |
| 2113MS     | E174254 | LL85374 | 2647_123  | E38085 | LR6837  | 26W74_144  | E38085 | LR6837  | 2809_124  | E38085 | LR6837 |
| 2113S      | E174254 | LL85374 | 2647_143  | E38085 | LR6837  | 26W75      | E10176 | LR6837  | 2809MB    | E10176 | LR6837 |
| 2126FMS    | —       | LL85374 | 2647EZ    | E10176 | LR6837  | 26W75_124  | E38085 | LR6837  | 2847_103  | E38085 | LR6837 |
| 2126GS     | E174254 | LL85374 | 2647MB    | E10176 | LR6837  | 26W75_144  | E38085 | LR6837  | 2847_123  | E38085 | LR6837 |
| 2126MS     | E174254 | LL85374 | 2647-W    | —      | LL52750 | 26W76      | E10176 | LR6837  | 2847MB    | E10176 | LR6837 |
| 2126S      | E174254 | LL85374 | 2647-W-IN | —      | LL52750 | 26W76_124  | E38085 | LR6837  | 2848_103  | E38085 | LR6837 |
| 2304F-30TZ | E174254 | —       | 2647-Y    | —      | LL52750 | 26W76_144  | E38085 | LR6837  | 2848_123  | E38085 | LR6837 |
| 2306F-30TZ | E174254 | —       | 2647-Y-IN | —      | LL52750 | 26W81      | E10176 | —       | 2848MB    | E10176 | LR6837 |
| 2316F-30TZ | E174254 | —       | 2648_123  | E38085 | LR6837  | 26W81_125  | E38085 | LR6837  | 2849_103  | E38085 | LR6837 |
| 2320F-20TZ | E174254 | —       | 2648_143  | E38085 | LR6837  | 26W82      | E10176 | —       | 2849_123  | E38085 | LR6837 |
| 2326F-30TZ | E174254 | —       | 2648MB    | E10176 | LR6837  | 26W82_125  | E38085 | LR6837  | 2849MB    | E10176 | LR6837 |
| 2404_142   | #NA     | LR6837  | 2649_123  | E38085 | LR6837  | 26W83      | E10176 | —       | 2874_104  | E38085 | LR6837 |
| 2404_162   | #NA     | LR6837  | 2649_143  | E38085 | LR6837  | 26W83_125  | E38085 | LR6837  | 2874_124  | E38085 | LR6837 |
| 2404MB     | —       | LR6837  | 2649MB    | E10176 | LR6837  | 270-1      | —      | LR1533  | 2874MB    | E10176 | LR6837 |
| 2434_143   | E38085  | LR6837  | 2674_124  | E38085 | LR6837  | 270-2      | —      | LR1533  | 2875_104  | E38085 | LR6837 |
| 2434_163   | E38085  | LR6837  | 2674_144  | E38085 | LR6837  | 270-3      | —      | LR1533  | 2875_124  | E38085 | LR6837 |
| 2434MB     | E10176  | LR6837  | 2674MB    | E10176 | LR6837  | 2707MB     | —      | LR6837  | 2875MB    | E10176 | LR6837 |
| 2447_143   | E38085  | LR6837  | 2675_124  | E38085 | LR6837  | 2708G      | —      | LR6837  | 2876_104  | E38085 | LR6837 |
| 2447_163   | E38085  | LR6837  | 2675_144  | E38085 | LR6837  | 2708MB     | E46237 | LR6837  | 2876_124  | E38085 | LR6837 |
| 2447EZ     | E10176  | LR6837  | 2675MB    | E10176 | LR6837  | 2709MB     | E46237 | LR6837  | 2876MB    | E10176 | LR6837 |
| 2447MB     | —       | LR6837  | 2676_124  | E38085 | LR6837  | 2710MB     | E46237 | LR6837  | 2877_104  | E38085 | LR6837 |
| 2447-W     | —       | LL52750 | 2676_144  | E38085 | LR6837  | 271S       | E59251 | LR1533  | 2877_124  | E38085 | LR6837 |
| 2447-W-IN  | —       | LL52750 | 2676MB    | E10176 | LR6837  | 271SA163   | —      | LL85374 | 2877MB    | E10176 | LR6837 |
| 2447-Y     | —       | LL52750 | 2681_125  | E38085 | LR6837  | 271SB163   | —      | LL85374 | 2881_105  | —      | LR6837 |
| 2447-Y-IN  | —       | LL52750 | 2681MB    | E10176 | LR6837  | 271U       | E59251 | LR1533  | 2881_125  | —      | LR6837 |
| 2449_143   | E38085  | LR6837  | 2682_125  | E38085 | LR6837  | 271UA163   | —      | LL85374 | 2881MB    | E10176 | LR6837 |
| 2449_163   | E38085  | LR6837  | 2683_125  | E38085 | LR6837  | 271UB163   | —      | LL85374 | 2882_105  | E38085 | LR6837 |
| 2449MB     | E10176  | LR6837  | 2683MB    | E10176 | LR6837  | 271US      | E59251 | LR1533  | 2882_125  | E38085 | LR6837 |
| 24T04      | E10176  | LR6837  | 26T07     | E10176 | LR6837  | 271USA163  | —      | LL85374 | 2882MB    | E10176 | LR6837 |
| 24T49      | E10176  | LR6837  | 26T08     | E10176 | LR6837  | 271USB163  | —      | LL85374 | 2883_105  | E38085 | LR6837 |
| 24W04      | —       | LR6837  | 26T08G    | —      | LR6837  | 2747GCM    | E10176 | —       | 2883_125  | E38085 | LR6837 |
| 24W04_142  | —       | LR6837  | 26T09     | E10176 | LR6837  | 2747MB     | E46237 | LR6837  | 28T08     | E10176 | LR6837 |
| 24W04_162  | —       | LR6837  | 26T10     | E10176 | —       | 2774MB     | E46237 | LR6837  | 28T09     | E10176 | LR6837 |
| 24W34      | E10176  | LR6837  | 26T47     | E10176 | LR6837  | 2775MB     | E46237 | LR6837  | 28T47     | E10176 | LR6837 |
| 24W34_143  | E38085  | LR6837  | 26T48     | E10176 | LR6837  | 2776MB     | E46237 | LR6837  | 28T48     | E10176 | LR6837 |
| 24W34_163  | E38085  | LR6837  | 26T49     | E10176 | LR6837  | 2781MB     | —      | LR6837  | 28T49     | E10176 | LR6837 |
| 24W47      | E10176  | LR6837  | 26T74     | E10176 | LR6837  | 2783MB     | E46237 | LR6837  | 28T74     | E10176 | LR6837 |
| 24W47_143  | E38085  | LR6837  | 26T75     | E10176 | LR6837  | 27T07      | E10176 | LR6837  | 28T75     | E10176 | LR6837 |
| 24W47_163  | E38085  | LR6837  | 26T76     | E10176 | LR6837  | 27T08      | E10176 | LR6837  | 28T76     | E10176 | LR6837 |
| 24W47EZ    | E10176  | LR6837  | 26T81     | E10176 | LR6837  | 27T08G     | E10176 | LR6837  | 28T77     | E10176 | LR6837 |
| 24W47-Y    | —       | LL52750 | 26T83     | E10176 | LR6837  | 27T09      | E10176 | LR6837  | 28T81     | E10176 | LR6837 |
| 24W47-Y-IN | —       | LL52750 | 26W07     | E10176 | LR6837  | 27T10      | E10176 | —       | 28T82     | E10176 | LR6837 |
| 24W49      | E10176  | LR6837  | 26W07_122 | E38085 | LR6837  | 27T47      | E10176 | LR6837  | 28T83     | E10176 | LR6837 |
| 24W49_143  | E38085  | LR6837  | 26W07_142 | E38085 | LR6837  | 27T48      | E10176 | LR6837  | 28W08     | E10176 | —      |
| 24W49_163  | E38085  | LR6837  | 26W08     | E10176 | LR6837  | 27T49      | E10176 | LR6837  | 28W08_103 | E38085 | LR6837 |
| 2504MB     | —       | LR6837  | 26W08_123 | E38085 | LR6837  | 27T74      | E10176 | LR6837  | 28W08_123 | E38085 | LR6837 |
| 2534MB     | E46237  | LR6837  | 26W08_143 | E38085 | LR6837  | 27T75      | E10176 | LR6837  | 28W09     | E10176 | —      |
| 2547GCM    | E10176  | LR6837  | 26W08G    | —      | LR6837  | 27T76      | E10176 | LR6837  | 28W09_104 | E38085 | LR6837 |
| 2547MB     | E46237  | LR6837  | 26W09     | E10176 | LR6837  | 27T81      | E10176 | LR6837  | 28W09_124 | E38085 | LR6837 |
| 2549MB     | E10176  | LR6837  | 26W09_124 | E38085 | LR6837  | 27T83      | E10176 | LR6837  | 28W47     | E10176 | LR6837 |
| 25T04      | E10176  | LR6837  | 26W09_144 | E38085 | LR6837  | 27W07      | —      | LR6837  | 28W47_103 | E38085 | LR6837 |
| 25T49      | E10176  | LR6837  | 26W10     | E10176 | —       | 27W08      | E10176 | LR6837  | 28W47_123 | E38085 | LR6837 |
| 25W04      | —       | LR6837  | 26W47     | E10176 | LR6837  | 27W08G     | —      | LR6837  | 28W48     | E10176 | LR6837 |
| 25W34      | E10176  | LR6837  | 26W47_123 | E38085 | LR6837  | 27W09      | E10176 | LR6837  | 28W48_103 | E38085 | LR6837 |
| 25W47      | E10176  | LR6837  | 26W47_143 | E38085 | LR6837  | 27W10      | E10176 | —       | 28W48_123 | E38085 | LR6837 |
| 25W47GCM   | E10176  | LR6837  | 26W47EZ   | E10176 | —       | 27W47      | E10176 | LR6837  | 28W49     | E10176 | LR6837 |
| 25W49      | E10176  | LR6837  | 26W47-W   | —      | LL52750 | 27W48      | E10176 | LR6837  | 28W49_103 | E38085 | LR6837 |





## UL/CSA APPROVALS BY PART NUMBER

| PART NO.    | UL     | CSA    | PART NO.    | UL      | CSA     | PART NO.   | UL     | CSA      | PART NO.    | UL     | CSA      |
|-------------|--------|--------|-------------|---------|---------|------------|--------|----------|-------------|--------|----------|
| 28W49_123   | E38085 | LR6837 | 3000F-1     | E46237  | LR6837  | 3088-9_123 | —      | LR6837   | 320P6       | —      | LR701227 |
| 28W74       | E10176 | LR6837 | 3001-2      | E46237  | LR6837  | 3088F      | E46237 | LR6837   | 320P6W      | —      | LR701227 |
| 28W74_104   | E38085 | LR6837 | 3001-2_143  | E38085  | LR6837  | 3100B4W    | —      | LR701227 | 320P7       | —      | LR701227 |
| 28W74_124   | E38085 | LR6837 | 3001F       | E46237  | LR6837  | 3100B5W    | —      | LR701227 | 320P7W      | —      | LR701227 |
| 28W75       | E10176 | LR6837 | 3003F       | E46237  | LR6837  | 3100B6W    | —      | LR701227 | 320R4       | —      | LR701227 |
| 28W75_104   | E38085 | LR6837 | 3005-1      | E46237  | LR6837  | 3100B7W    | —      | LR701227 | 320R4W      | —      | LR701227 |
| 28W75_124   | E38085 | LR6837 | 3005-1_143  | —       | LR6837  | 3100C4W    | —      | LR701227 | 320R5       | —      | LR701227 |
| 28W76       | E10176 | LR6837 | 3005-1      | E66308  | —       | 3100C5W    | —      | LR701227 | 320R5W      | —      | LR701227 |
| 28W76_104   | E38085 | LR6837 | 3005-1-6    | E66308  | —       | 3100C6W    | —      | LR701227 | 320R6       | —      | LR701227 |
| 28W76_124   | E38085 | LR6837 | 3005-2      | E46237  | LR6837  | 3100C7W    | —      | LR701227 | 320R6W      | —      | LR701227 |
| 28W77       | E10176 | LR6837 | 3005-2_143  | —       | LR6837  | 3100MI4W   | —      | LR701227 | 320R7       | —      | LR701227 |
| 28W77_104   | E38085 | LR6837 | 3005-2-1    | E66308  | —       | 3100MI6W   | —      | LR701227 | 320R7W      | —      | LR701227 |
| 28W77_124   | E38085 | LR6837 | 3005-2-6    | E66308  | —       | 3100MI7W   | —      | LR701227 | 32547A123   | E38085 | LR6837   |
| 28W81       | E10176 | —      | 3005-3-1    | E66308  | —       | 3100P4W    | —      | LR701227 | 32547A143   | E38085 | LR6837   |
| 28W81_105   | E38085 | —      | 3005-3-25   | E66308  | —       | 3100P5W    | —      | LR701227 | 32547B123   | E38085 | LR6837   |
| 28W81_125   | E38085 | —      | 3005-3-6    | E66308  | —       | 3100P6W    | —      | LR701227 | 32547B143   | E38085 | LR6837   |
| 28W82       | E10176 | —      | 3005-4-1    | E66308  | —       | 3100P7W    | —      | LR701227 | 32550A122   | —      | LR6837   |
| 28W82_105   | E38085 | —      | 3005-4-25   | E66308  | —       | 3100R4W    | —      | LR701227 | 32550A142   | —      | LR6837   |
| 28W82_125   | E38085 | —      | 3005-4-6    | E66308  | —       | 3100R5W    | —      | LR701227 | 32550B122   | —      | LR6837   |
| 28W83       | E10176 | —      | 3005-6      | E46237  | LR6837  | 3100R6W    | —      | LR701227 | 32550B142   | —      | LR6837   |
| 28W83_105   | E38085 | —      | 3005-6_142  | E38085  | LR6837  | 3100R7W    | —      | LR701227 | 32553A123   | —      | LR6837   |
| 28W83_125   | E38085 | —      | 3005-8      | —       | LR6837  | 310W       | —      | LR1533   | 32553A143   | —      | LR6837   |
| 2908MB      | E46237 | LR6837 | 3005-8_143  | E38085  | LR6837  | 31550A122  | E38085 | LR6837   | 32553B123   | —      | LR6837   |
| 2909MB      | E46237 | LR6837 | 3005F       | E46237  | LR6837  | 31550A142  | E38085 | LR6837   | 32553B143   | —      | LR6837   |
| 2947MB      | E46237 | LR6837 | 3006-2      | E46237  | LR6837  | 31550B122  | E38085 | LR6837   | 32706A122   | —      | LR6837   |
| 2948MB      | E46237 | LR6837 | 3006-2_143  | E38085  | LR6837  | 31550B142  | E38085 | LR6837   | 32706A142   | —      | LR6837   |
| 2949MB      | E46237 | LR6837 | 3006F       | E46237  | LR6837  | 31552A143  | E38085 | LR6837   | 32706B122   | —      | LR6837   |
| 2974MB      | E46237 | LR6837 | 3008F       | E46237  | LR6837  | 31552B123  | E38085 | LR6837   | 32706B142   | —      | LR6837   |
| 2975MB      | E46237 | LR6837 | 300W        | —       | LR1533  | 31552B143  | E38085 | LR6837   | 32708A123   | E38085 | LR6837   |
| 2976MB      | E46237 | LR6837 | 302SRL      | E112216 | LL85374 | 31565A123  | E38085 | LR6837   | 32708A143   | E38085 | LR6837   |
| 2977MB      | E46237 | LR6837 | 302SRLCA    | E112216 | —       | 31565A143  | E38085 | LR6837   | 32708B123   | E38085 | LR6837   |
| 2981MB      | E46237 | LR6837 | 302U        | —       | LR1533  | 31565B123  | E38085 | LR6837   | 32708B143   | E38085 | LR6837   |
| 2982MB      | E46237 | LR6837 | 3070F-GFI   | —       | LR6837  | 31565B143  | E38085 | LR6837   | 32747A123   | E38085 | LR6837   |
| 29T08       | E46237 | LR6837 | 3070-GFI    | —       | LR6837  | 31593A123  | E38085 | LR6837   | 32747A143   | E38085 | LR6837   |
| 29T09       | E10176 | LR6837 | 3080-1      | E46237  | LR6837  | 31593A143  | E38085 | LR6837   | 32747B123   | E38085 | LR6837   |
| 29T47       | E10176 | LR6837 | 3080-10     | E46237  | LR6837  | 31593B123  | E38085 | LR6837   | 32747B143   | E38085 | LR6837   |
| 29T48       | E10176 | LR6837 | 3080-10_123 | E38085  | LR6837  | 31593B143  | E38085 | LR6837   | 3290-1      | —      | LR6837   |
| 29T49       | E10176 | LR6837 | 3080-2      | E46237  | LR6837  | 31594A123  | E38085 | LR6837   | 3290-1B143  | —      | LR6837   |
| 29T74       | E10176 | LR6837 | 3080-6      | E46237  | LR6837  | 31594A143  | E38085 | LR6837   | 3290-1E143  | —      | LR6837   |
| 29T75       | E10176 | LR6837 | 3080-8      | —       | LR6837  | 31594B123  | E38085 | LR6837   | 3290-2      | —      | LR6837   |
| 29T76       | E10176 | LR6837 | 3080F       | E46237  | LR6837  | 31594B143  | E38085 | LR6837   | 3290-2B143  | —      | LR6837   |
| 29T77       | E10176 | LR6837 | 3080F-GFI   | —       | LR6837  | 320BA4     | —      | LR701227 | 3290-2E143  | —      | LR6837   |
| 29T81       | E10176 | LR6837 | 3080F-GFI20 | —       | LR6837  | 320BA4W    | —      | LR701227 | 3290-3      | —      | LR6837   |
| 29T82       | E10176 | LR6837 | 3080-GFI    | —       | LR6837  | 320BA5     | —      | LR701227 | 3290-3B123  | —      | LR6837   |
| 29T83       | E10176 | LR6837 | 3080-GFI20  | —       | LR6837  | 320BA5W    | —      | LR701227 | 3290-3E123  | —      | LR6837   |
| 29W08       | E10176 | LR6837 | 3081-2      | E46237  | LR6837  | 320BA6     | —      | LR701227 | 3290-8      | —      | LR6837   |
| 29W09       | E10176 | LR6837 | 3081-7      | E46237  | LR6837  | 320BA6W    | —      | LR701227 | 3290-8B143  | —      | LR6837   |
| 29W47       | E10176 | —      | 3081-7_122  | E38085  | LR6837  | 320BA7     | —      | LR701227 | 3290-8E143  | —      | LR6837   |
| 29W48       | E10176 | —      | 3081F       | E46237  | LR6837  | 320BA7W    | —      | LR701227 | 3290-9B123  | —      | LR6837   |
| 29W49       | E10176 | —      | 3083-3      | E46237  | LR6837  | 320C4      | —      | LR701227 | 3290-9E123  | —      | LR6837   |
| 29W74       | E10176 | —      | 3083-3_123  | E38085  | LR6837  | 320C4W     | —      | LR701227 | 32G15_123   | E66308 | LR6837   |
| 29W75       | E10176 | —      | 3083-9      | —       | LR6837  | 320C5      | —      | LR701227 | 32G20_123   | E66308 | LR6837   |
| 29W76       | E10176 | —      | 3083-9_123  | E38085  | LR6837  | 320C5W     | —      | LR701227 | 32GM15_123  | —      | LR6837   |
| 29W77       | E10176 | —      | 3083F       | E46237  | LR6837  | 320C6      | —      | LR701227 | 32GM20_123  | —      | LR6837   |
| 29W81       | E10176 | —      | 3085-1      | E46237  | LR6837  | 320C6W     | —      | LR701227 | 32HG15_123  | E66308 | LR6837   |
| 29W82       | E10176 | —      | 3085-10     | E46237  | LR6837  | 320C7      | —      | LR701227 | 32HG20_123  | E66308 | LR6837   |
| 29W83       | E10176 | —      | 3085-10_123 | E38085  | LR6837  | 320C7W     | —      | LR701227 | 32W07       | —      | LR6837   |
| 3000-1      | E46237 | LR6837 | 3085-2      | E46237  | LR6837  | 320M4      | —      | LR701227 | 32W33       | —      | LR6837   |
| 3000-1_143  | —      | LR6837 | 3085-6      | E46237  | LR6837  | 320M4W     | —      | LR701227 | 32W47       | —      | LR6837   |
| 3000-10     | E46237 | LR6837 | 3085-8      | —       | LR6837  | 320M5      | —      | LR701227 | 32W47A123   | —      | LR6837   |
| 3000-10_123 | E38085 | —      | 3085F       | E46237  | LR6837  | 320M6      | —      | LR701227 | 32W90-1     | —      | LR6837   |
| 3000-2      | E46237 | LR6837 | 3086-2      | E46237  | LR6837  | 320M6W     | —      | LR701227 | 32W90-1B143 | —      | LR6837   |
| 3000-2_143  | E38085 | LR6837 | 3086-7      | E46237  | LR6837  | 320M7      | —      | LR701227 | 32W90-1E143 | —      | LR6837   |
| 3000-6      | E46237 | LR6837 | 3086-7_122  | E38085  | LR6837  | 320M7W     | —      | LR701227 | 32W90-2     | —      | LR6837   |
| 3000-6_142  | E38085 | LR6837 | 3086F       | E46237  | LR6837  | 320P4      | —      | LR701227 | 32W90-2B143 | —      | LR6837   |
| 3000-8      | —      | LR6837 | 3088-3      | E46237  | LR6837  | 320P4W     | —      | LR701227 | 32W90-2E143 | —      | LR6837   |
| 3000-8_143  | —      | LR6837 | 3088-3_123  | E38085  | LR6837  | 320P5      | —      | LR701227 | 32W90-8     | —      | LR6837   |
| 3000F       | E46237 | LR6837 | 3088-9      | —       | LR6837  | 320P5W     | —      | LR701227 | 32W90-8B143 | —      | LR6837   |



UL/CSA APPROVALS BY PART NUMBER

| PART NO.    | UL | CSA      | PART NO.  | UL | CSA      | PART NO.      | UL | CSA      | PART NO.      | UL | CSA      |
|-------------|----|----------|-----------|----|----------|---------------|----|----------|---------------|----|----------|
| 32W90-8E143 | —  | LR6837   | 3410-20   | —  | E135568  | 360C7         | —  | LR701227 | 4100R12W      | —  | LR701227 |
| 32WG15_123  | —  | LR6837   | 3410F     | —  | E135568  | 360C7W        | —  | LR701227 | 4100R5W       | —  | LR701227 |
| 32WG20_123  | —  | LR6837   | 3410F-20  | —  | E135568  | 360P4         | —  | LR701227 | 4100R7W       | —  | LR701227 |
| 330BA12     | —  | LR701227 | 3410FL    | —  | E135568  | 360P4W        | —  | LR701227 | 4100R9W       | —  | LR701227 |
| 330BA12W    | —  | LR701227 | 3410FL-20 | —  | E135568  | 360P5         | —  | LR701227 | 420BA12       | —  | LR701227 |
| 330BA4      | —  | LR701227 | 3410L     | —  | E135568  | 360P5W        | —  | LR701227 | 420BA12W      | —  | LR701227 |
| 330BA4W     | —  | LR701227 | 3410L-20  | —  | E135568  | 360P6         | —  | LR701227 | 420BA5        | —  | LR701227 |
| 330BA5      | —  | LR701227 | 3410P     | —  | E135568  | 360P6W        | —  | LR701227 | 420BA5W       | —  | LR701227 |
| 330BA5W     | —  | LR701227 | 3410P-20  | —  | E135568  | 360P7         | —  | LR701227 | 420BA7        | —  | LR701227 |
| 330BA6      | —  | LR701227 | 3410PL    | —  | E135568  | 360P7W        | —  | LR701227 | 420BA7W       | —  | LR701227 |
| 330BA6W     | —  | LR701227 | 3410PL-20 | —  | E135568  | 360R4         | —  | LR701227 | 420BA9        | —  | LR701227 |
| 330BA7      | —  | LR701227 | 3413-20   | —  | E135568  | 360R4W        | —  | LR701227 | 420BA9W       | —  | LR701227 |
| 330BA7W     | —  | LR701227 | 3413F     | —  | E135568  | 360R5         | —  | LR701227 | 420C12        | —  | LR701227 |
| 330C4       | —  | LR701227 | 3413FL    | —  | E135568  | 360R5W        | —  | LR701227 | 420C12W       | —  | LR701227 |
| 330C4W      | —  | LR701227 | 3413FL-20 | —  | E135568  | 360R6         | —  | LR701227 | 420C5         | —  | LR701227 |
| 330C5       | —  | LR701227 | 3413L     | —  | E135568  | 360R6W        | —  | LR701227 | 420C5W        | —  | LR701227 |
| 330C5W      | —  | LR701227 | 3413L-20  | —  | E135568  | 360R7         | —  | LR701227 | 420C7         | —  | LR701227 |
| 330C6       | —  | LR701227 | 3413P     | —  | E135568  | 360R7W        | —  | LR701227 | 420C7W        | —  | LR701227 |
| 330C6W      | —  | LR701227 | 3413P-20  | —  | E135568  | 37100-90      | —  | LR32159  | 420C9         | —  | LR701227 |
| 330C7       | —  | LR701227 | 3413PL    | —  | E135568  | 37101-90      | —  | LR32159  | 420C9W        | —  | LR701227 |
| 330C7W      | —  | LR701227 | 3413PL-20 | —  | E135568  | 37102-90      | —  | LR32159  | 420P12        | —  | LR701227 |
| 330M4       | —  | LR701227 | 3420-20   | —  | E135568  | 37103-90      | —  | LR32159  | 420P12W       | —  | LR701227 |
| 330M4W      | —  | LR701227 | 3420F     | —  | E135568  | 37104-90      | —  | LR32159  | 420P5         | —  | LR701227 |
| 330M5       | —  | LR701227 | 3420F-20  | —  | E135568  | 37105-90      | —  | LR32159  | 420P5W        | —  | LR701227 |
| 330M6       | —  | LR701227 | 3420FL    | —  | E135568  | 37106-90      | —  | LR32159  | 420P7         | —  | LR701227 |
| 330M6W      | —  | LR701227 | 3420FL-20 | —  | E135568  | 3762N         | —  | E10176   | 420P7W        | —  | LR701227 |
| 330M7       | —  | LR701227 | 3420L     | —  | E135568  | 3763N         | —  | E10176   | 420P9         | —  | LR701227 |
| 330M7W      | —  | LR701227 | 3420L-20  | —  | E135568  | 3764N         | —  | E10176   | 420P9W        | —  | LR701227 |
| 330P4       | —  | LR701227 | 3420P     | —  | E135568  | 3765N         | —  | E10176   | 420R12        | —  | LR701227 |
| 330P4W      | —  | LR701227 | 3420P-20  | —  | E135568  | 37W62         | —  | E10176   | 420R12W       | —  | LR701227 |
| 330P5       | —  | LR701227 | 3420PL    | —  | E135568  | 37W63         | —  | E10176   | 420R5         | —  | LR701227 |
| 330P5W      | —  | LR701227 | 3420PL-20 | —  | E135568  | 37W64         | —  | E10176   | 420R5W        | —  | LR701227 |
| 330P6       | —  | LR701227 | 3423-20   | —  | E135568  | 37W65         | —  | E10176   | 420R7         | —  | LR701227 |
| 330P6W      | —  | LR701227 | 3423F     | —  | E135568  | 4022-2        | —  | LR32400  | 420R7W        | —  | LR701227 |
| 330P7       | —  | LR701227 | 3423F-20  | —  | E135568  | 4022ES        | —  | LR32400  | 420R9         | —  | LR701227 |
| 330P7W      | —  | LR701227 | 3423FL    | —  | E135568  | 4023-2        | —  | LR32400  | 420R9W        | —  | LR701227 |
| 330R4       | —  | LR701227 | 3423FL-20 | —  | E135568  | 4023ES        | —  | LR32400  | 430BA5        | —  | LR701227 |
| 330R4W      | —  | LR701227 | 3423L     | —  | E135568  | 4024-2        | —  | LR32400  | 430BA5W       | —  | LR701227 |
| 330R5       | —  | LR701227 | 3423L-20  | —  | E135568  | 4024ES        | —  | LR32400  | 430BA7        | —  | LR701227 |
| 330R5W      | —  | LR701227 | 3423P     | —  | E135568  | 4026-2        | —  | LR32400  | 430BA7W       | —  | LR701227 |
| 330R6       | —  | LR701227 | 3423P-20  | —  | E135568  | 4026ES        | —  | LR32400  | 430BA9        | —  | LR701227 |
| 330R6W      | —  | LR701227 | 3423PL    | —  | E135568  | 4028-2        | —  | LR32400  | 430BA9W       | —  | LR701227 |
| 330R7       | —  | LR701227 | 3423PL-20 | —  | E135568  | 4028ES        | —  | LR32400  | 430C12        | —  | LR701227 |
| 330R7W      | —  | LR701227 | 342510A   | —  | LR39801  | 403000A10M020 | —  | E152210  | 430C12W       | —  | LR701227 |
| 3400-20     | —  | E135568  | 3500PLG   | —  | LR6837   | 403001A10M020 | —  | E152210  | 430C5         | —  | LR701227 |
| 3400F       | —  | E135568  | 3500S     | —  | E93230   | 403006A10M020 | —  | E152210  | 430C5W        | —  | LR701227 |
| 3400F-20    | —  | E135568  | 3500SPLG  | —  | LR6837   | 403007A10M020 | —  | E152210  | 430C7         | —  | LR701227 |
| 3400FL      | —  | E135568  | 3510PLG   | —  | LR6837   | 404000A10M020 | —  | E152210  | 430C7W        | —  | LR701227 |
| 3400FL-20   | —  | E135568  | 3510S     | —  | E93230   | 404001A10M020 | —  | E152210  | 430C9         | —  | LR701227 |
| 3400L       | —  | E135568  | 3510SPLG  | —  | LR6837   | 404006A10M020 | —  | E152210  | 430C9W        | —  | LR701227 |
| 3400L-20    | —  | E135568  | 35W07     | —  | LR6837   | 404007A10M020 | —  | E152210  | 430P12        | —  | LR701227 |
| 3400P       | —  | E135568  | 35W34     | —  | LR6837   | 405000A10M020 | —  | E152210  | 430P12W       | —  | LR701227 |
| 3400P-20    | —  | E135568  | 35W47     | —  | LR6837   | 405001A10M020 | —  | E152210  | 430P5         | —  | LR701227 |
| 3400PL      | —  | E135568  | 35W47A123 | —  | E38085   | 405006A10M020 | —  | E152210  | 430P5W        | —  | LR701227 |
| 3400PL-20   | —  | E135568  | 360BA4    | —  | LR701227 | 405007A10M020 | —  | E152210  | 430P7         | —  | LR701227 |
| 340310A     | —  | LR39801  | 360BA4W   | —  | LR701227 | 4052PC        | —  | LR32400  | 430P7W        | —  | LR701227 |
| 3403-20     | —  | E135568  | 360BA5    | —  | LR701227 | 4100B12W      | —  | LR701227 | 430P9         | —  | LR701227 |
| 3403F       | —  | E135568  | 360BA5W   | —  | LR701227 | 4100B5W       | —  | LR701227 | 430P9W        | —  | LR701227 |
| 3403F-20    | —  | E135568  | 360BA6    | —  | LR701227 | 4100B7W       | —  | LR701227 | 430R12        | —  | LR701227 |
| 3403FL      | —  | E135568  | 360BA6W   | —  | LR701227 | 4100B9W       | —  | LR701227 | 430R12W       | —  | LR701227 |
| 3403FL-20   | —  | E135568  | 360BA7    | —  | LR701227 | 4100C12W      | —  | LR701227 | 430R5         | —  | LR701227 |
| 3403L       | —  | E135568  | 360BA7W   | —  | LR701227 | 4100C5W       | —  | LR701227 | 430R5W        | —  | LR701227 |
| 3403L-20    | —  | E135568  | 360C4     | —  | LR701227 | 4100C7W       | —  | LR701227 | 430R7         | —  | LR701227 |
| 3403P       | —  | E135568  | 360C4W    | —  | LR701227 | 4100C9W       | —  | LR701227 | 430R7W        | —  | LR701227 |
| 3403P-20    | —  | E135568  | 360C5     | —  | LR701227 | 4100P12W      | —  | LR701227 | 430R9         | —  | LR701227 |
| 3403PL      | —  | E135568  | 360C5W    | —  | LR701227 | 4100P5W       | —  | LR701227 | 430R9W        | —  | LR701227 |
| 3403PL-20   | —  | E135568  | 360C6     | —  | LR701227 | 4100P7W       | —  | LR701227 | 440F          | —  | LR6837   |
| 340510A     | —  | LR39801  | 360C6W    | —  | LR701227 | 4100P9W       | —  | LR701227 | 443030A10M020 | —  | E152210  |





## UL/CSA APPROVALS BY PART NUMBER

| PART NO.      | UL      | CSA      | PART NO. | UL     | CSA      | PART NO. | UL     | CSA     | PART NO.  | UL     | CSA      |
|---------------|---------|----------|----------|--------|----------|----------|--------|---------|-----------|--------|----------|
| 443031A10M020 | E152210 | —        | 520R5W   | —      | LR701227 | 5530NM   | E76954 | LR32159 | 5558NM    | E76954 | LR32159  |
| 443032A10M020 | E152210 | —        | 520R7W   | —      | LR701227 | 5530W    | E76954 | LR32159 | 5558W     | E76954 | LR32159  |
| 443033A10M020 | E152210 | —        | 520R9W   | —      | LR701227 | 5531M    | —      | LR32159 | 5559M     | —      | LR32159  |
| 444030A10M020 | E152210 | —        | 5252DW   | E46237 | LR6837   | 5531NM   | E76954 | LR32159 | 5559NM    | E76954 | LR32159  |
| 444031A10M020 | E152210 | —        | 5261DW   | E46237 | —        | 5531W    | E76954 | LR32159 | 5559W     | E76954 | LR32159  |
| 444032A10M020 | E152210 | —        | 5262DW   | E46237 | LR6837   | 5532M    | —      | LR32159 | 5560M     | —      | LR32159  |
| 444033A10M020 | E152210 | —        | 5266-RB  | E10176 | E10176   | 5532W    | E76954 | LR32159 | 5560NM    | E76954 | LR32159  |
| 445030A10M020 | E152210 | —        | 5269-RB  | E10176 | E10176   | 5533M    | —      | LR32159 | 5560W     | E76954 | LR32159  |
| 445031A10M020 | E152210 | —        | 530BA5   | —      | LR701227 | 5533W    | E76954 | LR32159 | 5561M     | —      | LR32159  |
| 445032A10M020 | E152210 | —        | 530BA5W  | —      | LR701227 | 5534M    | —      | LR32159 | 5561NM    | E76954 | LR32159  |
| 445033A10M020 | E152210 | —        | 530BA7   | —      | LR701227 | 5534W    | E76954 | LR32159 | 5561W     | E76954 | LR32159  |
| 446F          | —       | LR6837   | 530BA7W  | —      | LR701227 | 5535M    | —      | LR32159 | 5562W     | E76954 | LR32159  |
| 460BA12       | —       | LR701227 | 530BA9   | —      | LR701227 | 5535W    | E76954 | LR32159 | 5563W     | E76954 | LR32159  |
| 460BA12W      | —       | LR701227 | 530BA9W  | —      | LR701227 | 5536NM   | E76954 | —       | 5580W     | —      | LR32159  |
| 460BA7        | —       | LR701227 | 530C5    | —      | LR701227 | 5536W    | E76954 | LR32159 | 5582W     | —      | LR32159  |
| 460BA7W       | —       | LR701227 | 530C5W   | —      | LR701227 | 5537NM   | E76954 | —       | 5594-004  | —      | LR32159  |
| 460BA9        | —       | LR701227 | 530C7    | —      | LR701227 | 5537W    | E76954 | LR32159 | 5594-004W | —      | LR32159  |
| 460BA9W       | —       | LR701227 | 530C7W   | —      | LR701227 | 5538NM   | E76954 | —       | 5594-005  | —      | LR32159  |
| 460C12        | —       | LR701227 | 530C9    | —      | LR701227 | 5538W    | E76954 | LR32159 | 5594-005W | —      | LR32159  |
| 460C12W       | —       | LR701227 | 530C9W   | —      | LR701227 | 5539NM   | E76954 | —       | 5594-006  | —      | LR32159  |
| 460C7         | —       | LR701227 | 530P5    | —      | LR701227 | 5539W    | E76954 | LR32159 | 5594-006W | —      | LR32159  |
| 460C7W        | —       | LR701227 | 530P5W   | —      | LR701227 | 5540NM   | E76954 | —       | 5594-007  | —      | LR32159  |
| 460C9         | —       | LR701227 | 530P7    | —      | LR701227 | 5540W    | E76954 | LR32159 | 5594-007W | —      | LR32159  |
| 460C9W        | —       | LR701227 | 530P7W   | —      | LR701227 | 5541NM   | E76954 | —       | 5594-008  | —      | LR32159  |
| 460P12        | —       | LR701227 | 530P9    | —      | LR701227 | 5541W    | E76954 | LR32159 | 5594-008W | —      | LR32159  |
| 460P12W       | —       | LR701227 | 530P9W   | —      | LR701227 | 5542NM   | E76954 | —       | 5595-004  | —      | LR32159  |
| 460P5         | —       | LR701227 | 530R5    | —      | LR701227 | 5542W    | E76954 | LR32159 | 5595-004W | —      | LR32159  |
| 460P5W        | —       | LR701227 | 530R5W   | —      | LR701227 | 5543NM   | E76954 | —       | 5595-005  | —      | LR32159  |
| 460P7         | —       | LR701227 | 530R7    | —      | LR701227 | 5543W    | E76954 | LR32159 | 5595-005W | —      | LR32159  |
| 460P7W        | —       | LR701227 | 530R7W   | —      | LR701227 | 5544W    | E76954 | LR32159 | 5595-006  | —      | LR32159  |
| 460P9         | —       | LR701227 | 530R9    | —      | LR701227 | 5545W    | E76954 | LR32159 | 5595-006W | —      | LR32159  |
| 460P9W        | —       | LR701227 | 530R9W   | —      | LR701227 | 5546M    | —      | LR32159 | 5595-007  | —      | LR32159  |
| 460R12        | —       | LR701227 | 5352DW   | E46237 | —        | 5546NM   | E76954 | LR32159 | 5595-007W | —      | LR32159  |
| 460R12W       | —       | LR701227 | 5361DW   | E46237 | —        | 5546W    | E76954 | LR32159 | 5595-008  | —      | LR32159  |
| 460R5         | —       | LR701227 | 5362DW   | E46237 | —        | 5547M    | —      | LR32159 | 5595-008W | —      | LR32159  |
| 460R5W        | —       | LR701227 | 5366-RB  | E10176 | E10176   | 5547NM   | E76954 | LR32159 | 560BA7    | —      | LR701227 |
| 460R7         | —       | LR701227 | 5369-RB  | E10176 | E10176   | 5547W    | E76954 | LR32159 | 560BA7W   | —      | LR701227 |
| 460R7W        | —       | LR701227 | 5452DW   | E46237 | —        | 5548M    | —      | LR32159 | 560BA9    | —      | LR701227 |
| 460R9         | —       | LR701227 | 5462DW   | E46237 | —        | 5548NM   | E76954 | LR32159 | 560BA9W   | —      | LR701227 |
| 460R9W        | —       | LR701227 | 5518W    | —      | LR32159  | 5548W    | E76954 | LR32159 | 560C7     | —      | LR701227 |
| 4700DW        | —       | AP49707  | 5519W    | —      | LR32159  | 5549M    | —      | LR32159 | 560C7W    | —      | LR701227 |
| 4R3P00A27C300 | E152210 | —        | 5520W    | E76954 | LR32159  | 5549NM   | E76954 | LR32159 | 560C9     | —      | LR701227 |
| 4R3P06A27C300 | E152210 | —        | 5521W    | E76954 | LR32159  | 5549W    | E76954 | LR32159 | 560C9W    | —      | LR701227 |
| 4R4P00A27C300 | E152210 | —        | 5522M    | —      | LR32159  | 5550M    | —      | LR32159 | 560P5     | —      | LR701227 |
| 4R4P06A27C300 | E152210 | —        | 5522NM   | E76954 | LR32159  | 5550NM   | E76954 | LR32159 | 560P5W    | —      | LR701227 |
| 4R5P00A27C300 | E152210 | —        | 5522W    | E76954 | LR32159  | 5550W    | E76954 | LR32159 | 560P7     | —      | LR701227 |
| 4R5P06A27C300 | E152210 | —        | 5523M    | —      | LR32159  | 5551M    | —      | LR32159 | 560P7W    | —      | LR701227 |
| 5100B5W       | —       | LR701227 | 5523NM   | E76954 | LR32159  | 5551NM   | E76954 | LR32159 | 560P9     | —      | LR701227 |
| 5100B7W       | —       | LR701227 | 5523W    | E76954 | LR32159  | 5551W    | E76954 | LR32159 | 560P9W    | —      | LR701227 |
| 5100B9W       | —       | LR701227 | 5524M    | —      | LR32159  | 5552M    | —      | LR32159 | 560R5     | —      | LR701227 |
| 5100C5W       | —       | LR701227 | 5524NM   | E76954 | LR32159  | 5552NM   | E76954 | LR32159 | 560R5W    | —      | LR701227 |
| 5100C7W       | —       | LR701227 | 5524W    | E76954 | LR32159  | 5552W    | E76954 | LR32159 | 560R7     | —      | LR701227 |
| 5100C9W       | —       | LR701227 | 5525M    | —      | LR32159  | 5553M    | —      | LR32159 | 560R7W    | —      | LR701227 |
| 5100P5W       | —       | LR701227 | 5525NM   | E76954 | LR32159  | 5553NM   | E76954 | LR32159 | 560R9     | —      | LR701227 |
| 5100P7W       | —       | LR701227 | 5525W    | E76954 | LR32159  | 5553W    | E76954 | LR32159 | 560R9W    | —      | LR701227 |
| 5100P9W       | —       | LR701227 | 5526M    | —      | LR32159  | 5554M    | —      | LR32159 | 5620M     | —      | LR32159  |
| 5100R5W       | —       | LR701227 | 5526NM   | E76954 | LR32159  | 5554NM   | E76954 | LR32159 | 5620NM    | E76954 | LR32159  |
| 5100R7W       | —       | LR701227 | 5526W    | E76954 | LR32159  | 5554W    | E76954 | LR32159 | 5620W     | E76954 | LR32159  |
| 5100R9W       | —       | LR701227 | 5527M    | —      | LR32159  | 5555M    | —      | LR32159 | 5621M     | E76954 | LR32159  |
| 520BA5W       | —       | LR701227 | 5527NM   | E76954 | LR32159  | 5555NM   | E76954 | LR32159 | 5621NM    | E76954 | LR32159  |
| 520BA7W       | —       | LR701227 | 5527W    | E76954 | LR32159  | 5555W    | E76954 | LR32159 | 5621W     | E76954 | LR32159  |
| 520BA9W       | —       | LR701227 | 5528M    | —      | LR32159  | 5556M    | —      | LR32159 | 5622M     | —      | LR32159  |
| 520C5W        | —       | LR701227 | 5528NM   | E76954 | LR32159  | 5556NM   | E76954 | LR32159 | 5622NM    | E76954 | LR32159  |
| 520C7W        | —       | LR701227 | 5528W    | E76954 | LR32159  | 5556W    | E76954 | LR32159 | 5622W     | E76954 | LR32159  |
| 520C9W        | —       | LR701227 | 5529M    | —      | LR32159  | 5557M    | —      | LR32159 | 5623M     | —      | LR32159  |
| 520P5W        | —       | LR701227 | 5529NM   | E76954 | LR32159  | 5557NM   | E76954 | LR32159 | 5623NM    | E76954 | LR32159  |
| 520P7W        | —       | LR701227 | 5529W    | E76954 | LR32159  | 5557W    | E76954 | LR32159 | 5623W     | E76954 | LR32159  |
| 520P9W        | —       | LR701227 | 5530M    | —      | LR32159  | 5558M    | —      | LR32159 | 5624M     | —      | LR32159  |



UL/CSA APPROVALS BY PART NUMBER

| PART NO.  | UL     | CSA     | PART NO.      | UL      | CSA      | PART NO.      | UL      | CSA     | PART NO.      | UL      | CSA     |
|-----------|--------|---------|---------------|---------|----------|---------------|---------|---------|---------------|---------|---------|
| 5624NM    | E76954 | LR32159 | 69W74         | E68122  | LR6837   | 92433-3070G   | —       | LR29921 | C04001A48M005 | E152210 | E152210 |
| 5624W     | E76954 | LR32159 | 69W75         | E68122  | LR6837   | 92433-3080    | —       | LR29921 | C04006A48M005 | E152210 | E152210 |
| 5625M     | —      | LR32159 | 69W76         | E68122  | LR6837   | 92501AN       | —       | LR29921 | C04007A48M005 | E152210 | E152210 |
| 5625NM    | E76954 | LR32159 | 69W77         | E68122  | —        | 92502N        | —       | LR29921 | C04100A48M005 | E152210 | E152210 |
| 5625W     | E76954 | LR32159 | 69W81         | E68122  | —        | 92511AN       | —       | LR29921 | C04101A48M005 | E152210 | E152210 |
| 5652DW    | E46237 | LR6837  | 69W82         | E68122  | —        | 92512AN       | —       | LR29921 | C04106A48M005 | E152210 | E152210 |
| 5662DW    | E46237 | LR6837  | 69W83         | E68122  | —        | 92512BN       | —       | LR29921 | C04107A48M005 | E152210 | E152210 |
| 600SC     | —      | LR1533  | 803000A09M020 | E152210 | —        | 92526AN       | —       | LR29921 | CC3030A48M005 | E152210 | E152210 |
| 60W04     | E68122 | —       | 803001A09M020 | E152210 | —        | 92526BN       | —       | LR29921 | CC3031A48M005 | E152210 | E152210 |
| 60W04DPLX | —      | LR6837  | 803006A09M020 | E152210 | —        | 9253-106US    | E22769  | LR85374 | CC3032A48M005 | E152210 | E152210 |
| 60W07DPLX | —      | LR6837  | 803007A09M020 | E152210 | —        | 9253-1547     | E22769  | LR29921 | CC3033A48M005 | E152210 | E152210 |
| 60W33     | E68122 | —       | 804000A09M020 | E152210 | —        | 92531N        | —       | LR29921 | CC3130A48M005 | E152210 | E152210 |
| 60W33DPLX | —      | LR6837  | 804001A09M020 | E152210 | —        | 92532N        | —       | LR29921 | CC3131A48M005 | E152210 | E152210 |
| 60W34     | E68122 | LR6837  | 804006A09M020 | E152210 | —        | 9253-3000     | E22769  | LR29921 | CC3132A48M005 | E152210 | E152210 |
| 60W34DPLX | —      | LR6837  | 804007A09M020 | E152210 | —        | 9253-3070G    | —       | LR29921 | CC3133A48M005 | E152210 | E152210 |
| 60W47     | E68122 | LR6837  | 805000A09M020 | E152210 | —        | 92533N        | —       | LR29921 | CC4030A48M005 | E152210 | E152210 |
| 60W47DPLX | —      | LR6837  | 805001A09M020 | E152210 | —        | 92534N        | —       | LR29921 | CC4031A48M005 | E152210 | E152210 |
| 60W48     | E68122 | —       | 805006A09M020 | E152210 | —        | 92535AN       | —       | LR29921 | CC4032A48M005 | E152210 | E152210 |
| 60W48DPLX | —      | LR6837  | 805007A09M020 | E152210 | —        | 92535BN       | —       | LR29921 | CC4033A48M005 | E152210 | E152210 |
| 60W49     | E68122 | LR6837  | 8506M         | —       | LL85374  | 92536N        | —       | LR29921 | CC4130A48M005 | E152210 | E152210 |
| 60W49DPLX | —      | LR6837  | 8540M         | LL85374 | LL85374  | 92541N        | —       | LR29921 | CC4131A48M005 | E152210 | E152210 |
| 60W64     | E68122 | —       | 8540P         | LL85374 | LL85374  | 92542N        | —       | LR29921 | CC4132A48M005 | E152210 | E152210 |
| 61430A163 | E30252 | —       | 8565F         | E174254 | —        | 92543N        | —       | LR29921 | CC4133A48M005 | E152210 | E152210 |
| 61430B163 | E30252 | —       | 8565F-MH      | E174254 | —        | 92544AN       | —       | LR29921 | CR3000A30M005 | E152210 | E152210 |
| 61430D163 | E30252 | —       | 8565-MH       | E174254 | —        | 92544BN       | —       | LR29921 | CR3006A30M005 | E152210 | E152210 |
| 6360CRN   | E10176 | —       | 8570P-56      | —       | LR701559 | 92545AN       | —       | LR29921 | CR3100A30M005 | E152210 | E152210 |
| 6361CRN   | E10176 | —       | 8570P-56A163  | E174254 | LR701559 | 92546N        | —       | LR29921 | CR3106A30M005 | E152210 | E152210 |
| 6364CRN   | E10176 | —       | 8570P-56B163  | E174254 | LR701559 | 92561N        | —       | LR29921 | CR3C00A30M005 | E152210 | E152210 |
| 6365CRN   | E10176 | —       | 8570P-56D163  | E174254 | LR701559 | 92562AN       | —       | LR29921 | CR3C06A30M005 | E152210 | E152210 |
| 63W60     | E10176 | —       | 883030A09M020 | E152210 | —        | 92562BN       | —       | LR29921 | CR3D00A30M005 | E152210 | E152210 |
| 63W61     | E10176 | —       | 883031A09M020 | E152210 | —        | 92564N        | —       | LR29921 | CR3D06A30M005 | E152210 | E152210 |
| 63W64     | E10176 | —       | 883032A09M020 | E152210 | —        | 92581N        | —       | LR29921 | CR4000A30M005 | E152210 | E152210 |
| 63W65     | E10176 | —       | 883033A09M020 | E152210 | —        | 92582N        | —       | LR29921 | CR4006A30M005 | E152210 | E152210 |
| 64W64     | E68122 | —       | 884030A09M020 | E152210 | —        | 92583N        | —       | LR29921 | CR4100A30M005 | E152210 | E152210 |
| 65W04     | E68122 | LR6837  | 884031A09M020 | E152210 | —        | 92584N        | —       | LR29921 | CR4106A30M005 | E152210 | E152210 |
| 65W04DPLX | —      | LR6837  | 884032A09M020 | E152210 | —        | 9383-1533     | E22769  | LR29921 | CR4C00A30M005 | E152210 | E152210 |
| 65W07DPLX | —      | LR6837  | 884033A09M020 | E152210 | —        | 9383-1547     | E22769  | LR29921 | CR4C06A30M005 | E152210 | E152210 |
| 65W34     | E68122 | LR6837  | 885030A09M020 | E152210 | —        | 9383-3000     | E22769  | LR29921 | CR4D00A30M005 | E152210 | E152210 |
| 65W34DPLX | —      | LR6837  | 885031A09M020 | E152210 | —        | 9383-3070G    | —       | LR29921 | CR4D06A30M005 | E152210 | E152210 |
| 65W47     | E68122 | LR6837  | 885032A09M020 | E152210 | —        | 9383-3080     | E22769  | LR29921 | CS60W64       | E68122  | —       |
| 65W47DPLX | —      | LR6837  | 885033A09M020 | E152210 | —        | 945-1547      | E22769  | —       | CS6364N       | —       | E10176  |
| 65W49     | E68122 | —       | 8A4000-31     | LR06837 | LR6837   | 945-3         | E22769  | —       | CS6365N       | —       | E10176  |
| 65W49DPLX | —      | LR6837  | 8A4000-32     | LR06837 | LR6837   | 945-3-86      | E22769  | —       | CS63W60       | —       | E10176  |
| 65W64     | E68122 | —       | 8A4001-31     | LR06837 | LR6837   | 980-106US     | E22769  | —       | CS63W61       | —       | E10176  |
| 66W64     | E68122 | —       | 8A4006-31     | LR06837 | LR6837   | 980-1547      | E22769  | —       | CS63W64       | —       | E10176  |
| 67W07     | E68122 | LR6837  | 8A4006-32     | LR06837 | LR6837   | 980-3000      | E22769  | —       | CS63W65       | —       | E10176  |
| 67W07DPLX | —      | LR6837  | 8A4007-31     | LR06837 | LR6837   | 980-83        | E22769  | —       | CS69W60       | E68122  | —       |
| 67W08     | E68122 | —       | 8A5000-31     | LR06837 | LR6837   | 980-86        | E22769  | —       | CS81W64       | —       | E10176  |
| 67W09     | E68122 | —       | 8A5000-32     | LR06837 | LR6837   | 980A-118      | E22769  | —       | CS81W65       | —       | E10176  |
| 67W10     | E68122 | —       | 8A5001-31     | LR06837 | LR6837   | 980A-83       | E22769  | —       | CS8264N       | —       | E10176  |
| 67W47     | E68122 | LR6837  | 8A5006-31     | LR06837 | LR6837   | 990-106US     | E22769  | —       | CS8265N       | —       | E10176  |
| 67W48     | E68122 | LR6837  | 8A5006-32     | LR06837 | LR6837   | 990-1547      | E22769  | —       | CS82W64       | —       | E10176  |
| 67W49     | E68122 | LR6837  | 8A5007-31     | LR06837 | LR6837   | 990-271US     | E22769  | —       | CS82W65       | —       | E10176  |
| 67W64     | E68122 | —       | 8R3006A18A120 | E152210 | —        | 990-3000      | E22769  | —       | CS83W65       | —       | E10176  |
| 67W74     | E68122 | LR6837  | 8R3A00A18A120 | E152210 | —        | 990-83        | E22769  | —       | CS84W64       | —       | E10176  |
| 67W75     | E68122 | LR6837  | 8R4006A18A120 | E152210 | —        | 990-86        | E22769  | —       | CS84W65       | —       | E10176  |
| 67W76     | E68122 | LR6837  | 8R4A00A18A120 | E152210 | —        | 990A-118      | E22769  | —       | SBG2500       | —       | LL85374 |
| 67W81     | E68122 | —       | 8R5006A18A120 | E152210 | —        | 990A-83       | E22769  | —       | SBS2500       | —       | —       |
| 67W82     | E68122 | —       | 8R5A00A18A120 | E152210 | —        | 997-3000      | E22769  | —       | WT3C-20       | E59049  | E59049  |
| 67W83     | E68122 | —       | 9224-106US    | E22769  | LL85374  | C03000A48M005 | E152210 | E152210 | WT3F-20       | E59049  | E59049  |
| 69W08     | E68122 | —       | 9224-1547     | E22769  | LR29921  | C03001A48M005 | E152210 | E152210 | WTC6-25       | E59049  | E59049  |
| 69W09     | E68122 | —       | 9224-86       | E22769  | —        | C03006A48M005 | E152210 | E152210 | WTC6-50       | E59049  | E59049  |
| 69W47     | E68122 | LR6837  | 9228-106US    | E22769  | —        | C03007A48M005 | E152210 | E152210 | WT6F-25       | E59049  | E59049  |
| 69W48     | E68122 | LR6837  | 9228-1547     | E22769  | LR29921  | C03100A48M005 | E152210 | E152210 | WT6F-50       | E59049  | E59049  |
| 69W49     | E68122 | LR6837  | 9228-86       | E22769  | —        | C03101A48M005 | E152210 | E152210 | —             | —       | —       |
| 69W60     | E68122 | —       | 92433-1533    | —       | LR29921  | C03106A48M005 | E152210 | E152210 | —             | —       | —       |
| 69W62     | E68122 | —       | 92433-1547    | —       | LR29921  | C03107A48M005 | E152210 | E152210 | —             | —       | —       |
| 69W64     | E68122 | —       | 92433-3000    | —       | LR29921  | C04000A48M005 | E152210 | E152210 | —             | —       | —       |

# APPENDIX

## ALPHANUMERIC LISTING OF PART NUMBERS

| PART NO. | PAGE               | PART NO.      | PAGE          | PART NO.       | PAGE | PART NO.        | PAGE |
|----------|--------------------|---------------|---------------|----------------|------|-----------------|------|
| 00-0820  | 160                | 00-5267       | 123, 157, 159 | 105003A01F030  | 222  | 106US           | 14   |
| 00-0822  | 160                | 00136         | 122           | 1051-12        | 33   | 106USA163       | 14   |
| 00-0824  | 160                | 00137         | 122           | 1051-PL        | 32   | 106USB163       | 14   |
| 00-0920  | 156                | 00380         | 122           | 1051-PL12      | 33   | 1083-3          | 16   |
| 00-0921  | 156                | 00382         | 122           | 1051__303      | 205  | 1083-3-E        | 16   |
| 00-0922  | 156                | 08336         | 210           | 1051__304      | 205  | 1083-3-P        | 16   |
| 00-1470  | 7                  | 095104203     | 194           | 1051__306      | 205  | 1083-3B         | 17   |
| 00-1480  | 7                  | 095104204     | 194           | 1051__308      | 205  | 1083-3B12       | 17   |
| 00-1490  | 7                  | 095104206     | 194           | 1051__310      | 205  | 1083-3BD        | 17   |
| 00-1921  | 160                | 095104208     | 194           | 1051__312      | 205  | 1083-3BL        | 17   |
| 00-1922  | 160                | 095105203     | 194           | 1051__402      | 205  | 1083-3BP        | 17   |
| 00-1923  | 160                | 095105204     | 194           | 1051__403      | 205  | 1083-3BP12      | 17   |
| 00-1924  | 160                | 095105206     | 194           | 1051__404      | 205  | 1083-3HON       | 16   |
| 00-1925  | 160                | 095105208     | 194           | 10511303GOL000 | 198  | 1083-3HONS      | 16   |
| 00-4140  | 41                 | 095106203     | 194           | 10511304GOL00  | 198  | 1083-3M         | 42   |
| 00-4180  | 41                 | 095106204     | 194           | 10511304GOL000 | 198  | 1083-3M-P       | 42   |
| 00-4940  | 160                | 095106206     | 194           | 10511306GOL000 | 198  | 1083-3MM        | 42   |
| 00-4941  | 160                | 095106208     | 194           | 10511308GOL000 | 198  | 1083-3MM-24     | 42   |
| 00-4950  | 160                | 095106210     | 194           | 10511310GOL000 | 198  | 1083-3NS        | 16   |
| 00-4951  | 160                | 095106212     | 194           | 10511312GOL000 | 198  | 1085-3          | 16   |
| 00-4960  | 156, 158           | 1003-3        | 18            | 1051140200L000 | 198  | 1085-3-P        | 16   |
| 00-4961  | 156, 158           | 1003-3-P      | 18            | 10511403GOL000 | 198  | 1085-3NS        | 16   |
| 00-4962  | 156, 158           | 1003-3HO      | 18            | 10511404GOL000 | 198  | 1086-3          | 16   |
| 00-4963  | 156, 158           | 1005-3        | 18            | 10512303GOL000 | 198  | 1086-3-E        | 16   |
| 00-4964  | 156, 158           | 1013-3        | 18            | 10512304GOL000 | 198  | 1086-3HO        | 16   |
| 00-4965  | 156, 158           | 1015-3        | 18            | 10512306GOL000 | 198  | 1086-3NS        | 16   |
| 00-4970  | 123, 157, 159      | 102000A01F030 | 222           | 10512308GOL000 | 198  | 1086LC          | 16   |
| 00-4971  | 123, 157, 159      | 102001A01F030 | 222           | 10512310GOL000 | 198  | 1087-3          | 16   |
| 00-4972  | 123, 157, 159      | 102002A01F030 | 222           | 10512312GOL000 | 198  | 1087-3-E        | 16   |
| 00-4975  | 123, 157, 159      | 102003A01F030 | 222           | 1051240200L000 | 198  | 1087-3NS        | 16   |
| 00-4978  | 123, 157, 159      | 1026-12       | 33            | 10512403GOL000 | 198  | 1090-HZ         | 7    |
| 00-4980  | 123, 145, 157, 159 | 103000A01F030 | 222           | 10513306GOL000 | 198  | 1090-HZ12A163   | 7    |
|          |                    | 103000A45M010 | 242           | 1051340200L000 | 198  | 1090-HZ12B163   | 7    |
| 00-4981  | 123, 145, 157, 159 | 103000A46M010 | 242           | 10513403GOL000 | 198  | 1090-HZ12IA163  | 7    |
|          |                    | 103001A01F030 | 222           | 10513404GOL000 | 198  | 1090-HZ12IB163  | 7    |
| 00-4982  | 123, 145, 157, 159 | 103001A45M010 | 242           | 1052-12        | 33   | 1090-HZ12IB163P | 7    |
|          |                    | 103001A46M010 | 242           | 1052-PL        | 32   | 1090-HZ12ID143  | 7    |
| 00-4983  | 123, 145, 157, 159 | 103002A01F030 | 222           | 1052-PL12      | 33   | 1090-HZ12ID143P | 7    |
|          |                    | 103003A01F030 | 222           | 105A163        | 14   | 1090-HZA163     | 7    |
| 00-4984  | 123, 145, 157, 159 | 103006A45M010 | 242           | 105B163        | 14   | 1090-HZB163     | 7    |
|          |                    | 103006A46M010 | 242           | 105S           | 14   | 1090-HZD163     | 7    |
| 00-4985  | 123, 145, 157, 159 | 103007A45M010 | 242           | 105SA163       | 14   | 1093-3          | 16   |
|          |                    | 103007A46M010 | 242           | 105SB163       | 14   | 1093-3-E        | 16   |
| 00-4986  | 123, 145, 157, 159 | 104000A01F030 | 222           | 105U           | 14   | 1093-3M         | 42   |
|          |                    | 104000A45M010 | 242           | 105UA163       | 14   | 1093-3MM        | 42   |
| 00-4987  | 123, 145, 157, 159 | 104000A46M010 | 242           | 105UB163       | 14   | 1095-3          | 16   |
|          |                    | 104001A01F030 | 222           | 105US          | 14   | 1097-3          | 16   |
| 00-4990  | 123, 157, 159      | 104001A45M010 | 242           | 105USA163      | 14   | 1097-3-E        | 16   |
| 00-4991  | 123, 157, 159      | 104001A46M010 | 242           | 105USB163      | 14   | 1097-3M         | 42   |
| 00-4992  | 123, 157, 159      | 104002A01F030 | 222           | 106            | 14   | 1097-3MM        | 42   |
| 00-4993  | 123, 157, 159      | 104003A01F030 | 222           | 1060-PL        | 32   | 1099-3          | 16   |
| 00-4994  | 123, 157, 159      | 104006A45M010 | 242           | 106000A01F030  | 222  | 1099-3-E        | 16   |
| 00-4995  | 123, 157, 159      | 104006A46M010 | 242           | 106001A01F030  | 222  | 112020A01F030   | 222  |
| 00-4996  | 123, 157, 159      | 104007A45M010 | 242           | 106002A01F030  | 222  | 112021A01F030   | 222  |
| 00-4997  | 123, 157, 159      | 104007A46M010 | 242           | 106003A01F030  | 222  | 112022A01F030   | 222  |
| 00-4998  | 123, 157, 159      | 1045          | 18            | 1061-PL        | 32   | 112023A01F030   | 222  |
| 00-5070  | 123, 157, 159      | 1049          | 18            | 1062-PL        | 32   | 113020A01F030   | 222  |
| 00-5071  | 123, 157, 159      | 105           | 14            | 106A163        | 14   | 113021A01F030   | 222  |
| 00-5072  | 123, 157, 159      | 1050-12       | 33            | 106B163        | 14   | 113022A01F030   | 222  |
| 00-5073  | 123, 157, 159      | 1050-PL       | 32            | 106S           | 14   | 113023A01F030   | 222  |
| 00-5074  | 123, 157, 159      | 1050-PL12     | 33            | 106SA163       | 14   | 113030A45M010   | 242  |
| 00-5150  | 211                | 105000A01F030 | 222           | 106SB163       | 14   | 113030A46M010   | 242  |
| 00-5263  | 123, 157, 159      | 105001A01F030 | 222           | 106U           | 14   | 113031A45M010   | 242  |
| 00-5264  | 123, 157, 159      | 105002A01F030 | 222           | 106UA163       | 14   | 113031A46M010   | 242  |
| 00-5266  | 123, 157, 159      | 105002A01F060 | 211           | 106UB163       | 14   | 113032A45M010   | 242  |

## ALPHANUMERIC LISTING OF PART NUMBERS

| PART NO.      | PAGE   | PART NO.     | PAGE   | PART NO.  | PAGE   | PART NO.   | PAGE   |
|---------------|--------|--------------|--------|-----------|--------|------------|--------|
| 113032A46M010 | 242    | 1165__310    | 205    | 1207RA163 | 9      | 1433-W-IN  | 79     |
| 113033A45M010 | 242    | 1165__312    | 205    | 1207RB163 | 9      | 1433-Y     | 79     |
| 113033A46M010 | 242    | 1165__402    | 205    | 1207RGC   | 9      | 1433-Y-IN  | 79     |
| 1133          | 15     | 1165__403    | 205    | 1220      | 9      | 1433EZ     | 74     |
| 1134          | 15     | 1165__404    | 205    | 1223      | 9      | 1433MB     | 46, 77 |
| 1135U         | 15     | 116505303G1L | 199    | 1225      | 9      | 1433_123   | 78     |
| 1135US        | 15     | 116505303G2L | 199    | 1229      | 11     | 1433_143   | 78     |
| 114020A01F030 | 222    | 116505304G1L | 199    | 1253      | 11     | 1434       | 46, 61 |
| 114021A01F030 | 222    | 116505304G2L | 199    | 1255      | 11     | 1434MB     | 46, 62 |
| 114022A01F030 | 222    | 116505306G1L | 199    | 1255IG    | 11     | 1434_143   | 63     |
| 114023A01F030 | 222    | 116505306G2L | 199    | 1255R     | 11     | 1434_163   | 63     |
| 114030A45M010 | 242    | 116505306G3L | 199    | 1255RIG   | 11     | 1447       | 46, 53 |
| 114030A46M010 | 242    | 116505308G1L | 199    | 1257      | 11     | 1447-W     | 59     |
| 114031A45M010 | 242    | 116505308G2L | 199    | 1257R     | 11     | 1447-W-IN  | 59     |
| 114031A46M010 | 242    | 116505308G3L | 199    | 1259      | 11     | 1447-Y     | 59     |
| 114032A45M010 | 242    | 116505308G4L | 199    | 1259R     | 11     | 1447-Y-IN  | 59     |
| 114032A46M010 | 242    | 116505310G3L | 199    | 1261      | 11     | 1447EZ     | 54     |
| 114033A45M010 | 242    | 116505312G3L | 199    | 1261GC    | 11     | 1447MB     | 46, 57 |
| 114033A46M010 | 242    | 116505402J3L | 199    | 1262      | 43     | 1447_143   | 58     |
| 1143          | 15     | 116505402J4L | 199    | 1278      | 11     | 1447_163   | 58     |
| 1143__303     | 205    | 116505403G4L | 199    | 1324      | 32     | 1448       | 46, 85 |
| 1143__304     | 205    | 116505403G5L | 199    | 1324-E    | 32     | 1448-W     | 87     |
| 1143__306     | 205    | 116505404G5L | 199    | 1324-P    | 32     | 1448-W-IN  | 87     |
| 1143__308     | 205    | 116505404G6L | 199    | 1326      | 32     | 1448-Y     | 87     |
| 1143__402     | 205    | 1165IG       | 15, 21 | 1334      | 32     | 1448-Y-IN  | 87     |
| 114310303G0L  | 199    | 1166         | 15, 21 | 1334-E    | 32     | 1448MB     | 46, 86 |
| 114310303G1L  | 199    | 1168         | 15, 21 | 1335      | 32     | 1448_123   | 87     |
| 114310304G0L  | 199    | 1173         | 15     | 1336      | 32     | 1448_143   | 87     |
| 114310304G1L  | 199    | 1174         | 15     | 1336-E    | 32     | 1449       | 46, 61 |
| 114310304G2L  | 199    | 1175U        | 15     | 1336-P    | 32     | 1449MB     | 46, 62 |
| 114310306G1L  | 199    | 1175US       | 15     | 1337      | 32     | 1449_143   | 63     |
| 114310308G1L  | 199    | 1181         | 15, 21 | 1350      | 32     | 1449_163   | 63     |
| 114310402J3L  | 199    | 1203         | 8      | 1351      | 32     | 14F47      | 55     |
| 1144          | 15     | 1203A163     | 8      | 1351-E    | 32     | 14R33      | 75     |
| 1145U         | 15     | 1203B163     | 8      | 1352      | 32     | 14R47      | 55     |
| 1145US        | 15     | 1203GC       | 8      | 1352-E    | 32     | 14W04      | 46, 48 |
| 115020A01F030 | 222    | 1203I        | 9      | 140003    | 217    | 14W04_142  | 51     |
| 115021A01F030 | 222    | 1203IA163    | 9      | 140006    | 217    | 14W04_162  | 51     |
| 115022A01F030 | 222    | 1203IB163    | 9      | 1404      | 46, 49 | 14W07      | 46, 64 |
| 115023A01F030 | 222    | 1203IGC      | 9      | 1404MB    | 46, 50 | 14W07_143  | 67     |
| 1152          | 15, 21 | 1203P        | 8      | 1404_142  | 51     | 14W07_163  | 67     |
| 1152IG        | 15, 21 | 1203PQ0A163  | 8      | 1404_162  | 51     | 14W19      | 46, 48 |
| 1153          | 15, 21 | 1203PQ0B143  | 8      | 1407      | 46, 65 | 14W33      | 46, 72 |
| 1153IG        | 15, 21 | 1203PRI      | 9      | 1407MB    | 46, 66 | 14W33-W    | 79     |
| 1156          | 15, 21 | 1203Q0       | 8      | 1407_143  | 67     | 14W33-W-IN | 79     |
| 1156IG        | 15, 21 | 1203Q0A163   | 8      | 1407_163  | 67     | 14W33-Y    | 79     |
| 1157          | 15, 21 | 1203Q0B163   | 8      | 141003    | 217    | 14W33-Y-IN | 79     |
| 1157IG        | 15, 21 | 1203Q0GC     | 8      | 141006    | 217    | 14W33EZ    | 74     |
| 1160          | 15, 21 | 1203R        | 8      | 141103    | 217    | 14W33_123  | 78     |
| 116020A01F030 | 222    | 1203RA163    | 8      | 141106    | 217    | 14W33_143  | 78     |
| 116021A01F030 | 222    | 1203RA163P   | 9      | 141203    | 217    | 14W34      | 46, 60 |
| 116022A01F030 | 222    | 1203RB163    | 8      | 141206    | 217    | 14W34_143  | 63     |
| 116023A01F030 | 222    | 1203RB163P   | 9      | 141303    | 217    | 14W34_163  | 63     |
| 1160IG        | 15, 21 | 1203RGC      | 8      | 141306    | 217    | 14W47      | 46, 52 |
| 1161          | 15, 21 | 1203RI       | 8      | 1419      | 46, 49 | 14W47-Y    | 59     |
| 1161IG        | 15, 21 | 1203RIA163   | 8      | 142003    | 217    | 14W47-Y-IN | 59     |
| 1162          | 15, 21 | 1203RIB163   | 8      | 142006    | 217    | 14W47EZ    | 54     |
| 1162IG        | 15, 21 | 1203RIGC     | 8      | 143025    | 216    | 14W47_143  | 58     |
| 1164          | 15, 21 | 1207         | 9      | 143025NC  | 216    | 14W47_163  | 58     |
| 1164IG        | 15, 21 | 1207A163     | 9      | 143050    | 216    | 14W48      | 46, 84 |
| 1165          | 15, 21 | 1207B163     | 9      | 143050NC  | 216    | 14W48-W    | 87     |
| 1165__303     | 205    | 1207GC       | 9      | 143050SS  | 216    | 14W48-W-IN | 87     |
| 1165__304     | 205    | 1207P        | 9      | 143051    | 216    | 14W48-Y    | 87     |
| 1165__306     | 205    | 1207PRB163   | 9      | 1433      | 46, 73 | 14W48-Y-IN | 87     |
| 1165__308     | 205    | 1207R        | 9      | 1433-W    | 79     | 14W48_123  | 87     |



MOST WOODHEAD PRODUCTS HAVE U.L. AND/OR CSA APPROVALS.  
FOR A LISTING OF APPROVALS BY PART NUMBER, SEE PAGES 248-257.

# APPENDIX

## ALPHANUMERIC LISTING OF PART NUMBERS

| PART NO.   | PAGE   | PART NO.   | PAGE      | PART NO.       | PAGE     | PART NO.   | PAGE   |
|------------|--------|------------|-----------|----------------|----------|------------|--------|
| 14W48_143  | 87     | 1610       | 41        | 1913SHO        | 19       | 20055-6    | 132    |
| 14W49      | 46, 60 | 1610S      | 41        | 1926SA         | 19       | 2010       | 27     |
| 14W49_143  | 63     | 1612       | 41        | 1926SB         | 19       | 2011       | 27     |
| 14W49_163  | 63     | 1612S      | 41        | 1926SHO        | 19       | 2012       | 27     |
| 150        | 43     | 1621-12A   | 10        | 1940SA         | 19       | 202SRL     | 39     |
| 1504       | 46, 49 | 1621-12B   | 10        | 1940SB         | 19       | 2030       | 27     |
| 1504MB     | 46, 50 | 1621-12B-P | 10        | 1940SHO        | 19       | 2030PLX25  | 26     |
| 15050-1    | 132    | 1625-12A   | 10        | 1A3000-34      | 224      | 2030PLX50  | 26     |
| 15050-25   | 132    | 1625-12B   | 10        | 1A3002-34      | 224      | 2031       | 27     |
| 15050-25TT | 132    | 1631-12A   | 10        | 1A3006-34      | 224      | 2031-P     | 27     |
| 15050-3TT  | 132    | 1631-12B   | 10        | 1A4000-34      | 224      | 2032       | 27     |
| 15050-50TT | 132    | 1635-12A   | 6         | 1A4002-34      | 224      | 2113GS     | 42     |
| 15050-6    | 132    | 1635-12B   | 6         | 1A4006-34      | 224      | 2113MS     | 42     |
| 15050-6TT  | 132    | 1638-12    | 41        | 1A5000-34      | 224      | 2113S      | 42     |
| 15051-1    | 132    | 1639-12    | 41        | 1A5002-34      | 224      | 2126GS     | 42     |
| 15051-25   | 132    | 1640-12    | 13        | 1A5006-34      | 224      | 2126MS     | 42     |
| 15051-6    | 132    | 1641-12    | 13        | 1C3030-001     | 240      | 2126S      | 42     |
| 15052-1    | 132    | 1642-12    | 13        | 1C3130-001     | 240      | 2300       | 28     |
| 15052-25   | 132    | 1643-12    | 13        | 1C4030-001     | 240      | 2304F-30TZ | 28     |
| 15052-6    | 132    | 1644-12    | 13        | 1C4130-001     | 240      | 2306F-30TZ | 28     |
| 15053-2    | 134    | 1645-12    | 6         | 1R2004A20A120  | 222      | 2316       | 28     |
| 15053-25   | 134    | 1646-12    | 10        | 1R2006A20A120  | 222      | 2316F-30TZ | 28     |
| 15053-50   | 134    | 1647-12    | 41        | 1R3000A20A120  | 224      | 2320       | 28     |
| 15053W-2   | 134    | 1648-12    | 12        | 1R3000A20A120G | 242      | 2320F-20TZ | 28     |
| 15053W-25  | 134    | 1649-12    | 10        | 1R3000A28A120G | 242      | 2326F-30TZ | 28     |
| 15053W-50  | 134    | 1652-12    | 6, 10, 12 | 1R3000A28A120G | 242      | 2370       | 28     |
| 15054      | 134    | 1653-12    | 41        | 1R3004A20A120  | 222, 224 | 2404       | 46, 49 |
| 15054-1    | 134    | 1660       | 41        | 1R3006A20A120  | 224      | 2404MB     | 46, 50 |
| 1507       | 46, 65 | 1660S      | 41        | 1R3006A20A120G | 242      | 2404_142   | 51     |
| 1507MB     | 46, 66 | 1668       | 41        | 1R3006A20A120  | 222      | 2404_162   | 51     |
| 1533       | 46, 73 | 1675-12    | 41        | 1R3006A28A120G | 242      | 2407       | 46, 65 |
| 1533GCM    | 74     | 1676       | 41        | 1R4000A20A120  | 224      | 2407MB     | 46, 66 |
| 1533MB     | 46, 77 | 1676-EX    | 6         | 1R4000A20A120G | 242      | 2407_143   | 67     |
| 1534       | 46, 61 | 1677       | 41        | 1R4000A28A120G | 242      | 2407_163   | 67     |
| 1534MB     | 46, 62 | 1678-12    | 6         | 1R4004A20A120  | 222, 224 | 2434       | 46, 61 |
| 1547       | 46, 53 | 1682       | 41        | 1R4006A20A120  | 222, 224 | 2434MB     | 46, 62 |
| 1547GCM    | 54     | 1682S      | 41        | 1r4006A20A120G | 242      | 2434_143   | 63     |
| 1547MB     | 46, 57 | 1684       | 41        | 1R4006A28A120G | 242      | 2434_163   | 63     |
| 1548       | 46, 85 | 1684S      | 41        | 1R5000A20A120  | 224      | 2447       | 46, 53 |
| 1548MB     | 46, 86 | 1691-12    | 41        | 1R5004A20A120  | 222, 224 | 2447-W     | 59     |
| 1549       | 46, 61 | 1691-12B   | 41        | 1R5006A20A120  | 222, 224 | 2447-W-IN  | 59     |
| 1549MB     | 46, 62 | 1691-12BS  | 41        | 1R6004A20A130  | 222      | 2447-Y     | 59     |
| 15L47      | 54     | 1692-12B   | 41        | 1R6006A20A130  | 222      | 2447-Y-IN  | 59     |
| 15L47BLK   | 54     | 1692-12BS  | 41        | 200            | 31       | 2447EZ     | 54     |
| 15W04      | 46, 48 | 1701       | 122       | 2000           | 27       | 2447MB     | 46, 57 |
| 15W04MB    | 46, 50 | 1702       | 122       | 2000PLX25      | 26       | 2447_143   | 58     |
| 15W07      | 46, 64 | 1704       | 122       | 2000PLX50      | 26       | 2447_163   | 58     |
| 15W07MB    | 46, 66 | 1705       | 122       | 2001           | 27       | 2449       | 46, 61 |
| 15W33      | 46, 72 | 1706       | 122       | 2001-E         | 27       | 2449MB     | 46, 62 |
| 15W33GCM   | 74     | 1708       | 122       | 2002           | 27       | 2449_143   | 63     |
| 15W33MB    | 46, 76 | 1712       | 122       | 2003           | 27       | 2449_163   | 63     |
| 15W34      | 46, 60 | 1719       | 122       | 20051-1        | 132      | 24T04      | 46, 49 |
| 15W34MB    | 46, 62 | 1725       | 122       | 20051-25       | 132      | 24T49      | 46, 61 |
| 15W47      | 46, 52 | 1730       | 122       | 20051-6        | 132      | 24W04      | 46, 48 |
| 15W47GCM   | 54     | 1732       | 122       | 20052-1        | 132      | 24W04_142  | 51     |
| 15W47MB    | 46, 56 | 1733       | 122       | 20052-25       | 132      | 24W04_162  | 51     |
| 15W48      | 46, 84 | 1740       | 122       | 20052-6        | 132      | 24W07      | 46, 64 |
| 15W48MB    | 46, 86 | 1741       | 122       | 20053-2        | 132      | 24W07_143  | 67     |
| 15W49      | 46, 60 | 1744       | 122       | 20053W-2       | 132      | 24W07_163  | 67     |
| 15W49MB    | 46, 62 | 1783       | 122       | 20054          | 132      | 24W34      | 46, 60 |
| 1600-12A   | 12     | 179        | 21        | 20054-1        | 132      | 24W34_143  | 63     |
| 1600-12B   | 12     | 1793       | 122       | 20054-25       | 132      | 24W34_163  | 63     |
| 1601-12A   | 12     | 1794       | 122       | 20054-6        | 132      | 24W47      | 46, 52 |
| 1601-12B   | 12     | 1913SA     | 19        | 20055-1        | 132      | 24W47-Y    | 59     |
| 1606       | 41     | 1913SB     | 19        | 20055-25       | 132      | 24W47-Y-IN | 59     |

## ALPHANUMERIC LISTING OF PART NUMBERS

| PART NO.  | PAGE   | PART NO.   | PAGE   | PART NO.  | PAGE   | PART NO. | PAGE    |
|-----------|--------|------------|--------|-----------|--------|----------|---------|
| 24W47EZ   | 54     | 2675       | 46, 89 | 26W81_125 | 95     | 27W08MB  | 46, 82  |
| 24W47_143 | 58     | 2675MB     | 46, 90 | 26W82     | 46, 92 | 27W09    | 46, 80  |
| 24W47_163 | 58     | 2675_124   | 91     | 26W82_125 | 95     | 27W09MB  | 46, 82  |
| 24W49     | 46, 60 | 2675_144   | 91     | 26W83     | 46, 92 | 27W10    | 46, 80  |
| 24W49_143 | 63     | 2676       | 46, 89 | 26W83_125 | 95     | 27W10MB  | 46, 82  |
| 24W49_163 | 63     | 2676MB     | 46, 90 | 270-1     | 21     | 27W47    | 46, 72  |
| 2504      | 46, 49 | 2676_124   | 91     | 270-2     | 21     | 27W47MB  | 46, 76  |
| 2504MB    | 46, 50 | 2676_144   | 91     | 270-3     | 21     | 27W48    | 46, 84  |
| 2507      | 46, 65 | 2681       | 46, 93 | 2707      | 46, 69 | 27W48MB  | 46, 86  |
| 2507MB    | 46, 66 | 2681MB     | 46, 94 | 2707MB    | 46, 70 | 27W49    | 46, 84  |
| 2534      | 46, 61 | 2681_125   | 95     | 2708      | 46, 81 | 27W49MB  | 46, 86  |
| 2534MB    | 46, 62 | 2682       | 46, 93 | 2708G     | 46, 81 | 27W74    | 46, 88  |
| 2547      | 46, 53 | 2682MB     | 94     | 2708MB    | 46, 82 | 27W74MB  | 46, 90  |
| 2547GCM   | 54     | 2682_125   | 95     | 2709      | 46, 81 | 27W75    | 46, 88  |
| 2547MB    | 46, 57 | 2683       | 46, 93 | 2709MB    | 46, 82 | 27W75MB  | 46, 90  |
| 2549      | 46, 61 | 2683MB     | 46, 94 | 2710      | 46, 81 | 27W76    | 46, 88  |
| 2549MB    | 46, 62 | 2683_125   | 95     | 2710MB    | 46, 82 | 27W76MB  | 46, 90  |
| 25T04     | 46, 49 | 26T07      | 46, 69 | 271S      | 20     | 27W81    | 46, 92  |
| 25T49     | 46, 61 | 26T08      | 46, 81 | 271SA163  | 20     | 27W81MB  | 46, 94  |
| 25W04     | 46, 48 | 26T08G     | 46, 81 | 271SB163  | 20     | 27W82    | 46, 92  |
| 25W04MB   | 46, 50 | 26T09      | 46, 81 | 271U      | 20     | 27W82MB  | 46, 94  |
| 25W07     | 46, 64 | 26T10      | 46, 81 | 271UA163  | 20     | 27W83    | 46, 92  |
| 25W07MB   | 46, 66 | 26T47      | 46, 73 | 271UB163  | 20     | 27W83MB  | 46, 94  |
| 25W34     | 46, 60 | 26T48      | 46, 85 | 271US     | 20     | 2808     | 46, 101 |
| 25W34MB   | 46, 62 | 26T49      | 46, 85 | 271USA163 | 20     | 2808MB   | 46, 102 |
| 2607      | 46, 69 | 26T74      | 46, 89 | 271USB163 | 20     | 2808_103 | 103     |
| 2607MB    | 46, 70 | 26T75      | 46, 89 | 2747      | 46, 73 | 2808_123 | 103     |
| 2607_122  | 71     | 26T76      | 46, 89 | 2747MB    | 46, 77 | 2809     | 46, 101 |
| 2607_142  | 71     | 26T81      | 46, 93 | 2748      | 46, 85 | 2809MB   | 46, 102 |
| 2608      | 46, 81 | 26T82      | 93     | 2748MB    | 46, 86 | 2809_104 | 103     |
| 2608G     | 46, 81 | 26T83      | 46, 93 | 2749      | 46, 85 | 2809_124 | 103     |
| 2608MB    | 46, 82 | 26W07      | 46, 68 | 2749MB    | 46, 86 | 2847     | 46, 97  |
| 2608_123  | 83     | 26W07_122  | 71     | 2774      | 46, 89 | 2847MB   | 46, 98  |
| 2608_143  | 83     | 26W07_142  | 71     | 2774MB    | 46, 90 | 2847_103 | 99      |
| 2609      | 46, 81 | 26W08      | 46, 80 | 2775      | 46, 89 | 2847_123 | 99      |
| 2609MB    | 46, 82 | 26W08G     | 46, 80 | 2775MB    | 46, 90 | 2848     | 46, 97  |
| 2609_124  | 83     | 26W08_123  | 83     | 2776      | 46, 89 | 2848MB   | 46, 98  |
| 2609_144  | 83     | 26W08_143  | 83     | 2776MB    | 46, 90 | 2848_103 | 99      |
| 2610      | 46, 81 | 26W09      | 46, 80 | 2781      | 46, 93 | 2848_123 | 99      |
| 2610MB    | 46, 82 | 26W09_124  | 83     | 2781MB    | 46, 94 | 2849     | 46, 97  |
| 2647      | 46, 73 | 26W09_144  | 83     | 2782      | 46, 93 | 2849MB   | 46, 98  |
| 2647-W    | 79     | 26W10      | 46, 80 | 2782MB    | 94     | 2849_103 | 99      |
| 2647-W-IN | 79     | 26W47      | 46, 72 | 2783      | 46, 93 | 2849_123 | 99      |
| 2647-Y    | 79     | 26W47-W    | 79     | 2783MB    | 46, 94 | 2874     | 46, 105 |
| 2647-Y-IN | 79     | 26W47-W-IN | 79     | 279       | 21     | 2874MB   | 46, 106 |
| 2647MB    | 46, 77 | 26W47-Y    | 79     | 27T07     | 46, 69 | 2874_104 | 107     |
| 2647_123  | 78     | 26W47-Y-IN | 79     | 27T08     | 46, 81 | 2874_124 | 107     |
| 2647_143  | 78     | 26W47_123  | 78     | 27T08G    | 46, 81 | 2875     | 46, 105 |
| 2648      | 46, 85 | 26W47_143  | 78     | 27T09     | 46, 81 | 2875MB   | 46, 106 |
| 2648MB    | 46, 86 | 26W48      | 46, 84 | 27T10     | 46, 81 | 2875_104 | 107     |
| 2648_123  | 87     | 26W48_123  | 87     | 27T47     | 46, 73 | 2875_124 | 107     |
| 2648_143  | 87     | 26W48_143  | 87     | 27T48     | 46, 85 | 2876     | 46, 105 |
| 2649      | 46, 85 | 26W49      | 46, 84 | 27T49     | 46, 85 | 2876MB   | 46, 106 |
| 2649MB    | 46, 86 | 26W49_123  | 87     | 27T74     | 46, 89 | 2876_104 | 107     |
| 2649_123  | 87     | 26W49_143  | 87     | 27T75     | 46, 89 | 2876_124 | 107     |
| 2649_143  | 87     | 26W74      | 46, 88 | 27T76     | 46, 89 | 2877     | 46, 105 |
| 2674      | 46, 89 | 26W74_124  | 91     | 27T81     | 46, 93 | 2877MB   | 46, 106 |
| 2674MB    | 46, 90 | 26W74_144  | 91     | 27T82     | 93     | 2877_104 | 107     |
| 2674_124  | 91     | 26W75      | 46, 88 | 27T83     | 46, 93 | 2877_124 | 107     |
| 2674_144  | 91     | 26W75_124  | 91     | 27W07     | 46, 68 | 2881     | 46, 109 |
|           |        | 26W75_144  | 91     | 27W07MB   | 46, 70 | 2881MB   | 46, 110 |
|           |        | 26W76      | 46, 88 | 27W08     | 46, 80 | 2881_105 | 111     |
|           |        | 26W76_124  | 91     | 27W08G    | 46, 80 | 2881_125 | 111     |
|           |        | 26W76_144  | 91     | 27W08GMB  | 46     | 2882     | 46, 109 |
|           |        | 26W81      | 46, 92 | 27W08G0B  | 82     | 2882MB   | 46, 110 |



MOST WOODHEAD PRODUCTS HAVE U.L. AND/OR CSA APPROVALS.  
FOR A LISTING OF APPROVALS BY PART NUMBER, SEE PAGES 248-257.

# APPENDIX

## ALPHANUMERIC LISTING OF PART NUMBERS

| PART NO.  | PAGE    | PART NO.    | PAGE    | PART NO.    | PAGE | PART NO.    | PAGE     |
|-----------|---------|-------------|---------|-------------|------|-------------|----------|
| 2882_105  | 111     | 2974MB      | 46, 106 | 3000F-1     | 141  | 3081-7_122  | 140      |
| 2882_125  | 111     | 2975        | 46, 105 | 3001        | 140  | 3081F       | 141      |
| 2883      | 46, 109 | 2975MB      | 46, 106 | 3001-2      | 140  | 3082        | 140      |
| 2883MB    | 110     | 2976        | 46, 105 | 3001-2_143  | 140  | 3083        | 140      |
| 2883_105  | 111     | 2976MB      | 46, 106 | 3001F       | 141  | 3083-3      | 140      |
| 2883_125  | 111     | 2977        | 46, 105 | 3003        | 140  | 3083-3_123  | 140      |
| 28T08     | 46, 101 | 2977MB      | 46, 106 | 3003F       | 141  | 3083-9      | 140      |
| 28T09     | 46, 101 | 2981        | 46, 109 | 3005        | 140  | 3083-9_123  | 140      |
| 28T47     | 46, 97  | 2981MB      | 46, 110 | 3005-1      | 140  | 3083F       | 141      |
| 28T48     | 46, 97  | 2982        | 46, 109 | 3005-1_143  | 140  | 3085        | 140      |
| 28T49     | 46, 97  | 2982MB      | 46, 110 | 3005-2      | 140  | 3085-1      | 140      |
| 28T74     | 46, 105 | 2983        | 46, 109 | 3005-2_143  | 140  | 3085-10     | 140      |
| 28T75     | 46, 105 | 2983MB      | 110     | 3005-6      | 140  | 3085-10_123 | 140      |
| 28T76     | 46, 105 | 29T08       | 46, 101 | 3005-6_142  | 140  | 3085-2      | 140      |
| 28T77     | 46, 105 | 29T09       | 46, 101 | 3005-8      | 140  | 3085-6      | 140      |
| 28T81     | 46, 109 | 29T29       | 97      | 3005-8_143  | 140  | 3085-8      | 140      |
| 28T82     | 46, 109 | 29T47       | 46, 97  | 30051-1     | 132  | 3085F       | 141      |
| 28T83     | 46, 109 | 29T48       | 46, 97  | 30051-6     | 132  | 3086        | 140      |
| 28W08     | 46, 100 | 29T49       | 46      | 30052-1     | 132  | 3086-2      | 140      |
| 28W08_103 | 103     | 29T74       | 46, 105 | 30052-6     | 132  | 3086-7      | 140      |
| 28W08_123 | 103     | 29T75       | 46, 105 | 30053-1     | 132  | 3086-7_122  | 140      |
| 28W09     | 46, 100 | 29T76       | 46, 105 | 30053-25    | 132  | 3086F       | 141      |
| 28W09_104 | 103     | 29T77       | 46, 105 | 30053-6     | 132  | 3088-3      | 140      |
| 28W09_124 | 103     | 29T81       | 46, 109 | 30054-1     | 132  | 3088-3_123  | 140      |
| 28W47     | 46, 96  | 29T82       | 46, 109 | 30054-25    | 132  | 3088-9      | 140      |
| 28W47_103 | 99      | 29T83       | 46, 109 | 30054-6     | 132  | 3088-9_123  | 140      |
| 28W47_123 | 99      | 29W08       | 46, 100 | 3005F       | 141  | 3088F       | 141      |
| 28W48     | 46, 96  | 29W08MB     | 46, 102 | 3006        | 140  | 3090        | 142      |
| 28W48_103 | 99      | 29W09       | 46, 100 | 3006-2      | 140  | 3090F       | 142      |
| 28W48_123 | 99      | 29W09MB     | 46, 102 | 3006-2_143  | 140  | 3091        | 142      |
| 28W49     | 46, 96  | 29W47       | 46, 96  | 3006F       | 141  | 3091F       | 142      |
| 28W49_103 | 99      | 29W47MB     | 46, 98  | 3008        | 140  | 3095-000    | 146      |
| 28W49_123 | 99      | 29W48       | 46, 96  | 3008F       | 141  | 3095-001    | 146      |
| 28W74     | 46, 104 | 29W48MB     | 46, 98  | 300W        | 37   | 3095-002    | 146      |
| 28W74_104 | 107     | 29W49       | 46, 96  | 301         | 37   | 3095-003    | 146      |
| 28W74_124 | 107     | 29W49MB     | 46, 98  | 302SRL      | 39   | 3095-004    | 146      |
| 28W75     | 46, 104 | 29W74       | 46, 104 | 302SRLCA    | 39   | 3095-010    | 146      |
| 28W75_104 | 107     | 29W74MB     | 46, 106 | 302U        | 37   | 3095-011    | 146      |
| 28W75_124 | 107     | 29W75       | 46, 104 | 305         | 37   | 3095-012    | 146      |
| 28W76     | 46, 104 | 29W75MB     | 46, 106 | 3050        | 142  | 3095-013    | 146      |
| 28W76_104 | 107     | 29W76       | 46, 104 | 3050F       | 142  | 3095-014    | 146      |
| 28W76_124 | 107     | 29W76MB     | 46, 106 | 3059        | 142  | 3095-015    | 146      |
| 28W77     | 46, 104 | 29W77       | 46, 104 | 306         | 37   | 3095-016    | 146      |
| 28W77_104 | 107     | 29W77MB     | 46, 106 | 3065        | 143  | 3095-017    | 146      |
| 28W77_124 | 107     | 29W81       | 46, 108 | 3066        | 143  | 3099        | 142      |
| 28W81     | 46, 108 | 29W81MB     | 46, 110 | 3070-GFI    | 136  | 31-5800     | 211, 219 |
| 28W81_105 | 111     | 29W82       | 46, 108 | 3070F-GFI   | 133  | 310         | 37       |
| 28W81_125 | 111     | 29W82MB     | 46, 110 | 3070W-GFI   | 133  | 3100B4W     | 117      |
| 28W82     | 46, 108 | 29W83       | 46, 108 | 3070W-GFI20 | 133  | 3100B5W     | 117      |
| 28W82_105 | 111     | 29W83MB     | 46, 110 | 3080        | 140  | 3100B6W     | 117      |
| 28W82_125 | 111     | 30-0310     | 21      | 3080-1      | 140  | 3100B7W     | 117      |
| 28W83     | 46, 108 | 30-0321     | 217     | 3080-10     | 140  | 3100C4W     | 117      |
| 28W83_105 | 111     | 300         | 37      | 3080-10_123 | 140  | 3100C5W     | 117      |
| 28W83_125 | 111     | 3000        | 140     | 3080-2      | 140  | 3100C6W     | 117      |
| 2908      | 46, 101 | 3000-1      | 140     | 3080-6      | 140  | 3100C7W     | 117      |
| 2908MB    | 46, 102 | 3000-10     | 140     | 3080-8      | 140  | 3100M4W     | 117      |
| 2909      | 46, 101 | 3000-10_123 | 140     | 3080-GFI    | 136  | 3100M6W     | 117      |
| 2909MB    | 46, 102 | 3000-1_143  | 140     | 3080-GFI20  | 136  | 3100M7W     | 117      |
| 2947      | 46, 97  | 3000-2      | 140     | 3080F       | 141  | 3100P4W     | 117      |
| 2947MB    | 46, 98  | 3000-2_143  | 140     | 3080F-1     | 141  | 3100P5W     | 117      |
| 2948      | 46, 97  | 3000-6      | 140     | 3080F-GFI   | 133  | 3100P6W     | 117      |
| 2948MB    | 46, 98  | 3000-6_142  | 140     | 3080F-GFI20 | 133  | 3100P7W     | 117      |
| 2949      | 46, 97  | 3000-8      | 140     | 3081        | 140  | 3100R4W     | 117      |
| 2949MB    | 46, 98  | 3000-8_143  | 140     | 3081-2      | 140  | 3100R5W     | 117      |
| 2974      | 46, 105 | 3000F       | 141     | 3081-7      | 140  | 3100R6W     | 117      |



## ALPHANUMERIC LISTING OF PART NUMBERS

| PART NO.  | PAGE | PART NO.   | PAGE | PART NO.    | PAGE | PART NO.   | PAGE          |
|-----------|------|------------|------|-------------|------|------------|---------------|
| 3100R7W   | 117  | 320P7      | 118  | 3290-8B143  | 148  | 330P6      | 119           |
| 310123    | 36   | 320P7W     | 116  | 3290-8E143  | 148  | 330P6W     | 117           |
| 310143    | 36   | 320R4      | 118  | 3290-9      | 148  | 330P7      | 119           |
| 310223    | 36   | 320R4W     | 116  | 3290-9B123  | 148  | 330P7W     | 117           |
| 310243    | 36   | 320R5      | 118  | 3290-9E123  | 148  | 330R4      | 119           |
| 310323    | 36   | 320R5W     | 116  | 32G15_123   | 138  | 330R4W     | 117           |
| 310423    | 36   | 320R6      | 118  | 32G20_123   | 138  | 330R5      | 119           |
| 310W      | 37   | 320R6W     | 116  | 32GM15_123  | 138  | 330R5W     | 117           |
| 31550     | 150  | 320R7      | 118  | 32GM20_123  | 138  | 330R6      | 119           |
| 31550A122 | 150  | 320R7W     | 116  | 32HG15_123  | 138  | 330R6W     | 117           |
| 31550A142 | 150  | 3210       | 144  | 32HG20_123  | 138  | 330R7      | 119           |
| 31550B122 | 150  | 3215       | 144  | 32W07       | 144  | 330R7W     | 117           |
| 31550B142 | 150  | 321637     | 36   | 32W33       | 144  | 3320F_123  | 137           |
| 31552     | 150  | 3220       | 144  | 32W33A123   | 144  | 3320_123   | 137           |
| 31552A123 | 150  | 3225       | 144  | 32W47       | 144  | 3321F_123  | 137           |
| 31552A143 | 150  | 3230       | 144  | 32W47A123   | 144  | 3321_123   | 137           |
| 31552B123 | 150  | 323123     | 36   | 32W90-1     | 148  | 3322F_123  | 137           |
| 31552B143 | 150  | 323124     | 36   | 32W90-1B143 | 148  | 3322_123   | 137           |
| 31565     | 150  | 323125     | 36   | 32W90-1E143 | 148  | 3323F_123  | 137           |
| 31565A123 | 150  | 323126     | 36   | 32W90-2     | 148  | 3323_123   | 137           |
| 31565A143 | 150  | 323133     | 36   | 32W90-2B143 | 148  | 3324F_123  | 137           |
| 31565B123 | 150  | 323134     | 36   | 32W90-2E143 | 148  | 3324_123   | 137           |
| 31565B143 | 150  | 323135     | 36   | 32W90-8     | 148  | 3325F_123  | 137           |
| 31593     | 150  | 3235       | 144  | 32W90-8B143 | 148  | 3325_123   | 137           |
| 31593A123 | 150  | 323523     | 36   | 32W90-8E143 | 148  | 3326F_123  | 137           |
| 31593A143 | 150  | 323524     | 36   | 32WG15_123  | 138  | 3326_123   | 137           |
| 31593B123 | 150  | 323525     | 36   | 32WG20_123  | 138  | 3327F_123  | 137           |
| 31593B143 | 150  | 323526     | 36   | 3301GF      | 136  | 3327_123   | 137           |
| 31594     | 150  | 323533     | 36   | 3301GF_143  | 136  | 3330F_123  | 146           |
| 31594A123 | 150  | 323534     | 36   | 3301GGF_143 | 136  | 3330RF_123 | 146           |
| 31594A143 | 150  | 323535     | 36   | 3302GF      | 136  | 3330R_123  | 146           |
| 31594B123 | 150  | 3240       | 144  | 3302GF_143  | 136  | 3330_123   | 146           |
| 31594B143 | 150  | 3245       | 144  | 3302GGF_143 | 136  | 3331F_123  | 146           |
| 3200      | 144  | 3250       | 144  | 3304GF      | 136  | 3331RF_123 | 146           |
| 320122    | 36   | 32547      | 150  | 3304GF_123  | 136  | 3331R_123  | 146           |
| 320522    | 36   | 32547A123  | 150  | 3304GGF_123 | 136  | 3331_123   | 146           |
| 320BA4    | 118  | 32547A143  | 150  | 330BA12     | 119  | 3332F_123  | 146           |
| 320BA4W   | 116  | 32547B123  | 150  | 330BA12W    | 117  | 3332RF_123 | 146           |
| 320BA5    | 118  | 32547B143  | 150  | 330BA4      | 119  | 3332R_123  | 146           |
| 320BA5W   | 116  | 3255       | 144  | 330BA4W     | 117  | 3332_123   | 146           |
| 320BA6    | 118  | 32553      | 150  | 330BA5      | 119  | 3333F_123  | 146           |
| 320BA6W   | 116  | 32553A123  | 150  | 330BA5W     | 117  | 3333RF_123 | 146           |
| 320BA7    | 118  | 32553A143  | 150  | 330BA6      | 119  | 3333R_123  | 146           |
| 320BA7W   | 116  | 32553B123  | 150  | 330BA6W     | 117  | 3333_123   | 146           |
| 320C4     | 118  | 32553B143  | 150  | 330BA7      | 119  | 3362GF     | 143           |
| 320C4W    | 116  | 32708      | 150  | 330BA7W     | 117  | 34-0040    | 31            |
| 320C5     | 118  | 32708A123  | 150  | 330C4       | 119  | 34-0120    | 16, 19        |
| 320C5W    | 116  | 32708A143  | 150  | 330C4W      | 117  | 34-0120    | 26-27, 32-33, |
| 320C6     | 118  | 32708B123  | 150  | 330C5       | 119  |            | 42            |
| 320C6W    | 116  | 32708B143  | 150  | 330C5W      | 117  | 34-0130    | 16            |
| 320C7     | 118  | 32747      | 150  | 330C6       | 119  | 34-0130    | 42            |
| 320C7W    | 116  | 32747A123  | 150  | 330C6W      | 117  | 34-0137    | 17            |
| 320MI4    | 118  | 32747A143  | 150  | 330C7       | 119  | 34-0190    | 31            |
| 320MI4W   | 116  | 32747B123  | 150  | 330C7W      | 117  | 34-0210    | 41            |
| 320MI5    | 118  | 32747B143  | 150  | 330MI4      | 119  | 34-0230    | 31            |
| 320MI6    | 118  | 3290-1     | 148  | 330MI4W     | 117  | 34-0380    | 41            |
| 320MI6W   | 116  | 3290-1B143 | 148  | 330MI5      | 119  | 34-0390    | 16, 19, 25    |
| 320MI7    | 118  | 3290-1E143 | 148  | 330MI6      | 119  | 34-0390    | 42            |
| 320MI7W   | 116  | 3290-2     | 148  | 330MI6W     | 117  | 34-0391    | 7, 19, 23     |
| 320P4     | 118  | 3290-2B143 | 148  | 330MI7      | 119  | 34-0391    | 35, 42        |
| 320P4W    | 116  | 3290-2E143 | 148  | 330MI7W     | 117  | 34-1910    | 18            |
| 320P5     | 118  | 3290-3     | 148  | 330P4       | 119  | 34-1910    | 32            |
| 320P5W    | 116  | 3290-3B123 | 148  | 330P4W      | 117  | 34-2120    | 41            |
| 320P6     | 118  | 3290-3E123 | 148  | 330P5       | 119  | 34-2310    | 18            |
| 320P6W    | 116  | 3290-8     | 148  | 330P5W      | 117  | 34-2840    | 41            |



MOST WOODHEAD PRODUCTS HAVE U.L. AND/OR CSA APPROVALS.  
FOR A LISTING OF APPROVALS BY PART NUMBER, SEE PAGES 248-257.

## ALPHANUMERIC LISTING OF PART NUMBERS

| PART NO.  | PAGE | PART NO. | PAGE | PART NO. | PAGE | PART NO. | PAGE |
|-----------|------|----------|------|----------|------|----------|------|
| 35898     | 178  | 36-0670  | 217  | 36117    | 182  | 36289    | 155  |
| 35899     | 178  | 36-0690  | 217  | 36118    | 182  | 36290    | 155  |
| 35901     | 175  | 36-2001  | 27   | 36120    | 183  | 36292    | 155  |
| 35902     | 175  | 36-2002  | 27   | 36121    | 183  | 36294    | 155  |
| 35903     | 175  | 36-2004  | 27   | 36122    | 183  | 36296    | 155  |
| 35904     | 175  | 36-2005  | 26   | 36123    | 183  | 36298    | 155  |
| 35905     | 175  | 36-2006  | 26   | 36124    | 183  | 362V     | 40   |
| 35906     | 175  | 36-2080  | 19   | 36125    | 183  | 36300    | 15   |
| 35907     | 175  | 36-2081  | 19   | 36126    | 183  | 36302    | 155  |
| 35908     | 175  | 36-2083  | 42   | 36127    | 183  | 36310    | 154  |
| 35909     | 175  | 36010    | 178  | 36128    | 183  | 36312    | 154  |
| 35910     | 175  | 360BA4   | 119  | 36130    | 183  | 36314    | 154  |
| 35911     | 175  | 360BA4W  | 117  | 36131    | 183  | 36316    | 154  |
| 35912     | 175  | 360BA5   | 119  | 36132    | 183  | 36317    | 155  |
| 35913     | 175  | 360BA5W  | 117  | 36133    | 183  | 36319    | 155  |
| 35914     | 175  | 360BA6   | 119  | 36134    | 183  | 36321    | 155  |
| 35915     | 175  | 360BA6W  | 117  | 36135    | 183  | 36323    | 155  |
| 35916     | 175  | 360BA7   | 119  | 36136    | 183  | 36326    | 155  |
| 35917     | 175  | 360BA7W  | 117  | 36137    | 183  | 36328    | 155  |
| 35918     | 175  | 360C4    | 119  | 36140    | 183  | 36330    | 155  |
| 35919     | 175  | 360C4W   | 117  | 36141    | 183  | 36340    | 154  |
| 35930     | 176  | 360C5    | 119  | 36142    | 183  | 36342    | 154  |
| 35931     | 176  | 360C5W   | 117  | 36143    | 183  | 36344    | 154  |
| 35932     | 176  | 360C6    | 119  | 36144    | 183  | 36346    | 154  |
| 35933     | 176  | 360C6W   | 117  | 36145    | 183  | 36347    | 155  |
| 35934     | 176  | 360C7    | 119  | 36146    | 183  | 36349    | 155  |
| 35935     | 176  | 360C7W   | 117  | 36147    | 183  | 36351    | 155  |
| 35936     | 176  | 360M15   | 119  | 36148    | 183  | 36353    | 155  |
| 35940     | 177  | 360M14   | 119  | 36149    | 183  | 36355    | 155  |
| 35941     | 177  | 360M14W  | 117  | 36150    | 183  | 36357    | 155  |
| 35942     | 177  | 360M16   | 119  | 362      | 40   | 36359    | 155  |
| 35943     | 177  | 360M16W  | 117  | 36237    | 172  | 36361    | 155  |
| 35944     | 177  | 360M17   | 119  | 36238    | 172  | 36362    | 155  |
| 35945     | 177  | 360M17W  | 117  | 36241    | 172  | 36363    | 155  |
| 35946     | 177  | 360P4    | 119  | 36245    | 154  | 36364    | 155  |
| 35947     | 177  | 360P4W   | 117  | 36246    | 154  | 36370    | 162  |
| 35948     | 177  | 360P5    | 119  | 36248    | 155  | 36371    | 162  |
| 35950     | 177  | 360P5W   | 117  | 36249    | 155  | 36372    | 162  |
| 35951     | 177  | 360P6    | 119  | 36250    | 154  | 36373    | 162  |
| 35952     | 177  | 360P6W   | 117  | 36251    | 154  | 36374    | 162  |
| 35953     | 177  | 360P7    | 119  | 36254    | 154  | 36375    | 162  |
| 35954     | 177  | 360P7W   | 117  | 36256    | 154  | 36380    | 162  |
| 35955     | 177  | 360R4    | 119  | 36257    | 155  | 36381    | 162  |
| 35956     | 177  | 360R4W   | 117  | 36259    | 155  | 36382    | 162  |
| 35960     | 177  | 360R5    | 119  | 36261    | 155  | 36390    | 162  |
| 35961     | 177  | 360R5W   | 117  | 36263    | 155  | 36391    | 162  |
| 35962     | 177  | 360R6    | 119  | 36265    | 155  | 36392    | 162  |
| 35963     | 177  | 360R6W   | 117  | 36267    | 155  | 36393    | 162  |
| 35964     | 177  | 360R7    | 119  | 36269    | 155  | 36394    | 162  |
| 35965     | 177  | 360R7W   | 117  | 36270    | 155  | 36395    | 162  |
| 35966     | 177  | 36101    | 182  | 36271    | 155  | 364      | 40   |
| 35970     | 174  | 36102    | 182  | 36272    | 155  | 36400    | 162  |
| 35971     | 174  | 36103    | 182  | 36273    | 155  | 36401    | 162  |
| 35972     | 174  | 36104    | 182  | 36274    | 155  | 36402    | 162  |
| 35973     | 174  | 36105    | 182  | 36275    | 155  | 36403    | 162  |
| 35974     | 174  | 36106    | 182  | 36276    | 155  | 36404    | 162  |
| 35975     | 174  | 36107    | 182  | 36277    | 155  | 36405    | 162  |
| 35976     | 174  | 36108    | 182  | 36278    | 155  | 36430    | 154  |
| 35980     | 177  | 36109    | 182  | 36279    | 155  | 36431    | 154  |
| 35990     | 175  | 36111    | 182  | 36280    | 154  | 36432    | 154  |
| 35W07     | 144  | 36112    | 182  | 36282    | 154  | 36436    | 154  |
| 35W34     | 144  | 36113    | 182  | 36284    | 154  | 36437    | 154  |
| 35W47     | 144  | 36114    | 182  | 36286    | 154  | 36438    | 154  |
| 35W47A123 | 144  | 36115    | 182  | 36287    | 155  | 36440    | 162  |
| 36-0660   | 217  | 36116    | 182  | 36288    | 155  | 36442    | 162  |



MOST WOODHEAD PRODUCTS HAVE U.L. AND/OR CSA APPROVALS.  
FOR A LISTING OF APPROVALS BY PART NUMBER, SEE PAGES 248-257.

# APPENDIX

## ALPHANUMERIC LISTING OF PART NUMBERS

| PART NO. | PAGE | PART NO. | PAGE | PART NO. | PAGE | PART NO. | PAGE     |
|----------|------|----------|------|----------|------|----------|----------|
| 36443    | 162  | 36582    | 172  | 36696    | 173  | 37105-90 | 163      |
| 36469    | 155  | 36583    | 171  | 367      | 40   | 37106    | 163      |
| 36470    | 155  | 36584    | 172  | 367V     | 40   | 37106-90 | 163      |
| 36471    | 155  | 36585    | 171  | 368      | 40   | 372      | 37       |
| 36472    | 155  | 36586    | 171  | 36800    | 155  | 372V     | 37       |
| 36473    | 155  | 36587    | 172  | 36801    | 155  | 3762N    | 46, 112  |
| 36475    | 155  | 36588    | 171  | 36802    | 155  | 3763N    | 46, 112  |
| 36476    | 155  | 36589    | 172  | 36803    | 155  | 3764N    | 46, 114  |
| 36477    | 155  | 36590    | 171  | 36804    | 155  | 3765N    | 46, 114  |
| 36478    | 155  | 36591    | 172  | 36805    | 155  | 3769     | 46, 115  |
| 36479    | 155  | 36594    | 172  | 36806    | 155  | 377      | 3        |
| 36480    | 155  | 36610    | 180  | 36807    | 155  | 3771     | 46, 113  |
| 36481    | 155  | 36611    | 180  | 36808    | 155  | 3775     | 46, 115  |
| 36482    | 155  | 36612    | 180  | 36809    | 155  | 3777     | 46, 113  |
| 36483    | 155  | 36613    | 180  | 36810    | 155  | 37V      | 3        |
| 36484    | 155  | 36614    | 180  | 36811    | 155  | 378      | 37       |
| 36485    | 155  | 36615    | 180  | 36812    | 155  | 378V     | 37       |
| 36486    | 155  | 36620    | 179  | 36813    | 155  | 37W62    | 46, 112  |
| 36487    | 155  | 36621    | 179  | 36814    | 155  | 37W63    | 46, 112  |
| 36488    | 155  | 36622    | 179  | 36815    | 155  | 37W64    | 46, 114  |
| 36489    | 155  | 36623    | 179  | 36816    | 155  | 37W65    | 46, 114  |
| 36490    | 154  | 36624    | 179  | 36818    | 155  | 380010A  | 35       |
| 36496    | 154  | 36625    | 179  | 36819    | 155  | 380310A  | 35       |
| 36497    | 155  | 36626    | 179  | 36826    | 155  | 380510A  | 35       |
| 36498    | 155  | 36627    | 179  | 36827    | 155  | 380R     | 40       |
| 36499    | 155  | 36628    | 179  | 36829    | 155  | 381R     | 37       |
| 364V     | 40   | 36629    | 179  | 36830    | 155  | 382      | 40       |
| 36500    | 155  | 36630    | 179  | 36831    | 155  | 383      | 37       |
| 36501    | 161  | 36640    | 179  | 36834    | 155  | 385      | 37       |
| 36502    | 161  | 36641    | 179  | 36835    | 155  | 387010A  | 35       |
| 36503    | 161  | 36642    | 179  | 368V     | 40   | 387510A  | 35       |
| 36504    | 161  | 36643    | 179  | 37-0360  | 209  | 393E123  | 43       |
| 36505    | 161  | 36644    | 179  | 37-0361  | 209  | 393E143  | 43       |
| 36506    | 161  | 36645    | 179  | 37-0362  | 209  | 40-0560  | 121      |
| 36508    | 161  | 36646    | 179  | 37-0363  | 209  | 40-1020  | 16       |
| 36509    | 161  | 36647    | 179  | 37-0364  | 209  | 40-1021  | 16       |
| 36512    | 161  | 36648    | 179  | 37-0365  | 209  | 40-1040  | 16       |
| 36513    | 161  | 36649    | 179  | 37-0366  | 209  | 40-1040B | 17       |
| 36514    | 161  | 36650    | 179  | 37-0367  | 209  | 40-1043  | 42       |
| 36515    | 161  | 36660    | 181  | 37-0368  | 209  | 40-1120  | 18       |
| 36516    | 161  | 36661    | 181  | 37-0901  | 20   | 40-1140  | 18       |
| 36517    | 161  | 36662    | 181  | 37-1200  | 17   | 40-1485  | 33       |
| 36518    | 161  | 36663    | 181  | 37-7400  | 17   | 40-9441  | 7        |
| 36519    | 161  | 36664    | 181  | 37-7410  | 17   | 40-9442  | 7        |
| 36550    | 161  | 36665    | 181  | 370      | 37   | 40-9451  | 7        |
| 36551    | 161  | 36670    | 173  | 37030    | 162  | 40-9456  | 7        |
| 36552    | 161  | 36671    | 173  | 37031    | 162  | 4002     | 213      |
| 36553    | 161  | 36672    | 173  | 37032    | 162  | 4003     | 213      |
| 36554    | 161  | 36673    | 173  | 37033    | 162  | 4004     | 213      |
| 36555    | 161  | 36674    | 173  | 37034    | 162  | 4005     | 213      |
| 36560    | 172  | 36675    | 173  | 37035    | 162  | 4006     | 213      |
| 36562    | 172  | 36676    | 173  | 37036    | 162  | 4007     | 213      |
| 36564    | 172  | 36680    | 173  | 37037    | 162  | 4008     | 213      |
| 36567    | 172  | 36681    | 173  | 37038    | 162  | 4009     | 213      |
| 36569    | 172  | 36682    | 173  | 37100    | 163  | 4010     | 213      |
| 36571    | 172  | 36683    | 173  | 37100-90 | 163  | 4011     | 213      |
| 36573    | 171  | 36684    | 173  | 37101    | 163  | 4012     | 213      |
| 36574    | 172  | 36685    | 173  | 37101-90 | 163  | 402      | 43       |
| 36575    | 171  | 36686    | 173  | 37102    | 163  | 4020     | 209, 212 |
| 36576    | 171  | 36690    | 173  | 37102-90 | 163  | 4020-2   | 209, 212 |
| 36577    | 171  | 36691    | 173  | 37103    | 163  | 4022     | 208      |
| 36578    | 171  | 36692    | 173  | 37103-90 | 163  | 4022-2   | 208      |
| 36579    | 171  | 36693    | 173  | 37104    | 163  | 4022ES   | 208      |
| 36580    | 172  | 36694    | 173  | 37104-90 | 163  | 4022G    | 209      |
| 36581    | 171  | 36695    | 173  | 37105    | 163  | 4023     | 208      |

## ALPHANUMERIC LISTING OF PART NUMBERS

| PART NO.      | PAGE | PART NO. | PAGE     | PART NO.      | PAGE | PART NO.      | PAGE     |
|---------------|------|----------|----------|---------------|------|---------------|----------|
| 4023-2        | 208  | 41037    | 226      | 420R9         | 118  | 460BA5W       | 117      |
| 4023ES        | 208  | 41048    | 226      | 420R9W        | 116  | 460BA7        | 119      |
| 4023G         | 209  | 41132    | 226      | 4212          | 213  | 460BA7W       | 117      |
| 4024          | 208  | 41212    | 226      | 43-4371       | 21   | 460BA9        | 119      |
| 4024-2        | 208  | 41344    | 226      | 43-4381       | 21   | 460BA9W       | 117      |
| 4024ES        | 208  | 41481    | 226      | 43-4391       | 21   | 460C12        | 119      |
| 4024G         | 209  | 41593    | 226      | 430BA5        | 119  | 460C12W       | 117      |
| 4026          | 208  | 42-1060  | 33       | 430BA5W       | 117  | 460C5         | 119      |
| 4026-2        | 208  | 42-1062  | 27       | 430BA7        | 119  | 460C5W        | 117      |
| 4026ES        | 208  | 42-2040  | 209, 213 | 430BA7W       | 117  | 460C7         | 119      |
| 4026G         | 209  | 42-2060  | 209, 213 | 430BA9        | 119  | 460C7W        | 117      |
| 4028          | 208  | 42-2080  | 209, 213 | 430BA9W       | 117  | 460C9         | 119      |
| 4028-2        | 208  | 42-2090  | 209, 213 | 430C12        | 119  | 460C9W        | 117      |
| 4028ES        | 208  | 42-2110  | 209, 213 | 430C12W       | 117  | 460M12        | 119      |
| 4028G         | 209  | 42-2130  | 209, 213 | 430C5         | 119  | 460M12W       | 117      |
| 403000A10M020 | 236  | 42-2190  | 211      | 430C5W        | 117  | 460M15        | 119      |
| 403001A10M020 | 236  | 42-4370  | 21       | 430C7         | 119  | 460M15W       | 117      |
| 403006A10M020 | 236  | 42-4380  | 21       | 430C7W        | 117  | 460M17        | 119      |
| 403007A10M020 | 236  | 42-4390  | 21       | 430C9         | 119  | 460M17W       | 117      |
| 4032          | 212  | 4202     | 213      | 430C9W        | 117  | 460M19        | 119      |
| 4032-2        | 212  | 4203     | 213      | 430M12        | 119  | 460M19W       | 117      |
| 404000A10M020 | 236  | 4204     | 213      | 430M12W       | 117  | 460P12        | 119      |
| 404001A10M020 | 236  | 4205     | 213      | 430M15        | 119  | 460P12W       | 119      |
| 404006A10M020 | 236  | 4206     | 213      | 430M15W       | 117  | 460P5         | 119      |
| 404007A10M020 | 236  | 4207     | 213      | 430M17        | 119  | 460P5W        | 117      |
| 405           | 43   | 4208     | 213      | 430M17W       | 117  | 460P7         | 119      |
| 405000A10M020 | 236  | 4209     | 213      | 430M19        | 119  | 460P7W        | 117      |
| 405001A10M020 | 236  | 420BA12  | 118      | 430M19W       | 117  | 460P9         | 119      |
| 405006A10M020 | 236  | 420BA12W | 116      | 430P12        | 119  | 460P9W        | 117      |
| 405007A10M020 | 236  | 420BA5   | 118      | 430P12W       | 117  | 460R12        | 119      |
| 4052          | 211  | 420BA5W  | 116      | 430P5         | 119  | 460R12W       | 117      |
| 4052PC        | 211  | 420BA7   | 118      | 430P5W        | 117  | 460R5         | 119      |
| 40718         | 226  | 420BA7W  | 116      | 430P7         | 119  | 460R5W        | 117      |
| 40761         | 226  | 420BA9   | 118      | 430P7W        | 117  | 460R7         | 119      |
| 40780         | 226  | 420BA9W  | 116      | 430P9         | 119  | 460R7W        | 117      |
| 40925         | 226  | 420C12   | 118      | 430P9W        | 117  | 460R9         | 119      |
| 41-6762       | 11   | 420C12W  | 116      | 430R12        | 119  | 460R9W        | 119      |
| 41-7370       | 15   | 420C5    | 118      | 430R12W       | 117  | 4700DW        | 57       |
| 41-7380       | 15   | 420C5W   | 116      | 430R5         | 119  | 4720          | 46, 53   |
| 41-7390       | 15   | 420C7    | 118      | 430R5W        | 117  | 4729          | 46, 53   |
| 41-7400       | 15   | 420C7W   | 116      | 430R7         | 119  | 4730          | 46, 65   |
| 41-7410       | 15   | 420C9    | 118      | 430R7W        | 117  | 4739          | 46, 65   |
| 41-7420       | 15   | 420C9W   | 116      | 430R9         | 119  | 4747          | 77       |
| 41-7430       | 15   | 420M12   | 118      | 430R9W        | 117  | 4748          | 86       |
| 41-7440       | 15   | 420M12W  | 116      | 440           | 151  | 4749          | 86       |
| 4100B12W      | 117  | 420M15   | 118      | 440F          | 151  | 4770          | 46, 61   |
| 4100B5W       | 117  | 420M15W  | 116      | 442           | 151  | 4774          | 90       |
| 4100B7W       | 117  | 420M17   | 118      | 443030A10M020 | 236  | 4775          | 90       |
| 4100B9W       | 117  | 420M17W  | 116      | 443031A10M020 | 236  | 4776          | 90       |
| 4100C12W      | 117  | 420M19   | 118      | 443032A10M020 | 236  | 4779          | 46, 61   |
| 4100C5W       | 117  | 420M19W  | 116      | 443033A10M020 | 236  | 4947          | 98       |
| 4100C7W       | 117  | 420P12   | 118      | 444030A10M020 | 236  | 4948          | 98       |
| 4100C9W       | 117  | 420P12W  | 116      | 444031A10M020 | 236  | 4949          | 98       |
| 4100M12W      | 117  | 420P5    | 118      | 444032A10M020 | 236  | 4974          | 106      |
| 4100M15W      | 117  | 420P5W   | 116      | 444033A10M020 | 236  | 4975          | 106      |
| 4100M17W      | 117  | 420P7    | 118      | 445           | 151  | 4976          | 106      |
| 4100M19W      | 117  | 420P7W   | 116      | 445030A10M020 | 236  | 4R3P00A27C300 | 236, 238 |
| 4100P12W      | 117  | 420P9    | 118      | 445031A10M020 | 236  | 4R3P06A27C300 | 236, 238 |
| 4100P5W       | 117  | 420P9W   | 116      | 445032A10M020 | 236  | 4R4P00A27C300 | 236, 238 |
| 4100P7W       | 117  | 420R12   | 118      | 445033A10M020 | 236  | 4R4P06A27C300 | 236, 238 |
| 4100P9W       | 117  | 420R12W  | 116      | 446           | 151  | 4R5P00A27C300 | 236      |
| 4100R12W      | 117  | 420R5    | 118      | 446F          | 151  | 4R5P06A27C300 | 236      |
| 4100R5W       | 117  | 420R5W   | 116      | 460BA12       | 119  | 50-0110       | 121      |
| 4100R7W       | 117  | 420R7    | 118      | 460BA12W      | 117  | 5000          | 38       |
| 4100R9W       | 117  | 420R7W   | 116      | 460BA5        | 119  | 5001          | 38       |



MOST WOODHEAD PRODUCTS HAVE U.L. AND/OR CSA APPROVALS.  
FOR A LISTING OF APPROVALS BY PART NUMBER, SEE PAGES 248-257.

# APPENDIX

## ALPHANUMERIC LISTING OF PART NUMBERS

| PART NO.    | PAGE     | PART NO. | PAGE   | PART NO. | PAGE   | PART NO. | PAGE |
|-------------|----------|----------|--------|----------|--------|----------|------|
| 5002        | 38       | 520C7W   | 116    | 5369     | 46, 73 | 5530NM   | 157  |
| 5003        | 38       | 520C9    | 118    | 5369-RB  | 73     | 5530W    | 157  |
| 5006        | 38       | 520C9W   | 116    | 5369L    | 75     | 5531     | 159  |
| 5007        | 38       | 520MI5   | 118    | 5398     | 156    | 5531M    | 159  |
| 5008        | 38       | 520MI5W  | 116    | 5400     | 156    | 5531NM   | 159  |
| 5009        | 38       | 520MI7   | 118    | 5402     | 156    | 5531W    | 159  |
| 505B-RM     | 210      | 520MI7W  | 116    | 5452DW   | 86     | 5532     | 157  |
| 505BC-C     | 210      | 520MI9   | 118    | 5462DW   | 86     | 5532M    | 157  |
| 505BC-L     | 210, 219 | 520MI9W  | 116    | 5466     | 46, 85 | 5532W    | 157  |
| 505BC-LNS   | 210      | 520P5    | 118    | 5469     | 46, 85 | 5533     | 159  |
| 505E-10     | 210      | 520P5W   | 116    | 5498     | 156    | 5533M    | 159  |
| 505E-12     | 210      | 520P7    | 118    | 5499     | 158    | 5533W    | 159  |
| 505E-2      | 210      | 520P7W   | 116    | 55-0426  | 226    | 5534     | 157  |
| 505E-4      | 210      | 520P9    | 118    | 5500     | 156    | 5534M    | 157  |
| 505E-6      | 210      | 520P9W   | 116    | 5501     | 158    | 5534W    | 157  |
| 505E-8      | 210      | 520R5    | 118    | 5502     | 156    | 5535     | 159  |
| 505E-TL     | 210      | 520R5W   | 116    | 5503     | 158    | 5535M    | 159  |
| 505E-TS     | 210      | 520R7    | 118    | 5504     | 156    | 5535W    | 159  |
| 505M-TAG    | 210      | 520R7W   | 116    | 5505     | 158    | 5536     | 157  |
| 505PL-GS    | 210      | 520R9    | 118    | 5506     | 156    | 5536M    | 157  |
| 505PL-RS    | 210      | 520R9W   | 116    | 5507     | 158    | 5536NM   | 157  |
| 505PL-WS    | 210      | 5252DW   | 57     | 5508     | 156    | 5536W    | 157  |
| 505PL-YS    | 210      | 5261DW   | 57     | 5509     | 158    | 5537     | 159  |
| 505SK-2     | 210      | 5262DW   | 57     | 5518     | 157    | 5537M    | 159  |
| 505SK-3     | 210      | 5266     | 46, 53 | 5518W    | 157    | 5537NM   | 159  |
| 505SS-2     | 210      | 5266-RB  | 53     | 5519     | 159    | 5537W    | 159  |
| 505SS-3NC   | 210      | 5269     | 46, 53 | 5519W    | 159    | 5538     | 157  |
| 505SS-3NO   | 210      | 5269-RB  | 53     | 5520     | 157    | 5538M    | 157  |
| 505SW-1     | 210      | 5269L    | 55     | 5520W    | 157    | 5538NM   | 157  |
| 505SW-12NO  | 210      | 5276     | 46, 65 | 5521     | 159    | 5538W    | 157  |
| 505SW-1NONC | 210      | 530BA5   | 119    | 5521W    | 159    | 5539     | 159  |
| 505SW-2     | 210      | 530BA5W  | 117    | 5522     | 157    | 5539M    | 159  |
| 505SW-3     | 210      | 530BA7   | 119    | 5522M    | 157    | 5539NM   | 159  |
| 505SW-M     | 210      | 530BA7W  | 117    | 5522NM   | 157    | 5539W    | 159  |
| 505SW-N     | 210      | 530BA9   | 119    | 5522W    | 157    | 5540     | 157  |
| 505SW-NNONC | 210      | 530BA9W  | 117    | 5523     | 159    | 5540M    | 157  |
| 51-7272     | 6        | 530C5    | 119    | 5523M    | 159    | 5540NM   | 157  |
| 5100B5W     | 117      | 530C5W   | 117    | 5523NM   | 159    | 5540W    | 157  |
| 5100B7W     | 117      | 530C7    | 119    | 5523W    | 159    | 5541     | 159  |
| 5100B9W     | 117      | 530C7W   | 117    | 5524     | 157    | 5541M    | 159  |
| 5100C5W     | 117      | 530C9    | 119    | 5524M    | 157    | 5541NM   | 159  |
| 5100C7W     | 117      | 530C9W   | 117    | 5524NM   | 157    | 5541W    | 159  |
| 5100C9W     | 117      | 530MI5   | 119    | 5524W    | 157    | 5542     | 157  |
| 5100MI5W    | 117      | 530MI5W  | 117    | 5525     | 159    | 5542M    | 157  |
| 5100MI7W    | 117      | 530MI7   | 119    | 5525M    | 159    | 5542NM   | 157  |
| 5100MI9W    | 117      | 530MI7W  | 117    | 5525NM   | 159    | 5542W    | 157  |
| 5100P5W     | 117      | 530MI9   | 119    | 5525W    | 159    | 5543     | 159  |
| 5100P7W     | 117      | 530MI9W  | 117    | 5526     | 157    | 5543M    | 159  |
| 5100P9W     | 117      | 530P5    | 119    | 5526M    | 157    | 5543NM   | 159  |
| 5100R5W     | 117      | 530P5W   | 117    | 5526NM   | 157    | 5543W    | 159  |
| 5100R7W     | 117      | 530P7    | 119    | 5526W    | 157    | 5544     | 157  |
| 5100R9W     | 117      | 530P7W   | 117    | 5527     | 159    | 5544M    | 157  |
| 51149       | 226      | 530P9    | 119    | 5527M    | 159    | 5544W    | 157  |
| 5166        | 46, 49   | 530P9W   | 117    | 5527NM   | 159    | 5545     | 159  |
| 5169        | 46, 49   | 530R5    | 119    | 5527W    | 159    | 5545M    | 159  |
| 5176        | 46, 49   | 530R5W   | 117    | 5528     | 157    | 5545W    | 159  |
| 520BA5      | 118      | 530R7    | 119    | 5528M    | 157    | 5546     | 157  |
| 520BA5W     | 116      | 530R7W   | 117    | 5528NM   | 157    | 5546M    | 157  |
| 520BA7      | 118      | 530R9    | 119    | 5528W    | 157    | 5546NM   | 157  |
| 520BA7W     | 116      | 530R9W   | 117    | 5529     | 159    | 5546W    | 157  |
| 520BA9      | 118      | 5352DW   | 77     | 5529M    | 159    | 5547     | 159  |
| 520BA9W     | 116      | 5361DW   | 77     | 5529NM   | 159    | 5547M    | 159  |
| 520C5       | 118      | 5362DW   | 77     | 5529W    | 159    | 5547NM   | 159  |
| 520C5W      | 116      | 5366     | 46, 73 | 5530     | 157    | 5547W    | 159  |
| 520C7       | 118      | 5366-RB  | 73     | 5530M    | 157    | 5548     | 157  |

## ALPHANUMERIC LISTING OF PART NUMBERS

| PART NO. | PAGE | PART NO.  | PAGE | PART NO. | PAGE         | PART NO.    | PAGE        |
|----------|------|-----------|------|----------|--------------|-------------|-------------|
| 5548M    | 157  | 5571      | 159  | 560P7W   | 117          | 5769        | 46, 61      |
| 5548NM   | 157  | 5572      | 157  | 560P9    | 119          | 59W04       | 46, 50      |
| 5548W    | 157  | 5573      | 159  | 560P9W   | 117          | 59W07       | 46, 66      |
| 5549     | 159  | 5574      | 157  | 560R5    | 119          | 59W33       | 46, 76      |
| 5549M    | 159  | 5575      | 159  | 560R5W   | 117          | 59W34       | 46, 62      |
| 5549NM   | 159  | 5576      | 157  | 560R7    | 119          | 59W47       | 46, 56      |
| 5549W    | 159  | 5577      | 159  | 560R7W   | 117          | 59W48       | 46, 86      |
| 5550     | 157  | 5580      | 160  | 560R9    | 119          | 59W49       | 46, 62      |
| 55501    | 212  | 5580W     | 160  | 560R9W   | 117          | 600         | 43          |
| 55503    | 212  | 5581      | 160  | 5610     | 160          | 600SC       | 43          |
| 55504    | 212  | 5582      | 160  | 5611     | 160          | 601         | 43          |
| 5550M    | 157  | 5582W     | 160  | 5612     | 160          | 602         | 43          |
| 5550NM   | 157  | 5583      | 160  | 5613     | 160          | 603         | 43          |
| 5550W    | 157  | 5584      | 160  | 5614     | 160          | 606         | 43          |
| 5551     | 159  | 5585      | 160  | 5620     | 157          | 60W04       | 46, 50      |
| 5551M    | 159  | 5586      | 160  | 5620M    | 157          | 60W04DPLX   | 46, 50      |
| 5551NM   | 159  | 5587      | 160  | 5620NM   | 157          | 60W07       | 46, 66      |
| 5551W    | 159  | 5594-004  | 160  | 5620W    | 157          | 60W07DPLX   | 46, 66      |
| 5552     | 157  | 5594-004W | 160  | 5621     | 159          | 60W33       | 46, 76      |
| 5552M    | 157  | 5594-005  | 160  | 5621M    | 159          | 60W33DPLX   | 46, 76      |
| 5552NM   | 157  | 5594-005W | 160  | 5621NM   | 159          | 60W33DPLXGF | 76          |
| 5552W    | 157  | 5594-006  | 160  | 5621W    | 159          | 60W34       | 46, 62      |
| 5553     | 159  | 5594-006W | 160  | 5622     | 157          | 60W34DPLX   | 46, 62      |
| 5553M    | 159  | 5594-007  | 160  | 5622M    | 157          | 60W47       | 46, 56, 143 |
| 5553NM   | 159  | 5594-007W | 160  | 5622NM   | 157          | 60W47DPLX   | 46, 56, 143 |
| 5553W    | 159  | 5594-008  | 160  | 5622W    | 157          | 60W47DPLXGF | 56          |
| 5554     | 157  | 5594-008W | 160  | 5623     | 159          | 60W48       | 46, 86      |
| 5554M    | 157  | 5595-004  | 160  | 5623M    | 159          | 60W48DPLX   | 46, 86      |
| 5554NM   | 157  | 5595-004W | 160  | 5623NM   | 159          | 60W49       | 46, 62      |
| 5554W    | 157  | 5595-005  | 160  | 5623W    | 159          | 60W49DPLX   | 46, 62      |
| 5555     | 159  | 5595-005W | 160  | 5624     | 157          | 60W64       | 46, 115     |
| 5555M    | 159  | 5595-006  | 160  | 5624M    | 157          | 611         | 43          |
| 5555NM   | 159  | 5595-006W | 160  | 5624NM   | 157          | 61430       | 6           |
| 5555W    | 159  | 5595-007  | 160  | 5624W    | 157          | 61430A163   | 6           |
| 5556     | 157  | 5595-007W | 160  | 5625     | 159          | 61430B163   | 6           |
| 5556M    | 157  | 5595-008  | 160  | 5625M    | 159          | 61430D163   | 6           |
| 5556NM   | 157  | 5595-008W | 160  | 5625NM   | 159          | 61430RT     | 6           |
| 5556W    | 157  | 5599      | 160  | 5625W    | 159          | 61431       | 6           |
| 5557     | 159  | 5600      | 160  | 5628M    | 210          | 61432       | 6           |
| 5557M    | 159  | 5601      | 160  | 5630M    | 211          | 61435       | 6           |
| 5557NM   | 159  | 5602      | 160  | 5630NM   | 211          | 61436       | 6           |
| 5557W    | 159  | 5603      | 160  | 5631M    | 211          | 633         | 76          |
| 5558     | 157  | 5604      | 160  | 5631NM   | 211          | 6360CRN     | 46, 112     |
| 5558M    | 157  | 5609      | 160  | 5632M    | 211          | 6361CRN     | 46, 112     |
| 5558NM   | 157  | 560BA5    | 119  | 5632NM   | 211          | 6364CRN     | 46, 114     |
| 5558W    | 157  | 560BA5W   | 117  | 5633M    | 209-210, 213 | 6365CRN     | 46, 114     |
| 5559     | 159  | 560BA7    | 119  | 5633NM   | 209, 213     | 6369CR      | 46, 115     |
| 5559M    | 159  | 560BA7W   | 117  | 5634M    | 209, 213     | 6370CR      | 46, 113     |
| 5559NM   | 159  | 560BA9    | 119  | 5634NM   | 209, 213     | 6375CR      | 46, 115     |
| 5559W    | 159  | 560BA9W   | 117  | 5635M    | 209-210, 213 | 6377CR      | 46, 113     |
| 5560     | 157  | 560C5     | 119  | 5635NM   | 209, 213     | 63W60       | 46, 112     |
| 5560M    | 157  | 560C5W    | 117  | 5636M    | 209, 213     | 63W61       | 46, 112     |
| 5560NM   | 157  | 560C7     | 119  | 5636NM   | 209, 213     | 63W64       | 46, 114     |
| 5560W    | 157  | 560C7W    | 117  | 5637M    | 209, 213     | 63W65       | 46, 114     |
| 5561     | 159  | 560C9     | 119  | 5637NM   | 209, 213     | 647         | 56          |
| 5561M    | 159  | 560C9W    | 117  | 5638M    | 209, 213     | 648         | 86          |
| 5561NM   | 159  | 560M5     | 119  | 5638NM   | 209, 213     | 64W04       | 46, 50      |
| 5561W    | 159  | 560M5W    | 117  | 5639M    | 209, 213     | 64W07       | 46, 66      |
| 5562     | 157  | 560M7     | 119  | 5639NM   | 209, 213     | 64W34       | 46, 62      |
| 5562W    | 157  | 560M7W    | 117  | 5645M    | 210          | 64W47       | 46, 56      |
| 5563     | 159  | 560M9     | 119  | 5652DW   | 62           | 64W49       | 46, 62      |
| 5563W    | 159  | 560M9W    | 117  | 5662DW   | 62           | 64W64       | 46, 115     |
| 5568     | 157  | 560P5     | 119  | 5666     | 46, 61       | 65-0085     | 226, 242    |
| 5569     | 159  | 560P5W    | 117  | 5669     | 46, 61       | 65-0086     | 226, 242    |
| 5570     | 157  | 560P7     | 119  | 5766     | 46, 61       | 65W04       | 46, 50      |



MOST WOODHEAD PRODUCTS HAVE U.L. AND/OR CSA APPROVALS.  
FOR A LISTING OF APPROVALS BY PART NUMBER, SEE PAGES 248-257.

# APPENDIX

## ALPHANUMERIC LISTING OF PART NUMBERS

| PART NO.    | PAGE    | PART NO.      | PAGE          | PART NO.      | PAGE     | PART NO.    | PAGE         |
|-------------|---------|---------------|---------------|---------------|----------|-------------|--------------|
| 65W04DPLX   | 46, 50  | 69W81         | 46, 110       | 85366YL       | 75       | 914_123     | 201          |
| 65W07       | 46, 66  | 69W82         | 46, 110       | 85369         | 75       | 914_143     | 201          |
| 65W07DPLX   | 46, 66  | 69W83         | 46, 110       | 85369YL       | 75       | 915         | 201          |
| 65W34       | 46, 62  | 70-1350       | 16            | 8540M         | 42       | 915_123     | 201          |
| 65W34DPLX   | 46, 62  | 70-1351       | 18            | 8540P         | 42       | 915_143     | 201          |
| 65W47       | 46, 56  | 70-1352       | 18            | 85433         | 75       | 916         | 201          |
| 65W47DPLX   | 46, 56  | 70-3000       | 11            | 85433L        | 75       | 916_123     | 201          |
| 65W47DPLXGF | 56      | 70-3601       | 33            | 85447         | 55       | 916_143     | 201          |
| 65W49       | 46, 62  | 70-3602       | 33            | 85447L        | 55       | 920         | 201          |
| 65W49DPLX   | 46, 62  | 70-3603       | 33            | 8550M         | 42       | 9206        | 194          |
| 65W64       | 46, 115 | 70-3607       | 33            | 8550P         | 42       | 9208        | 194          |
| 66W07       | 46, 70  | 70W33A123     | 143           | 85547         | 55       | 920_123     | 201          |
| 66W08       | 46, 82  | 70W33L123     | 143           | 8565          | 29       | 920_143     | 201          |
| 66W09       | 46, 82  | 70W33M123     | 143           | 8565-MH       | 29       | 9224        | 194-197      |
| 66W10       | 46, 82  | 70W33_123GF   | 139           | 8565F         | 29       | 9224-106US  | 195          |
| 66W47       | 46, 76  | 70W47A143     | 143           | 8565F-MH      | 29       | 9224-1547   | 197          |
| 66W48       | 46, 86  | 70W47L143     | 143           | 8570P-56      | 30       | 9224-1610S  | 196          |
| 66W49       | 46, 86  | 70W47M143     | 143           | 8570P-56A163  | 30       | 9224-1621   | 195          |
| 66W64       | 46, 115 | 70W47_143GF   | 139           | 8570P-56B163  | 30       | 9224-86     | 195          |
| 66W74       | 46, 90  | 71-4220       | 209, 213, 219 | 8570P-56D163  | 30       | 9228        | 194-197      |
| 66W75       | 46, 90  | 75W47A143     | 143           | 8664          | 46, 112  | 9228-106US  | 195          |
| 66W76       | 46, 90  | 75W47L143     | 143           | 8665          | 46, 112  | 9228-1547   | 197          |
| 66W81       | 46, 94  | 75W47M143     | 143           | 883030A09M020 | 230      | 9228-1610S  | 196          |
| 66W82       | 46, 94  | 75W47_143GF   | 139           | 883031A09M020 | 230      | 9228-1621   | 195          |
| 66W83       | 46, 94  | 77W47A123     | 143           | 883032A09M020 | 230      | 9228-86     | 195          |
| 67W07       | 46, 70  | 77W47L123     | 143           | 883033A09M020 | 230      | 9234        | 194          |
| 67W07DPLX   | 46, 70  | 77W47M123     | 143           | 884030A09M020 | 230      | 9238        | 194          |
| 67W08       | 46, 82  | 77W47_123GF   | 139           | 884031A09M020 | 230      | 92401       | 194          |
| 67W09       | 46, 82  | 80011         | 232           | 884032A09M020 | 230      | 92402       | 194          |
| 67W10       | 46, 82  | 80013         | 232           | 884033A09M020 | 230      | 92411       | 194          |
| 67W47       | 46, 76  | 80015         | 232           | 885030A09M020 | 230      | 9242        | 194          |
| 67W47GF     | 76      | 803000A09M020 | 230           | 885031A09M020 | 230      | 92433       | 194, 196-197 |
| 67W48       | 46, 86  | 803001A09M020 | 230           | 885032A09M020 | 230      | 92433-1533  | 197          |
| 67W49       | 46, 86  | 803006A09M020 | 230           | 885033A09M020 | 230      | 92433-1547  | 197          |
| 67W64       | 46, 113 | 803007A09M020 | 230           | 8A4000-31     | 232      | 92433-3000  | 196          |
| 67W74       | 46, 90  | 804000A09M020 | 230           | 8A4000-32     | 232      | 92433-3070G | 197          |
| 67W75       | 46, 90  | 804001A09M020 | 230           | 8A4001-31     | 232      | 92433-3080  | 196          |
| 67W76       | 46, 90  | 804006A09M020 | 230           | 8A4006-31     | 232      | 92434       | 194          |
| 67W81       | 46, 94  | 804007A09M020 | 230           | 8A4006-32     | 232      | 92443       | 194          |
| 67W82       | 46, 94  | 805000A09M020 | 230           | 8A4007-31     | 232      | 92444       | 194          |
| 67W83       | 46, 94  | 805001A09M020 | 230           | 8A5000-31     | 232      | 92463       | 194          |
| 68W08       | 46, 102 | 805006A09M020 | 230           | 8A5000-32     | 232      | 92464       | 194          |
| 68W09       | 46, 102 | 805007A09M020 | 230           | 8A5001-31     | 232      | 92481       | 194          |
| 68W47       | 46, 98  | 8500          | 31            | 8A5006-31     | 232      | 92482       | 194          |
| 68W48       | 46, 98  | 85000         | 54            | 8A5006-32     | 232      | 92483       | 194          |
| 68W49       | 46, 98  | 85002         | 54            | 8A5007-31     | 232      | 92501AN     | 198          |
| 68W74       | 46, 106 | 8500M         | 31            | 8R3006A18A120 | 230      | 92502N      | 198          |
| 68W75       | 46, 106 | 8505          | 31            | 8R3A00A18A120 | 230      | 92511AN     | 198          |
| 68W76       | 46, 106 | 85050         | 55            | 8R4006A18A120 | 230, 232 | 92512AN     | 198          |
| 68W77       | 46, 106 | 85053         | 75            | 8R4A00A18A120 | 230, 232 | 92512BN     | 198          |
| 68W81       | 46, 110 | 8506          | 31            | 8R5006A18A120 | 230, 232 | 92526AN     | 198          |
| 68W82       | 46, 110 | 8506M         | 31            | 8R5A00A18A120 | 230, 232 | 92526BN     | 198          |
| 68W83       | 46, 110 | 8507          | 31            | 910           | 201      | 9253        | 194-197      |
| 69W08       | 46, 102 | 8510          | 31            | 910_123       | 201      | 9253-106US  | 195          |
| 69W09       | 46, 102 | 8511          | 31            | 910_143       | 201      | 9253-1547   | 197          |
| 69W47       | 46, 98  | 8512          | 31            | 911           | 201      | 9253-1610S  | 196          |
| 69W48       | 46, 98  | 85125         | 55            | 911_123       | 201      | 9253-1621   | 195          |
| 69W49       | 46, 98  | 85266         | 55            | 911_143       | 201      | 9253-3000   | 196          |
| 69W60       | 46, 113 | 85266YL       | 55            | 912           | 201      | 9253-3070G  | 197          |
| 69W62       | 46, 113 | 85269         | 55            | 912_122       | 201      | 92531N      | 198          |
| 69W64       | 46, 113 | 85269YL       | 55            | 912_142       | 201      | 92532N      | 198          |
| 69W74       | 46, 106 | 8530M         | 42            | 913           | 201      | 92533N      | 198          |
| 69W75       | 46, 106 | 8530P         | 42            | 913_123       | 201      | 92534N      | 198          |
| 69W76       | 46, 106 | 85366         | 75            | 913_143       | 201      | 92535AN     | 198          |
| 69W77       | 46, 106 | 85366ORG      | 75            | 914           | 201      | 92535BN     | 198          |



## ALPHANUMERIC LISTING OF PART NUMBERS

| PART NO. | PAGE | PART NO.   | PAGE         | PART NO.      | PAGE     | PART NO.    | PAGE    |
|----------|------|------------|--------------|---------------|----------|-------------|---------|
| 92536N   | 198  | 932B123    | 200          | 997           | 190, 193 | CS8164N     | 46, 114 |
| 92541N   | 198  | 932B143    | 200          | 997-3000      | 193      | CS8165N     | 46, 114 |
| 92542N   | 198  | 932B163    | 200          | 997-3070G     | 193      | CS8169      | 46, 115 |
| 92543N   | 198  | 932D123    | 200          | C03000A48M010 | 240      | CS8175      | 46, 115 |
| 92544AN  | 198  | 932D143    | 200          | C03001A48M010 | 240      | CS81W64     | 46, 114 |
| 92544BN  | 198  | 932D163    | 200          | C03006A48M010 | 240      | CS81W65     | 46, 114 |
| 92545AN  | 198  | 9358       | 194-197      | C03007A48M010 | 240      | CS8264N     | 46, 112 |
| 92546N   | 198  | 9358-106US | 195          | C03100A48M010 | 240      | CS8265N     | 46, 112 |
| 92561N   | 198  | 9358-1547  | 197          | C03101A48M010 | 240      | CS8269      | 46, 113 |
| 92562AN  | 198  | 9358-1610S | 196          | C03106A48M010 | 240      | CS8275      | 46, 113 |
| 92562BN  | 198  | 9358-1621  | 195          | C03107A48M010 | 240      | CS82W64     | 46, 112 |
| 92564N   | 198  | 9358-3000  | 196          | C04000A48M010 | 240      | CS82W65     | 46, 112 |
| 92581N   | 198  | 9358-3070G | 197          | C04001A48M010 | 240      | CS8364N     | 46, 114 |
| 92582N   | 198  | 9363       | 194          | C04006A48M010 | 240      | CS8365N     | 46, 114 |
| 92583N   | 198  | 9367       | 194          | C04007A48M010 | 240      | CS8369      | 46, 115 |
| 92584N   | 198  | 9383       | 194, 196-197 | C04100A48M010 | 240      | CS8375      | 46, 115 |
| 92625    | 199  | 9383-1533  | 197          | C04101A48M010 | 240      | CS83W64     | 46, 114 |
| 92631    | 199  | 9383-1547  | 197          | C04106A48M010 | 240      | CS83W65     | 46, 114 |
| 92632    | 199  | 9383-3000  | 196          | C04107A48M010 | 240      | CS8464N     | 46, 112 |
| 92633    | 199  | 9383-3070G | 197          | CC3030A48M010 | 240      | CS8465N     | 46, 112 |
| 92641    | 199  | 9383-3080  | 196          | CC3031A48M010 | 240      | CS8469      | 46, 113 |
| 92642    | 199  | 9385       | 194          | CC3032A48M010 | 240      | CS8475      | 46, 113 |
| 92643    | 199  | 9394       | 194          | CC3033A48M010 | 240      | CS84W64     | 46, 112 |
| 92661    | 199  | 945-1547   | 193          | CC3130A48M010 | 240      | CS84W65     | 46, 112 |
| 92663    | 198  | 945-3      | 190-193      | CC3131A48M010 | 240      | GFCI-INLINE | 132     |
| 92681    | 199  | 945-3-86   | 191          | CC3132A48M010 | 240      | N03FA03124  | 238     |
| 92702    | 199  | 95110      | 203          | CC3133A48M010 | 240      | N03FA04124  | 238     |
| 92712    | 199  | 95111      | 203          | CC4030A48M010 | 240      | N03MA03124  | 238     |
| 92725    | 199  | 95112      | 202          | CC4031A48M010 | 240      | N03MA04124  | 238     |
| 92726    | 199  | 95114      | 202          | CC4032A48M010 | 240      | N04FA03124  | 238     |
| 92732    | 199  | 95116      | 202          | CC4033A48M010 | 240      | N04FA04124  | 238     |
| 92733    | 199  | 95118      | 202          | CC4130A48M010 | 240      | N04MA03124  | 238     |
| 92734    | 199  | 95120      | 203          | CC4131A48M010 | 240      | N04MA04124  | 238     |
| 92735    | 199  | 95121      | 203          | CC4132A48M010 | 240      | SBG2500     | 31      |
| 92736    | 199  | 95122      | 202          | CC4133A48M010 | 240      | SBS2500     | 31      |
| 92742    | 199  | 95124      | 202          | CR3000A30M003 | 240      | STR100      | 39      |
| 92743    | 199  | 95126      | 202          | CR3006A30M003 | 240      | STR101      | 39      |
| 92744    | 199  | 95128      | 202          | CR3100A30M003 | 240      | STR102      | 39      |
| 92745    | 199  | 9521       | 197          | CR3106A30M003 | 240      | STR104      | 39      |
| 92746    | 199  | 9522       | 197          | CR3C00A30M003 | 240      | TC30130-001 | 240     |
| 92761    | 199  | 9523       | 197          | CR3C06A30M003 | 240      | TC30C30-001 | 240     |
| 92762    | 199  | 963        | 192          | CR3D00A30M003 | 240      | TC31130-001 | 240     |
| 92763    | 199  | 965        | 192          | CR3D06A30M003 | 240      | TC31C31-001 | 240     |
| 92764    | 199  | 966        | 193          | CR4000A30M003 | 240      | TC40140-001 | 240     |
| 92781    | 199  | 980        | 190-193      | CR4006A30M003 | 240      | TC40C40-001 | 240     |
| 92782    | 199  | 980-106US  | 192          | CR4100A30M003 | 240      | TC41140-001 | 240     |
| 92783    | 199  | 980-1547   | 193          | CR4106A30M003 | 240      | TC41C41-001 | 240     |
| 92784    | 199  | 980-1610S  | 192          | CR4C00A30M003 | 240      | WT3C-20     | 24      |
| 930      | 200  | 980-271US  | 191          | CR4C06A30M003 | 240      | WT3F-20     | 25      |
| 9306     | 194  | 980-3000   | 193          | CR4D00A30M003 | 240      | WT3F-20NS   | 25      |
| 9308     | 194  | 980-3070G  | 193          | CR4D06A30M003 | 240      | WT6C-25     | 22      |
| 930B123  | 200  | 980-83     | 190          | CS60W64       | 46, 115  | WT6C-50     | 22      |
| 930B143  | 200  | 980-86     | 191          | CS6360N       | 46, 112  | WT6F-25     | 23      |
| 930B163  | 200  | 980A-118   | 192          | CS6361N       | 46, 112  | WT6F-50     | 23      |
| 930D123  | 200  | 980A-83    | 191          | CS6364N       | 114      | Y560B       | 121     |
| 930D143  | 200  | 990        | 190-193      | CS6365N       | 114      | Y560CF      | 121     |
| 930D163  | 200  | 990-106US  | 192          | CS6369        | 46, 115  | Y560PF      | 121     |
| 931      | 200  | 990-1547   | 193          | CS6370        | 46, 113  | Y560R       | 121     |
| 931B123  | 200  | 990-271US  | 191          | CS6375        | 46, 115  | Y561B       | 121     |
| 931B143  | 200  | 990-3000   | 193          | CS6377        | 46, 113  | Y561R       | 121     |
| 931B163  | 200  | 990-3070G  | 193          | CS63W60       | 46, 112  |             |         |
| 931D123  | 200  | 990-83     | 190          | CS63W61       | 46, 112  |             |         |
| 931D143  | 200  | 990-86     | 191          | CS63W64       | 46, 114  |             |         |
| 931D163  | 200  | 990A-118   | 192          | CS63W65       | 46, 114  |             |         |
| 932      | 200  | 990A-83    | 191          | CS69W60       | 46, 113  |             |         |



MOST WOODHEAD PRODUCTS HAVE U.L. AND/OR CSA APPROVALS.  
FOR A LISTING OF APPROVALS BY PART NUMBER, SEE PAGES 248-257.

# Woodhead....For Whatever Your World Demands



When specifying, demand electrical wiring devices that..

- Endure regular punishment on the job,
- Help protect the safety of workers,
- Keep the current flowing to meet your deadlines,
- Won't blow the budget.

For value that's out of this world, specify Woodhead® wiring devices. Consistently toughest in every class, Woodhead wiring devices are backed by an 80 year commitment to excellence and quality.

Order today! For a Free brochure on the complete family of Woodhead wiring devices, call or visit our website.

**W** | **Woodhead**

[www.woodhead.com](http://www.woodhead.com) 1.800.225.7724



## **WARRANTY, DISCLAIMERS, LIMITATION OF LIABILITY**

All products sold by Woodhead L.P. are manufactured to be free from defects in material and workmanship for a period of twelve (12) months from date of delivery, provided there has been normal use. Should any defect in material or workmanship occur during the above time period in any part of any product, as determined by Woodhead L.P.'s inspection of the defective part, Woodhead L.P. agrees, in its discretion, either to replace (excluding removal and installation charges) or repair the defective part free of charge and to deliver said part F.O.B. Woodhead L.P.'s place of business; provided, however, that Buyer (i) gives prompt notice to Woodhead L.P. of the defect, (ii) establishes its normal use and service of the product, and (iii) returns such defective part to Woodhead L.P. at Buyer's own expense. WOODHEAD L.P. EXPRESSLY DISCLAIMS ANY AND ALL OTHER WARRANTIES OF ANY KIND WHATSOEVER AS TO THE PRODUCTS, INCLUDING, BUT NOT LIMITED TO, EXPRESS OR IMPLIED WARRANTIES AS TO MERCHANTABILITY, FITNESS FOR PURPOSES SOLD, AND DESCRIPTION OR QUALITY OF THE PRODUCTS.

Any specifications described herein, or in any of Woodhead L.P.'s written proposals, are only estimates and are not intended as an express warranty. Any samples submitted by Woodhead L.P. to Buyer, and any descriptions, illustrations, or forecasts in trade literature, brochures, or other documentation shall not be construed as warranties as to substance, performance, color, quality or dimension, and any failure to conform with such samples, descriptions, or illustrations shall not constitute any breach of these terms and conditions by Woodhead L.P.

In no event shall Woodhead L.P. be liable for any damages, ordinary, incidental, or consequential, including, but not limited to, damages for loss of production, loss of anticipated profits or savings, or for any claims asserted against Buyer by a third party arising directly or indirectly out of or in connection with the manufacture, sale, use, or defect of the products. Buyer's sole remedy shall be the terms of the warranty set forth above.

Notwithstanding anything to the contrary, where any product is delivered to Buyer that does not comply with the agreed upon terms between Buyer and Woodhead L.P., or in the event of any loss or damage howsoever arising out of the products, the aggregate liability of Woodhead L.P. to Buyer shall be limited to and shall not exceed a sum which equals the price of the products upon which such liability is based.

Waterite, Super-Safeway, Safeway, Safeway +, Pro-Yellow, Safety Yellow, Tubelite, MAX-LOC, NETEX, HAZTEX, Safe-T-Check, Multi-Tap, Brad, Brad Harrison, Brad Power, Mini-Change, Micro-Change, Nano-Change, and Quick-Change are registered trademarks of Woodhead Industries, Inc.

WTQ is a trademark of Woodhead Industries, Inc.



Contact us for more information on other exciting product families from Woodhead.

## INDUSTRIAL



AERO-MOTIVE®

## PASSIVE MEDIA



BRAD HARRISON® - MPM®

## NETWORK MEDIA



BRAD HARRISON® - RJ LNXX®

## SOFTWARE & ELECTRONICS



APPLICOM® - SST™ - DIRECT LINK™

## NORTH AMERICA

### UNITED STATES

WOODHEAD L.P.  
3411 Woodhead Drive  
Northbrook, Illinois 60062  
Telephone: +1 (847) 272-7990  
Fax: +1 (847) 272-8133

### EUROPE

#### UNITED KINGDOM

WOODHEAD CONNECTIVITY LIMITED  
Factory No. 9  
Rossa Industrial Estate  
Ebbw Vale, Gwent,  
Wales NP23 5SD  
Tel: +44 1495 356300  
Fax: +44 1495 356301

### CANADA

WOODHEAD CANADA LIMITED  
1000 Break Place  
Mississauga, Ontario L4W 3Y5  
Tel: +1 (905) 624-6515  
Fax: +1 (905) 624-9151

### ASIA

#### SINGAPORE

WOODHEAD ASIA PTE. LTD.  
4 Top Tuck Link Level 3, Mezzanine  
Markon Logistics Building  
Singapore 596226  
Tel: +65 6261-6533  
Fax: +65 6261-3668

### MEXICO

WOODHEAD DE MEXICO S.A. DE C.V.  
Av. Presidente Mazarzyk 61-2 Pta  
Cd. Chapultepec Morales  
11560 Mexico, D.F.  
Tel: +52 5254-7284  
Fax: +52 5251-2287

**W** | Woodhead  
[www.woodhead.com](http://www.woodhead.com)

© 2004 Woodhead Industries, Inc.  
DW3E  
10CM DBH 0004

Компания «Life Electronics» занимается поставками электронных компонентов импортного и отечественного производства от производителей и со складов крупных дистрибьюторов Европы, Америки и Азии.

С конца 2013 года компания активно расширяет линейку поставок компонентов по направлению коаксиальный кабель, кварцевые генераторы и конденсаторы (керамические, пленочные, электролитические), за счёт заключения дистрибьюторских договоров

Мы предлагаем:

- Конкурентоспособные цены и скидки постоянным клиентам.
- Специальные условия для постоянных клиентов.
- Подбор аналогов.
- Поставку компонентов в любых объемах, удовлетворяющих вашим потребностям.
- Приемлемые сроки поставки, возможна ускоренная поставка.
- Доставку товара в любую точку России и стран СНГ.
- Комплексную поставку.
- Работу по проектам и поставку образцов.
- Формирование склада под заказчика.
- Сертификаты соответствия на поставляемую продукцию (по желанию клиента).
- Тестирование поставляемой продукции.
- Поставку компонентов, требующих военную и космическую приемку.
- Входной контроль качества.
- Наличие сертификата ISO.

В составе нашей компании организован Конструкторский отдел, призванный помогать разработчикам, и инженерам.

Конструкторский отдел помогает осуществить:

- Регистрацию проекта у производителя компонентов.
- Техническую поддержку проекта.
- Защиту от снятия компонента с производства.
- Оценку стоимости проекта по компонентам.
- Изготовление тестовой платы монтаж и пусконаладочные работы.



Тел: +7 (812) 336 43 04 (многоканальный)  
Email: [org@lifeelectronics.ru](mailto:org@lifeelectronics.ru)