

FEATURES

- 1.5 pF off capacitance
- 0.5 pC charge injection
- 33 V supply range
- 120 Ω on resistance
- Fully specified at ± 15 V/+12 V
- 3 V logic-compatible inputs
- Rail-to-rail operation
- Break-before-make switching action
- 16-lead TSSOP, 20-lead TSSOP, and 4 mm \times 4 mm LFCSP
- Typical power consumption (<0.03 μ W)

APPLICATIONS

- Audio and video routing
- Automatic test equipment
- Data acquisition systems
- Battery-powered systems
- Sample-and-hold systems
- Communication systems

GENERAL DESCRIPTION

The [ADG1233](#) and [ADG1234](#) are monolithic *i*CMOS[®] analog switches comprising three independently selectable single-pole, double throw SPDT switches and four independently selectable SPDT switches, respectively.

All channels exhibit break-before-make switching action preventing momentary shorting when switching channels. An \overline{EN} input on the [ADG1233](#) and [ADG1234](#) enables or disables the device. When disabled, all channels are switched off.

The *i*CMOS (industrial-CMOS) modular manufacturing process combines a high voltage complementary metal-oxide semiconductor (CMOS) and bipolar technologies. It enables the development of a wide range of high performance analog ICs capable of 33 V operation in a footprint that no other generation of high voltage devices has been able to achieve.

Rev. D

[Document Feedback](#)

Information furnished by Analog Devices is believed to be accurate and reliable. However, no responsibility is assumed by Analog Devices for its use, nor for any infringements of patents or other rights of third parties that may result from its use. Specifications subject to change without notice. No license is granted by implication or otherwise under any patent or patent rights of Analog Devices. Trademarks and registered trademarks are the property of their respective owners.

FUNCTIONAL BLOCK DIAGRAMS

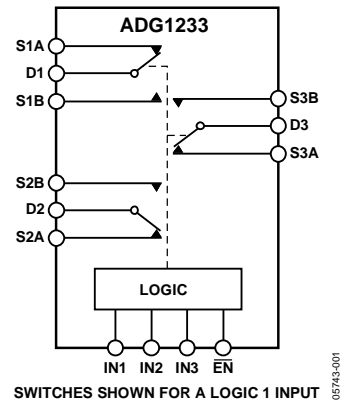

Figure 1.

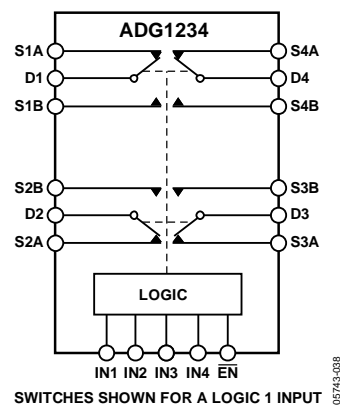

Figure 2.

Unlike analog ICs using conventional CMOS processes, *i*CMOS components can tolerate high supply voltages while providing increased performance, dramatically lowered power consumption, and reduced package size.

The ultralow capacitance and charge injection of these multiplexers make them ideal solutions for data acquisition and sample-and-hold applications, where low glitch and fast settling are required.

Fast switching speed coupled with high signal bandwidth make the devices suitable for video signal switching. *i*CMOS construction ensures ultralow power dissipation, making the devices ideally suited for portable and battery-powered instruments.

PRODUCT HIGHLIGHTS

1. 1.5 pF off capacitance (± 15 V supply).
2. 0.5 pC charge injection.
3. 3 V logic-compatible digital input, $V_{IH} = 2.0$ V, $V_{IL} = 0.8$ V.
4. 16-lead TSSOP, 20-lead TSSOP, and 4 mm \times 4 mm LFCSP.

TABLE OF CONTENTS

Features	1	Absolute Maximum Ratings	7
Applications.....	1	ESD Caution.....	7
Functional Block Diagrams.....	1	Pin Configurations and Function Descriptions	8
General Description	1	Terminology	10
Product Highlights	1	Typical Performance Characteristics	11
Revision History	2	Test Circuits.....	14
Specifications.....	3	Outline Dimensions	16
Dual Supply	3	Ordering Guide	17
Single Supply	5		

REVISION HISTORY

8/2016—Rev. C to Rev. D

Changes to Analog Inputs Parameter and Digital Inputs Parameter, Table 3.....	7
Updated Outline Dimensions	17

3/2016—Rev. B to Rev. C

Changes to Figure 5 and Figure 6.....	9
Updated Outline Dimensions	17
Changes to Ordering Guide	17

2/2009—Rev. A to Rev. B

Change to I _{DD} Parameter, Table 1	4
Change to I _{DD} Parameter, Table 2	6
Updated Outline Dimensions	16

8/2006—Rev. 0 to Rev. A

Updated Format.....	\Universal
Changes to Table 1.....	13
Changes to Table 2.....	14
Changes to Figure 11.....	110
Changes to Figure 12.....	111

1/2006—Revision 0: Initial Version

SPECIFICATIONS

DUAL SUPPLY

$V_{DD} = +15\text{ V} \pm 10\%$, $V_{SS} = -15\text{ V} \pm 10\%$, $GND = 0\text{ V}$, unless otherwise noted.

Table 1.

Parameter	Y Version ¹			Unit	Test Conditions/Comments
	+25°C	-40°C to +85°C	-40°C to +125°C		
ANALOG SWITCH					
Analog Signal Range			V_{SS} to V_{DD}	V	
On Resistance (R_{ON})	120			Ω typ	$V_S = \pm 10\text{ V}$, $I_S = -1\text{ mA}$; see Figure 24
	190	230	260	Ω max	$V_{DD} = +13.5\text{ V}$, $V_{SS} = -13.5\text{ V}$
On Resistance Match Between Channels (ΔR_{ON})	3.5			Ω typ	$V_S = \pm 10\text{ V}$, $I_S = -1\text{ mA}$
	6	10	12	Ω max	
On Resistance Flatness ($R_{FLAT(ON)}$)	20			Ω typ	$V_S = -5\text{ V}, 0\text{ V}, +5\text{ V}$; $I_S = -1\text{ mA}$
	60	72	79	Ω max	
LEAKAGE CURRENTS					
Source Off Leakage I_S (Off)	± 0.02			nA typ	$V_{DD} = +16.5\text{ V}$, $V_{SS} = -16.5\text{ V}$
	± 0.1	± 0.6	± 1	nA max	$V_D = \pm 10\text{ V}$, $V_S = -10\text{ V}$; see Figure 25
Drain Off Leakage I_D (Off)	± 0.02			nA typ	$V_S = 1\text{ V}/10\text{ V}$, $V_D = 10\text{ V}/1\text{ V}$; see Figure 25
	± 0.1	± 0.6	± 1	nA max	
Channel On Leakage I_D, I_S (On)	± 0.02			nA typ	$V_S = V_D = \pm 10\text{ V}$; see Figure 26
	± 0.2	± 0.6	± 1	nA max	
DIGITAL INPUTS					
Input High Voltage, V_{INH}			2.0	V min	
Input Low Voltage, V_{INL}			0.8	V max	
Input Current					
I_{INL} or I_{INH}	± 0.005			μA typ	$V_{IN} = V_{INL}$ or V_{INH}
			± 0.1	μA max	
Digital Input Capacitance, C_{IN}	3			pF typ	
DYNAMIC CHARACTERISTICS²					
$t_{TRANSITION}$	110			ns typ	$R_L = 300\ \Omega$, $C_L = 35\text{ pF}$
	130	150	170	ns max	$V_S = 10\text{ V}$; see Figure 27
t_{BBM}	25			ns typ	$R_L = 300\ \Omega$, $C_L = 35\text{ pF}$
			10	ns min	$V_{S1} = V_{S2} = +10\text{ V}$; see Figure 28
$t_{ON}(\overline{EN})$	120			ns typ	$R_L = 300\ \Omega$, $C_L = 35\text{ pF}$
	140	170	195	ns max	$V_S = 10\text{ V}$; see Figure 29
$t_{OFF}(\overline{EN})$	40			ns typ	$R_L = 300\ \Omega$, $C_L = 35\text{ pF}$
	45	55	60	ns max	$V_S = 10\text{ V}$; see Figure 29
Charge Injection	0.5			pC typ	$V_S = 0\text{ V}$, $R_S = 0\ \Omega$, $C_L = 1\text{ nF}$; see Figure 30
Off Isolation	-80			dB typ	$R_L = 50\ \Omega$, $C_L = 5\text{ pF}$, $f = 1\text{ MHz}$; see Figure 31
Channel-to-Channel Crosstalk	-85			dB typ	$R_L = 50\ \Omega$, $C_L = 5\text{ pF}$, $f = 1\text{ MHz}$; see Figure 33
Total Harmonic Distortion, THD + N	0.14			% typ	$R_L = 10\text{ k}\Omega$, 5 V rms , $f = 20\text{ Hz}$ to 20 kHz ; see Figure 34
-3 dB Bandwidth	900			MHz typ	$R_L = 50\ \Omega$, $C_L = 5\text{ pF}$; see Figure 32
C_S (Off)	1.5			pF typ	$f = 1\text{ MHz}$; $V_S = 0\text{ V}$
	1.7			pF max	$f = 1\text{ MHz}$; $V_S = 0\text{ V}$
C_D (Off)	1.6			pF typ	$f = 1\text{ MHz}$; $V_S = 0\text{ V}$
	1.8			pF max	$f = 1\text{ MHz}$; $V_S = 0\text{ V}$

Parameter	Y Version ¹			Unit	Test Conditions/Comments
	+25°C	-40°C to +85°C	-40°C to +125°C		
C _D , C _S (On)	3.5 4			pF typ pF max	f = 1 MHz; V _S = 0 V f = 1 MHz; V _S = 0 V
POWER REQUIREMENTS					
I _{DD}	0.002		1.0	μA typ μA max	V _{DD} = +16.5 V, V _{SS} = -16.5 V Digital inputs = 0 V or V _{DD}
I _{DD}	260		475	μA typ μA max	Digital inputs = 5 V
I _{SS}	0.002		1.0	μA typ μA max	Digital inputs = 0 V or V _{DD}
I _{SS}	0.002		1.0	μA typ μA max	Digital inputs = 5 V
V _{DD} /V _{SS}			±5/±16.5	V min/max	GND = 0 V

¹ Temperature range for the Y version: -40°C to +125°C.

² Guaranteed by design, not subject to production test.

SINGLE SUPPLY

$V_{DD} = 12\text{ V} \pm 10\%$, $V_{SS} = 0\text{ V}$, $GND = 0\text{ V}$, unless otherwise noted.

Table 2.

Parameter	Y Version ¹			Unit	Test Conditions/Comments
	+25°C	−40°C to +85°C	−40°C to +125°C		
ANALOG SWITCH					
Analog Signal Range			0 to V_{DD}	V	
On Resistance (R_{ON})	300			Ω typ	$V_S = 0\text{ V}$ to 10 V , $I_S = -1\text{ mA}$; see Figure 24
On Resistance Match Between Channels (ΔR_{ON})	475	567	625	Ω max	$V_{DD} = 10.8\text{ V}$, $V_{SS} = 0\text{ V}$
	5			Ω typ	$V_S = 0\text{ V}$ to 10 V , $I_S = -1\text{ mA}$
On Resistance Flatness ($R_{FLAT(ON)}$)	16	26	27	Ω max	
	60			Ω typ	$V_S = 3\text{ V}$, 6 V , 9 V , $I_S = -1\text{ mA}$
LEAKAGE CURRENTS					
Source Off Leakage I_S (Off)	± 0.02			nA typ	$V_{DD} = 13.2\text{ V}$ $V_S = 1\text{ V}/10\text{ V}$, $V_D = 10\text{ V}/1\text{ V}$; see Figure 25
Drain Off Leakage I_D (Off)	± 0.1 ± 0.02	± 0.6	± 1	nA max nA typ	$V_S = 1\text{ V}/10\text{ V}$, $V_D = 10\text{ V}/1\text{ V}$; see Figure 25
Channel On Leakage I_D, I_S (On)	± 0.1 ± 0.02 ± 0.2	± 0.6	± 1	nA max nA typ nA max	$V_S = V_D = 1\text{ V}$ or 10 V , see Figure 26
DIGITAL INPUTS					
Input High Voltage, V_{INH}			2.0	V min	
Input Low Voltage, V_{INL}			0.8	V max	
Input Current, I_{INL} or I_{INH}	± 0.001			μA typ μA max	$V_{IN} = V_{INL}$ or V_{INH}
Digital Input Capacitance, C_{IN}	2			pF typ	
DYNAMIC CHARACTERISTICS²					
$t_{TRANSITION}$	135			ns typ	$R_L = 300\ \Omega$, $C_L = 35\text{ pF}$ $V_S = 8\text{ V}$; see Figure 27
	170	200	230		
t_{BBM}	45			ns typ	$R_L = 300\ \Omega$, $C_L = 35\text{ pF}$
			10	ns min	$V_{S1} = V_{S2} = 8\text{ V}$; see Figure 28
$t_{ON}(\overline{EN})$	150			ns typ	$R_L = 300\ \Omega$, $C_L = 35\text{ pF}$
	195	230	265		$V_S = 8\text{ V}$; see Figure 29
$t_{OFF}(\overline{EN})$	45			ns typ	$R_L = 300\ \Omega$, $C_L = 35\text{ pF}$
	60	70	75		$V_S = 8\text{ V}$; see Figure 29
Charge Injection	−0.3			pC typ	$V_S = 6\text{ V}$, $R_S = 0\ \Omega$, $C_L = 1\text{ nF}$; see Figure 30
Off Isolation	−80			dB typ	$R_L = 50\ \Omega$, $C_L = 5\text{ pF}$, $f = 1\text{ MHz}$; see Figure 31
Channel-to-Channel Crosstalk	−85			dB typ	$R_L = 50\ \Omega$, $C_L = 5\text{ pF}$, $f = 1\text{ MHz}$; see Figure 33
−3 dB Bandwidth	600			MHz typ	$R_L = 50\ \Omega$, $C_L = 5\text{ pF}$; see Figure 32
C_S (Off)	1.5			pF typ	$f = 1\text{ MHz}$; $V_S = 6\text{ V}$
	1.7			pF max	$f = 1\text{ MHz}$; $V_S = 6\text{ V}$
C_D (Off)	2			pF typ	$f = 1\text{ MHz}$; $V_S = 6\text{ V}$
	2.2			pF max	$f = 1\text{ MHz}$; $V_S = 6\text{ V}$
C_D, C_S (On)	4			pF typ	$f = 1\text{ MHz}$; $V_S = 6\text{ V}$
	4.5			pF max	$f = 1\text{ MHz}$; $V_S = 6\text{ V}$

Parameter	Y Version ¹			Unit	Test Conditions/Comments
	+25°C	-40°C to +85°C	-40°C to +125°C		
POWER REQUIREMENTS					$V_{DD} = 13.2\text{ V}$
I_{DD}	0.002			$\mu\text{A typ}$	Digital inputs = 0 V or V_{DD}
			1.0	$\mu\text{A max}$	
I_{DD}	260			$\mu\text{A typ}$	Digital inputs = 5 V
			475	$\mu\text{A max}$	
V_{DD}			5/16.5	V min/max	$V_{SS} = 0\text{ V}, \text{GND} = 0\text{ V}$

¹ Temperature range for the Y version: -40°C to +125°C

² Guaranteed by design, not subject to production test.

ABSOLUTE MAXIMUM RATINGS

$T_A = 25^\circ\text{C}$, unless otherwise noted.

Table 3.

Parameter	Rating
V_{DD} to V_{SS}	35 V
V_{DD} to GND	-0.3 V to +25 V
V_{SS} to GND	+0.3 V to -25 V
Analog Inputs ¹	$V_{SS} - 0.3\text{ V}$ to $V_{DD} + 0.3\text{ V}$ or 30 mA (whichever occurs first)
Digital Inputs	GND - 0.3 V to $V_{DD} + 0.3\text{ V}$ or 30 mA (whichever occurs first)
Continuous Current, S or D	24 mA
Peak Current, S or D (Pulsed at 1 ms, 10% Duty Cycle Maximum)	100 mA
Operating Temperature Range	
Automotive Temperature Range (Y Version)	-40°C to +125°C
Storage Temperature Range	-65°C to +150°C
Junction Temperature	150°C
TSSOP, θ_{JA} , Thermal Impedance	112°C/W
LFCSP, θ_{JA} , Thermal Impedance	30.4°C/W
Reflow Soldering Peak Temperature, Pb-Free	260°C

¹ Overvoltages at A, $\overline{\text{EN}}$, S, or D are clamped by internal diodes. Current must be limited to the maximum ratings given.

Stresses at or above those listed under Absolute Maximum Ratings may cause permanent damage to the product. This is a stress rating only; functional operation of the product at these or any other conditions above those indicated in the operational section of this specification is not implied. Operation beyond the maximum operating conditions for extended periods may affect product reliability.

Only one absolute maximum rating is applied at any one time.

ESD CAUTION



ESD (electrostatic discharge) sensitive device.

Charged devices and circuit boards can discharge without detection. Although this product features patented or proprietary protection circuitry, damage may occur on devices subjected to high energy ESD. Therefore, proper ESD precautions should be taken to avoid performance degradation or loss of functionality.

PIN CONFIGURATIONS AND FUNCTION DESCRIPTIONS

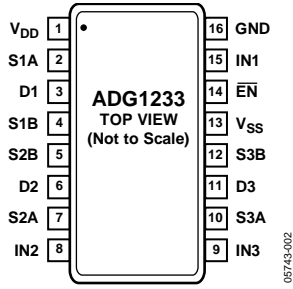

Figure 3. 16-Lead TSSOP Pin Configuration



Figure 4. 20-Lead TSSOP Pin Configuration

Table 4. 16-Lead TSSOP/20-Lead TSSOP Pin Configurations

Pin No. ADG1233 16-Lead TSSOP	Pin No. ADG1234 20-Lead TSSOP	Mnemonic
1	16	V _{DD}
2	2	S1A
3	3	D1
4	4	S1B
5	7	S2B
6	8	D2
7	9	S2A
8	10	IN2
9	11	IN3
10	12	S3A
11	13	D3
12	14	S3B
13	5	V _{SS}
14	15	EN
15	1	IN1
16	6	GND
Not applicable	17	S4B
Not applicable	18	D4
Not applicable	19	S4A
Not applicable	20	IN4

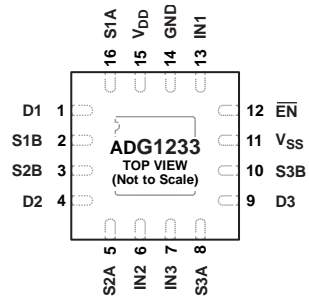

- NOTES
1. NC = NO CONNECT. DO NOT CONNECT TO THIS PIN.
 2. THE EXPOSED PAD MUST BE TIED TO SUBSTRATE, V_{SS} .

05743-004

Figure 5. 16-Lead, 4 mm x 4 mm LFCSP Pin Configuration, Exposed Pad Tied to Substrate, V_{SS}

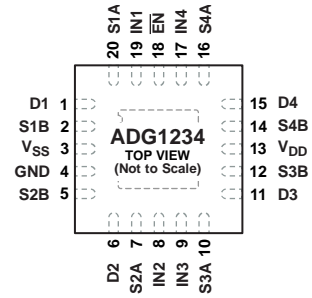

- NOTES
1. THE EXPOSED PAD MUST BE TIED TO SUBSTRATE, V_{SS} .

05743-005

Figure 6. 20-Lead, 4 mm x 4 mm LFCSP Pin Configuration, Exposed Pad Tied to Substrate, V_{SS}

Table 5. 16-Lead LFCSP/20-Lead LFCSP Pin Configurations

Pin No. ADG1233 16-Lead LFCSP	Pin No. ADG1234 20-Lead LFCSP	Mnemonic
1	1	D1
2	2	S1B
3	5	S2B
4	6	D2
5	7	S2A
6	8	IN2
7	9	IN3
8	10	S3A
9	11	D3
10	12	S3B
11	3	V_{SS}
12	18	\overline{EN}
13	19	IN1
14	4	GND
15	13	V_{DD}
16	20	S1A
Not applicable	14	S4B
Not applicable	15	D4
Not applicable	16	S4A
Not applicable	17	IN4

Table 6. **ADG1233/ADG1234** Truth Table

\overline{EN}	INx	Switch xA	Switch xB
1	X	Off	Off
0	0	Off	On
0	1	On	Off

TERMINOLOGY

V_{DD}

Most positive supply potential.

V_{SS}

Most negative power supply potential in dual supplies. In single-supply applications, it can be connected to ground.

GND

Ground (0 V) reference.

R_{ON}

Ohmic resistance between D and S.

ΔR_{ON}

Difference between the R_{ON} of any two channels.

I_S (Off)

Source leakage current when switch is off.

I_D (Off)

Drain leakage current when switch is off.

I_D, I_S (On)

Channel leakage current when switch is on.

V_D, V_S

Analog voltage on Terminal D, Terminal S.

C_S (Off)

Channel input capacitance for off condition.

C_D (Off)

Channel output capacitance for off condition.

C_D, C_S (On)

On switch capacitance.

C_{IN}

Digital input capacitance.

$t_{ON}(\overline{EN})$

Delay time between the 50% and 90% points of the digital input and switch on condition.

$t_{OFF}(\overline{EN})$

Delay time between the 50% and 90% points of the digital input and switch off condition.

$t_{TRANSITION}$

Delay time between the 50% and 90% points of the digital inputs and the switch on condition when switching from one address state to another.

t_{BBM}

Off time measured between the 80% point of both switches when switching from one address state to another.

V_{INL}

Maximum input voltage for Logic 0.

V_{INH}

Minimum input voltage for Logic 1.

I_{INL}, I_{INH}

Input current of the digital input.

I_{DD}

Positive supply current.

I_{SS}

Negative supply current.

Off Isolation

A measure of an unwanted signal coupling through an off channel.

Charge Injection

A measure of the glitch impulse transferred from the digital input to the analog output during switching.

Bandwidth

Frequency at which the output is attenuated by 3 dB.

On Response

Frequency response of the on switch.

THD + N

Ratio of the harmonic amplitude plus noise of the signal to the fundamental.

TYPICAL PERFORMANCE CHARACTERISTICS

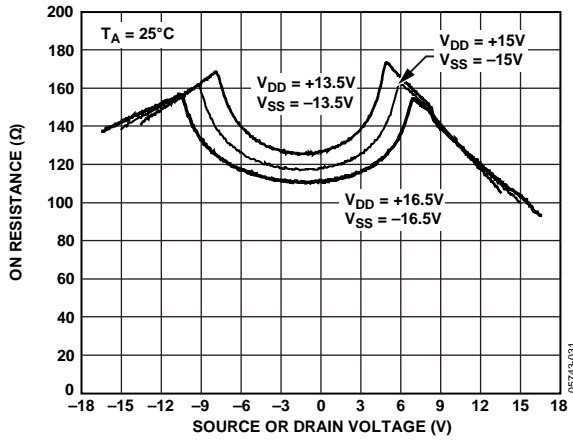

Figure 7. On Resistance as a Function of V_D (V_S) for Dual Supply



Figure 10. On Resistance as a Function of V_D (V_S) for Different Temperatures, Dual Supply

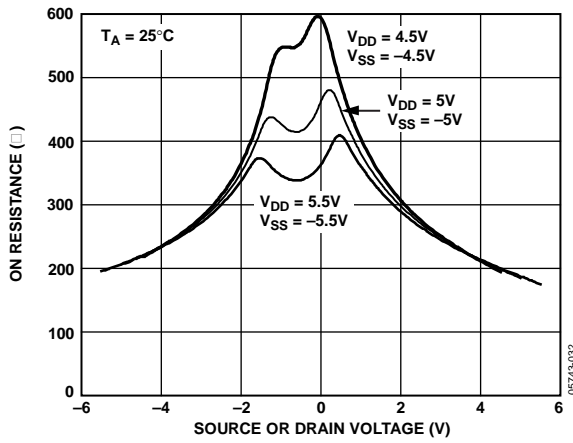

Figure 8. On Resistance as a Function of V_D (V_S) for Dual Supply

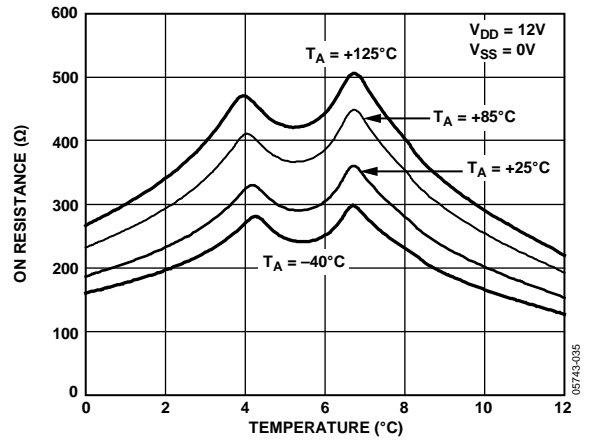

Figure 11. On Resistance as a Function of V_D (V_S) for Different Temperatures, Single Supply

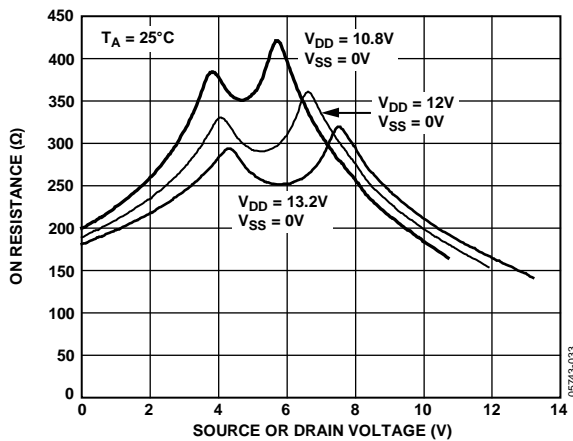

Figure 9. On Resistance as a Function of V_D (V_S) for Single Supply

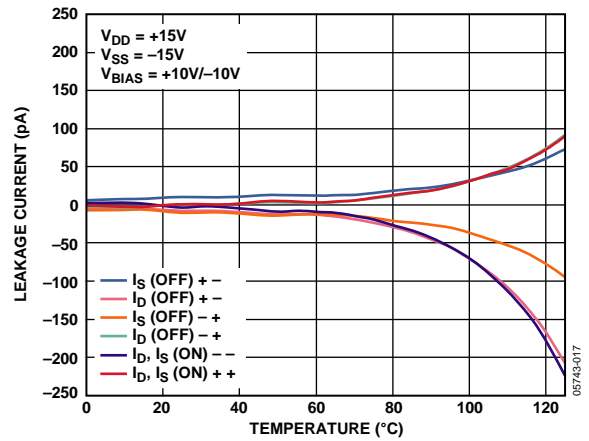

Figure 12. Leakage Currents as a Function of Temperature, Dual Supply



Figure 13. Leakage Currents as a Function of Temperature, Single Supply



Figure 16. $t_{TRANSITION}$ vs. Temperature



Figure 14. I_{DD} vs. Logic Level



Figure 17. Off Isolation vs. Frequency



Figure 15. Charge Injection vs. Source Voltage



Figure 18. Crosstalk vs. Frequency

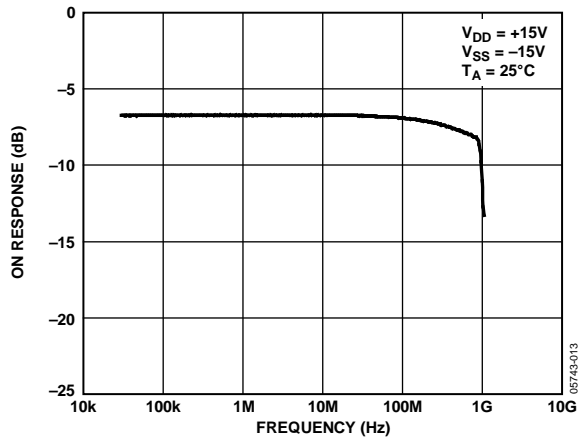

Figure 19. On Response vs. Frequency

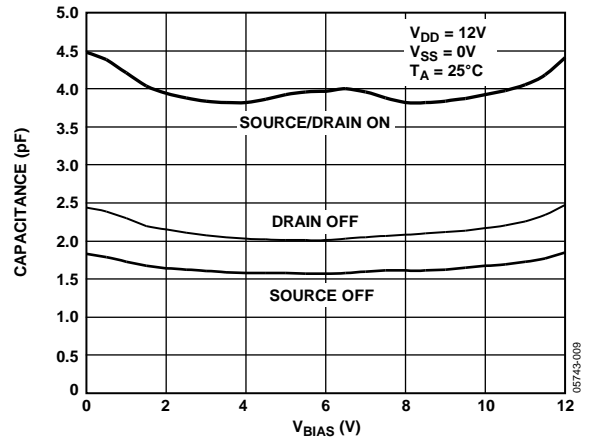

Figure 22. Capacitance vs. Source Voltage for Single Supply

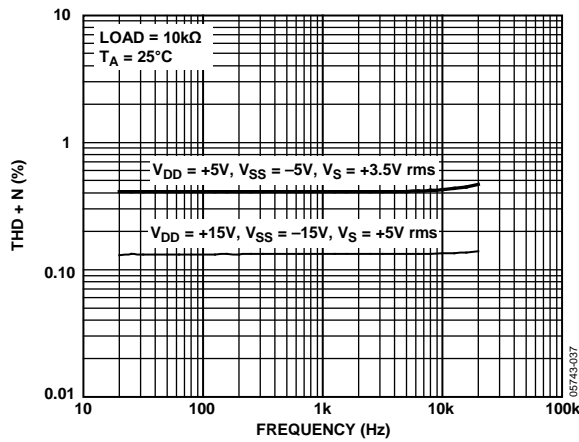

Figure 20. THD + N vs. Frequency

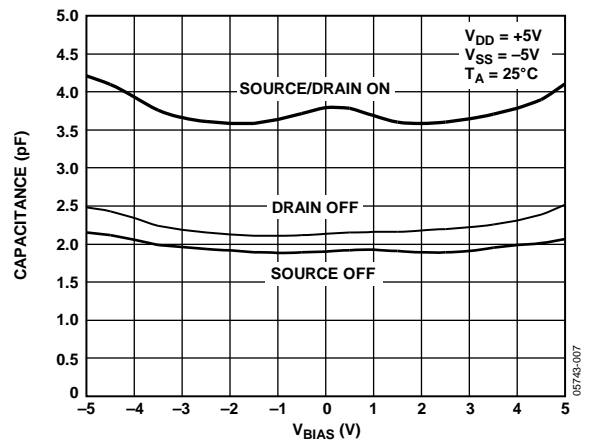

Figure 23. Capacitance vs. Source Voltage for Dual Supply

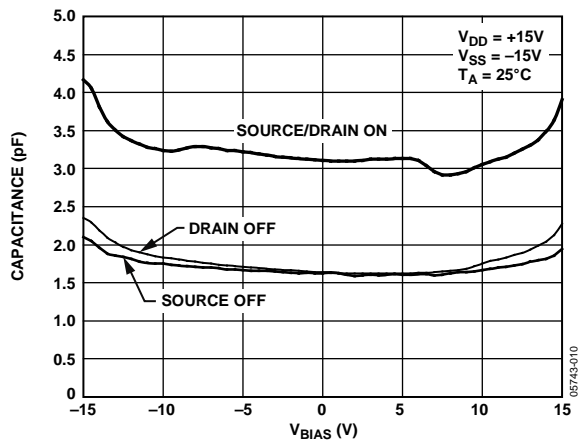

Figure 21. Capacitance vs. Source Voltage for Dual Supply

TEST CIRCUITS



Figure 24. On Resistance



Figure 25. Off Leakage

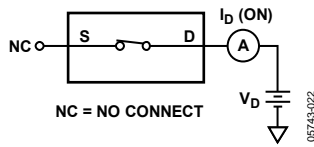

Figure 26. On Leakage



Figure 27. Switching Timing



Figure 28. Break-Before-Make Delay

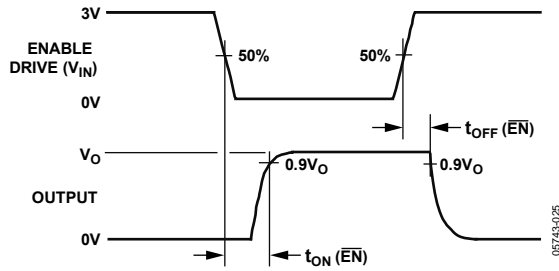

Figure 29. Enable Delay, $t_{ON}(\overline{EN})$, $t_{OFF}(\overline{EN})$

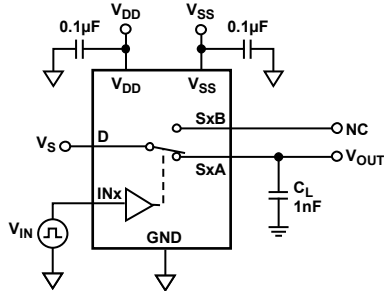

Figure 30. Charge Injection



$$\text{OFF ISOLATION} = 20 \log \frac{V_{OUT}}{V_S}$$

Figure 31. Off Isolation



$$\text{CHANNEL-TO-CHANNEL CROSSTALK} = 20 \log \frac{V_{OUT}}{V_S}$$

Figure 33. Channel-to-Channel Crosstalk



$$\text{INSERTION LOSS} = 20 \log \frac{V_{OUT \text{ WITH SWITCH}}}{V_{OUT \text{ WITHOUT SWITCH}}}$$

Figure 32. Bandwidth



Figure 34. THD + Noise

OUTLINE DIMENSIONS



COMPLIANT TO JEDEC STANDARDS MO-153-AB

Figure 35. 16-Lead Thin Shrink Small Outline Package [TSSOP] (RU-16)

Dimensions shown in millimeters



COMPLIANT TO JEDEC STANDARDS MO-153-AC

Figure 36. 20-Lead Thin Shrink Small Outline Package [TSSOP] (RU-20)

Dimensions shown in millimeters



COMPLIANT TO JEDEC STANDARDS MO-220-WGGC.
 Figure 37. 16-Lead Lead Frame Chip Scale Package [LFCS]
 4 mm × 4 mm Body and 0.75 mm Package Height
 (CP-16-23)
 Dimensions shown in millimeters



COMPLIANT TO JEDEC STANDARDS MO-220-WGGD-1.
 Figure 38. 20-Lead Lead Frame Chip Scale Package [LFCS]
 4 mm × 4 mm Body and 0.75 mm Package Height
 (CP-20-6)
 Dimensions shown in millimeters

ORDERING GUIDE

Model ¹	Temperature Range	Package Description	Package Option
ADG1233YRUZ	-40°C to +125°C	16-Lead Thin Shrink Small Outline Package [TSSOP]	RU-16
ADG1233YRUZ-REEL7	-40°C to +125°C	16-Lead Thin Shrink Small Outline Package [TSSOP]	RU-16
ADG1233YCPZ-REEL7	-40°C to +125°C	16-Lead Lead Frame Chip Scale Package [LFCS]	CP-16-23
ADG1234YRUZ	-40°C to +125°C	20-Lead Thin Shrink Small Outline Package [TSSOP]	RU-20
ADG1234YRUZ-REEL7	-40°C to +125°C	20-Lead Thin Shrink Small Outline Package [TSSOP]	RU-20
ADG1234YCPZ-REEL	-40°C to +125°C	20-Lead Lead Frame Chip Scale Package [LFCS]	CP-20-6
ADG1234YCPZ-REEL7	-40°C to +125°C	20-Lead Lead Frame Chip Scale Package [LFCS]	CP-20-6

¹ Z = RoHS Compliant Part.

Компания «Life Electronics» занимается поставками электронных компонентов импортного и отечественного производства от производителей и со складов крупных дистрибьюторов Европы, Америки и Азии.

С конца 2013 года компания активно расширяет линейку поставок компонентов по направлению коаксиальный кабель, кварцевые генераторы и конденсаторы (керамические, пленочные, электролитические), за счёт заключения дистрибьюторских договоров

Мы предлагаем:

- Конкурентоспособные цены и скидки постоянным клиентам.
- Специальные условия для постоянных клиентов.
- Подбор аналогов.
- Поставку компонентов в любых объемах, удовлетворяющих вашим потребностям.
- Приемлемые сроки поставки, возможна ускоренная поставка.
- Доставку товара в любую точку России и стран СНГ.
- Комплексную поставку.
- Работу по проектам и поставку образцов.
- Формирование склада под заказчика.
- Сертификаты соответствия на поставляемую продукцию (по желанию клиента).
- Тестирование поставляемой продукции.
- Поставку компонентов, требующих военную и космическую приемку.
- Входной контроль качества.
- Наличие сертификата ISO.

В составе нашей компании организован Конструкторский отдел, призванный помогать разработчикам, и инженерам.

Конструкторский отдел помогает осуществить:

- Регистрацию проекта у производителя компонентов.
- Техническую поддержку проекта.
- Защиту от снятия компонента с производства.
- Оценку стоимости проекта по компонентам.
- Изготовление тестовой платы монтаж и пусконаладочные работы.



Тел: +7 (812) 336 43 04 (многоканальный)
Email: org@lifeelectronics.ru