

Broadening the Tektronix Signal Source Portfolio

Cost efficient signal generation



Tektronix[®]

Introducing a Full Featured Bench Top Arbitrary Function Generator for the Value Segment

**Standard
3 year
warranty**



***Proven AFG
Technology for price
sensitive customers!***

**Starting at
\$1,590**

Model	Bandwidth	Channel	Sample rate	Resolution	Interface	MSRP in US
AFG2021	20MHz	1	250MS/s	14bit	USB Host & Device	\$1,590
AFG2021 (with GL option)	20MHz	1	250MS/s	14bit	USB Host & Device, GPIB and LAN	\$1,690

Best-in-class Performance

AFG2000 Series Overview

Performance

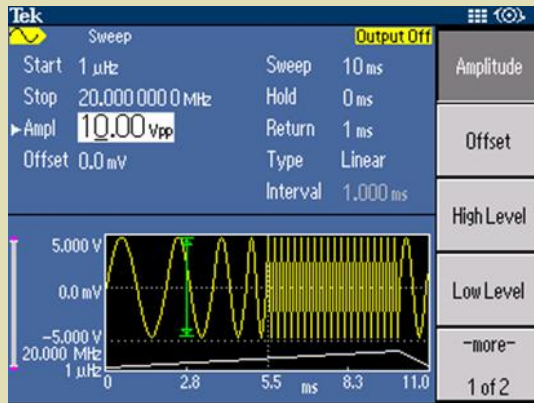

- Leverages industry leading AFG3000 technology & UI
- 1 μ Hz~20MHz sine
- 250MS/s sample rate
- 1ppm stability
- 14bit vertical resolution
- 10Vpp into 50ohm load

Flexibility



- 12 built-in standard waveforms
- 4 distinct run modes
- Built-in noise generator
- Easily share waveform & set-up data with AFG3000 models

Versatility



- Compact form factor
- Optional GPIB and LAN
- Free ArbExpress and SignalExpress productivity software

Superior Features at an Affordable Price

- 20MHz bandwidth
- 14bit vertical resolution
- 250MS/s sample rate
- 12 built-in standard waveforms
- Continues, sweep, modulation and burst modes
- 4 × 128 KS built-in memory and USB memory expansion for user defined waveforms

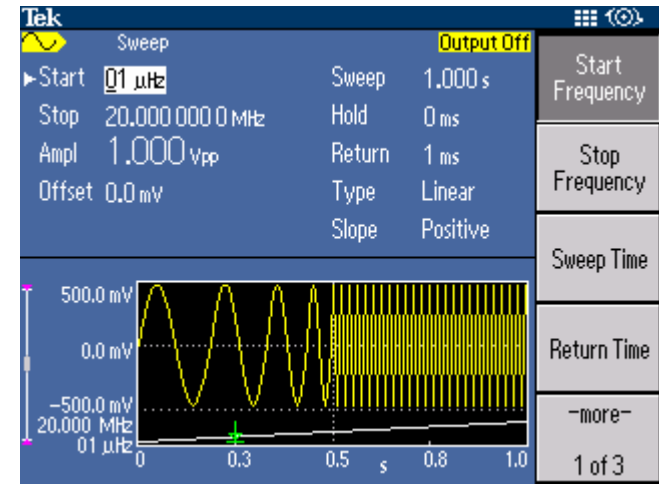

Enabling end user to quickly generate simple or complex waveforms to exercise their designs

Leveraging Proven AFG3000 Technology

- The innovative ease-of-use features first seen on AFG3000 are the building blocks for the AFG2021
 - A 3.5 in color TFT LCD shows the relevant settings in both graphic and text formats
 - The shortcut buttons and rotary knob allow easy access to the most frequently used settings and functions

- Menu and online help are available in 8 languages

- The AFG3000 customers can migrate to AFG2021 quickly without having to learn a new User Interface

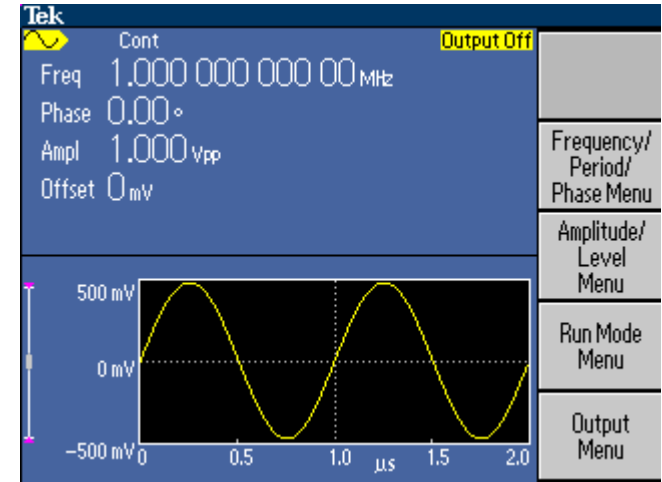

Efficient Shortcuts to High Frequency

- DDS technology enables accurate, easy and on-the-fly changes to frequency and phase characteristics
 - 1uHz to 20MHz sine wave, 1uHz or 12digits frequency resolution
 - $-180^\circ \sim 180^\circ$ phase range, 0.01° resolution
- High stability time base
 - ± 1 ppm internal frequency reference
 - 1ppm per year aging

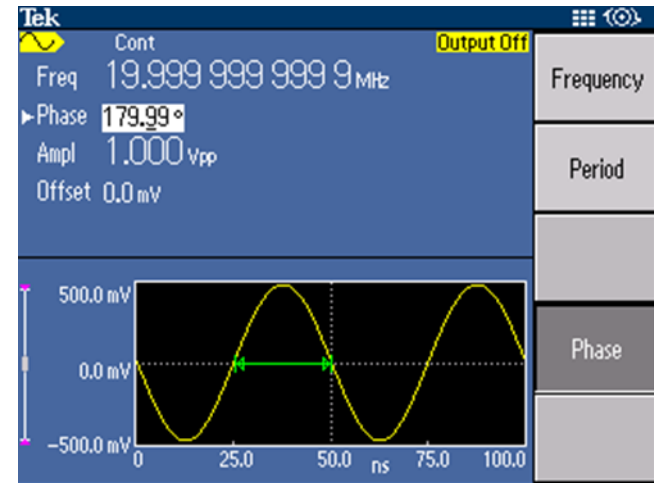

Connectivity

- Standard USB Host and Device, Optional GPIB and LAN
 - Customized waveforms and settings can be saved in USB memory sticks, and recalled for later use, via the front panel USB host socket
 - USB device, GPIB and LAN fulfills the connectivity requirements to download waveforms to the instrument and remote control from a PC

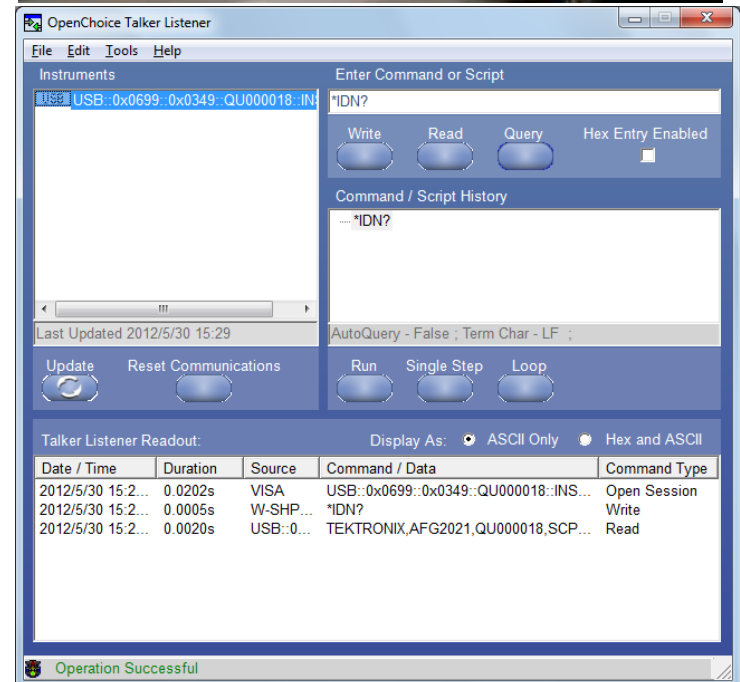

ArbExpress® Real-world Waveform Replication Made Easy

- The ArbExpress waveform editing software ships free with every unit
- Convenient way to create and edit customized waveforms
 - Use standard waveforms as templates
 - Use freehand draw, equation editor or point draw modes
- Compatible to Tek oscilloscopes for direct loading of captured signals onto the host PC
- Download created/captured waveforms to AFG for replication via USB, GPIB or LAN connections.
- Facilitates control the AFG2000 remotely

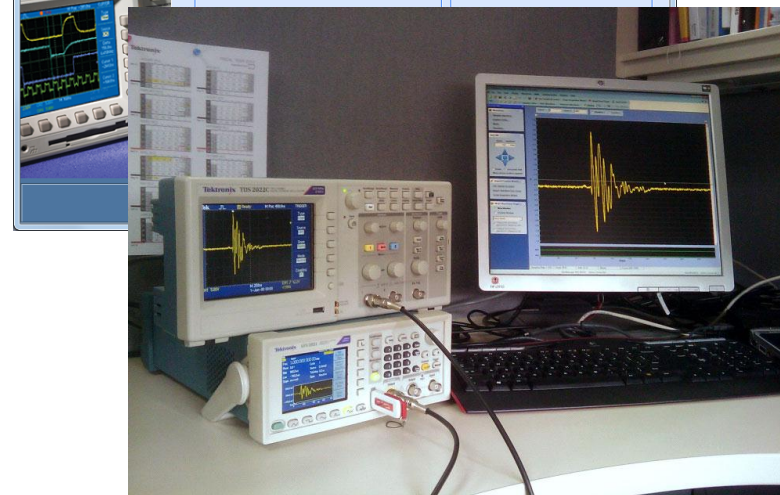
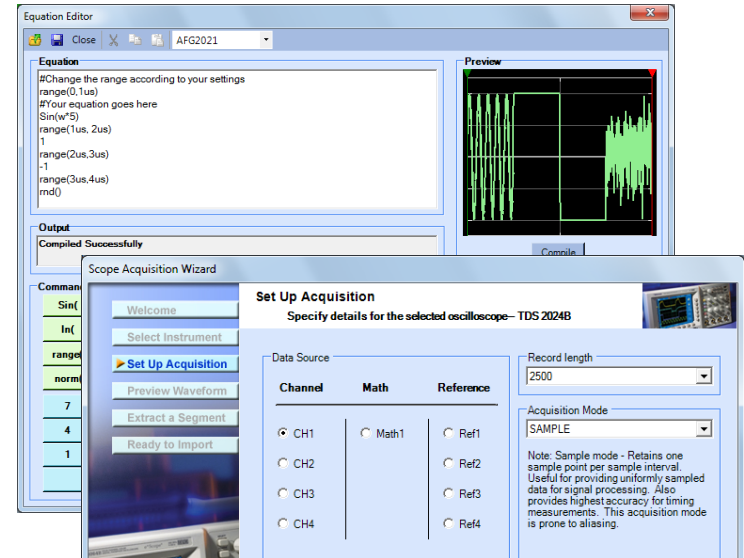

Increase Productivity with SignalExpress

- National Instruments LabView SignalExpress LE version ships free with every unit
- Integrates AFG2021 to the whole Tektronix Bench portfolio
- Intuitive drag-and-drop interface provides an alternative to writing complex software routines
 - Basic instrument control
 - Data logging
 - Data analysis
 - Measurement trending
 - Documentation



Compact Form Factor

- The standard 2U height and half-rack width form factor fits both bench top and rack mount applications
- Stackable
 - Easily stack on other Tektronix bench instruments
 - Save valuable bench top space
- Perfect option for ATE and system integration
 - Available RMU2U rack mount kit simplifies rack mount requirements
 - Full support for GPIB & SCPI command environments

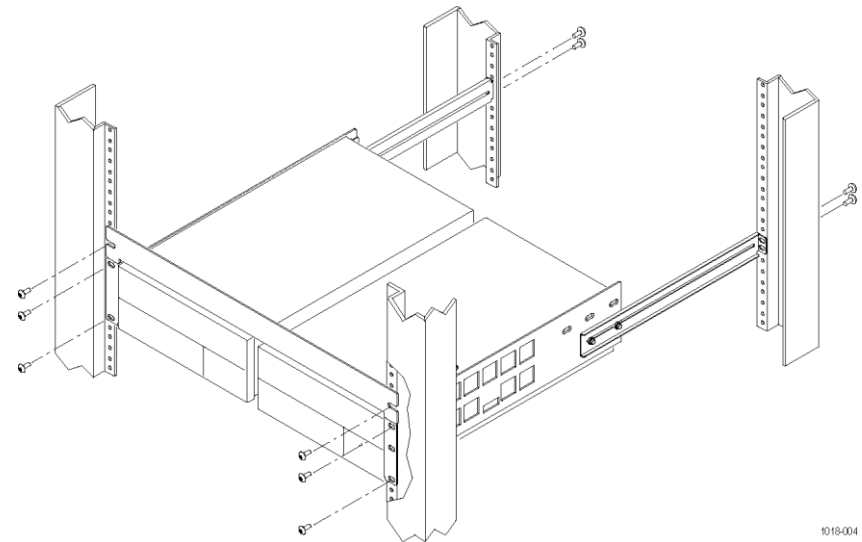
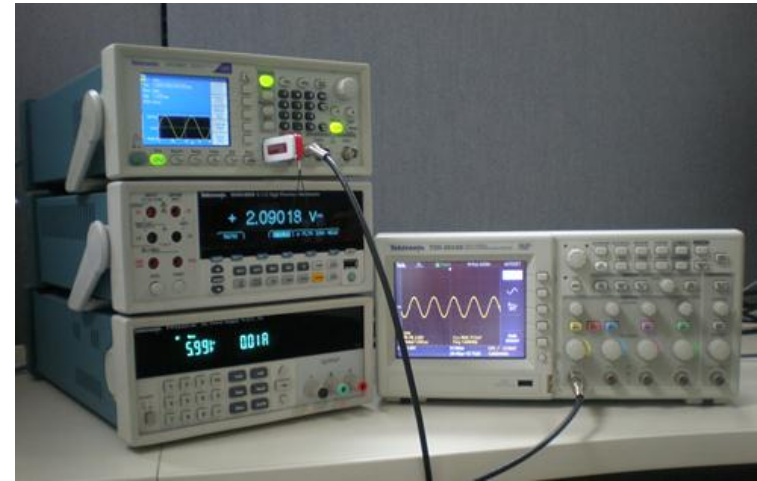

1018-004

Ordering information

■ Base Model Pricing

Product	Description	US\$ Master Price
AFG2021	Arbitrary/Function Generator, 1-ch, 20MHz, 250MS/s, 14bit	\$1,590

■ Configuration Options

Option	Description	US\$ Master Price
GL	GPIB and LAN interfaces	\$100

■ Standard Accessories

Accessory
User Manual
Power Cord
USB Cable
CD-ROM with Programmer manual and service manual
CD-ROM with NI Labview Signal Express and IVI Drivers
CD-ROM with ArbExpress Software
NIST-Traceable Calibration Certificate

■ Recommended Accessories

Item	Description	US MSRP
RMU2U	Rackmount kit	\$152
013-0345-00	Fuse adapter, BNC-P to BNC-R	\$312
159-0454-00	Fuse set, 3 pcs, 0.125 A	\$21
012-0482-00	BNC cable shielded, 3 ft	\$206
012-1256-00	BNC cable shielded, 9 ft	\$84
012-0991-00	GPIB cable, double shielded	\$488
011-0049-02	50Ω BNC Terminator	\$135

Options

■ Power Plug Options

Opt	Description	US MSRP
A0	North America	\$0
A1	Universal Euro	\$0
A2	United Kingdom	\$0
A3	Australia	\$0
A5	Switzerland	\$0
A6	Japan	\$0
A10	China	\$0
A11	India	\$0
A12	Brazil	\$0
A99	No power cord or adapter	\$0

■ Language Options

Opt	Description	US MSRP
L0	English manual	\$0
L1	French manual	\$0
L2	Italian manual	\$0
L3	German manual	\$0
L4	Spanish manual	\$0
L5	Japanese manual	\$0
L6	Portuguese manual	\$0
L7	Simple Chinese manual	\$0
L8	Traditional Chinese manual	\$0
L9	Korean manual	\$0
L10	Russian manual	\$0
L99	No Manual	\$0

■ Service Options

Opt	Description	US MSRP
C3	Calibration service 3 years	\$390
C5	Calibration service 5 years	\$738
D1	Calibration data report	\$65
D3	Calibration data report 3 years (with C3)	\$82
D5	Calibration data report 5 years (with C5)	\$163
R5	Repair service 5 years	\$260
R5DW	Repair Service Coverage 5 Years (starts at time of customer instrument purchase)	\$260

Key Dates

Activity	Date
Order Queue Opens	▪ June 10, 2012
Shipments Begin	▪ July 03, 2012
Public Announcement *	▪ August 07, 2012

* Product availability: target is 4 weeks.

Demos & Training

- Demo Units
 - Distribution channel partners can opt to utilize the AFG2000 as demo for the entire AFG family
- Training
 - Level 1 CDT training and a demo guide will be developed as part of the product launch and will be made available through the Partner net

Demand Generation and Marketing Collateral



Customer Presentation

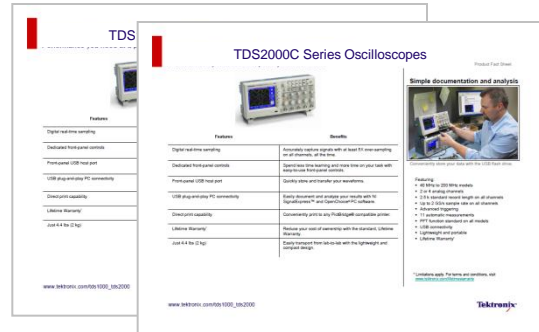

Product Fact Sheets



Product Material Q3



Web Content

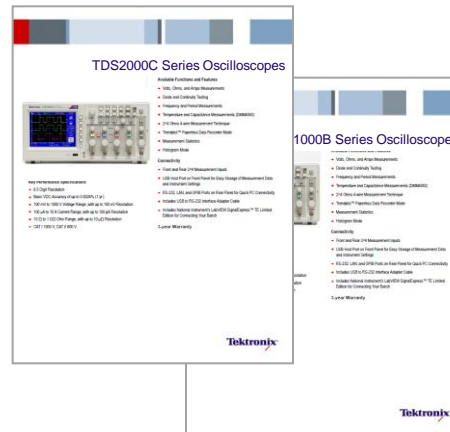

Product Datasheets



Application Notes Q3

Front panel

On-line help in 8 languages

Save/recall settings to/from internal or USB memory

Rotary knob and key pad provide two ways to change numeric settings

Trigger Input / Output and Manual Trigger ease the effort for multi-instrument synchronization

USB Host on Front panel for waveform and setting save/recall

Floating output up to 42Vpk

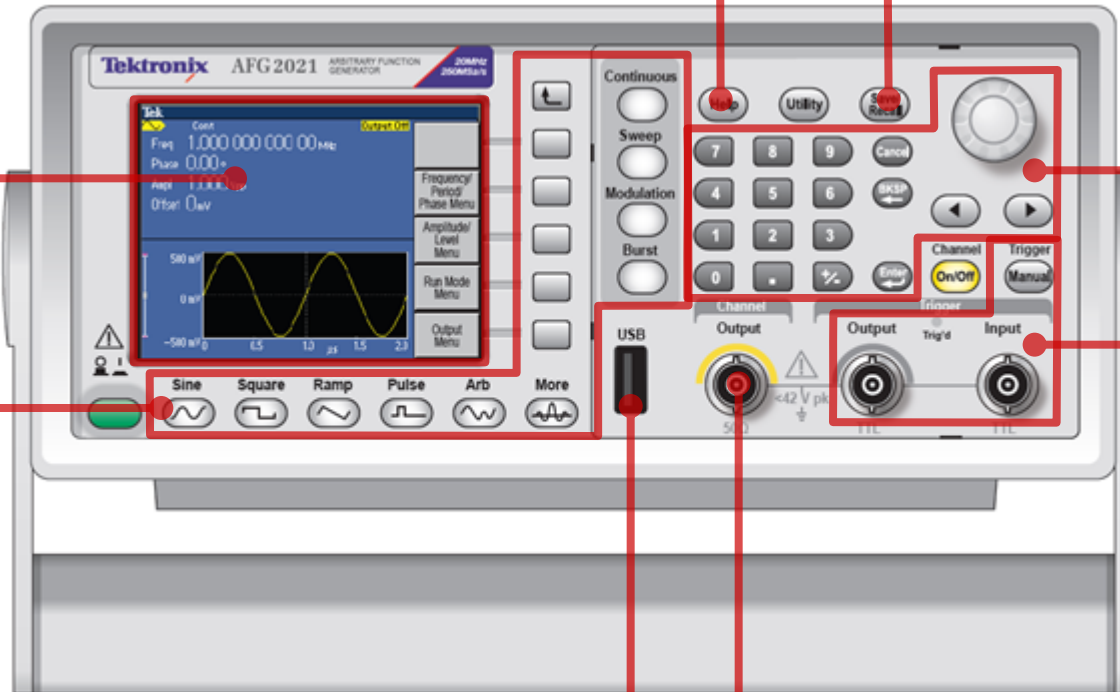

3.5" Color TFT LCD Displays waveform and settings in text and graphic

Shortcut buttons for easy access to frequently used functions and settings

Rear panel

- Rear panel of base model



- Rear panel of model with GL option



External Modulating Signal Input External Reference Clock Input

GPIB (optional)

USB Device (optional) Ethernet LAN 10/100 M

Компания «Life Electronics» занимается поставками электронных компонентов импортного и отечественного производства от производителей и со складов крупных дистрибьюторов Европы, Америки и Азии.

С конца 2013 года компания активно расширяет линейку поставок компонентов по направлению коаксиальный кабель, кварцевые генераторы и конденсаторы (керамические, пленочные, электролитические), за счёт заключения дистрибьюторских договоров

Мы предлагаем:

- Конкуренспособные цены и скидки постоянным клиентам.
- Специальные условия для постоянных клиентов.
- Подбор аналогов.
- Поставку компонентов в любых объемах, удовлетворяющих вашим потребностям.
- Приемлемые сроки поставки, возможна ускоренная поставка.
- Доставку товара в любую точку России и стран СНГ.
- Комплексную поставку.
- Работу по проектам и поставку образцов.
- Формирование склада под заказчика.
- Сертификаты соответствия на поставляемую продукцию (по желанию клиента).
- Тестирование поставляемой продукции.
- Поставку компонентов, требующих военную и космическую приемку.
- Входной контроль качества.
- Наличие сертификата ISO.

В составе нашей компании организован Конструкторский отдел, призванный помогать разработчикам, и инженерам.

Конструкторский отдел помогает осуществить:

- Регистрацию проекта у производителя компонентов.
- Техническую поддержку проекта.
- Защиту от снятия компонента с производства.
- Оценку стоимости проекта по компонентам.
- Изготовление тестовой платы монтаж и пусконаладочные работы.



Тел: +7 (812) 336 43 04 (многоканальный)
Email: org@lifeelectronics.ru