

FEATURES

- **LTC1321: 2-EIA562/RS232 Transceivers/2-RS485 Transceivers**
- **LTC1322: 4-EIA562/RS232 Transceivers/2-RS485 Transceivers**
- **LTC1335: 4-EIA562 Transceivers/2-RS485 Transceivers with OE**
- LTC1321/LTC1322 Have the Same Pinout as SP301/SP302
- LTC1335 Features Receiver Three-State Outputs
- Low Supply Current: **1mA Typical**
- 15 μ A Supply Current in Shutdown
- 120kBaud in EIA/TIA-562 or RS232 Mode
- 10MBaud in RS485/RS422 Mode
- Self-Testing Capability in Loopback Mode
- Power-Up/Down Glitch-Free Outputs
- Driver Maintains High Impedance in Three-State, Shutdown or With Power Off
- Thermal Shutdown Protection
- I/O Lines Can Withstand ± 25 V
- Withstands Repeated 10kV ESD Pulses

APPLICATIONS

- Low Power RS485/RS422/EIA562/RS232 Interface
- Cable Repeater
- Level Translator

DESCRIPTION

The LTC1321/LTC1322/LTC1335 are low power CMOS bidirectional transceivers, each featuring two reconfigurable interface ports. Each can be configured as two RS485 differential ports, as two single-ended ports, or as one RS485 differential port and one single-ended port. The LTC1321/LTC1322 can provide RS232 or EIA562 compatible single-ended outputs; the LTC1335 provides EIA562 compatible outputs and additionally includes an output enable pin, allowing the receiver logic level outputs to be three-stated.

The RS232/EIA562 transceivers operate to 120kbaud and are in full compliance with EIA/TIA-562 specification. The RS485 transceivers operate to 10Mbaud and are in full compliance with RS485 and RS422 specifications. All interface drivers feature short-circuit and thermal shutdown protection. An enable pin allows RS485 driver outputs to be forced into high impedance which is maintained even when the outputs are forced beyond supply rails or power is off. Both driver outputs and receiver inputs feature ± 10 kV ESD protection. A loopback mode connects the driver outputs back to the receiver inputs for diagnostic self-test.

The LTC1321/LTC1322 can support RS232 voltage levels when $6.5\text{V} \leq V_{DD} \leq 10\text{V}$ and $-6.5\text{V} \geq V_{EE} \geq -10\text{V}$. The LTC1335 supports receiver output enable but not RS232 levels. A shutdown mode reduces the I_{CC} supply current to 15 μ A.

TYPICAL APPLICATION

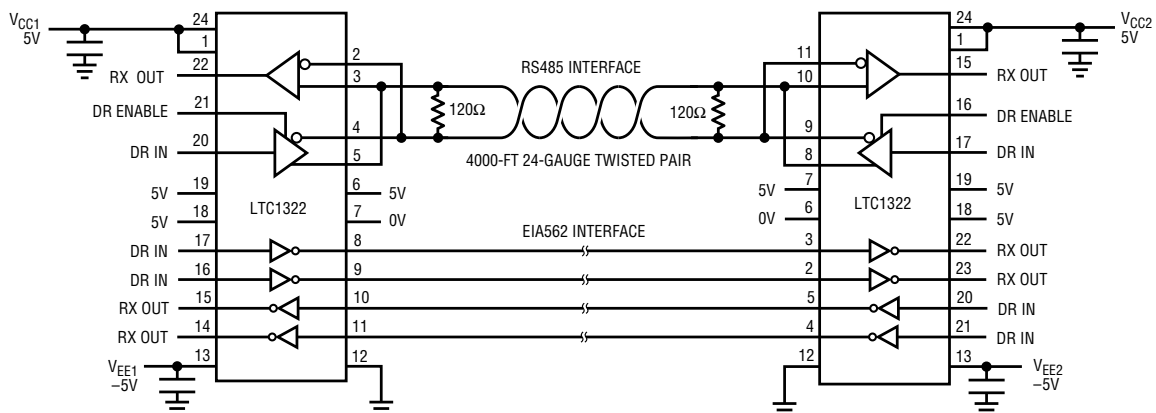

1321/22/35 TA01

LTC1321/LTC1322/LTC1335

ABSOLUTE MAXIMUM RATINGS

Supply Voltage

V_{CC}	6.5V
V_{DD} (LTC1321/LTC1322 Only)	10V
V_{EE}	-10V

Input Voltage

Drivers	-0.3V to ($V_{CC} + 0.3V$)
Receivers	-25V to 25V
ON/OFF, \overline{LB} , SEL1, SEL2, \overline{OE}	-0.3V to ($V_{CC} + 0.3V$)

Output Voltage

Drivers	-25V to 25V
Receivers	-0.3V to ($V_{CC} + 0.3V$)
Output Short-Circuit Duration	Indefinite
Operating Temperature Range	
LTC1321C/LTC1322C/LTC1335C	0°C to 70°C
LTC1321I/LTC1322I/LTC1335I	-40°C to 85°C
Storage Temperature Range	-65°C to 150°C
Lead Temperature (Soldering, 10 sec)	300°C

PACKAGE/ORDER INFORMATION

2 RS485 DRIVERS/RECEIVERS 2 EIA/TIA-562 DRIVERS/RECEIVERS	2 RS485 DRIVERS/RECEIVERS 4 EIA/TIA-562 DRIVERS/RECEIVERS	2 RS485 DRIVERS/RECEIVERS 4 EIA/TIA-562 DRIVERS/RECEIVERS
<p>TOP VIEW</p> <p>N PACKAGE 24-LEAD PLASTIC DIP</p> <p>S PACKAGE 24-LEAD PLASTIC SOL</p> <p>$T_{JMAX} = 125^{\circ}C, \theta_{JA} = 75^{\circ}C/W$ (N) $T_{JMAX} = 125^{\circ}C, \theta_{JA} = 85^{\circ}C/W$ (S)</p>	<p>TOP VIEW</p> <p>N PACKAGE 24-LEAD PLASTIC DIP</p> <p>S PACKAGE 24-LEAD PLASTIC SOL</p> <p>$T_{JMAX} = 125^{\circ}C, \theta_{JA} = 75^{\circ}C/W$ (N) $T_{JMAX} = 125^{\circ}C, \theta_{JA} = 85^{\circ}C/W$ (S)</p>	<p>TOP VIEW</p> <p>N PACKAGE 24-LEAD PLASTIC DIP</p> <p>S PACKAGE 24-LEAD PLASTIC SOL</p> <p>$T_{JMAX} = 125^{\circ}C, \theta_{JA} = 75^{\circ}C/W$ (N) $T_{JMAX} = 125^{\circ}C, \theta_{JA} = 85^{\circ}C/W$ (S)</p>
ORDER PART NUMBER	ORDER PART NUMBER	ORDER PART NUMBER
LTC1321CN LTC1321CS LTC1321IN LTC1321IS	LTC1322CN LTC1322CS LTC1322IN LTC1322IS	LTC1335CN LTC1335CS LTC1335IN LTC1335IS

Consult factory for Military grade parts.

DC ELECTRICAL CHARACTERISTICS $V_{CC} = V_{DD}$ (LTC1321/LTC1322) = 5V \pm 5%, $V_{EE} = -5V \pm$ 5% (Notes 2, 3)

SYMBOL	PARAMETER	CONDITIONS	MIN	TYP	MAX	UNITS	
RS485 Driver (SEL1 = SEL2 = HIGH)							
V_{OD1}	Differential Driver Output Voltage (Unloaded)	$I_O = 0$	●		5	V	
V_{OD2}	Differential Driver Output Voltage (With Load)	Figure 1, R = 50 Ω (RS422) Figure 1, R = 27 Ω (RS485)	● ●	2.0 1.5	5 5	V V	
ΔV_{OD}	Change in Magnitude of Driver Differential Output Voltage for Complementary Output States	Figure 1, R = 27 Ω or R = 50 Ω	●		0.2	V	
V_{OC}	Driver Common-Mode Output Voltage	Figure 1, R = 27 Ω or R = 50 Ω	●		3	V	
$\Delta V_{OC} $	Change in Magnitude of Driver Common-Mode Output Voltage for Complementary Output States	Figure 1, R = 27 Ω or R = 50 Ω	●		0.2	V	
I_{OSD}	Driver Short-Circuit Current	$-7V \leq V_O \leq 12V$, $V_O = \text{HIGH}$ $-7V \leq V_O \leq 12V$, $V_O = \text{LOW}$ (Note 4)	● ●	35 10	250 250	mA mA	
I_{OZD}	Three-State Output Current (Y, Z)	$-7V \leq V_O \leq 12V$	●	± 5	± 500	μA	
EIA/TIA-562 Driver (SEL1 = SEL2 = LOW)							
V_O	Output Voltage Swing	Figure 4, $R_L = 3k$, Positive Figure 4, $R_L = 3k$, Negative	● ●	3.7 -3.7	4.2 -4.3	V V	
I_{OSD}	Output Short-Circuit Current	$V_O = 0V$	●	± 11	± 60	mA	
Driver Inputs and Control Inputs							
V_{IH}	Input High Voltage	D, DE, ON/OFF, SEL1, SEL2, $\overline{\text{LB}}$ OE (LTC1335)	● ●	2 2		V V	
V_{IL}	Input Low Voltage	D, DE, ON/OFF, SEL1, SEL2, $\overline{\text{LB}}$ OE (LTC1335)	● ●		0.8 0.8	V V	
I_{IN}	Input Current	D, SEL1, SEL2 DE, ON/OFF, LB OE (LTC1335)	● ● ●		± 10 -4 -15 4 15	μA μA μA	
RS485 Receiver (SEL1 = SEL2 = HIGH)							
V_{TH}	Differential Input Threshold Voltage	$-7V \leq V_{CM} \leq 7V$, Commercial $-7V \leq V_{CM} \leq 7V$, Industrial	● ●	-0.2 -0.3	0.2 0.3	V V	
ΔV_{TH}	Input Hysteresis	$V_{CM} = 0V$	●	70		mV	
I_{IN}	Input Current (A, B)	$-7V \leq V_{IN} \leq 12V$	●		± 1	mA	
R_{IN}	Input Resistance	$-7V \leq V_{IN} \leq 12V$	●	12	24	k Ω	
EIA/TIA-562 Receiver (SEL1 = SEL2 = LOW)							
V_{TH}	Receiver Input Voltage Threshold	Input Low Threshold Input High Threshold	● ●	0.8 1.1 1.7	2.4	V V	
ΔV_{TH}	Receiver Input Hysteresis		●	0.1	0.6	1.0	V
R_{IN}	Receiver Input Resistance	$V_{IN} = \pm 10V$		3	5	7	k Ω
Receiver Output							
V_{OH}	Receiver Output High Voltage	$I_O = -3\text{mA}$, $V_{IN} = 0V$, SEL1 = SEL2 = LOW	●	3.5	4.6	V	
V_{OL}	Receiver Output Low Voltage	$I_O = 3\text{mA}$, $V_{IN} = 3V$, SEL1 = SEL2 = LOW	●		0.2	0.4	V
I_{OSR}	Short-Circuit Current	$0V \leq V_O \leq V_{CC}$	●	7	85	mA	
I_{OZR}	Three-State Output Current	ON/OFF = 0V OE = V_{CC} (LTC1335)	● ●		± 10 ± 10	μA μA	

DC ELECTRICAL CHARACTERISTICS

$V_{CC} = V_{DD}$ (LTC1321/LTC1322) = 5V ±5%, $V_{EE} = -5V$ ±5% (Notes 2, 3)

SYMBOL	PARAMETER	CONDITIONS	MIN	TYP	MAX	UNITS
Supply Currents						
I_{CC}	V_{CC} Supply Current	No Load (SEL1 = SEL2 = HIGH) Shutdown, ON/OFF = 0V	● ●	1000 15	2000 50	μA μA
I_{DD}	V_{DD} Supply Current (LTC1321/LTC1322)	No Load (SEL1 = SEL2 = LOW) Shutdown, ON/OFF = 0V	● ●	300 0.1	1000 50	μA μA
I_{EE}	V_{EE} Supply Current	No Load (SEL1 = SEL2 = HIGH) Shutdown, ON/OFF = 0V	● ●	-1000 -0.1	-2000 -50	μA μA

AC ELECTRICAL CHARACTERISTICS

$V_{CC} = V_{DD}$ (LTC1321/LTC1322) = 5V ±5%, $V_{EE} = -5V$ ±5% (Notes 2, 3)

SYMBOL	PARAMETER	CONDITIONS	MIN	TYP	MAX	UNITS	
EIA/TIA-562 Mode (SEL1 = SEL2 = LOW)							
SR	Slew Rate	Figure 4, $R_L = 3k$, $C_L = 15pF$ Figure 4, $R_L = 3k$, $C_L = 1000pF$	● ●	14 7	30	V/μs V/μs	
t_T	Transition Time	Figure 4, $R_L = 3k$, $C_L = 2500pF$	●	0.22	1.9	3.1	μs
t_{PLH}	Driver Input to Output	Figures 4,10, $R_L = 3k$, $C_L = 15pF$	●		0.6	4	μs
t_{PHL}	Driver Input to Output	Figures 4,10, $R_L = 3k$, $C_L = 15pF$	●		0.6	4	μs
t_{PLH}	Receiver Input to Output	Figures 5,11	●		0.3	6	μs
t_{PHL}	Receiver Input to Output	Figures 5,11	●		0.4	6	μs
RS485 Mode (SEL1 = SEL2 = HIGH)							
t_{PLH}	Driver Input to Output	Figures 2,7, $R_L = 54\Omega$, $C_L = 100pF$	●	20	40	70	ns
t_{PHL}	Driver Input to Output	Figures 2,7, $R_L = 54\Omega$, $C_L = 100pF$	●	20	40	70	ns
t_{SKEW}	Driver Output to Output	Figures 2,7, $R_L = 54\Omega$, $C_L = 100pF$	●		5	15	ns
t_r, t_f	Driver Rise or Fall Time	Figures 2,7, $R_L = 54\Omega$, $C_L = 100pF$	●	3	15	40	ns
t_{ZL}	Driver Enable to Output Low	Figures 3,8, $C_L = 100pF$, S1 Closed	●		50	90	ns
t_{ZH}	Driver Enable to Output High	Figures 3,8, $C_L = 100pF$, S2 Closed	●		50	90	ns
t_{LZ}	Driver Disable from Low	Figures 3,8, $C_L = 15pF$, S1 Closed	●		50	90	ns
t_{HZ}	Driver Disable from High	Figures 3,8, $C_L = 15pF$, S2 Closed	●		60	90	ns
t_{PLH}	Receiver Input to Output	Figures 2,9, $R_L = 54\Omega$, $C_L = 100pF$	●	20	60	140	ns
t_{PHL}	Receiver Input to Output	Figures 2,9, $R_L = 54\Omega$, $C_L = 100pF$	●	20	70	140	ns
t_{SKEW}	Differential Receiver Skew, $ t_{PLH} - t_{PHL} $	Figures 2,9, $R_L = 54\Omega$, $C_L = 100pF$	●		10		ns
Receiver Output Enable/Disable (LTC1335)							
t_{ZL}	Receiver Enable to Output Low	Figures 6,12, $C_L = 15pF$, S1 Closed	●		40	90	ns
t_{ZH}	Receiver Enable to Output High	Figures 6,12, $C_L = 15pF$, S2 Closed	●		40	90	ns
t_{LZ}	Receiver Disable from Low	Figures 6,12, $C_L = 15pF$, S1 Closed	●		40	90	ns
t_{HZ}	Receiver Disable from High	Figures 6,12, $C_L = 15pF$, S2 Closed	●		50	90	ns

The ● denotes specifications which apply over the full operating temperature range.

Note 1: Absolute maximum ratings are those values beyond which the safety of the device cannot be guaranteed.

Note 2: All currents into device pins are positive; all currents out of device pins are negative. All voltages are referenced to device ground unless otherwise specified.

Note 3: All typicals are given at $V_{CC} = V_{DD}$ (LTC1321/LTC1322) = 5V, $V_{EE} = -5V$, and $T_A = 25^\circ C$.

Note 4: Short-circuit current for RS485 driver output low state folds back above V_{CC} . Peak current occurs around $V_O = 3V$.

TYPICAL PERFORMANCE CHARACTERISTICS

RS485 Driver Differential Output Voltage vs Temperature



1321 G01

RS485 Driver Differential Output Current vs Output Voltage

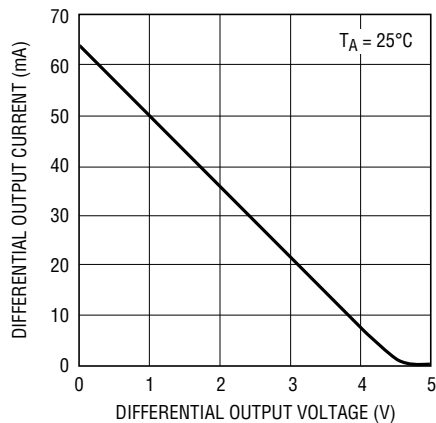

1321 G02

RS485 Driver Skew vs Temperature

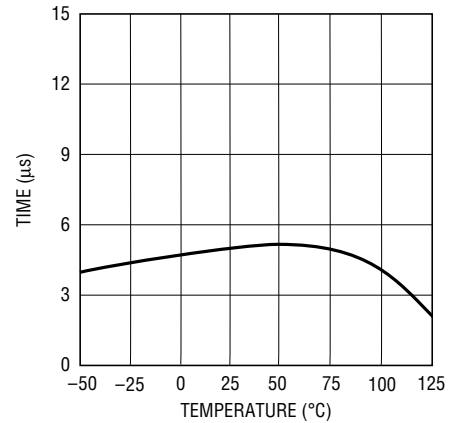

1321 G03

RS485 Driver Output High Voltage vs Output Current

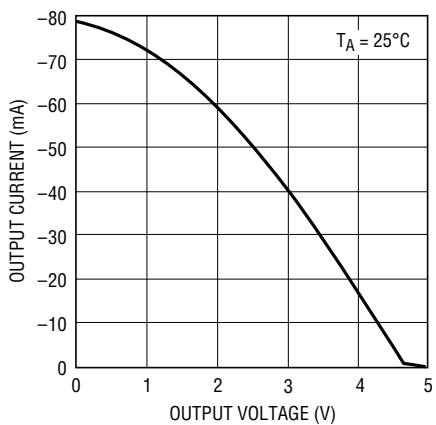

1321 G04

RS485 Driver Output Low Voltage vs Output Current

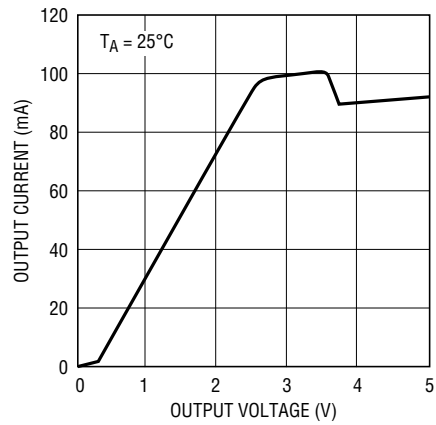

1321 G05

RS485 Driver Output Short-Circuit Current vs Temperature

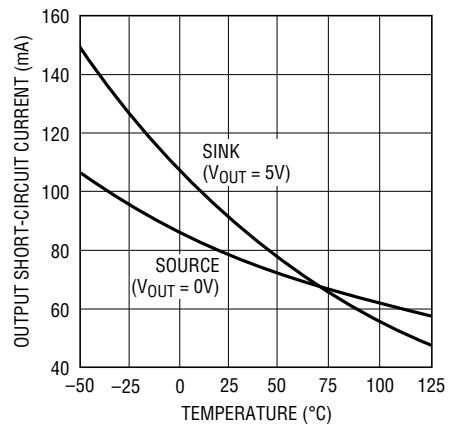

1321 G19

EIA562 Driver Output Voltage vs Temperature

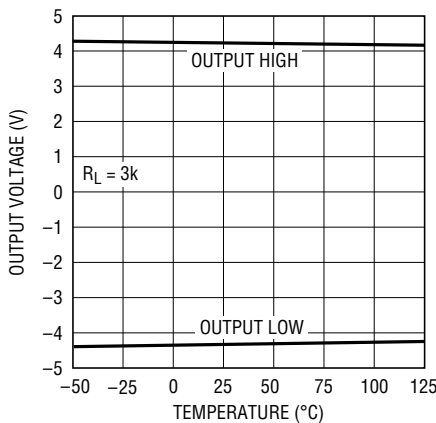

1321 G07

EIA562 Driver Output Voltage vs Supply Voltage

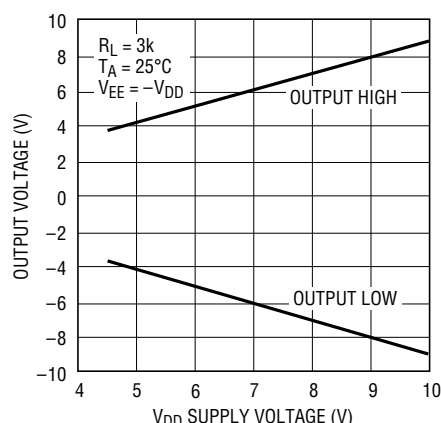

1321 G08

EIA562 Driver Output Short-Circuit Current vs Temperature

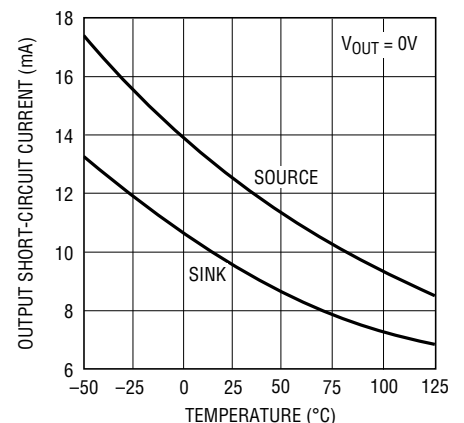

1321 G09

TYPICAL PERFORMANCE CHARACTERISTICS

Receiver Output High Voltage vs Temperature

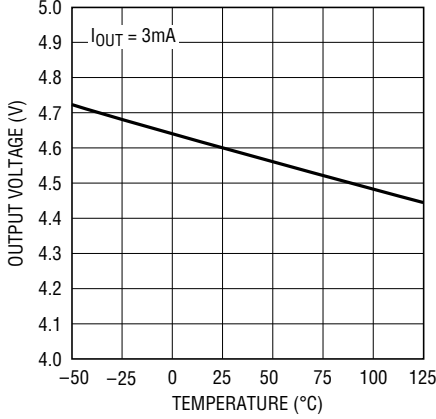

1321 G10

Receiver Output Low Voltage vs Temperature

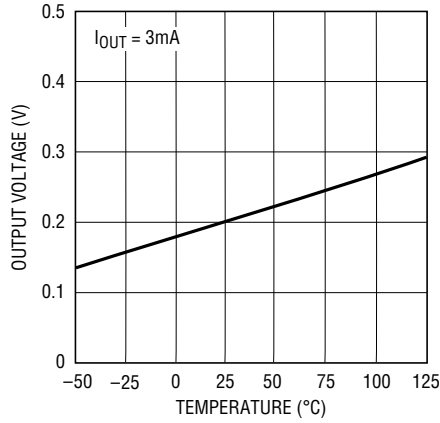

1321 G11

RS485 Receiver |t_{PLH} - t_{PHL}| vs Temperature

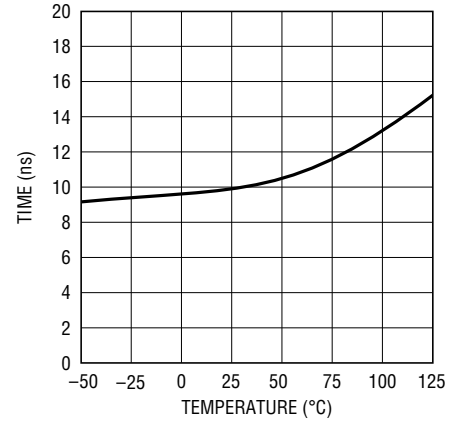

1321 G12

Receiver Output Current vs Output High Voltage



1321 G13

Receiver Output Current vs Output Low Voltage



1321 G14

EIA562 Receiver Input Threshold Voltage vs Temperature

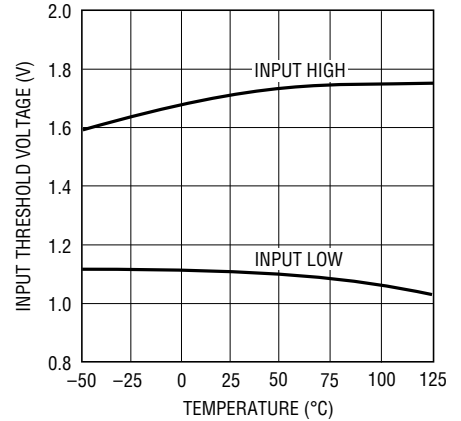

1321 G15

Driver Output Leakage Current (Disable/Shutdown) vs Temperature



1321 G06

Supply Current in RS485 Mode vs Temperature (Both Ports)



1321 G17

Supply Current in EIA562 Mode vs Temperature (Both Ports)

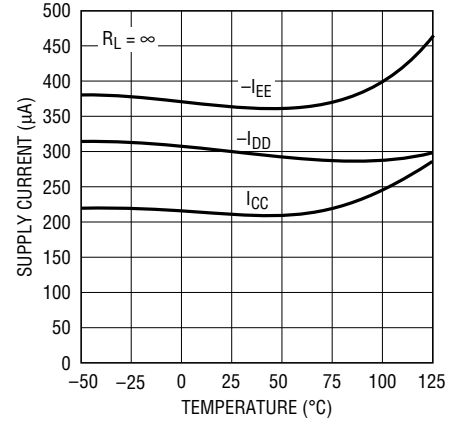

1321 G18

PIN FUNCTIONS

LTC1321

V_{DD} (Pin 1): Positive Supply Input for EIA/TIA-562 Drivers.

B1 (Pin 2): Receiver Input.

A1 (Pin 3): Receiver Input.

Z1 (Pin 4): Driver Output.

Y1 (Pin 5): Driver Output.

SEL1 (Pin 6): Interface Mode Select Input.

SEL2 (Pin 7): Interface Mode Select Input.

Y2 (Pin 8): Driver Output.

Z2 (Pin 9): Driver Output.

A2 (Pin 10): Receiver Input.

B2 (Pin 11): Receiver Input.

GND (Pin 12): Ground.

V_{EE} (Pin 13): Negative Supply.

NC (Pin 14): No Connection.

R_{A2} (Pin 15): Receiver Output.

DE2 (Pin 16): Driver Enable with Internal Pull-Up in RS485 Mode.

D_{Y2} (Pin 17): Driver Input.

ON/OFF (Pin 18): A HIGH logic input enables the transceivers. A LOW puts the device into shutdown mode and reduces I_{CC} to 15μA. This pin has an internal pull-up.

LB (Pin 19): Loopback Control Input. A LOW logic level enables loopback connections. This pin has an internal pull-up.

D_{Y1} (Pin 20): Driver Input.

DE1 (Pin 21): Driver Enable with Internal Pull-Up in RS485 Mode.

R_{A1} (Pin 22): Receiver Output.

NC (Pin 23): No Connection.

V_{CC} (Pin 24): Positive Supply; $4.75V \leq V_{CC} \leq 5.25V$.

LTC1322/LTC1335

OE/V_{DD} (Pin 1): For LTC1335, pin 1 is the receiver output enable with internal pull-down. For LTC1322, pin 1 is the positive supply input for EIA/TIA-562 drivers.

B1 (Pin 2): Receiver Input.

A1 (Pin 3): Receiver Input.

Z1 (Pin 4): Driver Output.

Y1 (Pin 5): Driver Output.

SEL1 (Pin 6): Interface Mode Select Input.

SEL2 (Pin 7): Interface Mode Select Input.

Y2 (Pin 8): Driver Output.

Z2 (Pin 9): Driver Output.

A2 (Pin 10): Receiver Input.

B2 (Pin 11): Receiver Input.

GND (Pin 12): Ground.

V_{EE} (Pin 13): Negative Supply.

R_{B2} (Pin 14): Receiver Output.

R_{A2} (Pin 15): Receiver Output.

D_{Z2}/DE2 (Pin 16): EIA/TIA-562 Driver Input in EIA562 Mode. RS485 Driver Enable with Internal Pull-Up in RS485 Mode.

D_{Y2} (Pin 17): Driver Input.

ON/OFF (Pin 18): A HIGH logic input enables the transceivers. A LOW puts the device into shutdown mode and reduces I_{CC} to 15μA. This pin has an internal pull-up.

LB (Pin 19): Loopback Control Input. A LOW logic level enables loopback connections. This pin has an internal pull-up.

D_{Y1} (Pin 20): Driver Input.

D_{Z1}/DE1 (Pin 21): EIA/TIA-562 Driver Input in EIA562 Mode. RS485 Driver Enable with Internal Pull-Up in RS485 Mode.

R_{A1} (Pin 22): Receiver Output.

R_{B1} (Pin 23): Receiver Output.

V_{CC} (Pin 24): Positive Supply; $4.75V \leq V_{CC} \leq 5.25V$.

FUNCTION TABLES

LTC1321

RS485 Driver Mode

INPUTS				LINE CONDITION	OUTPUTS	
ON/OFF	SEL	DE	D		Y	Z
1	1	1	0	No Fault	0	1
1	1	1	1	No Fault	1	0
1	1	1	X	Fault	Z	Z
1	1	0	X	X	Z	Z
0	1	X	X	X	Z	Z

RS485 Receiver Mode

INPUTS			OUTPUT R
ON/OFF	SEL	A – B	
1	1	< -0.2V	0
1	1	> 0.2V	1
1	1	Inputs Open	1
0	1	X	Z

RS232/EIA562 Driver Mode

INPUTS			LINE CONDITION	OUTPUT Y
ON/OFF	SEL	D		
1	0	0	No Fault	1
1	0	1	No Fault	0
1	0	X	Fault	Z
0	0	X	X	Z

RS232/EIA562 Receiver Mode

INPUTS			OUTPUT R
ON/OFF	SEL	A	
1	0	0	1
1	0	1	0
1	0	Inputs Open	1
0	0	X	Z

LTC1322

RS485 Driver Mode

INPUTS				LINE CONDITION	OUTPUTS	
ON/OFF	SEL	DE	D		Y	Z
1	1	1	0	No Fault	0	1
1	1	1	1	No Fault	1	0
1	1	1	X	Fault	Z	Z
1	1	0	X	X	Z	Z
0	1	X	X	X	Z	Z

RS485 Receiver Mode

INPUTS			OUTPUT R
ON/OFF	SEL	A – B	
1	1	< -0.2V	0
1	1	> 0.2V	1
1	1	Inputs Open	1
0	1	X	Z

RS232/EIA562 Driver Mode

INPUTS			LINE CONDITION	OUTPUT Y, Z
ON/OFF	SEL	D		
1	0	0	No Fault	1
1	0	1	No Fault	0
1	0	X	Fault	Z
0	0	X	X	Z

RS232/EIA562 Receiver Mode

INPUTS			OUTPUT R
ON/OFF	SEL	A OR B	
1	0	0	1
1	0	1	0
1	0	Input Open	1
0	0	X	Z

FUNCTION TABLES

LTC1335

RS485 Driver Mode

INPUTS				LINE CONDITION	OUTPUTS	
ON/OFF	SEL	DE	D		Y	Z
1	1	1	0	No Fault	0	1
1	1	1	1	No Fault	1	0
1	1	1	X	Fault	Z	Z
1	1	0	X	X	Z	Z
0	1	X	X	X	Z	Z

RS485 Receiver Mode

INPUTS				OUTPUT R
ON/OFF	SEL	OE	A - B	
1	1	0	< -0.2V	0
1	1	0	> 0.2V	1
1	1	0	Inputs Open	1
1	1	1	X	Z
0	1	X	X	Z

EIA562 Driver Mode

INPUTS			LINE CONDITION	OUTPUT Y, Z
ON/OFF	SEL	D		
1	0	0	No Fault	1
1	0	1	No Fault	0
1	0	X	Fault	Z
0	0	X	X	Z

EIA562 Receiver Mode

INPUTS				OUTPUT R
ON/OFF	SEL	OE	A OR B	
1	0	0	0	1
1	0	0	1	0
1	0	0	Input Open	1
1	0	1	X	Z
0	0	X	X	Z

BLOCK DIAGRAMS

LTC1321 Interface Configuration Without Loopback



* SEL1/SEL2 = VCC

1321BD01

BLOCK DIAGRAMS

LTC1321 Interface Configuration With Loopback



LTC1322/LTC1335 Interface Configuration Without Loopback



* FOR LTC1322 ONLY, PIN 1 IS V_{DD}, AND OE IS ALWAYS ENABLED.
FOR LTC1335, PIN 1 IS OE, AND V_{DD} IS CONNECTED TO V_{CC}.

** SEL1/SEL2 = V_{CC}.

BLOCK DIAGRAMS

LTC1322/LTC1335 Interface Configuration With Loopback



* FOR LTC1322 ONLY, PIN 1 IS V_{DD} , AND \overline{OE} IS ALWAYS ENABLED.
 FOR LTC1335, PIN 1 IS \overline{OE} , AND V_{DD} IS CONNECTED TO V_{CC} .

**SEL1/SEL2 = V_{CC} .

1322/35 B002

TEST CIRCUITS

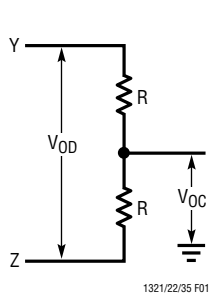

Figure 1. RS485 Driver Test Load

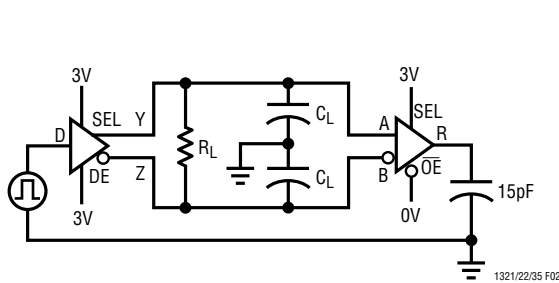

Figure 2. RS485 Driver/Receiver Timing Test Circuit

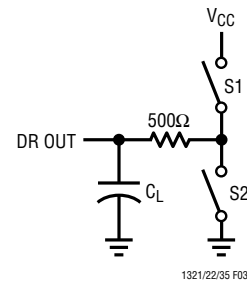

Figure 3. RS485 Driver Output Enable/Disable Timing Test Load

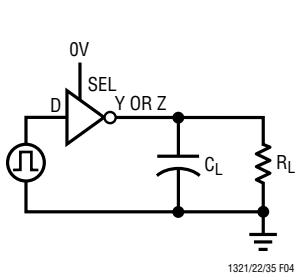

Figure 4. EIA/TIA-562 Driver Timing Test Circuit

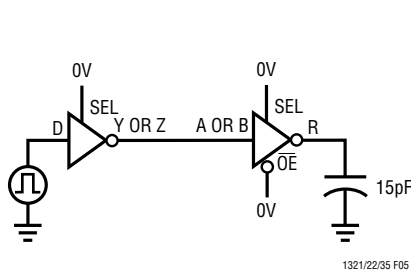

Figure 5. EIA/TIA-562 Receiver Timing Test Circuit

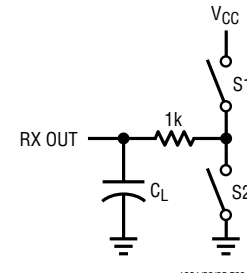

Figure 6. Receiver Output Enable/Disable Timing Test Load

SWITCHING WAVEFORMS



Figure 7. RS485 Driver Propagation Delays



Figure 8. RS485 Driver Enable and Disable Times



Figure 9. RS485 Receiver Propagation Delays

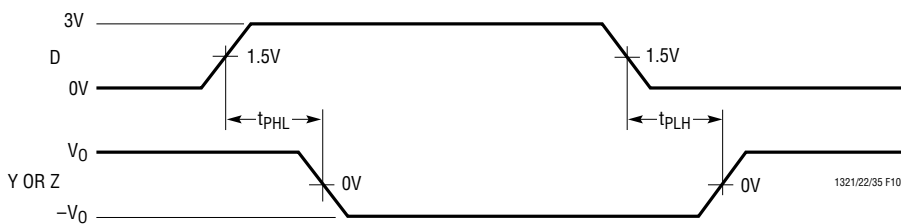

Figure 10. EIA/TIA-562 Driver Propagation Delays

SWITCHING WAVEFORMS



Figure 11. EIA/TIA-562 Receiver Propagation Delays



Figure 12. Receiver Enable and Disable Times

APPLICATIONS INFORMATION

Basic Theory of Operation

The LTC1321/LTC1322/LTC1335 each have two interface ports. Each port may be configured as single-ended EIA562 transceiver(s) or differential RS485 transceiver by forcing the port's selection input to a LOW or HIGH, respectively. The LTC1321 provides one EIA562 driver and one EIA562 receiver per port to maintain same pinout as SP301. The LTC1322 and LTC1335 each provide two drivers and two receivers per port. Additionally, the LTC1321 and LTC1322 single-ended ports are RS232 compatible with higher V_{DD} and V_{EE} supply levels.

All the interface drivers feature three-state outputs. Interface outputs are forced into high impedance when the driver is disabled, in the shutdown mode, or with the power off.

All the interface driver outputs are fault protected by a current limiting and thermal shutdown circuit. The thermal shutdown circuit disables both the EIA562 and RS485 driver outputs when the die temperature reaches 150°C. The thermal shutdown circuit enables the drivers when the die temperature cools to 135°C.

In RS485 mode, shutdown mode or with the power off, the input resistance of the receiver is 24k. The input resistance drops to 6.3k in EIA562 mode.

A logic LOW at the \overline{OE} pin shuts down the device and forces all the outputs into a high impedance state. A logic HIGH enables the device. An internal 4 μ A current source to V_{CC} pulls the \overline{OE} pin HIGH if left open.

In RS485 mode, an internal 4 μ A current source pulls the driver enable pin HIGH if left open. The RS485 receiver has a 4 μ A current source at the noninverting input. If both the RS485 receiver inputs are open, the output is a high state. Both the current sources are disabled in the EIA562 mode.

For LTC1335, a logic LOW at the \overline{OE} pin enables all the receiver outputs and a logic HIGH disables all the receiver outputs. An internal 4 μ A current source pulls the \overline{OE} pin LOW if left open.

A loopback mode enables internal connections from driver outputs to receiver inputs for self-test when the

APPLICATIONS INFORMATION

$\overline{\text{LB}}$ pin has a LOW logic state. The driver outputs are not isolated from the external loads. This allows transmitter verification under the loaded condition. An internal 4 μA current source pulls the $\overline{\text{LB}}$ pin HIGH if left open and disables the loopback configuration.

EIA562/RS485 Applications

EIA562 and RS485 output levels are supported when LTC1321/LTC1322/LTC1335 are powered from $\pm 5\text{V}$ supplies. The LTC1321/LTC1322 require the V_{DD} and V_{CC} pins to be tied together and connected to 5V supply (Figure 13). The V_{DD} and V_{CC} are connected internally and brought out at V_{CC} pin in the LTC1335. The unloaded outputs will swing from -5V to 5V in EIA562 mode, and from 0V to 5V in RS485 mode.

RS232/RS485 Applications

If true RS232-compatible outputs are required, the LTC1321/LTC1322 may be used with the V_{DD} and V_{EE} supply voltages increased to provide the additional signal swing. To meet RS232, V_{DD} must be between 6.5V and 10V , and V_{EE} must be between -6.5V and -10V . V_{CC} remains connected to 5V . If only $\pm 12\text{V}$ supplies are available, inexpensive Zener diodes (Z1 and Z2) may be connected in series with V_{DD} and V_{EE} supply pins as shown in Figure 14. An optional 16V Zener diode between V_{CC} and V_{EE} is recommended to keep the maximum voltage between V_{CC} and V_{EE} within safe limits.

LocalTalk®/AppleTalk® Applications

The LTC1321/LTC1322/LTC1335 can be used to provide AppleTalk/LocalTalk-compatible signals in RS485 mode. Figure 15 shows one half of an LTC1335 connected to an LTC1320 AppleTalk transceiver in a typical LocalTalk configuration. Figure 16 shows a typical direct-wire connection with the LTC1335 as the DCE transceiver and the LTC1320 as the DTE transceiver. The LTC1321/LTC1322/LTC1335 RS485 mode is capable of meeting all AppleTalk protocol specifications.

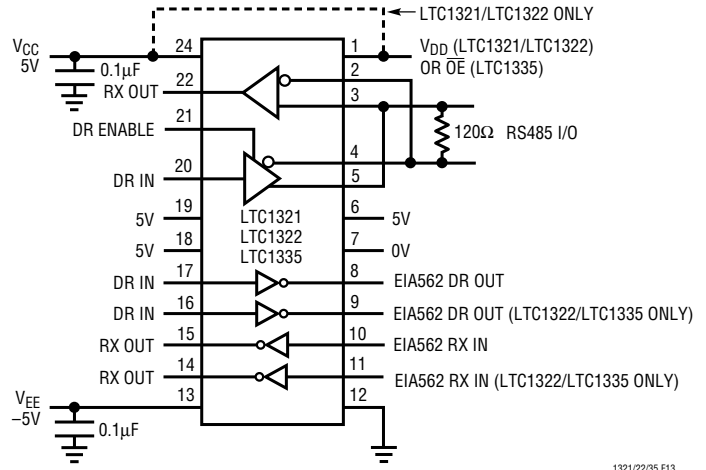

Figure 13. EIA562/RS485 Interfaces with $\pm 5\text{V}$ Supplies

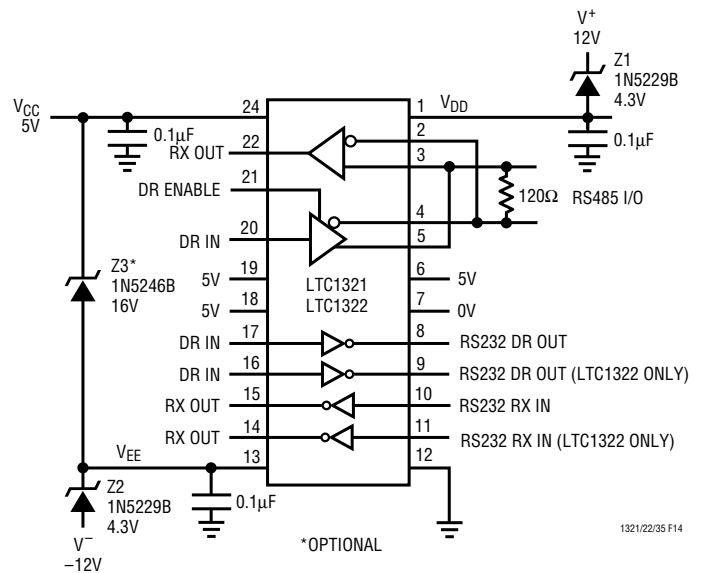

Figure 14. RS232/RS485 Interfaces with 5V , $\pm 12\text{V}$ Supplies

LocalTalk and AppleTalk are registered trademarks of Apple Computer, Inc.

APPLICATIONS INFORMATION



Figure 15. Apple LocalTalk Implemented Using LTC1320 and LTC1335 Transceivers



Figure 16. AppleTalk Direct Connect Using LTC1320 for DTE and LTC1335 for DCE Transceivers

TYPICAL APPLICATIONS

A typical EIA562/RS232 interface application is shown in Figure 17 with LTC1322. A typical EIA562 interface application with LTC1335 is shown in Figure 18.

A typical connection for RS485 transceiver is shown in Figure 19. A twisted pair of wires connects up to 32 drivers

and receivers for half duplex multi-point data transmission. The wires must be terminated at both ends with resistors equal to the wire's characteristic impedance, generally 120Ω . An optional shield around the twisted pair helps to reduce unwanted noise and should be connected to ground at one end.



Figure 17. Typical Connection for EIA562/RS232 Interface



Figure 18. Typical Connection for EIA562 Interface



Figure 19. Typical Connection for RS485 Interface

TYPICAL APPLICATIONS

A typical RS422 connection shown in Figure 20 allows one driver and ten receivers on a twisted pair of wires terminated with a 100Ω resistor at one end. The ground shield is optional.

A typical twisted pair line repeater is shown in Figure 21. As data transmission rate drops with increased cable length, repeater can be inserted to improve transmission rate or to transmit beyond 4000 feet limit.



Figure 20. Typical Connection for RS422 Interface



Figure 21. Typical Cable Repeater for RS422 Interface

TYPICAL APPLICATIONS

The LTC1322/LTC1335 can be used to translate EIA562 to RS422 interface level or vice versa as shown in Figure 22. One port is configured as EIA562 transceiver and the other as RS485 transceiver. The LTC1322 can also support RS232 to RS422 level translation if V_{DD} is between 6.5V and 10V, and V_{EE} is between $-6.5V$ and $-10V$.

Using two LTC1321/LTC1335 as level translators, the EIA562/RS232 interface distance can be extended to 4000 feet with twisted wires (Figure 23).



Figure 22. Typical EIA562/RS232 to RS422 Level Translator



Figure 23. Typical Cable Extension for EIA562/RS232 Interface

PACKAGE DESCRIPTION Dimensions in inches (millimeters) unless otherwise noted.

**N Package
24-Lead Plastic DIP**



**S Package
24-Lead Plastic SOL**

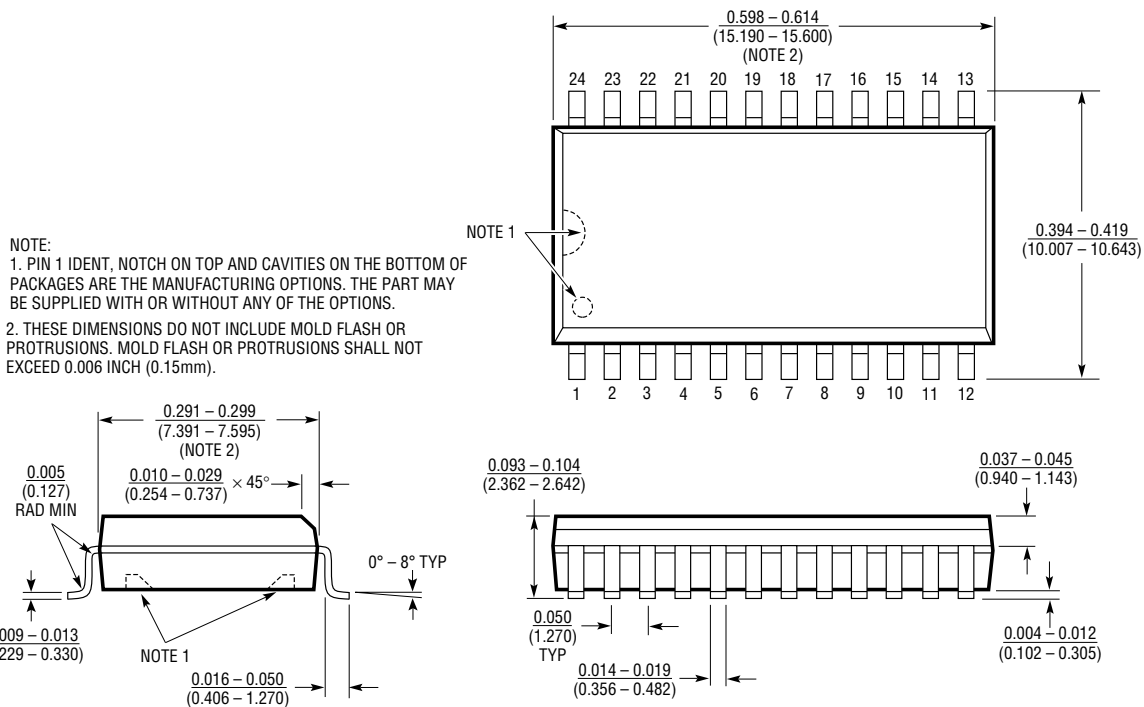

U.S. Area Sales Offices

NORTHEAST REGION

Linear Technology Corporation
One Oxford Valley
2300 E. Lincoln Hwy., Suite 306
Langhorne, PA 19047
Phone: (215) 757-8578
FAX: (215) 757-5631

Linear Technology Corporation

266 Lowell St., Suite B-8
Wilmington, MA 01887
Phone: (508) 658-3881
FAX: (508) 658-2701

SOUTHEAST REGION

Linear Technology Corporation
17060 Dallas Parkway
Suite 208
Dallas, TX 75248
Phone: (214) 733-3071
FAX: (214) 380-5138

CENTRAL REGION

Linear Technology Corporation
Chesapeake Square
229 Mitchell Court, Suite A-25
Addison, IL 60101
Phone: (708) 620-6910
FAX: (708) 620-6977

SOUTHWEST REGION

Linear Technology Corporation
22141 Ventura Blvd.
Suite 206
Woodland Hills, CA 91364
Phone: (818) 703-0835
FAX: (818) 703-0517

NORTHWEST REGION

Linear Technology Corporation
782 Sycamore Dr.
Milpitas, CA 95035
Phone: (408) 428-2050
FAX: (408) 432-6331

International Sales Offices

FRANCE

Linear Technology S.A.R.L.
Immeuble "Le Quartz"
58 Chemin de la Justice
92290 Chatenay Malabry
France
Phone: 33-1-41079555
FAX: 33-1-46314613

GERMANY

Linear Technolgy GmbH
Untere Hauptstr. 9
D-85386 Eching
Germany
Phone: 49-89-3197410
FAX: 49-89-3194821

JAPAN

Linear Technology KK
5F YZ Bldg.
4-4-12 Iidabashi, Chiyoda-Ku
Tokyo, 102 Japan
Phone: 81-3-3237-7891
FAX: 81-3-3237-8010

KOREA

Linear Technology Korea Branch
Namsong Building, #505
Itaewon-Dong 260-199
Yongsan-Ku, Seoul
Korea
Phone: 82-2-792-1617
FAX: 82-2-792-1619

SINGAPORE

Linear Technology Pte. Ltd.
101 Boon Keng Road
#02-15 Kallang Ind. Estates
Singapore 1233
Phone: 65-293-5322
FAX: 65-292-0398

TAIWAN

Linear Technology Corporation
Rm. 801, No. 46, Sec. 2
Chung Shan N. Rd.
Taipei, Taiwan, R.O.C.
Phone: 886-2-521-7575
FAX: 886-2-562-2285

UNITED KINGDOM

Linear Technology (UK) Ltd.
The Coliseum, Riverside Way
Camberley, Surrey GU15 3YL
United Kingdom
Phone: 44-276-677676
FAX: 44-276-64851

World Headquarters

Linear Technology Corporation
1630 McCarthy Blvd.
Milpitas, CA 95035-7487
Phone: (408) 432-1900
FAX: (408) 434-0507

Компания «Life Electronics» занимается поставками электронных компонентов импортного и отечественного производства от производителей и со складов крупных дистрибьюторов Европы, Америки и Азии.

С конца 2013 года компания активно расширяет линейку поставок компонентов по направлению коаксиальный кабель, кварцевые генераторы и конденсаторы (керамические, пленочные, электролитические), за счёт заключения дистрибьюторских договоров

Мы предлагаем:

- Конкурентоспособные цены и скидки постоянным клиентам.
- Специальные условия для постоянных клиентов.
- Подбор аналогов.
- Поставку компонентов в любых объемах, удовлетворяющих вашим потребностям.
- Приемлемые сроки поставки, возможна ускоренная поставка.
- Доставку товара в любую точку России и стран СНГ.
- Комплексную поставку.
- Работу по проектам и поставку образцов.
- Формирование склада под заказчика.
- Сертификаты соответствия на поставляемую продукцию (по желанию клиента).
- Тестирование поставляемой продукции.
- Поставку компонентов, требующих военную и космическую приемку.
- Входной контроль качества.
- Наличие сертификата ISO.

В составе нашей компании организован Конструкторский отдел, призванный помогать разработчикам, и инженерам.

Конструкторский отдел помогает осуществить:

- Регистрацию проекта у производителя компонентов.
- Техническую поддержку проекта.
- Защиту от снятия компонента с производства.
- Оценку стоимости проекта по компонентам.
- Изготовление тестовой платы монтаж и пусконаладочные работы.



Тел: +7 (812) 336 43 04 (многоканальный)
Email: org@lifeelectronics.ru