

NB3M8T3910GEVB

NB3M8T3910G Evaluation Board User's Manual



ON Semiconductor®

<http://onsemi.com>

EVAL BOARD USER'S MANUAL

Introduction

The NB3M8T3910GEVB is a custom evaluation board developed by ON Semiconductor for the NB3M8T3910G. This evaluation board was designed to provide a flexible and convenient platform to quickly evaluate, characterize and verify the operation of the NB3M8T3910G.

This evaluation board manual contains:

- Information on the NB3M8T3910G Evaluation Board
- Assembly Instructions
- Test and Measurement Setup Procedures
- Bill of Materials

This manual should be used in conjunction with the device datasheet [NB3M8T3910/D](#) which contains full technical details on the device specifications and operation.

Top View

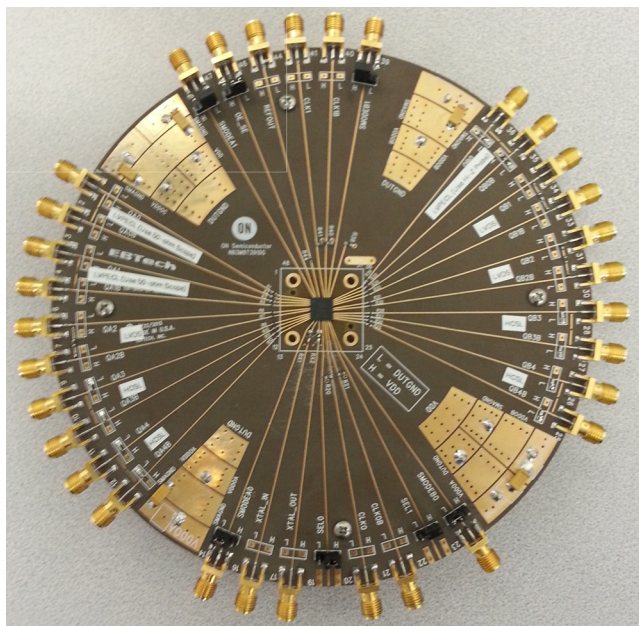

Bottom View

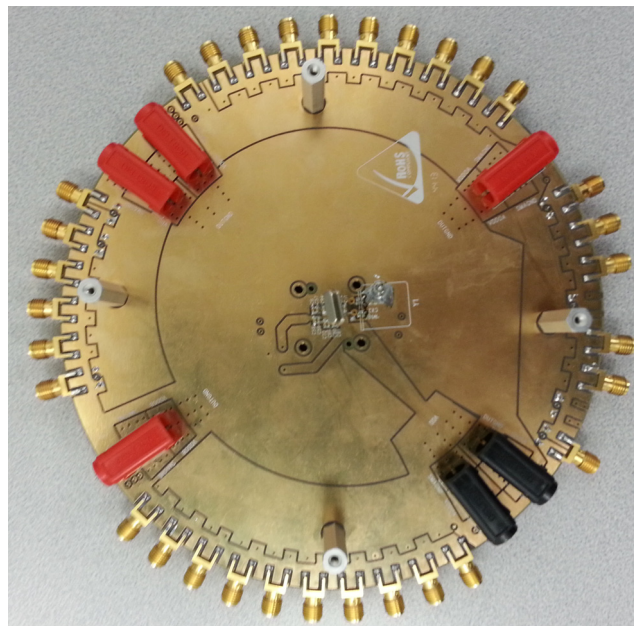

Figure 1. NB3M8T3910GEVB Top and Bottom View

READ FIRST – INTRODUCTION

The NB3M8T3910G has two banks of 5 differential outputs. Each output bank can be independently selected as LVPECL, LVDS or HCSL outputs by the SMODEAx/Bx select pins.

This evaluation board, NB3M8T3910GEVB, has been configured to evaluate each output type.

Of the ten possible differential outputs, three are dedicated as LVPECL, three are dedicated as LVDS and four are dedicated as HCSL (labeled on board).

The Single-Ended LVCMOS Output, REFOUT, is controlled by the Synchronous OE_SE pin. For Clock frequencies above 250 MHz, the REFOUT line should be disabled.

Each dedicated output pair on the board is configured per Table 1 below:

NB3M8T3910GEVB

Table 1. OUTPUT DEDICATION OF THE NB3M8T3910GEVB

Output Pin Name	Output Type (Dedicated)	SMODEA [1:0]	SMODEB [1:0]	Output Measurement Method
QA0/QA0b	LVPECL	0 0	x x	Use 50-Ω Scope Head; there is no load on the board
QA1/QA1b	LVPECL	0 0	x x	Use 50-Ω Scope Head; there is no load on the board
QA2/QA2b	LVDS	0 1	x x	Measure with Single or Differential Hi-Z Probes; Outputs have 100-Ω termination resistor across at SMA connectors
QA3/QA3b	HCSL	1 0	x x	Use 50-Ω Scope Head; there is no 50-Ω to GND on the board; or install 50-Ω SMA terminators and use a Hi-Z probe
QA4/QA4b	HCSL	1 0	x x	Use 50-Ω Scope Head; there is no 50-Ω to GND on the board; or install 50-Ω SMA terminators and use a Hi-Z probe
QB0/QB0b	LVPECL	x x	0 0	Measure with Single or Differential Hi-Z Probes; these LVPECL outputs have a Thevenin termination resistor network.
QB1/QB1b	LVDS	x x	0 1	Measure with Single or Differential Hi-Z Probes; Outputs have 100-Ω termination resistor across at SMA connectors
QB2/QB2b	LVDS	x x	0 1	Measure with Single or Differential Hi-Z Probes; Outputs have 100-Ω termination resistor across at SMA connectors
QB3/QB3b	HCSL	x x	1 0	Measure with Single or Differential Hi-Z Probes; there is 50-Ω to GND on the board
QB4/QB4b	HCSL	x x	1 0	Use 50-Ω Scope Head; there is no 50-Ω to GND on the board; or install 50-Ω SMA terminators and use a Hi-Z probe

NOTE: x = don't care

LVDS OUTPUT CONFIGURATION

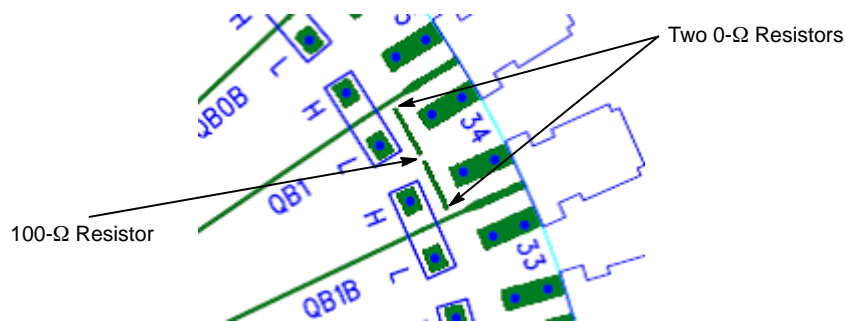

Figure 2. LVDS Output Configuration

LVDS outputs are typically terminated with 100-Ω across the Q & Qb output pair.

On QA2/QA2b, QB1/QB1b, QB2/QB2b, there are on-board 100-ohm output termination resistors across the

LVDS outputs. Two 0-Ω resistors connect the metal traces and a 100-Ω resistor connects between the traces.

Use a single-ended or differential high-impedance probe across the 100-Ω resistor.

NB3M8T3910GEVB

HCSL OUTPUT CONFIGURATION

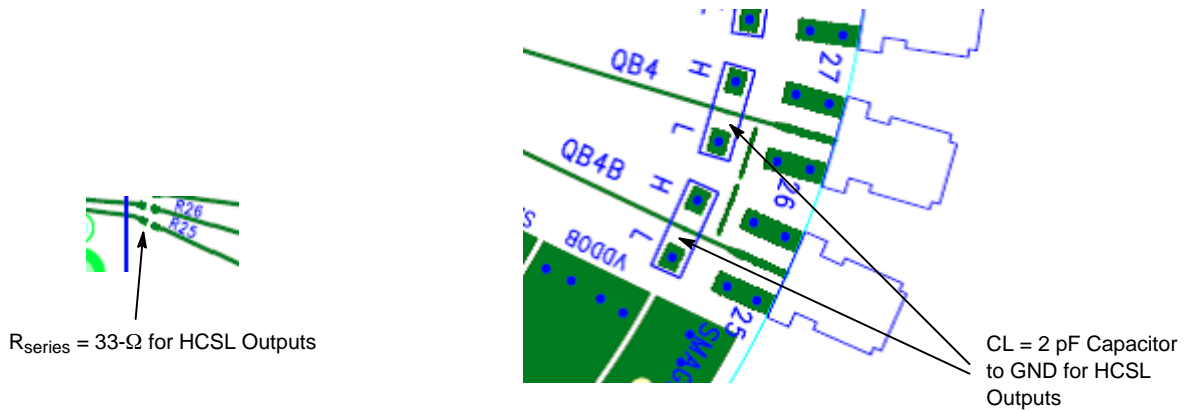

Figure 3. HCSL Output Configuration

HCSL outputs are typically loaded and terminated with a $R_{series} = 33\text{-}\Omega$ and $50\text{-}\Omega$ to ground. This can be easily accomplished by connecting the HCSL outputs to the $50\text{-}\Omega$ internal impedance in the oscilloscope.

On QA3/QA3b, QA4/QA4b, QB3/QB3b, QB4/QB4b, there are on-board $R_{series} = 33\text{-}\Omega$ series termination resistors

installed for each HCSL output. Also, there is a $CL = 2\text{ pF}$ installed to GND.

For QA3/QA3b, QA4/QA4b, QB4/QB4b use $50\text{-}\Omega$ to GND of oscilloscope sampling head to satisfy the HCSL output loading. QB3/QB3b has a $50\text{-}\Omega$ output load, thus use a Hi-Z probe for measurements.

LVPECL OUTPUT CONFIGURATION

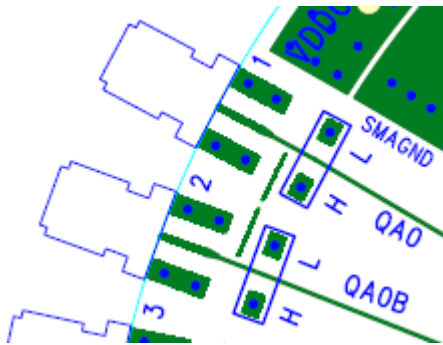

Figure 4. LVPECL Output Configuration

On QA0/QA0b or QA1/QA1b, there is no on-board LVPECL output loading or termination.

Use the $50\text{-}\Omega$ to GND of the oscilloscope sampling head to satisfy the LVPECL output loading and termination. This single supply scheme will simplify the LVPECL output testing versus a split power supply. **However, this method will actually draw more output current with a single power supply versus a dual/split power supply.** Nevertheless, this extra output current will be within the Maximum Ratings limit.

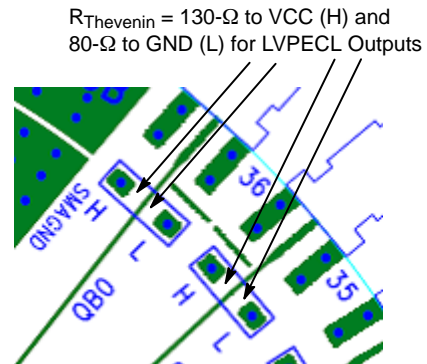

Figure 5. LVPECL Output Configuration, Thevenin Termination Resistors

On QB0/QB0b, there is an on-board Thevenin output loading and termination resistor network; $130\text{-}\Omega$ from LVPECL output to VDDO and $80\text{-}\Omega$ from output to GND. This arrangement will satisfy the LVPECL DC output loading and AC termination.

Use single-ended or differential high-impedance probes.

See [AND8020/D](#), section 3, for more information.

QUICK START LAB SET-UP USER'S GUIDE

“Split” or Dual Power Supply Connections

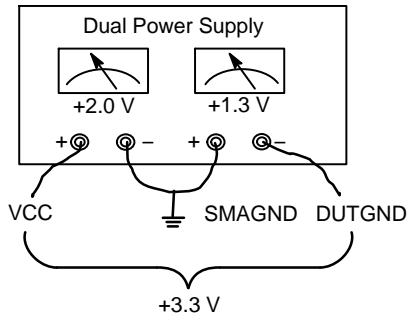

Figure 6. LVPECL – “Split” or Dual Power Supply Configuration

Most ECL outputs are open emitter and need to be DC loaded and AC terminated to $VCC - 2.0\text{ V}$ via a $50\ \Omega$ resistor. For standard ECL lab setup and test, a split (dual) power supply is recommended enabling the $50\text{-}\Omega$ internal impedance in the oscilloscope, or other measuring instrument, to be used as an ECL output load/termination. By offsetting $VCC = +2.0\text{ V}$, $SMAGND = VCC - 2.0\text{ V} = 0\text{ V}$, $SMAGND$ is the system ground, 0 V , and $DUTGND$ is -1.3 V or -0.5 V .

More information on ECL termination is provided in [AND8020/D](#).

Power Supply Connector	“Split” Power Supply
VDD/VDDOx	$VCC = +2.0\text{ V}$
SMAGND	$VTT = 0\text{ V}$
DUTGND	$DUTGND = -1.3\text{ V}$ for 3.3 V p/s or -0.5 V for 2.5 V p/s

LVC MOS OUTPUT CONFIGURATION

On REFOUT use a Hi-Z probe or the following set up to use a $50\ \Omega$ to GND sampling head Oscilloscope.

“Split” or Dual Power Supply Connections

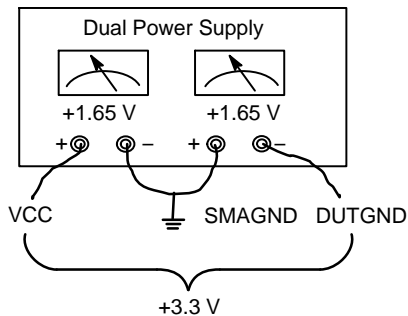

Figure 7. LVC MOS – “Split” or Dual Power Supply Configuration

Power-Up, Input and Output Connections

1. Connect the VDD and VDDOx banana jacks with power supply cables to $+3.3\text{ V}$, and DUTGND and SMAGND to 0 V .
2. Select Crystal input and monitor 25 MHz on each Qn output.
3. Connect a signal generator to the SMA connectors for CLK0/CLK0b or CLK1/CLK1b inputs. 50-ohm termination resistors are installed for a signal generator on the board. Set appropriate input signal levels and frequency.
4. Observe the Qn outputs with a high-Z probe oscilloscope.

Table 2. POWER SUPPLY CONNECTIONS

Device Pin	Power Supply
VDD	$+3.3\text{ V}$
VDDOx	$+3.3\text{ V}$
SMAGND	0 V
DUTGND	0 V

Single Power Supply Connections

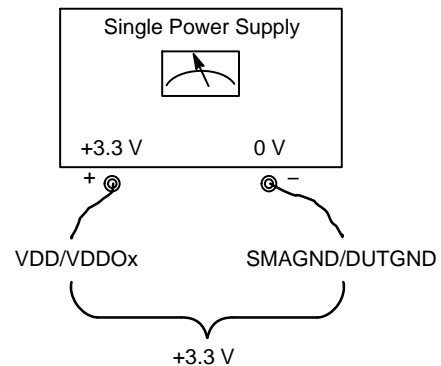

Figure 8. Single Power Supply Configuration

NB3M8T3910GEVB

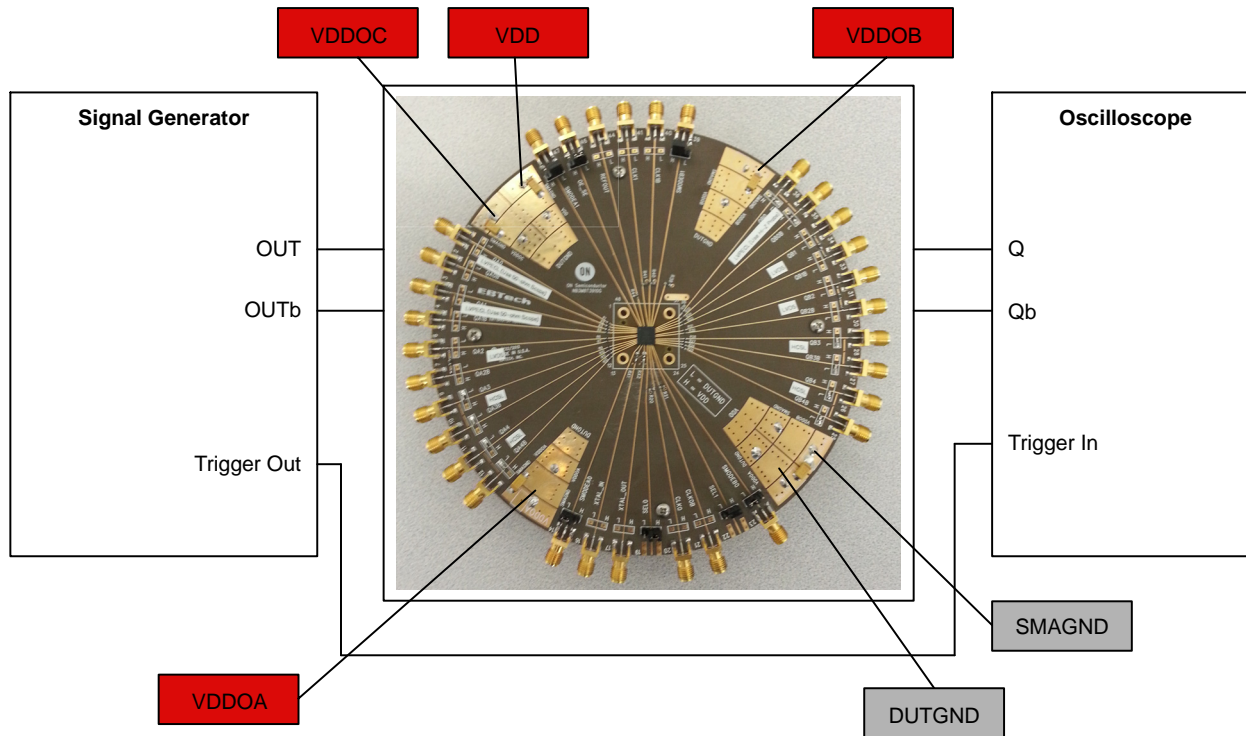

Figure 9. Typical Lab Test Set-Up

Board Layout

The custom QFN-48 Evaluation Board provides a high bandwidth, 50-Ω controlled impedance environment and is implemented in four layers. The first layer or primary “high-speed” trace layer is FR4 material, and is designed to have equal electrical length on all signal traces from the device under test (DUT) pins to the SMA connectors. The

second layer is the 0.5 oz copper ground plane and is dedicated for the SMA connector ground plane. FR4 dielectric material is placed between the second and third layers and between third and fourth layers. The third layer is also 0.5 oz copper plane. A portion of this layer is designated for the device VDD and DUTGND power planes. The fourth layer is the VDDOx layer.

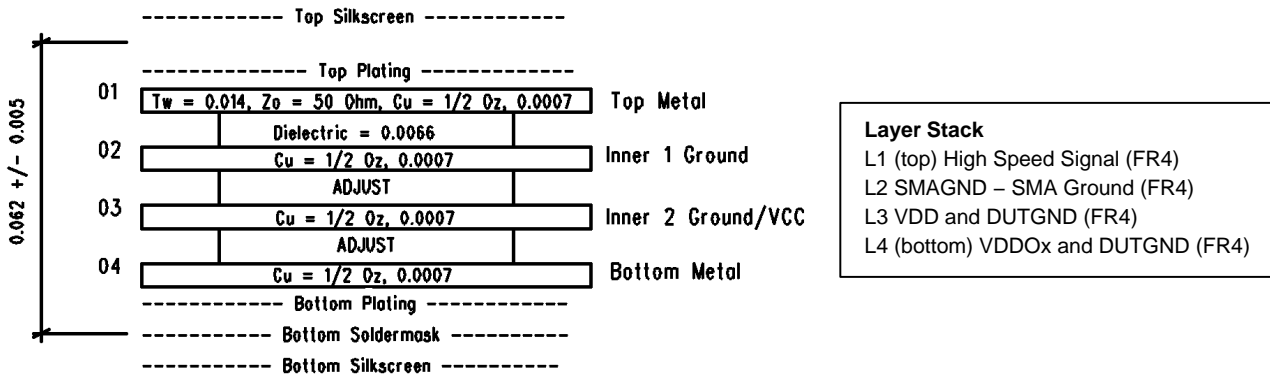

Figure 10. QFN-48 Evaluation Board Layout, 4-Layer Stack

Table 2 and Figure 8 describes the board configuration for the power supplies, Figure 3 shows typical input and output connections.

VDD is the positive power supply.

VDDOA, VDDOB, VDDOC are the positive power supplies for the outputs.

DUTGND (Device Under Test Ground) is the negative power supply for the device. Banana jack is labeled DUTGND.

Exposed Pad (EP). The exposed pad footprint on the board is mechanically connected (soldered) to the exposed pad of the QFN-48 package, and is electrically connected to DUTGND power supply.

NB3M8T3910GEVB

SMAGND is the ground for the SMA connectors, is always 0 V and is not to be confused with the device ground, DUTGND. SMAGND and DUTGND can be connected in single-supply applications.

XTAL_IN Crystal

A 25 MHz crystal is installed. Set the SELx pins in Table 3 of datasheet to select crystal. 27 pF load capacitors are installed.

If a single-ended Clock input is needed to drive XTAL_IN, then remove the crystal and load capacitor, and install a 0-ohm resistor on RX1 and a 50-ohm resistor on RT1 on bottom side. This 50-ohm to GND will terminate the signal generator. Use the XTAL_IN SMA connector.

Evaluation Board Assembly Instructions

The NB3M8T3910GEVB evaluation board was designed for characterizing devices in a 50-Ω laboratory environment using high bandwidth equipment and accommodates a custom QFN-48 socket. Table 3 contains the Bill of Materials for this evaluation board.

Solder the Device on the Evaluation Board

The soldering of a QFN-48 package to the evaluation board can be accomplished by hand soldering or solder reflow techniques using solder paste and a hot air source. Make sure pin 1 of the device is located properly and all the pins are aligned to the footprint pads. Solder the device to the evaluation board.

Installing the SMA Connectors

Each high-speed input and output has an SMA connector installed on the board. Install all the required SMA connectors onto the board and solder the center signal conductor pin to the board. Please note that the alignment of the center signal connector pin of the SMA connector to the metal trace on the board can influence lab results. The launch and reflection of the signals are largely influenced by imperfect alignment and soldering of the SMA connector.

Power Supply Configuration

Install the power supply banana jacks on the bottom side; install the appropriate bypass capacitors on top and bottom sides.

The positive power supply banana jack connector for the core and inputs is labeled VDD.

The positive power supply banana jack connector for the outputs is labeled VDDOA/B/C.

The device negative power supply banana jack connector is labeled DUTGND.

The SMA Ground plane/supply banana jack connector is labeled SMAGND.

The power supply banana jacks and typical capacitor by-pass connections of the evaluation board are shown in Figure 11.

It is recommended to add power supply bypass capacitors at the device pins to reduce unwanted noise.

10 μF capacitors are connected from VDD and VDDOx and DUTGND, to SMAGND at the banana jacks.

A 0.1 μF capacitor is installed from each VDD and VDDOx pin to SMAGND.

NOTE: Exposed Pad = DUTGND

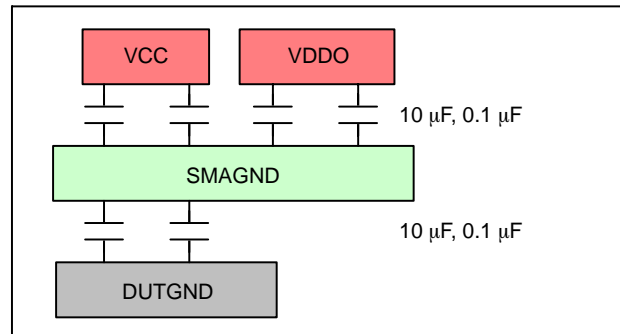

Figure 11. Typical Power Supply By-Pass Capacitor Arrangement

NB3M8T3910GEVB

LVPECL QA1/QA1b 50-Ω TO GND OF OSCILLOSCOPE



Figure 12. 50 MHz



Figure 13. 100 MHz

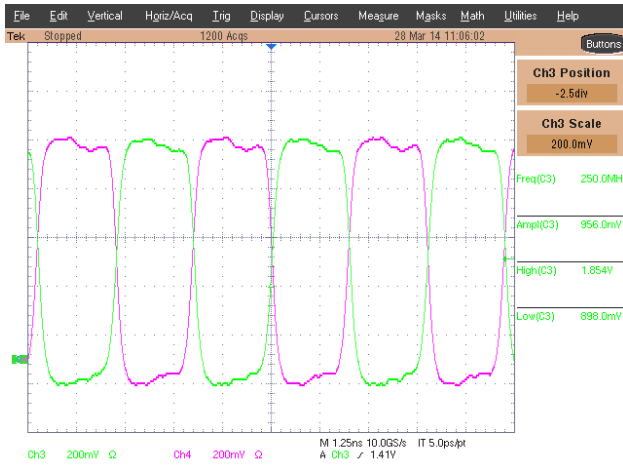

Figure 14. 250 MHz

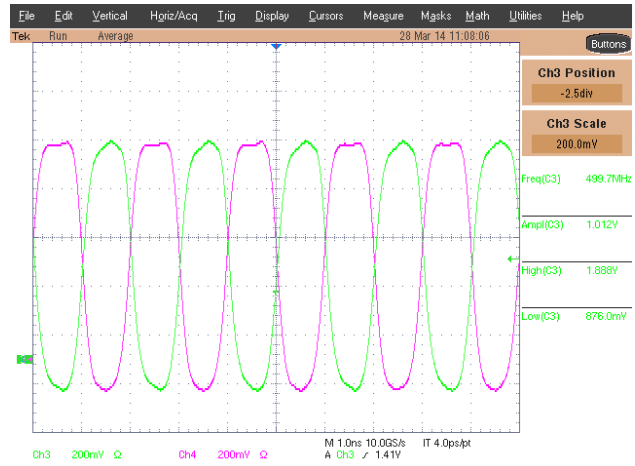

Figure 15. 500 MHz

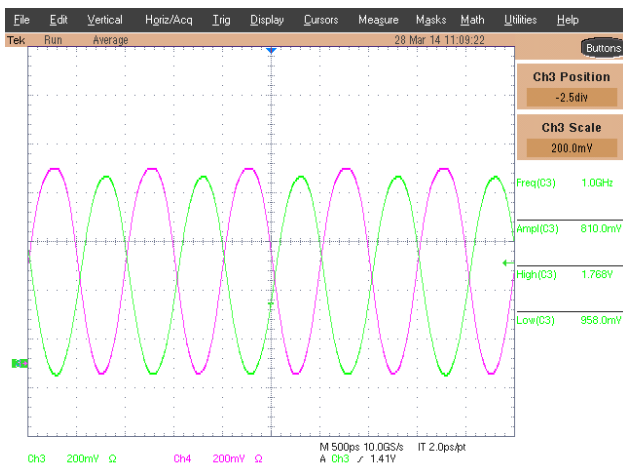

Figure 16. 1000 MHz

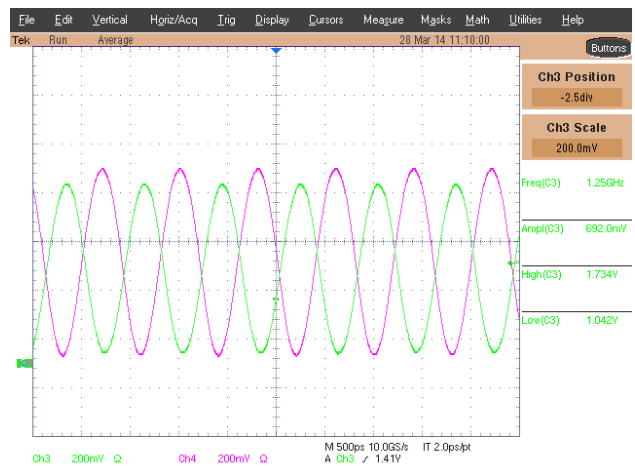

Figure 17. 1250 MHz

NB3M8T3910GEVB

LVPECL QA1/QA1b 50-Ω TO GND OF OSCILLOSCOPE

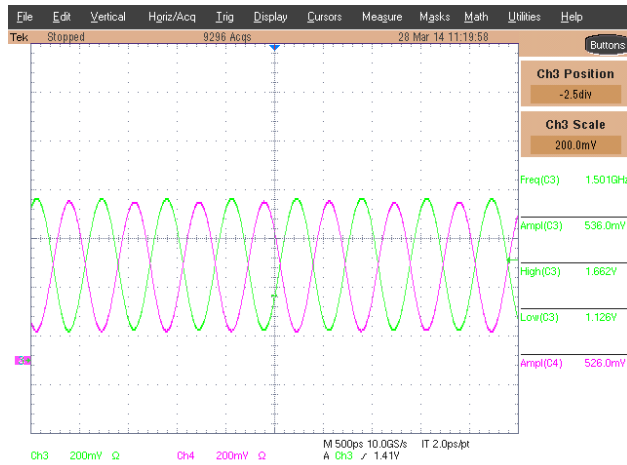

Figure 18. 1500 MHz

NB3M8T3910GEVB

LVPECL QB0/QB0b HI-Z PROBE OSCILLOSCOPE

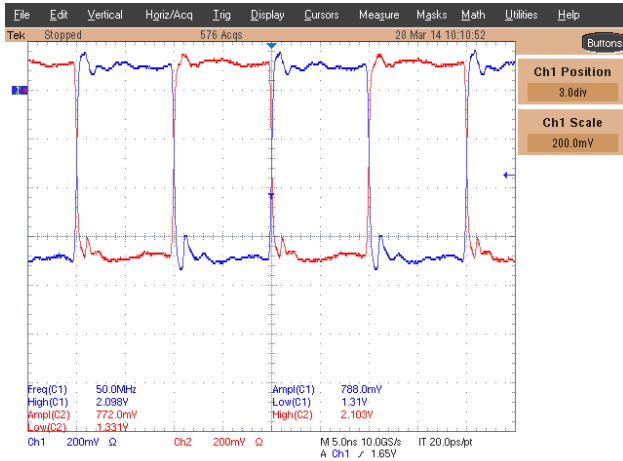

Figure 19. 50 MHz

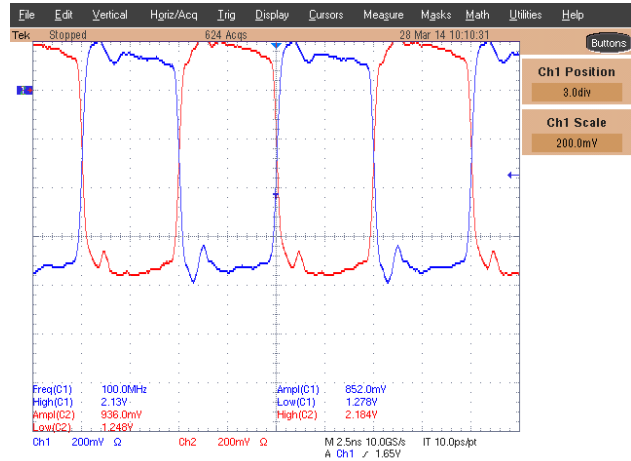

Figure 20. 100 MHz

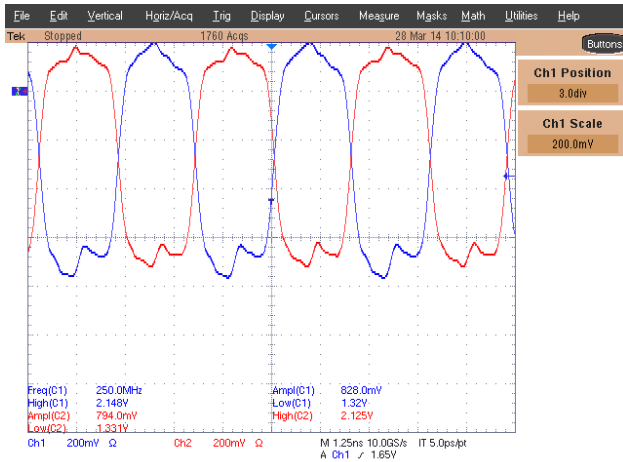

Figure 21. 250 MHz

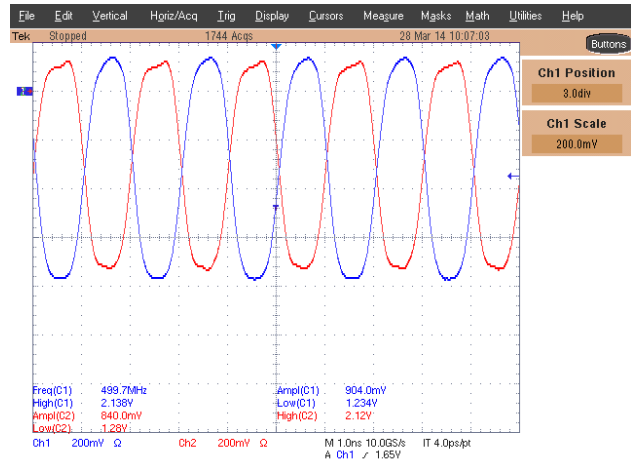

Figure 22. 500 MHz

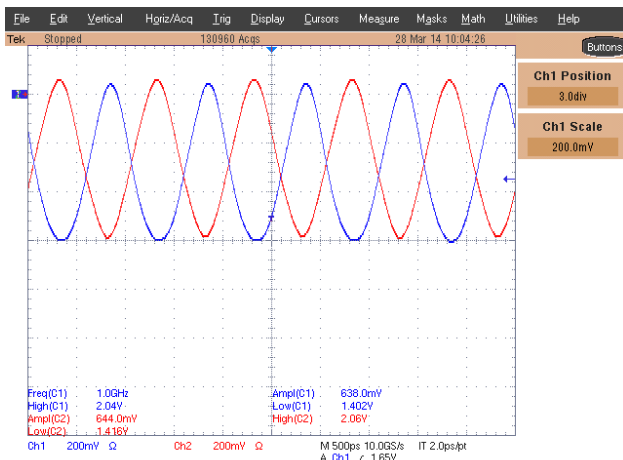

Figure 23. 1000 MHz

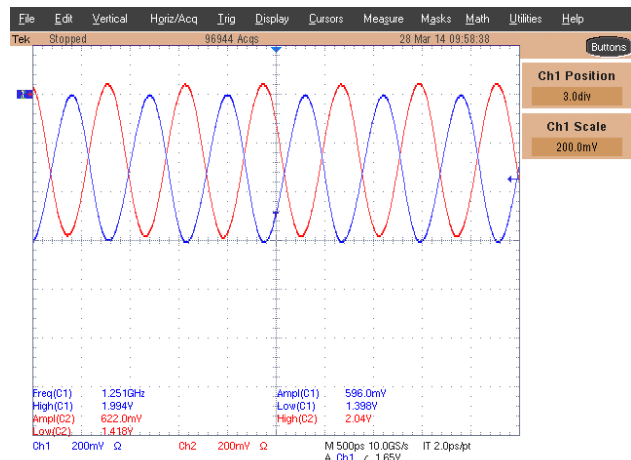

Figure 24. 1250 MHz

NB3M8T3910GEVB

LVPECL QB0/QB0b HI-Z PROBE OSCILLOSCOPE

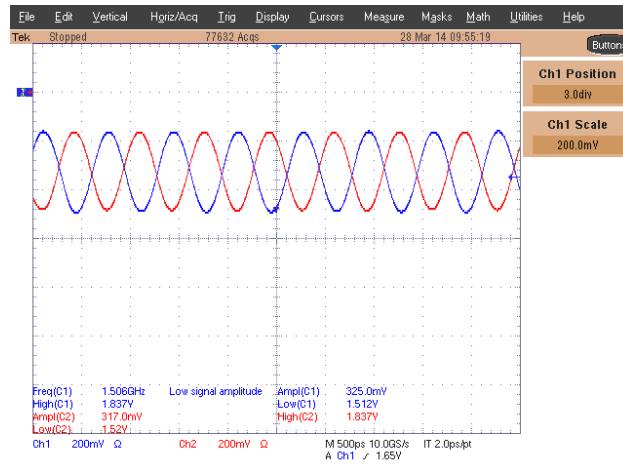

Figure 25. 1500 MHz

NB3M8T3910GEVB

LVDS QB1/QB1b SINGLE-ENDED HI-Z PROBE OSCILLOSCOPE



Figure 26. 50 MHz

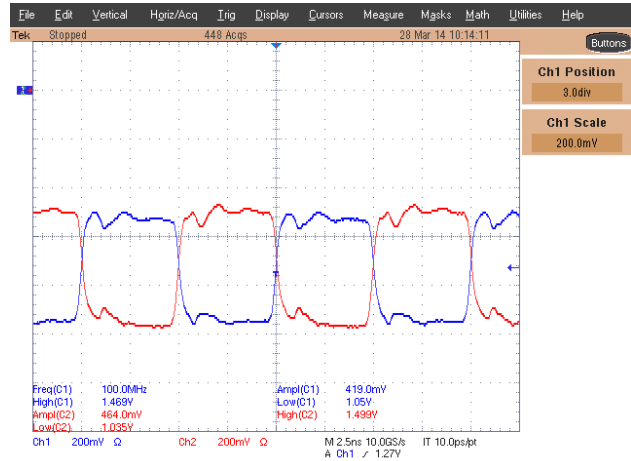

Figure 27. 100 MHz

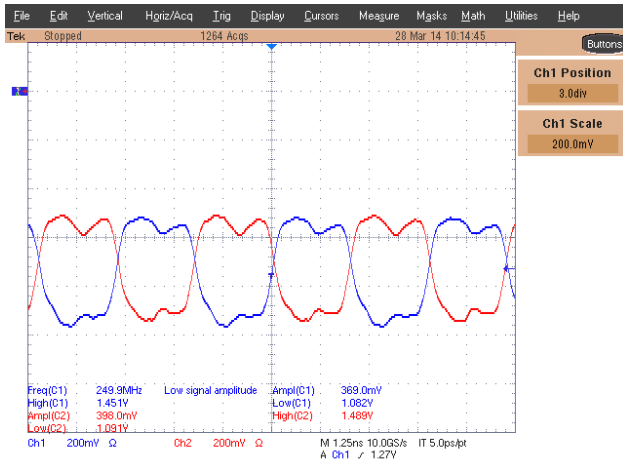

Figure 28. 250 MHz

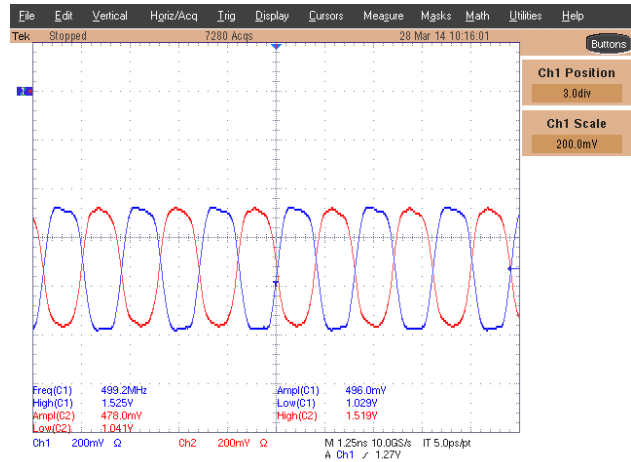

Figure 29. 500 MHz

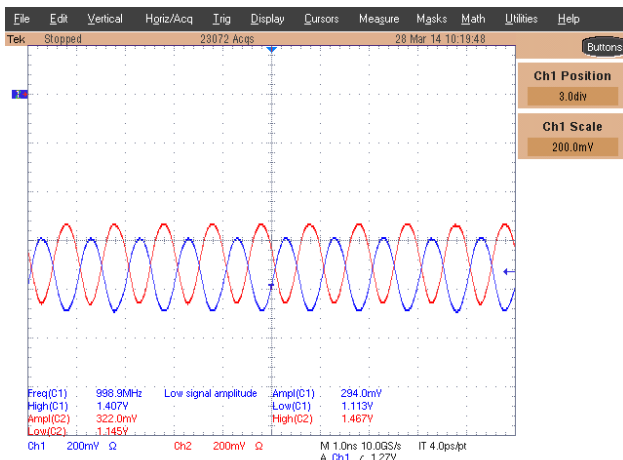

Figure 30. 1000 MHz

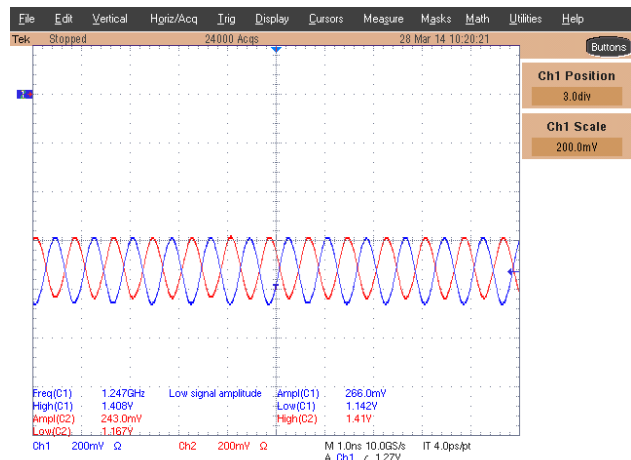

Figure 31. 1250 MHz

NB3M8T3910GEVB

LVDS QB1/QB1b SINGLE-ENDED HI-Z PROBE OSCILLOSCOPE

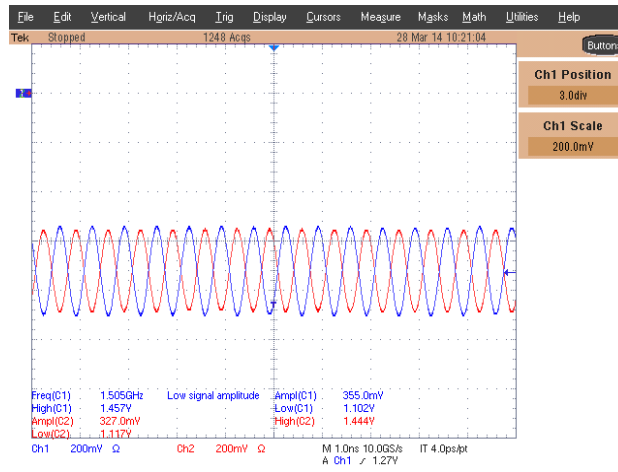

Figure 32. 1500 MHz

NB3M8T3910GEVB

LVDS QB1/QB1b DIFFERENTIAL HI-Z PROBE OSCILLOSCOPE

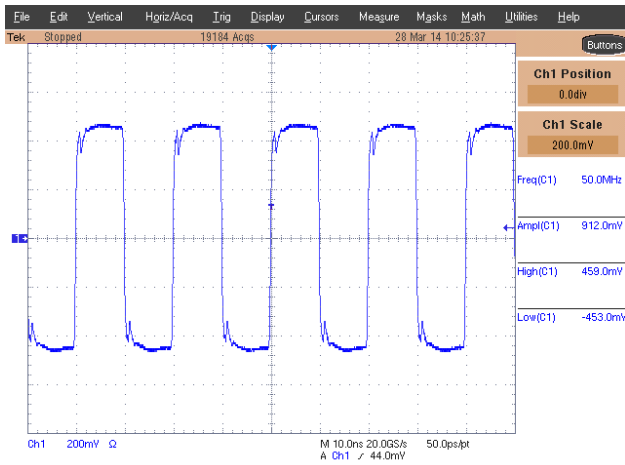

Figure 33. 50 MHz

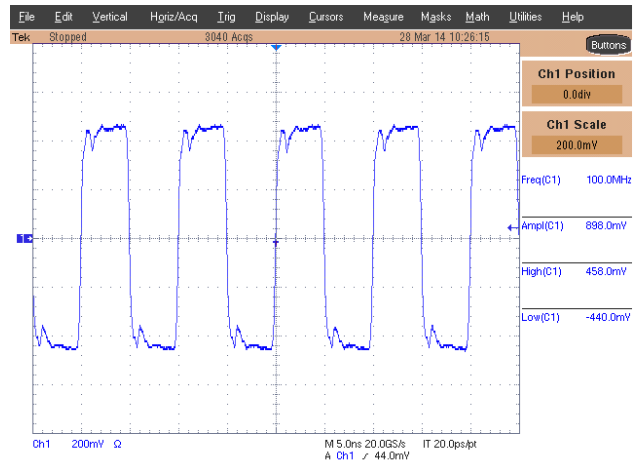

Figure 34. 100 MHz

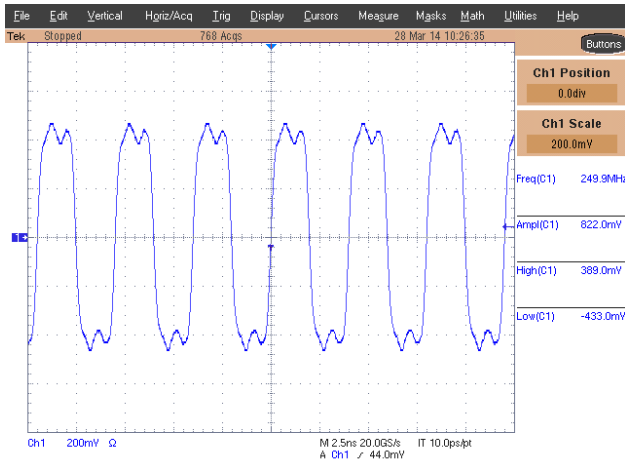

Figure 35. 250 MHz

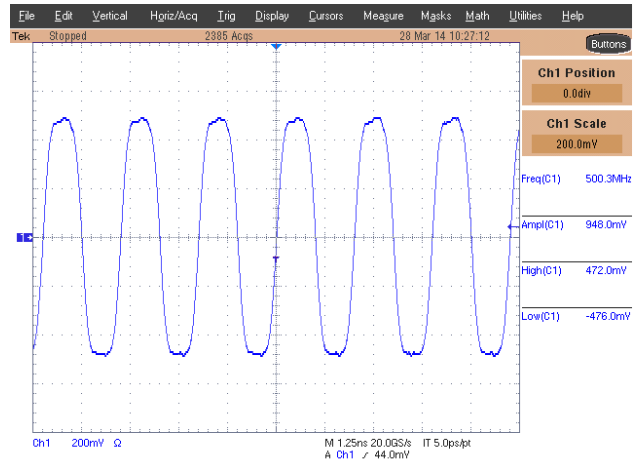

Figure 36. 500 MHz

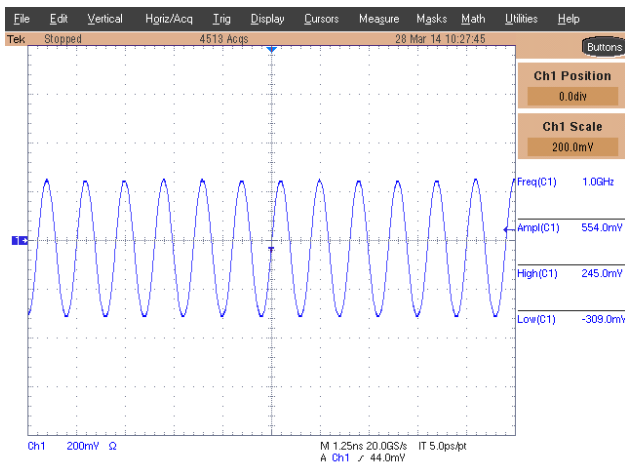

Figure 37. 1000 MHz

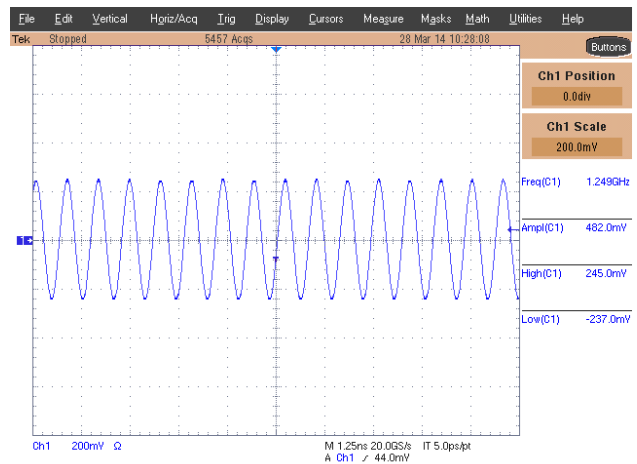

Figure 38. 1250 MHz

NB3M8T3910GEVB

LVDS QB1/QB1b DIFFERENTIAL HI-Z PROBE OSCILLOSCOPE

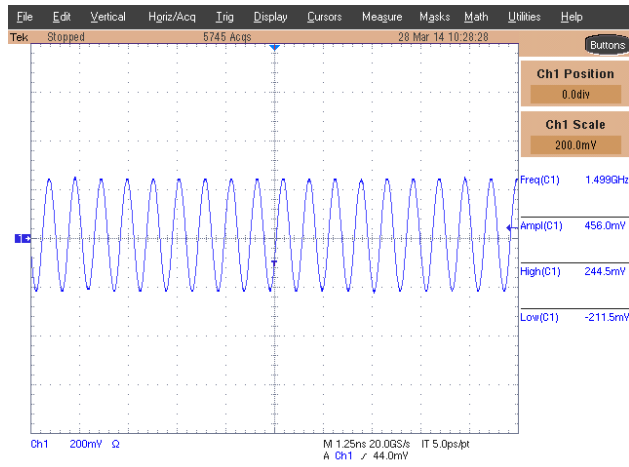

Figure 39. 1500 MHz

NB3M8T3910GEVB

HCSL QA3/QA3b 50-Ω TO GND OF OSCILLOSCOPE

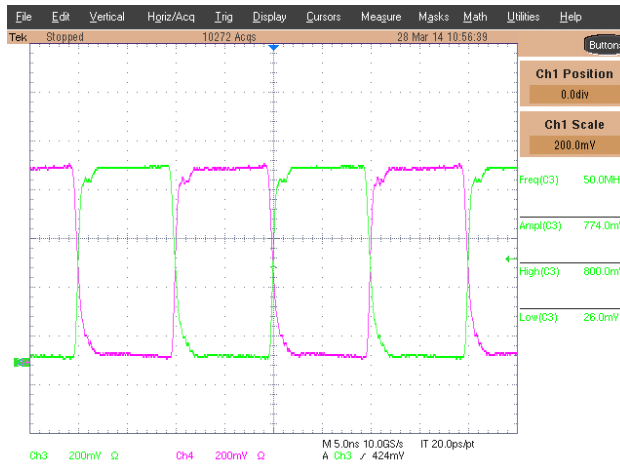

Figure 40. 50 MHz

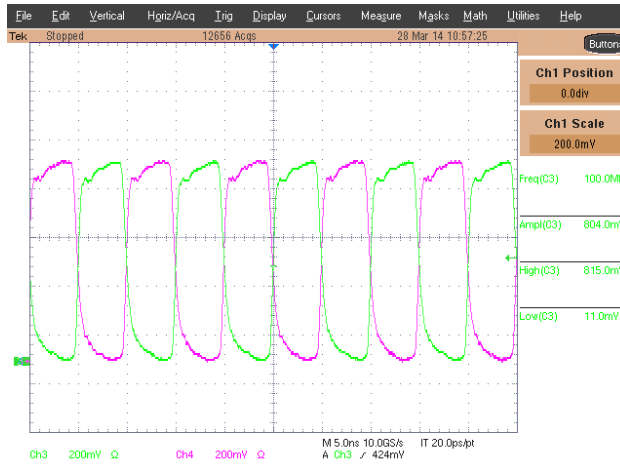

Figure 41. 100 MHz

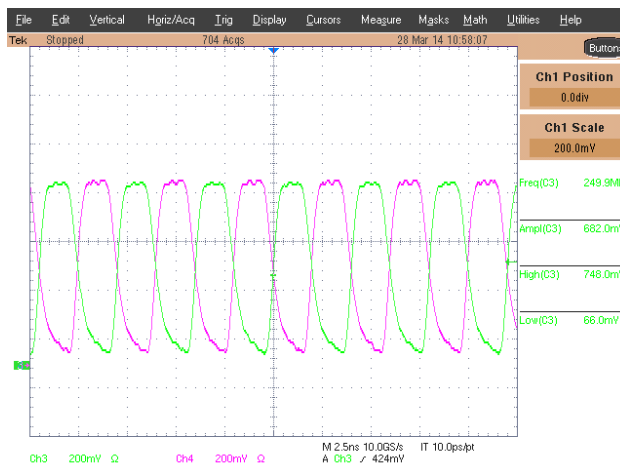

Figure 42. 250 MHz

NB3M8T3910GEVB

HCSL QB3/QB3b HI-Z PROBE OSCILLOSCOPE

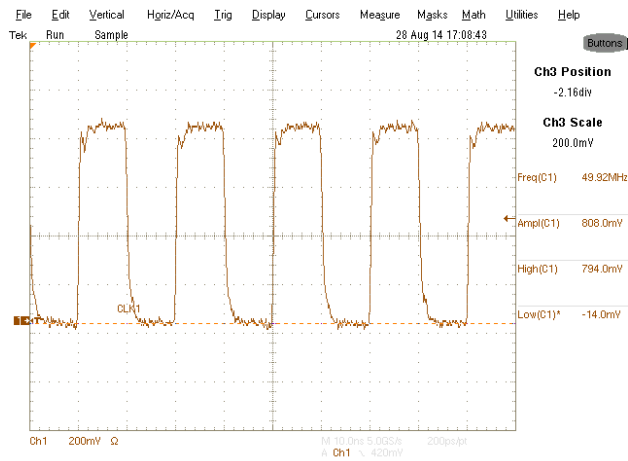

Figure 43. 50 MHz

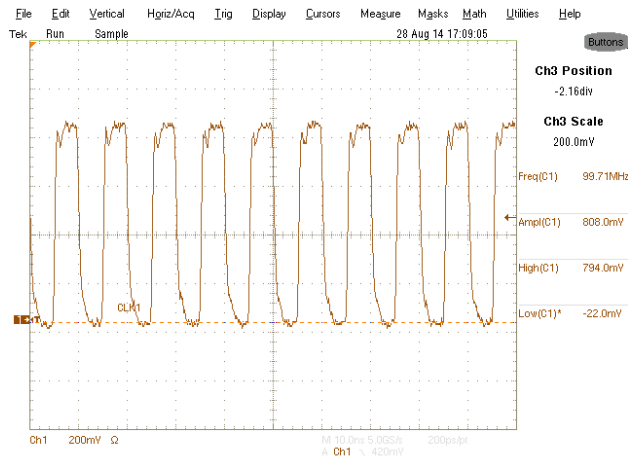

Figure 44. 100 MHz

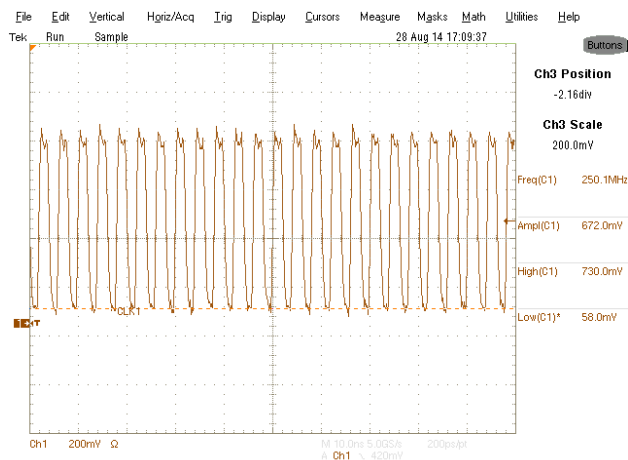

Figure 45. 250 MHz

NB3M8T3910GEVB

LVC MOS REFOUT

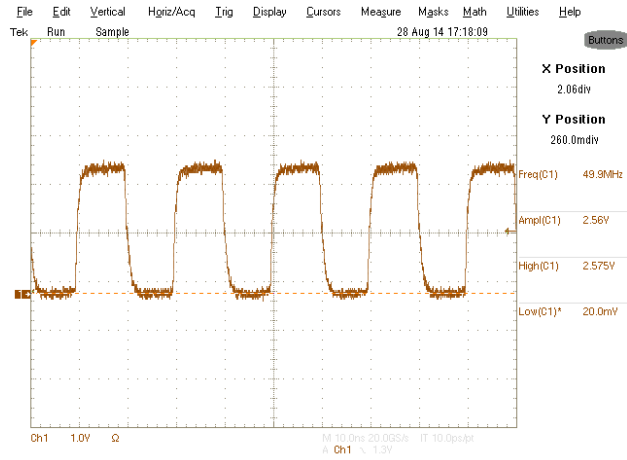

Figure 46. 50 MHz

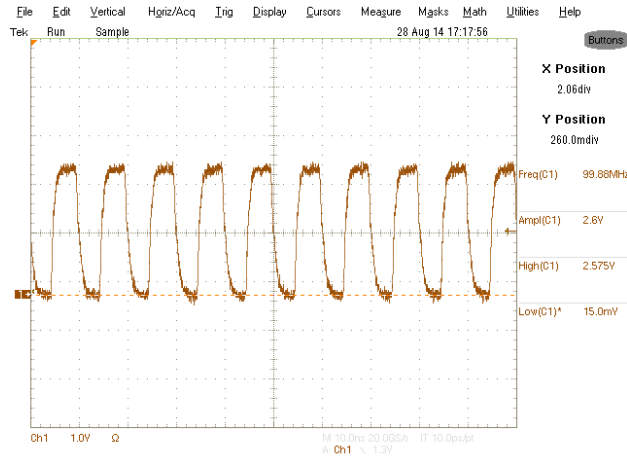

Figure 47. 100 MHz

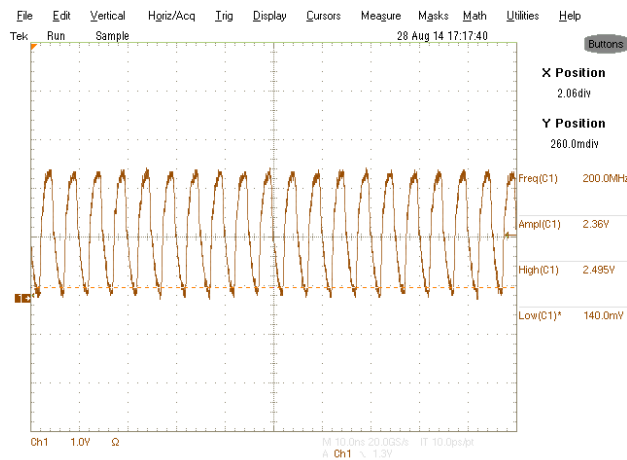

Figure 48. 200 MHz

NB3M8T3910GEVB

BILL OF MATERIALS

Table 3. NB3M8T3910GEVB BILL OF MATERIALS

Component	Qty.	Description	Manufacturer	Part Number	Web Site
SMA Connector	32	Edge Mount	Johnson	142-0711-821	
Banana Jack Connector	4	Red – Side Launch	Deltron	571-0500	Mouser #164-6219
Banana Jack Connector	2	Black – Side Launch	Deltron	571-0100	Mouser #164-6218
Chip Resistor R1, R2, R3, R4, R6, R7, R30, R31, R33-R36, R44	13 + 6	0-Ω 0402	Vishay	CRCW04020000Z0ED	Digi-Key 541-0.0JCT-ND
Chip Resistor R9-R12, R25-R28	8	33-Ω 0402	Panasonic	ERJ-2RKF33R0X	Digi-Key ERJ-2RKF33R0X
Chip Resistor R20, R21, R40, R41	4	50-Ω 1%, 0402	Vishay	FC0402E50R0FST1	Digi-Key FC0402E50R0FST1-ND
Chip Resistor	3	100-Ω 0402	Vishay	FC0402E1000FST1	Digi-Key FC0402E1000FST1-ND
Chip Resistor R38	1	475-Ω 0402	Vishay	MCS04020C4750FE000	Digi-Key 2312 275 14751-ND
	2	27 pF Crystal Load			
Capacitor	5	10 μF ±10%, Case "C" 25 V or 16 V	KEMET	T491C106K025AT T491C106K016AS	
Chip Capacitor C6, C57, C58, C59, C64, C72, C80, C81, C91-C96	14	0.1 μF ±10%, 0603 0.1 μF ±10%, 0402	AVX	0603C104KAT2A 0402ZD104KAT2A	www.avx.com Digi-Key 478-1129-1-ND
Chip Capacitor	6	2 pF	TDK	C1005C0G1H020C	Digi-Key 445-4863-1-ND
Header J14, J19, J22, J23, J39, J46, J47	7	3-Pin3 Header, thru-hole 0.1	3M		
Shunt	7		Sullins	QPC02SXGN-RC	Digi-Key S9337-ND or A26229-ND
Crystal	1	25 MHz Crystal	Abracon		
Crystal Receptacles	2	Pin Receptacle, Amp, .140 lg, Max pin .021 Tin, Gold	Mill-Max	0462-0-15-01-11-02-04-0	Digi-Key 0462-015011102040-ND
Stand-off	4	Standoff, 4-40 1/4 × 5/8	Keystone	1808	Digi-Key 1808K-ND
Screw	4	Screw, 4-40 × 0.25, PHP	Building Fasteners	PMS 440 0025 PH	Digi-Key H342-ND
Evaluation Board	1	NB3M8T3910GEVB QFN-48 Evaluation Board	ON Semiconductor	NB3M8T3910GEVB	
Device Under Test	1	DUT	ON Semiconductor	NB3M8T3910G	www.onsemi.com

NOTE: Components are available through most distributors, i.e. www.newark.com, www.Digikey.com

NB3M8T3910GEVB

ON Semiconductor and the  are registered trademarks of Semiconductor Components Industries, LLC (SCILLC) or its subsidiaries in the United States and/or other countries. SCILLC owns the rights to a number of patents, trademarks, copyrights, trade secrets, and other intellectual property. A listing of SCILLC's product/patent coverage may be accessed at www.onsemi.com/site/pdf/Patent-Marking.pdf. SCILLC reserves the right to make changes without further notice to any products herein. SCILLC makes no warranty, representation or guarantee regarding the suitability of its products for any particular purpose, nor does SCILLC assume any liability arising out of the application or use of any product or circuit, and specifically disclaims any and all liability, including without limitation special, consequential or incidental damages. "Typical" parameters which may be provided in SCILLC data sheets and/or specifications can and do vary in different applications and actual performance may vary over time. All operating parameters, including "Typicals" must be validated for each customer application by customer's technical experts. SCILLC does not convey any license under its patent rights nor the rights of others. SCILLC products are not designed, intended, or authorized for use as components in systems intended for surgical implant into the body, or other applications intended to support or sustain life, or for any other application in which the failure of the SCILLC product could create a situation where personal injury or death may occur. Should Buyer purchase or use SCILLC products for any such unintended or unauthorized application, Buyer shall indemnify and hold SCILLC and its officers, employees, subsidiaries, affiliates, and distributors harmless against all claims, costs, damages, and expenses, and reasonable attorney fees arising out of, directly or indirectly, any claim of personal injury or death associated with such unintended or unauthorized use, even if such claim alleges that SCILLC was negligent regarding the design or manufacture of the part. SCILLC is an Equal Opportunity/Affirmative Action Employer. This literature is subject to all applicable copyright laws and is not for resale in any manner.

PUBLICATION ORDERING INFORMATION

LITERATURE FULFILLMENT:

Literature Distribution Center for ON Semiconductor
P.O. Box 5163, Denver, Colorado 80217 USA
Phone: 303-675-2175 or 800-344-3860 Toll Free USA/Canada
Fax: 303-675-2176 or 800-344-3867 Toll Free USA/Canada
Email: orderlit@onsemi.com

N. American Technical Support: 800-282-9855 Toll Free
USA/Canada
Europe, Middle East and Africa Technical Support:
Phone: 421 33 790 2910
Japan Customer Focus Center
Phone: 81-3-5817-1050

ON Semiconductor Website: www.onsemi.com
Order Literature: <http://www.onsemi.com/orderlit>
For additional information, please contact your local
Sales Representative

EVBUM2238/D

Компания «Life Electronics» занимается поставками электронных компонентов импортного и отечественного производства от производителей и со складов крупных дистрибьюторов Европы, Америки и Азии.

С конца 2013 года компания активно расширяет линейку поставок компонентов по направлению коаксиальный кабель, кварцевые генераторы и конденсаторы (керамические, пленочные, электролитические), за счёт заключения дистрибьюторских договоров

Мы предлагаем:

- Конкурентоспособные цены и скидки постоянным клиентам.
- Специальные условия для постоянных клиентов.
- Подбор аналогов.
- Поставку компонентов в любых объемах, удовлетворяющих вашим потребностям.
- Приемлемые сроки поставки, возможна ускоренная поставка.
- Доставку товара в любую точку России и стран СНГ.
- Комплексную поставку.
- Работу по проектам и поставку образцов.
- Формирование склада под заказчика.
- Сертификаты соответствия на поставляемую продукцию (по желанию клиента).
- Тестирование поставляемой продукции.
- Поставку компонентов, требующих военную и космическую приемку.
- Входной контроль качества.
- Наличие сертификата ISO.

В составе нашей компании организован Конструкторский отдел, призванный помогать разработчикам, и инженерам.

Конструкторский отдел помогает осуществить:

- Регистрацию проекта у производителя компонентов.
- Техническую поддержку проекта.
- Защиту от снятия компонента с производства.
- Оценку стоимости проекта по компонентам.
- Изготовление тестовой платы монтаж и пусконаладочные работы.



Тел: +7 (812) 336 43 04 (многоканальный)

Email: org@lifeelectronics.ru