

**NPN Silicon RF Transistor**

- Low noise amplifier for low current applications
- Collector design supports 5V supply voltage
- For oscillators up to 3.5 GHz
- Low noise figure 1.0 dB at 1.8 GHz
- Pb-free (RoHS compliant) package
- Qualified according AEC Q101

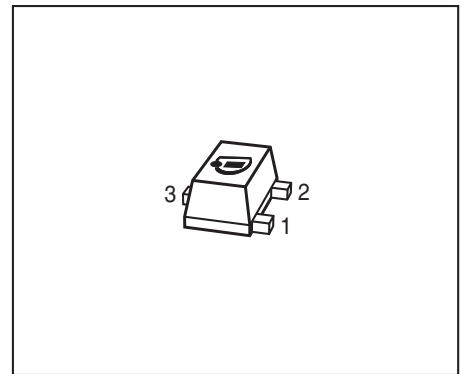

**ESD (Electrostatic discharge) sensitive device, observe handling precaution!**

Type	Marking	Pin Configuration			Package
BFR360F	FBs	1 = B	2 = E	3 = C	TSFP-3

**Maximum Ratings** at  $T_A = 25\text{ °C}$ , unless otherwise specified

Parameter	Symbol	Value	Unit
Collector-emitter voltage	$V_{CEO}$	6	V
Collector-emitter voltage	$V_{CES}$	15	
Collector-base voltage	$V_{CBO}$	15	
Emitter-base voltage	$V_{EBO}$	2	
Collector current	$I_C$	35	mA
Base current	$I_B$	4	
Total power dissipation <sup>1)</sup> $T_S \leq 98\text{ °C}$	$P_{tot}$	210	mW
Junction temperature	$T_J$	150	°C
Storage temperature	$T_{Stg}$	-55 ... 150	

**Thermal Resistance**

Parameter	Symbol	Value	Unit
Junction - soldering point <sup>2)</sup>	$R_{thJS}$	$\leq 250$	K/W

<sup>1)</sup>  $T_S$  is measured on the collector lead at the soldering point to the pcb

<sup>2)</sup> For calculation of  $R_{thJA}$  please refer to Application Note AN077 Thermal Resistance

**Electrical Characteristics** at  $T_A = 25^\circ\text{C}$ , unless otherwise specified

Parameter	Symbol	Values			Unit
		min.	typ.	max.	
<b>DC Characteristics</b>					
Collector-emitter breakdown voltage $I_C = 1\text{ mA}, I_B = 0$	$V_{(BR)CEO}$	6	9	-	V
Collector-emitter cutoff current $V_{CE} = 4\text{ V}, V_{BE} = 0$ $V_{CE} = 10\text{ V}, V_{BE} = 0, T_A = 85^\circ\text{C}$ Verified by random sampling	$I_{CES}$	-	1	30	nA
		-	2	50	
Collector-base cutoff current $V_{CB} = 4\text{ V}, I_E = 0$	$I_{CBO}$	-	1	30	
Emitter-base cutoff current $V_{EB} = 1\text{ V}, I_C = 0$	$I_{EBO}$	-	1	500	
DC current gain $I_C = 15\text{ mA}, V_{CE} = 3\text{ V}$ , pulse measured	$h_{FE}$	90	120	160	-

**Electrical Characteristics at  $T_A = 25^\circ\text{C}$ , unless otherwise specified**

Parameter	Symbol	Values			Unit
		min.	typ.	max.	
<b>AC Characteristics (verified by random sampling)</b>					
Transition frequency $I_C = 15\text{ mA}$ , $V_{CE} = 3\text{ V}$ , $f = 1\text{ GHz}$	$f_T$	11	14	-	GHz
Collector-base capacitance $V_{CB} = 5\text{ V}$ , $f = 1\text{ MHz}$ , $V_{BE} = 0$ , emitter grounded	$C_{cb}$	-	0.32	0.5	pF
Collector emitter capacitance $V_{CE} = 5\text{ V}$ , $f = 1\text{ MHz}$ , $V_{BE} = 0$ , base grounded	$C_{ce}$	-	0.2	-	
Emitter-base capacitance $V_{EB} = 0.5\text{ V}$ , $f = 1\text{ MHz}$ , $V_{CB} = 0$ , collector grounded	$C_{eb}$	-	0.4	-	
Minimum noise figure $I_C = 3\text{ mA}$ , $V_{CE} = 3\text{ V}$ , $Z_S = Z_{Sopt}$ , $f = 1.8\text{ GHz}$	$NF_{min}$	-	1	-	dB
Power gain, maximum available <sup>1)</sup> $I_C = 15\text{ mA}$ , $V_{CE} = 3\text{ V}$ , $Z_S = Z_{Sopt}$ , $Z_L = Z_{Lopt}$ , $f = 1.8\text{ GHz}$ $f = 3\text{ GHz}$	$G_{ma}$	- -	15.5 11	- -	
Transducer gain $I_C = 15\text{ mA}$ , $V_{CE} = 3\text{ V}$ , $Z_S = Z_L = 50\Omega$ , $f = 1.8\text{ GHz}$ $f = 3\text{ GHz}$	$ S_{21e} ^2$	- -	13 9	- -	dB
Third order intercept point at output <sup>2)</sup> $V_{CE} = 3\text{ V}$ , $I_C = 15\text{ mA}$ , $f = 1.8\text{ GHz}$ , $Z_S = Z_L = 50\Omega$	$IP_3$	-	24	-	dBm
1dB compression point at output $I_C = 15\text{ mA}$ , $V_{CE} = 3\text{ V}$ , $Z_S = Z_L = 50\Omega$ , $f = 1.8\text{ GHz}$	$P_{-1dB}$	-	9	-	

$$^1G_{ma} = |S_{21e}| / |S_{12e}| (k - (k^2 - 1)^{1/2})$$

<sup>2)</sup>IP3 value depends on termination of all intermodulation frequency components.  
Termination used for this measurement is  $50\Omega$  from 0.1 MHz to 6 GHz

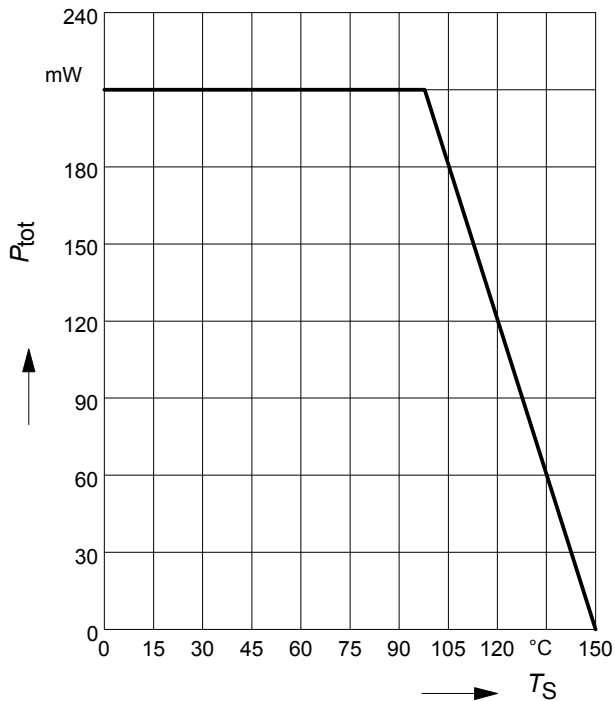
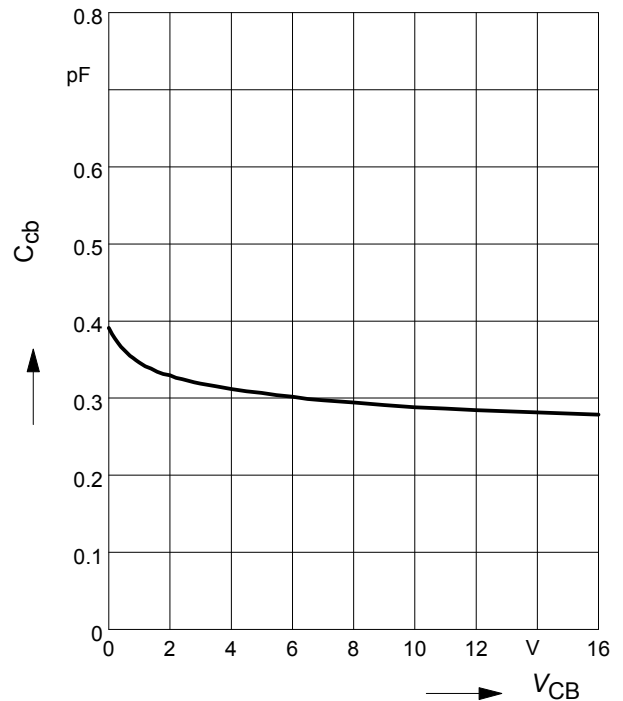
**Total power dissipation  $P_{tot} = f(T_S)$** 

**Collector-base capacitance  $C_{cb} = f(V_{CB})$   
 $f = 1\text{MHz}$** 

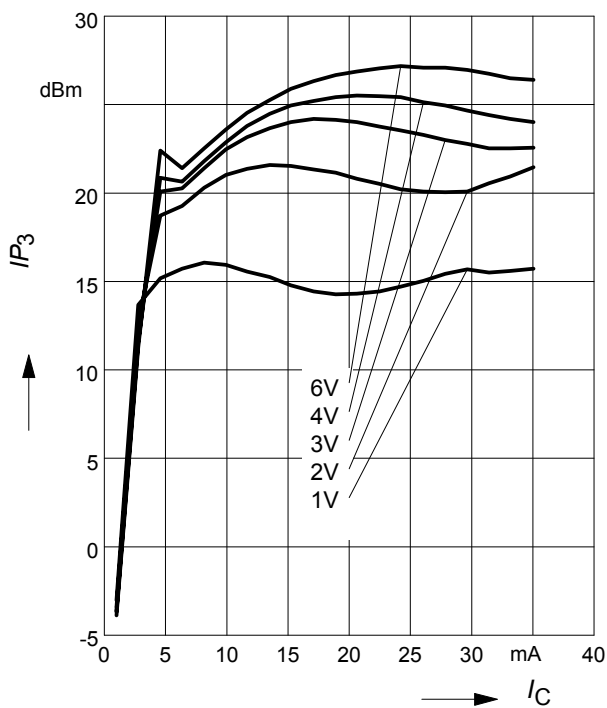
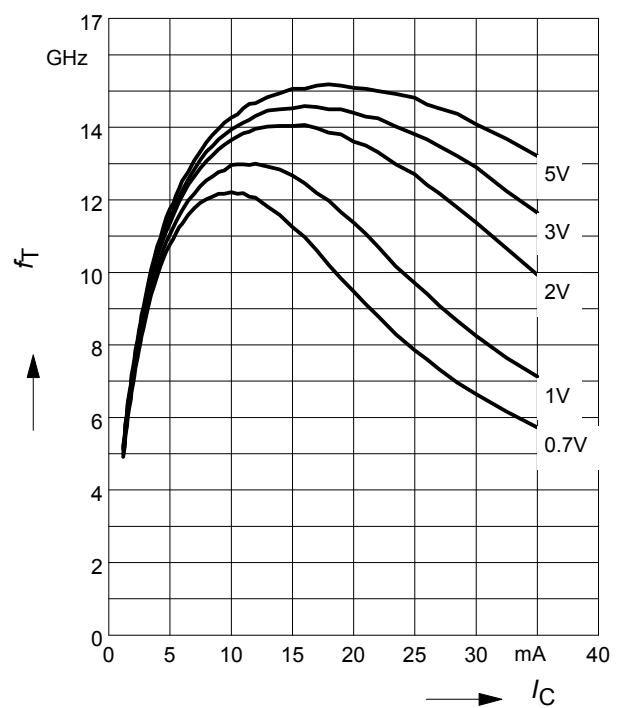
**Third order Intercept Point  $IP_3 = f(I_C)$** 

 (Output,  $Z_S = Z_L = 50\Omega$ )

 $V_{CE} = \text{parameter}, f = 1.8\text{GHz}$ 

**Transition frequency  $f_T = f(I_C)$** 
 $f = 1\text{GHz}$ 
 $V_{CE} = \text{parameter}$ 

**Power gain  $G_{ma}$ ,  $G_{ms} = f(I_C)$**

$f = 0.9\text{GHz}$

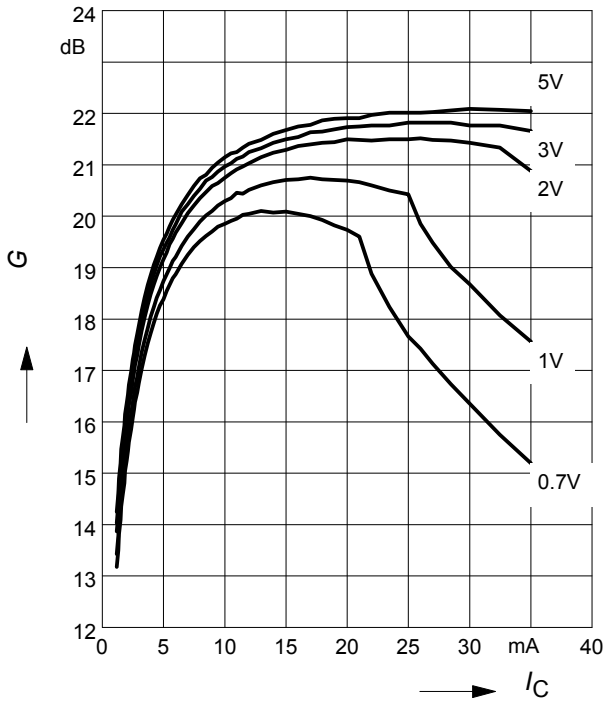
$V_{CE} = \text{parameter}$



**Power gain  $G_{ma}$ ,  $G_{ms} = f(I_C)$**

$f = 1.8\text{GHz}$

$V_{CE} = \text{parameter}$

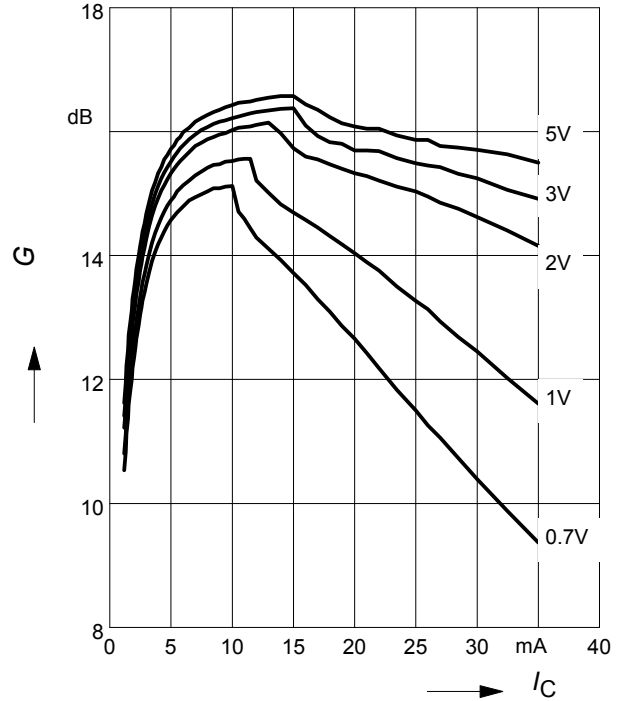

**Power Gain  $G_{ma}$ ,  $G_{ms} = f(f)$**

$V_{CE} = \text{parameter}$

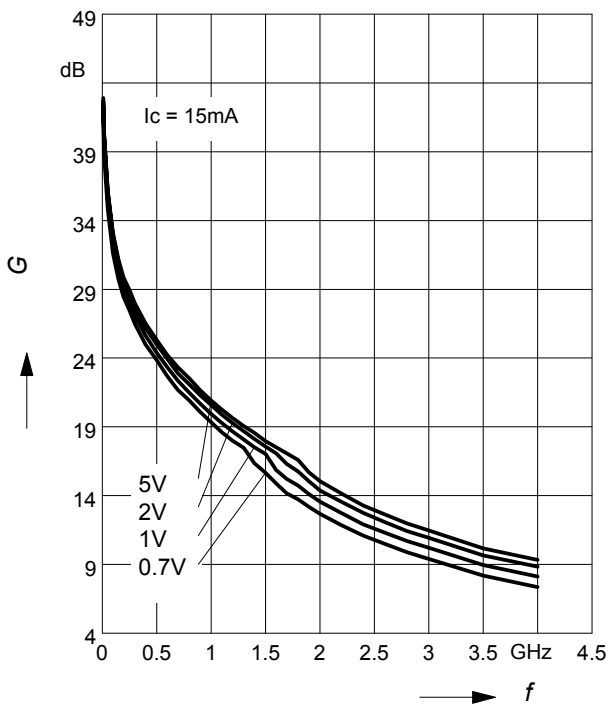

**Insertion Power Gain  $|S_{21}|^2 = f(f)$**

$V_{CE} = \text{parameter}$

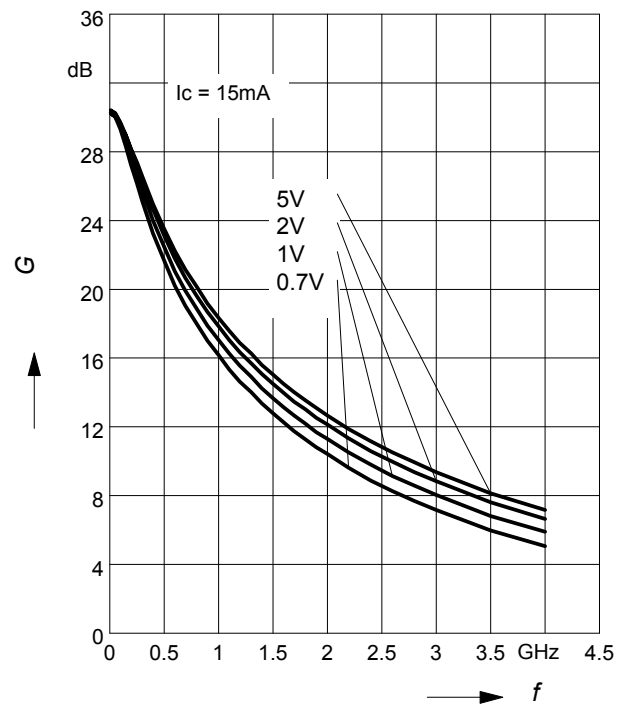

**Power Gain  $G_{ma}$ ,  $G_{ms} = f(V_{CE})$ :** —

$|S_{21}|^2 = f(V_{CE})$ : - - - -

$f =$  parameter

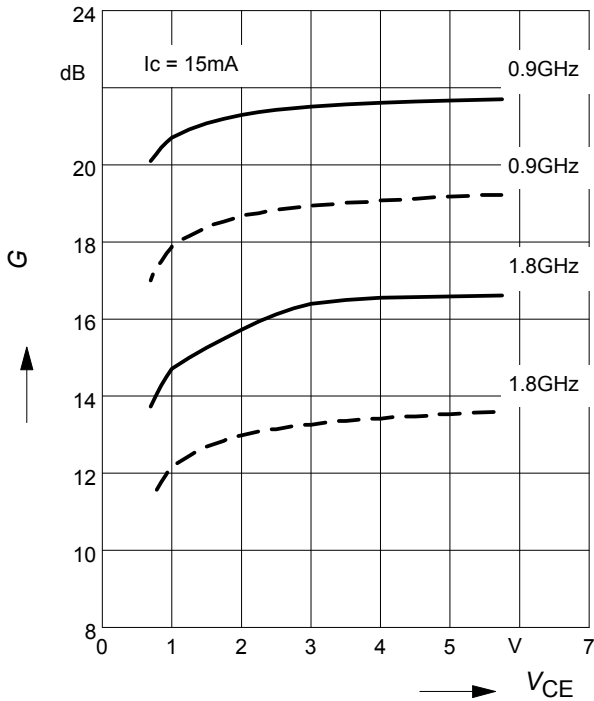

**Power gain  $G_{ma}$ ,  $G_{ms} = f(I_C)$**

$V_{CE} = 3V$

$f =$  parameter

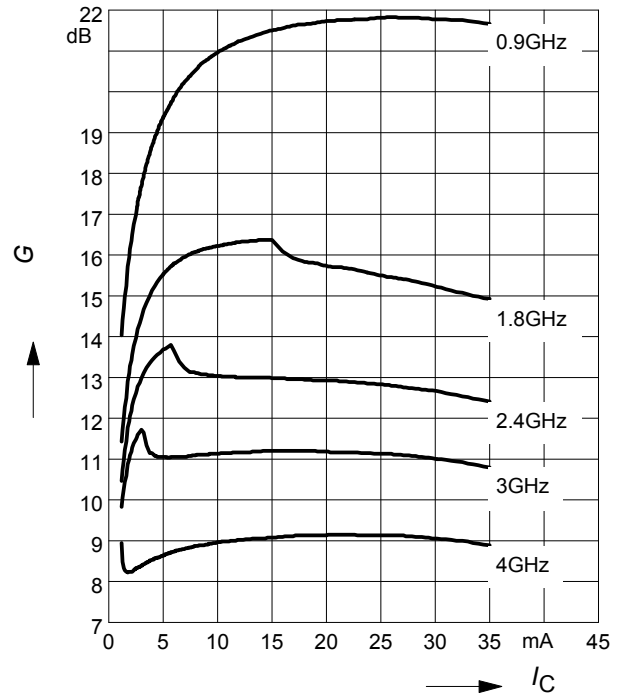

**Noise figure  $NF = f(I_C)$**

$V_{CE} = 3V, f = 1,8 \text{ GHz}$

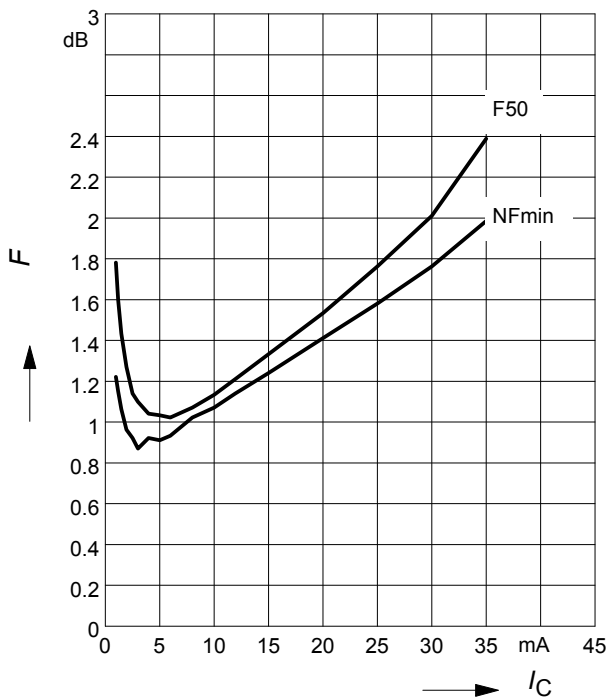

**Noise figure  $F = f(f)$**

$V_{CE} = 3V, Z_S = Z_{Sopt}$

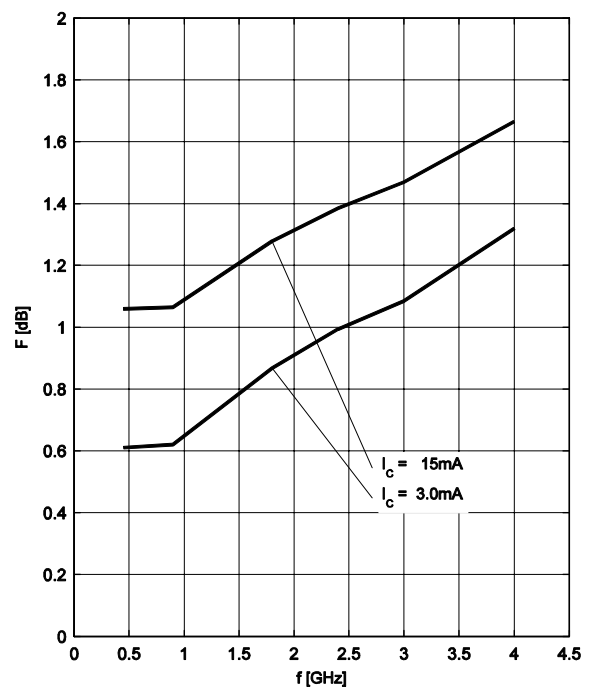

**Source impedance** for min.

noise figure vs. frequency

$V_{CE} = 3\text{ V}$

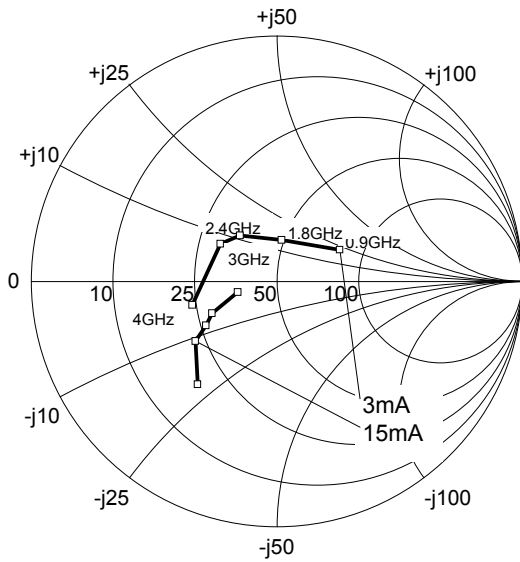

**SPICE Parameter**

For the SPICE model as well as for the S-parameters (including noise parameters) please refer to our internet website [www.infineon.com/rf.models](http://www.infineon.com/rf.models).



Package Outline

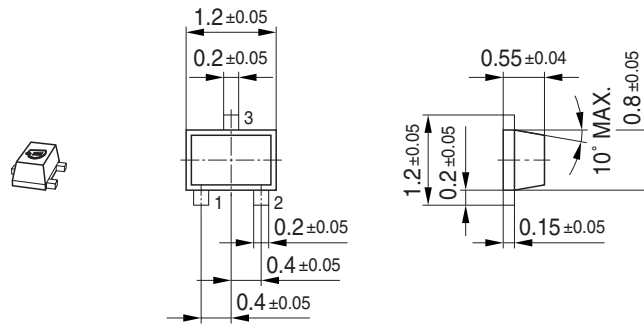

Foot Print

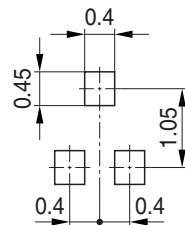

Marking Layout (Example)

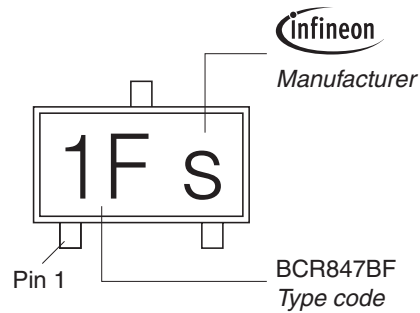

Standard Packing

Reel  $\varnothing$ 180 mm = 3.000 Pieces/Reel  
 Reel  $\varnothing$ 330 mm = 10.000 Pieces/Reel



**Datasheet Revision History: 20 May 2010**

This datasheet replaces the revision from 30 March 2007.

The product itself has not been changed and the device characteristics remain unchanged. Only the product description and information available in the datasheet has been expanded and updated.

<b>Previous Revision: 30 March 2007</b>	
<b>Page</b>	<b>Subject (changes since last revision)</b>
1	Datasheet has final status
1	Max. ratings refer to 25°C
1	Max. rating for $T_A$ removed
1	Lower max. rating for storage temperature $T_{Stg}$ changed
2	Typical values for leakage currents included, maximum leakage current values reduced
6	Characteristic curve for NFmin vs. frequency included

**Edition 2009-11-16**

**Published by  
Infineon Technologies AG  
81726 Munich, Germany**

**© 2009 Infineon Technologies AG  
All Rights Reserved.**

### **Legal Disclaimer**

The information given in this document shall in no event be regarded as a guarantee of conditions or characteristics. With respect to any examples or hints given herein, any typical values stated herein and/or any information regarding the application of the device, Infineon Technologies hereby disclaims any and all warranties and liabilities of any kind, including without limitation, warranties of non-infringement of intellectual property rights of any third party.

### **Information**

For further information on technology, delivery terms and conditions and prices, please contact the nearest Infineon Technologies Office ( [<www.infineon.com>](http://www.infineon.com) ).

### **Warnings**

Due to technical requirements, components may contain dangerous substances. For information on the types in question, please contact the nearest Infineon Technologies Office.

Infineon Technologies components may be used in life-support devices or systems only with the express written approval of Infineon Technologies, if a failure of such components can reasonably be expected to cause the failure of that life-support device or system or to affect the safety or effectiveness of that device or system. Life support devices or systems are intended to be implanted in the human body or to support and/or maintain and sustain and/or protect human life. If they fail, it is reasonable to assume that the health of the user or other persons may be endangered.

Компания «Life Electronics» занимается поставками электронных компонентов импортного и отечественного производства от производителей и со складов крупных дистрибьюторов Европы, Америки и Азии.

С конца 2013 года компания активно расширяет линейку поставок компонентов по направлению коаксиальный кабель, кварцевые генераторы и конденсаторы (керамические, пленочные, электролитические), за счёт заключения дистрибьюторских договоров

Мы предлагаем:

- Конкурентоспособные цены и скидки постоянным клиентам.
- Специальные условия для постоянных клиентов.
- Подбор аналогов.
- Поставку компонентов в любых объемах, удовлетворяющих вашим потребностям.
- Приемлемые сроки поставки, возможна ускоренная поставка.
- Доставку товара в любую точку России и стран СНГ.
- Комплексную поставку.
- Работу по проектам и поставку образцов.
- Формирование склада под заказчика.
- Сертификаты соответствия на поставляемую продукцию (по желанию клиента).
- Тестирование поставляемой продукции.
- Поставку компонентов, требующих военную и космическую приемку.
- Входной контроль качества.
- Наличие сертификата ISO.

В составе нашей компании организован Конструкторский отдел, призванный помогать разработчикам, и инженерам.

Конструкторский отдел помогает осуществить:

- Регистрацию проекта у производителя компонентов.
- Техническую поддержку проекта.
- Защиту от снятия компонента с производства.
- Оценку стоимости проекта по компонентам.
- Изготовление тестовой платы монтаж и пусконаладочные работы.



Тел: +7 (812) 336 43 04 (многоканальный)  
Email: [org@lifeelectronics.ru](mailto:org@lifeelectronics.ru)