

# Trimmer Potentiometers



## Lead Sealed Type Multi-turns PV12/PV37/PV23/PV22/PV36 Series

### PV12 Series

#### ■ Features

1. The unique inner gear system recognizes the position of the center of the shaft of the potentiometer.
2. Sealed construction protects the interior from dust and liquid, which achieves stable performance.
3. Available for ultrasonic cleaning after soldering
4. Clutch mechanism prevents excessive wiper rotation.

#### ■ Applications

1. HDTVs
2. Professional cameras
3. CATV
4. FAX
5. Printers
6. Sensors
7. Switching power supplies



PV12H



PV12P



PV12S



PV12T



| Part Number | Power Rating | Soldering Method    | Number of Turns<br>(Effective Rotation Angle) | Total Resistance Value | TCR        |
|-------------|--------------|---------------------|---|------------------------|------------|
| PV12□100A01 | 0.5W(70°C)   | Flow/Soldering Iron | 4   | 10ohm ±10%             | ±100ppm/°C |
| PV12□200A01 | 0.5W(70°C)   | Flow/Soldering Iron | 4   | 20ohm ±10%             | ±100ppm/°C |
| PV12□500A01 | 0.5W(70°C)   | Flow/Soldering Iron | 4   | 50ohm ±10%             | ±100ppm/°C |
| PV12□101A01 | 0.5W(70°C)   | Flow/Soldering Iron | 4   | 100ohm ±10%            | ±100ppm/°C |
| PV12□201A01 | 0.5W(70°C)   | Flow/Soldering Iron | 4   | 200ohm ±10%            | ±100ppm/°C |
| PV12□501A01 | 0.5W(70°C)   | Flow/Soldering Iron | 4   | 500ohm ±10%            | ±100ppm/°C |
| PV12□102A01 | 0.5W(70°C)   | Flow/Soldering Iron | 4   | 1k ohm ±10%            | ±100ppm/°C |
| PV12□202A01 | 0.5W(70°C)   | Flow/Soldering Iron | 4   | 2k ohm ±10%            | ±100ppm/°C |
| PV12□502A01 | 0.5W(70°C)   | Flow/Soldering Iron | 4   | 5k ohm ±10%            | ±100ppm/°C |
| PV12□103A01 | 0.5W(70°C)   | Flow/Soldering Iron | 4   | 10k ohm ±10%           | ±100ppm/°C |

Continued on the following page.

Continued from the preceding page.

| Part Number | Power Rating | Soldering Method    | Number of Turns<br>(Effective Rotation Angle) | Total Resistance Value | TCR        |
|-------------|--------------|---------------------|---|------------------------|------------|
| PV12□203A01 | 0.5W(70°C)   | Flow/Soldering Iron | 4   | 20k ohm ±10%           | ±100ppm/°C |
| PV12□503A01 | 0.5W(70°C)   | Flow/Soldering Iron | 4   | 50k ohm ±10%           | ±100ppm/°C |
| PV12□104A01 | 0.5W(70°C)   | Flow/Soldering Iron | 4   | 100k ohm ±10%          | ±100ppm/°C |
| PV12□204A01 | 0.5W(70°C)   | Flow/Soldering Iron | 4   | 200k ohm ±10%          | ±100ppm/°C |
| PV12□504A01 | 0.5W(70°C)   | Flow/Soldering Iron | 4   | 500k ohm ±10%          | ±100ppm/°C |
| PV12□105A01 | 0.5W(70°C)   | Flow/Soldering Iron | 4   | 1M ohm ±10%            | ±100ppm/°C |
| PV12□205A01 | 0.5W(70°C)   | Flow/Soldering Iron | 4   | 2M ohm ±10%            | ±100ppm/°C |

Operating Temperature Range: -55 to 125 °C

The blank column is filled with the code of adjustment direction and lead type (H, P, T and S).

The order quantity should be an integral multiple of the "Minimum Quantity".

## Construction



## Mounting Holes

PV12H



(Tolerance:±0.1  
in mm)

PV12P/PV12S



(Tolerance:±0.1  
in mm)

PV12T



(Tolerance:±0.1  
in mm)

## ■ Characteristics

|                              |                 |              |
|------------------------------|-----------------|--------------|
| Temperature Cycle            | $\Delta$ TR     | $\pm 2\%$    |
|                              | $\Delta$ V.S.S. | $\pm 1\%$    |
| Humidity                     | $\Delta$ TR     | $\pm 2\%$    |
|                              | IR              | 100Mohm min. |
| Vibration (20G)              | $\Delta$ TR     | $\pm 1\%$    |
|                              | $\Delta$ V.S.S. | $\pm 1\%$    |
| Shock (100G)                 | $\Delta$ TR     | $\pm 1\%$    |
|                              | $\Delta$ V.S.S. | $\pm 1\%$    |
| Temperature Load Life        | $\Delta$ TR     | $\pm 3\%$    |
|                              | $\Delta$ V.S.S. | $\pm 2\%$    |
| Low Temperature Exposure     | $\Delta$ TR     | $\pm 3\%$    |
|                              | $\Delta$ V.S.S. | $\pm 1.5\%$  |
| High Temperature Exposure    | $\Delta$ TR     | $\pm 3\%$    |
|                              | $\Delta$ V.S.S. | $\pm 1.5\%$  |
| Rotational Life (200 cycles) | $\Delta$ TR     | $\pm 3\%$    |

$\Delta$ TR : Total Resistance Change  
 $\Delta$ V.S.S. : Voltage Setting Stability  
 IR : Insulation Resistance

## PV37 Series

### ■ Features

1. Smaller volume (about one-third) than 25-turns potentiometer
2. Sealed construction protects the interior from dust and liquid, which achieves stable performance.
3. Available for ultrasonic cleaning after soldering
4. Clutch mechanism prevents excessive wiper rotation.
5. 5 standard terminal styles
6. Both Top and side adjustment directions
7. To be complied with RoHS directive by new Cd free cermet resistive material. Pb free terminals with Sn plating.

### ■ Applications

1. Measuring instruments
2. OA equipment
3. Medical equipment
4. Power supply
5. Base station for cellular phone



PV37P



PV37W



PV37X



PV37Y



PV37Z



| Part Number | Power Rating | Soldering Method    | Number of Turns (Effective Rotation Angle) | Total Resistance Value | TCR        |
|-------------|--------------|---------------------|--|------------------------|------------|
| PV37□100C01 | 0.25W(85°C)  | Flow/Soldering Iron | 12   | 10ohm ±10%             | ±150ppm/°C |
| PV37□200C01 | 0.25W(85°C)  | Flow/Soldering Iron | 12   | 20ohm ±10%             | ±150ppm/°C |
| PV37□500C01 | 0.25W(85°C)  | Flow/Soldering Iron | 12   | 50ohm ±10%             | ±150ppm/°C |

Continued on the following page.

Continued from the preceding page.

| Part Number | Power Rating | Soldering Method    | Number of Turns<br>(Effective Rotation Angle) | Total Resistance Value | TCR        |
|-------------|--------------|---------------------|---|------------------------|------------|
| PV37□101C01 | 0.25W(85°C)  | Flow/Soldering Iron | 12  | 100ohm ±10%            | ±150ppm/°C |
| PV37□201C01 | 0.25W(85°C)  | Flow/Soldering Iron | 12  | 200ohm ±10%            | ±150ppm/°C |
| PV37□501C01 | 0.25W(85°C)  | Flow/Soldering Iron | 12  | 500ohm ±10%            | ±150ppm/°C |
| PV37□102C01 | 0.25W(85°C)  | Flow/Soldering Iron | 12  | 1k ohm ±10%            | ±150ppm/°C |
| PV37□202C01 | 0.25W(85°C)  | Flow/Soldering Iron | 12  | 2k ohm ±10%            | ±150ppm/°C |
| PV37□502C01 | 0.25W(85°C)  | Flow/Soldering Iron | 12  | 5k ohm ±10%            | ±150ppm/°C |
| PV37□103C01 | 0.25W(85°C)  | Flow/Soldering Iron | 12  | 10k ohm ±10%           | ±150ppm/°C |
| PV37□203C01 | 0.25W(85°C)  | Flow/Soldering Iron | 12  | 20k ohm ±10%           | ±150ppm/°C |
| PV37□253C01 | 0.25W(85°C)  | Flow/Soldering Iron | 12  | 25k ohm ±10%           | ±150ppm/°C |
| PV37□503C01 | 0.25W(85°C)  | Flow/Soldering Iron | 12  | 50k ohm ±10%           | ±150ppm/°C |
| PV37□104C01 | 0.25W(85°C)  | Flow/Soldering Iron | 12  | 100k ohm ±10%          | ±150ppm/°C |
| PV37□204C01 | 0.25W(85°C)  | Flow/Soldering Iron | 12  | 200k ohm ±10%          | ±150ppm/°C |
| PV37□254C01 | 0.25W(85°C)  | Flow/Soldering Iron | 12  | 250k ohm ±10%          | ±150ppm/°C |
| PV37□504C01 | 0.25W(85°C)  | Flow/Soldering Iron | 12  | 500k ohm ±10%          | ±150ppm/°C |
| PV37□105C01 | 0.25W(85°C)  | Flow/Soldering Iron | 12  | 1M ohm ±10%            | ±150ppm/°C |
| PV37□205C01 | 0.25W(85°C)  | Flow/Soldering Iron | 12  | 2M ohm ±10%            | ±150ppm/°C |
| PV37□100C31 | 0.25W(85°C)  | Flow/Soldering Iron | 12  | 10ohm ±10%             | ±150ppm/°C |
| PV37□200C31 | 0.25W(85°C)  | Flow/Soldering Iron | 12  | 20ohm ±10%             | ±150ppm/°C |
| PV37□500C31 | 0.25W(85°C)  | Flow/Soldering Iron | 12  | 50ohm ±10%             | ±150ppm/°C |
| PV37□101C31 | 0.25W(85°C)  | Flow/Soldering Iron | 12  | 100ohm ±10%            | ±150ppm/°C |
| PV37□201C31 | 0.25W(85°C)  | Flow/Soldering Iron | 12  | 200ohm ±10%            | ±150ppm/°C |
| PV37□501C31 | 0.25W(85°C)  | Flow/Soldering Iron | 12  | 500ohm ±10%            | ±150ppm/°C |
| PV37□102C31 | 0.25W(85°C)  | Flow/Soldering Iron | 12  | 1k ohm ±10%            | ±150ppm/°C |
| PV37□202C31 | 0.25W(85°C)  | Flow/Soldering Iron | 12  | 2k ohm ±10%            | ±150ppm/°C |
| PV37□502C31 | 0.25W(85°C)  | Flow/Soldering Iron | 12  | 5k ohm ±10%            | ±150ppm/°C |
| PV37□103C31 | 0.25W(85°C)  | Flow/Soldering Iron | 12  | 10k ohm ±10%           | ±150ppm/°C |
| PV37□203C31 | 0.25W(85°C)  | Flow/Soldering Iron | 12  | 20k ohm ±10%           | ±150ppm/°C |
| PV37□253C31 | 0.25W(85°C)  | Flow/Soldering Iron | 12  | 25k ohm ±10%           | ±150ppm/°C |
| PV37□503C31 | 0.25W(85°C)  | Flow/Soldering Iron | 12  | 50k ohm ±10%           | ±150ppm/°C |
| PV37□104C31 | 0.25W(85°C)  | Flow/Soldering Iron | 12  | 100k ohm ±10%          | ±150ppm/°C |
| PV37□204C31 | 0.25W(85°C)  | Flow/Soldering Iron | 12  | 200k ohm ±10%          | ±150ppm/°C |
| PV37□254C31 | 0.25W(85°C)  | Flow/Soldering Iron | 12  | 250k ohm ±10%          | ±150ppm/°C |
| PV37□504C31 | 0.25W(85°C)  | Flow/Soldering Iron | 12  | 500k ohm ±10%          | ±150ppm/°C |
| PV37□105C31 | 0.25W(85°C)  | Flow/Soldering Iron | 12  | 1M ohm ±10%            | ±150ppm/°C |
| PV37□205C31 | 0.25W(85°C)  | Flow/Soldering Iron | 12  | 2M ohm ±10%            | ±150ppm/°C |

Operating Temperature Range: -55 to 125 °C

The blank column is filled with the code of adjustment direction and lead type (P, X, Y, W and Z).

The order quantity should be an integral multiple of the "Minimum Quantity".

The last three digits express the individual specification codes. C01 for standard type and C31 for radial taping type (PV37Y/PV37Z series only).

| Part Number | Power Rating (W) | Soldering Method    | Number of Turns (Effective Rotation Angle) | Total Resistance Value | TCR (ppm/°C) | Remarks                            |
|-------------|------------------|---------------------|--|------------------------|--------------|------------------------------------|
| PV37□100A01 | 0.25(85°C)       | Flow/Soldering Iron | 12   | 10 ohm±10%             | ±100         | Non Standard Product (Cd included) |
| PV37□200A01 | 0.25(85°C)       | Flow/Soldering Iron | 12   | 20 ohm±10%             | ±100         |                                    |
| PV37□500A01 | 0.25(85°C)       | Flow/Soldering Iron | 12   | 50 ohm±10%             | ±100         |                                    |
| PV37□101A01 | 0.25(85°C)       | Flow/Soldering Iron | 12   | 100 ohm±10%            | ±100         |                                    |
| PV37□201A01 | 0.25(85°C)       | Flow/Soldering Iron | 12   | 200 ohm±10%            | ±100         |                                    |
| PV37□501A01 | 0.25(85°C)       | Flow/Soldering Iron | 12   | 500 ohm±10%            | ±100         |                                    |
| PV37□102A01 | 0.25(85°C)       | Flow/Soldering Iron | 12   | 1k ohm±10%             | ±100         |                                    |
| PV37□202A01 | 0.25(85°C)       | Flow/Soldering Iron | 12   | 2k ohm±10%             | ±100         |                                    |
| PV37□502A01 | 0.25(85°C)       | Flow/Soldering Iron | 12   | 5k ohm±10%             | ±100         |                                    |
| PV37□103A01 | 0.25(85°C)       | Flow/Soldering Iron | 12   | 10k ohm±10%            | ±100         |                                    |
| PV37□203A01 | 0.25(85°C)       | Flow/Soldering Iron | 12   | 20k ohm±10%            | ±100         |                                    |
| PV37□253A01 | 0.25(85°C)       | Flow/Soldering Iron | 12   | 25k ohm±10%            | ±100         |                                    |
| PV37□503A01 | 0.25(85°C)       | Flow/Soldering Iron | 12   | 50k ohm±10%            | ±100         |                                    |
| PV37□104A01 | 0.25(85°C)       | Flow/Soldering Iron | 12   | 100k ohm±10%           | ±100         |                                    |
| PV37□204A01 | 0.25(85°C)       | Flow/Soldering Iron | 12   | 200k ohm±10%           | ±100         |                                    |
| PV37□254A01 | 0.25(85°C)       | Flow/Soldering Iron | 12   | 250k ohm±10%           | ±100         |                                    |
| PV37□504A01 | 0.25(85°C)       | Flow/Soldering Iron | 12   | 500k ohm±10%           | ±100         |                                    |
| PV37□105A01 | 0.25(85°C)       | Flow/Soldering Iron | 12   | 1M ohm±10%             | ±100         |                                    |
| PV37□205A01 | 0.25(85°C)       | Flow/Soldering Iron | 12   | 2M ohm±10%             | ±100         |                                    |
| PV37□100A31 | 0.25(85°C)       | Flow/Soldering Iron | 12   | 10 ohm±10%             | ±100         |                                    |
| PV37□200A31 | 0.25(85°C)       | Flow/Soldering Iron | 12   | 20 ohm±10%             | ±100         |                                    |
| PV37□500A31 | 0.25(85°C)       | Flow/Soldering Iron | 12   | 50 ohm±10%             | ±100         |                                    |
| PV37□101A31 | 0.25(85°C)       | Flow/Soldering Iron | 12   | 100 ohm±10%            | ±100         |                                    |
| PV37□201A31 | 0.25(85°C)       | Flow/Soldering Iron | 12   | 200 ohm±10%            | ±100         |                                    |
| PV37□501A31 | 0.25(85°C)       | Flow/Soldering Iron | 12   | 500 ohm±10%            | ±100         |                                    |
| PV37□102A31 | 0.25(85°C)       | Flow/Soldering Iron | 12   | 1k ohm±10%             | ±100         |                                    |
| PV37□202A31 | 0.25(85°C)       | Flow/Soldering Iron | 12   | 2k ohm±10%             | ±100         |                                    |
| PV37□502A31 | 0.25(85°C)       | Flow/Soldering Iron | 12   | 5k ohm±10%             | ±100         |                                    |
| PV37□103A31 | 0.25(85°C)       | Flow/Soldering Iron | 12   | 10k ohm±10%            | ±100         |                                    |
| PV37□203A31 | 0.25(85°C)       | Flow/Soldering Iron | 12   | 20k ohm±10%            | ±100         |                                    |
| PV37□253A31 | 0.25(85°C)       | Flow/Soldering Iron | 12   | 25k ohm±10%            | ±100         |                                    |
| PV37□503A31 | 0.25(85°C)       | Flow/Soldering Iron | 12   | 50k ohm±10%            | ±100         |                                    |
| PV37□104A31 | 0.25(85°C)       | Flow/Soldering Iron | 12   | 100k ohm±10%           | ±100         |                                    |
| PV37□204A31 | 0.25(85°C)       | Flow/Soldering Iron | 12   | 200k ohm±10%           | ±100         |                                    |
| PV37□254A31 | 0.25(85°C)       | Flow/Soldering Iron | 12   | 250k ohm±10%           | ±100         |                                    |
| PV37□504A31 | 0.25(85°C)       | Flow/Soldering Iron | 12   | 500k ohm±10%           | ±100         |                                    |
| PV37□105A31 | 0.25(85°C)       | Flow/Soldering Iron | 12   | 1M ohm±10%             | ±100         |                                    |
| PV37□205A31 | 0.25(85°C)       | Flow/Soldering Iron | 12   | 2M ohm±10%             | ±100         |                                    |

■ Construction

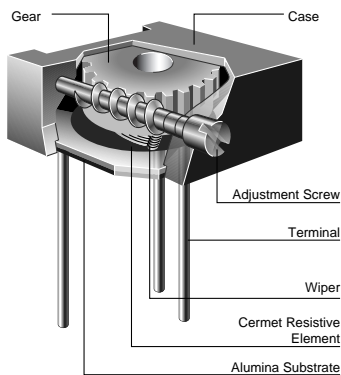

## ■ Mounting Holes

PV37P



(Tolerance:±0.1  
in mm)

PV37W/PV37X



(Tolerance ±0.1  
in mm)

PV37Y/PV37Z



(Tolerance:±0.1  
in mm)

## ■ Characteristics

|                              |                 |                  |
|------------------------------|-----------------|------------------|
| Temperature Cycle            | $\Delta TR$     | ±1%              |
|                              | $\Delta V.S.S.$ | ±1%              |
| Humidity                     | $\Delta TR$     | ±2%              |
|                              | IR              | 100Mohm min.     |
| Vibration (20G)              | $\Delta TR$     | ±1%              |
|                              | $\Delta V.S.S.$ | ±1%              |
| Shock (100G)                 | $\Delta TR$     | ±1%              |
|                              | $\Delta V.S.S.$ | ±1%              |
| Temperature Load Life        | $\Delta TR$     | ±2%              |
|                              | $\Delta V.S.S.$ | ±1%              |
| Low Temperature Exposure     | $\Delta TR$     | ±1%              |
|                              | $\Delta V.S.S.$ | ±1%              |
| High Temperature Exposure    | $\Delta TR$     | ±2%              |
|                              | $\Delta V.S.S.$ | ±1%              |
| Rotational Life (200 cycles) | $\Delta TR$     | R≤100ohm ... ±3% |
|                              |                 | R>100ohm ... ±2% |

$\Delta TR$  : Total Resistance Change  
 $\Delta V.S.S.$  : Voltage Setting Stability  
 IR : Insulation Resistance  
 R : Standard Total Resistance

## PV23 Series

### ■ Features

1. Small size (4.6x6.4x19.1mm) and high power rating (0.75W at 70deg.C)
2. Sealed construction protects the interior from dust and liquid, which achieves stable performance.
3. Available for ultrasonic cleaning after soldering
4. Clutch mechanism prevents excessive wiper rotation.
5. To be complied with RoHS directive by new Cd free cermet resistive material. Pb free terminals with Sn plating.

### ■ Applications

1. Measuring instruments
2. FAX
3. Copier
4. Printers
5. Sensors



PV23P



PV23Y



| Part Number | Power Rating | Soldering Method    | Number of Turns<br>(Effective Rotation Angle) | Total Resistance Value | TCR        |
|-------------|--------------|---------------------|---|------------------------|------------|
| PV23□100C01 | 0.75W(70°C)  | Flow/Soldering Iron | 15  | 10ohm ±10%             | ±150ppm/°C |
| PV23□200C01 | 0.75W(70°C)  | Flow/Soldering Iron | 15  | 20ohm ±10%             | ±150ppm/°C |
| PV23□500C01 | 0.75W(70°C)  | Flow/Soldering Iron | 15  | 50ohm ±10%             | ±150ppm/°C |
| PV23□101C01 | 0.75W(70°C)  | Flow/Soldering Iron | 15  | 100ohm ±10%            | ±150ppm/°C |
| PV23□201C01 | 0.75W(70°C)  | Flow/Soldering Iron | 15  | 200ohm ±10%            | ±100ppm/°C |
| PV23□501C01 | 0.75W(70°C)  | Flow/Soldering Iron | 15  | 500ohm ±10%            | ±100ppm/°C |
| PV23□102C01 | 0.75W(70°C)  | Flow/Soldering Iron | 15  | 1k ohm ±10%            | ±100ppm/°C |
| PV23□202C01 | 0.75W(70°C)  | Flow/Soldering Iron | 15  | 2k ohm ±10%            | ±100ppm/°C |
| PV23□502C01 | 0.75W(70°C)  | Flow/Soldering Iron | 15  | 5k ohm ±10%            | ±100ppm/°C |
| PV23□103C01 | 0.75W(70°C)  | Flow/Soldering Iron | 15  | 10k ohm ±10%           | ±100ppm/°C |
| PV23□203C01 | 0.75W(70°C)  | Flow/Soldering Iron | 15  | 20k ohm ±10%           | ±100ppm/°C |
| PV23□503C01 | 0.75W(70°C)  | Flow/Soldering Iron | 15  | 50k ohm ±10%           | ±100ppm/°C |
| PV23□104C01 | 0.75W(70°C)  | Flow/Soldering Iron | 15  | 100k ohm ±10%          | ±100ppm/°C |
| PV23□204C01 | 0.75W(70°C)  | Flow/Soldering Iron | 15  | 200k ohm ±10%          | ±100ppm/°C |
| PV23□504C01 | 0.75W(70°C)  | Flow/Soldering Iron | 15  | 500k ohm ±10%          | ±100ppm/°C |
| PV23□105C01 | 0.75W(70°C)  | Flow/Soldering Iron | 15  | 1M ohm ±10%            | ±100ppm/°C |
| PV23□205C01 | 0.75W(70°C)  | Flow/Soldering Iron | 15  | 2M ohm ±10%            | ±100ppm/°C |

Operating Temperature Range: -55 to 125 °C

The blank column is filled with the code of adjustment direction and lead type (P and Y).

The order quantity should be an integral multiple of the "Minimum Quantity".



| Part Number | Power Rating (W) | Soldering Method    | Number of Turns (Effective Rotation Angle) | Total Resistance Value | TCR (ppm/°C) | Remarks                            |
|-------------|------------------|---------------------|--|------------------------|--------------|------------------------------------|
| PV23□100A01 | 0.75(70°C)       | Flow/Soldering Iron | 15   | 10 ohm±10%             | ±100         | Non Standard Product (Cd included) |
| PV23□200A01 | 0.75(70°C)       | Flow/Soldering Iron | 15   | 20 ohm±10%             | ±100         |                                    |
| PV23□500A01 | 0.75(70°C)       | Flow/Soldering Iron | 15   | 50 ohm±10%             | ±100         |                                    |
| PV23□101A01 | 0.75(70°C)       | Flow/Soldering Iron | 15   | 100 ohm±10%            | ±100         |                                    |
| PV23□201A01 | 0.75(70°C)       | Flow/Soldering Iron | 15   | 200 ohm±10%            | ±100         |                                    |
| PV23□501A01 | 0.75(70°C)       | Flow/Soldering Iron | 15   | 500 ohm±10%            | ±100         |                                    |
| PV23□102A01 | 0.75(70°C)       | Flow/Soldering Iron | 15   | 1k ohm±10%             | ±100         |                                    |
| PV23□202A01 | 0.75(70°C)       | Flow/Soldering Iron | 15   | 2k ohm±10%             | ±100         |                                    |
| PV23□502A01 | 0.75(70°C)       | Flow/Soldering Iron | 15   | 5k ohm±10%             | ±100         |                                    |
| PV23□103A01 | 0.75(70°C)       | Flow/Soldering Iron | 15   | 10k ohm±10%            | ±100         |                                    |
| PV23□203A01 | 0.75(70°C)       | Flow/Soldering Iron | 15   | 20k ohm±10%            | ±100         |                                    |
| PV23□503A01 | 0.75(70°C)       | Flow/Soldering Iron | 15   | 50k ohm±10%            | ±100         |                                    |
| PV23□104A01 | 0.75(70°C)       | Flow/Soldering Iron | 15   | 100k ohm±10%           | ±100         |                                    |
| PV23□204A01 | 0.75(70°C)       | Flow/Soldering Iron | 15   | 200k ohm±10%           | ±100         |                                    |
| PV23□504A01 | 0.75(70°C)       | Flow/Soldering Iron | 15   | 500k ohm±10%           | ±100         |                                    |
| PV23□105A01 | 0.75(70°C)       | Flow/Soldering Iron | 15   | 1M ohm±10%             | ±100         |                                    |
| PV23□205A01 | 0.75(70°C)       | Flow/Soldering Iron | 15   | 2M ohm±10%             | ±100         |                                    |

### ■ Construction



### ■ Mounting Holes

PV23P



(Tolerance:±0.1 in mm)

PV23Y



(Tolerance:±0.1 in mm)

## ■ Characteristics

|                              |                 |              |
|------------------------------|-----------------|--------------|
| Temperature Cycle            | $\Delta$ TR     | $\pm 2\%$    |
|                              | $\Delta$ V.S.S. | $\pm 1\%$    |
| Humidity                     | $\Delta$ TR     | $\pm 2\%$    |
|                              | IR              | 100Mohm min. |
| Vibration (20G)              | $\Delta$ TR     | $\pm 1\%$    |
|                              | $\Delta$ V.S.S. | $\pm 1\%$    |
| Shock (50G)                  | $\Delta$ TR     | $\pm 1\%$    |
|                              | $\Delta$ V.S.S. | $\pm 1\%$    |
| Temperature Load Life        | $\Delta$ TR     | $\pm 3\%$    |
|                              | $\Delta$ V.S.S. | $\pm 1\%$    |
| Low Temperature Exposure     | $\Delta$ TR     | $\pm 1\%$    |
|                              | $\Delta$ V.S.S. | $\pm 1\%$    |
| High Temperature Exposure    | $\Delta$ TR     | $\pm 2\%$    |
|                              | $\Delta$ V.S.S. | $\pm 1\%$    |
| Rotational Life (200 cycles) | $\Delta$ TR     | $\pm 3\%$    |

$\Delta$ TR : Total Resistance Change  
 $\Delta$ V.S.S. : Voltage Setting Stability  
 IR : Insulation Resistance

## PV22 Series

### ■ Features

1. High power rating (1W at 70 deg.C)
2. Sealed construction protects the interior from dust and liquid, which achieves stable performance.
3. Available for ultrasonic cleaning after soldering
4. Clutch mechanism prevents excessive wiper rotation.
5. To be complied with RoHS directive by new Cd free cermet resistive material. Pb free terminals with Sn plating.

### ■ Applications

1. Measuring instruments
2. FAX
3. Copier
4. Printers
5. Sensors



PV22L



PV22S

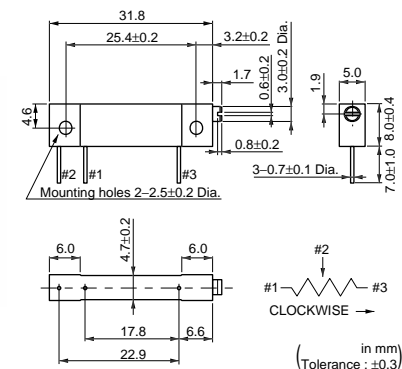

PV22Y

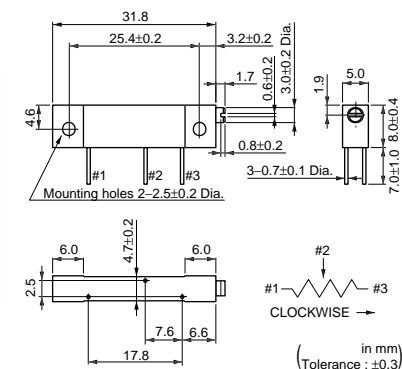

| Part Number | Power Rating | Soldering Method    | Number of Turns<br>(Effective Rotation Angle) | Total Resistance Value | TCR        |
|-------------|--------------|---------------------|---|------------------------|------------|
| PV22□100C01 | 1.0W(70°C)   | Flow/Soldering Iron | 22  | 10ohm ±10%             | ±100ppm/°C |
| PV22□200C01 | 1.0W(70°C)   | Flow/Soldering Iron | 22  | 20ohm ±10%             | ±100ppm/°C |
| PV22□500C01 | 1.0W(70°C)   | Flow/Soldering Iron | 22  | 50ohm ±10%             | ±100ppm/°C |
| PV22□101C01 | 1.0W(70°C)   | Flow/Soldering Iron | 22  | 100ohm ±10%            | ±100ppm/°C |
| PV22□201C01 | 1.0W(70°C)   | Flow/Soldering Iron | 22  | 200ohm ±10%            | ±100ppm/°C |
| PV22□501C01 | 1.0W(70°C)   | Flow/Soldering Iron | 22  | 500ohm ±10%            | ±100ppm/°C |
| PV22□102C01 | 1.0W(70°C)   | Flow/Soldering Iron | 22  | 1k ohm ±10%            | ±100ppm/°C |
| PV22□202C01 | 1.0W(70°C)   | Flow/Soldering Iron | 22  | 2k ohm ±10%            | ±100ppm/°C |
| PV22□502C01 | 1.0W(70°C)   | Flow/Soldering Iron | 22  | 5k ohm ±10%            | ±100ppm/°C |
| PV22□103C01 | 1.0W(70°C)   | Flow/Soldering Iron | 22  | 10k ohm ±10%           | ±100ppm/°C |
| PV22□203C01 | 1.0W(70°C)   | Flow/Soldering Iron | 22  | 20k ohm ±10%           | ±100ppm/°C |
| PV22□503C01 | 1.0W(70°C)   | Flow/Soldering Iron | 22  | 50k ohm ±10%           | ±100ppm/°C |
| PV22□104C01 | 1.0W(70°C)   | Flow/Soldering Iron | 22  | 100k ohm ±10%          | ±100ppm/°C |
| PV22□204C01 | 1.0W(70°C)   | Flow/Soldering Iron | 22  | 200k ohm ±10%          | ±100ppm/°C |
| PV22□504C01 | 1.0W(70°C)   | Flow/Soldering Iron | 22  | 500k ohm ±10%          | ±100ppm/°C |
| PV22□105C01 | 1.0W(70°C)   | Flow/Soldering Iron | 22  | 1M ohm ±10%            | ±100ppm/°C |

Continued on the following page. ↗

Continued from the preceding page.

| Part Number | Power Rating | Soldering Method    | Number of Turns<br>(Effective Rotation Angle) | Total Resistance Value | TCR        |
|-------------|--------------|---------------------|---|------------------------|------------|
| PV22□205C01 | 1.0W(70°C)   | Flow/Soldering Iron | 22  | 2M ohm ±10%            | ±100ppm/°C |

Operating Temperature Range: -55 to 150 °C

The blank column is filled with the code of adjustment direction and lead type (L, S and Y).

The order quantity should be an integral multiple of the "Minimum Quantity".

| Part Number | Power Rating<br>(W) | Soldering Method    | Number of Turns<br>(Effective Rotation Angle) | Total Resistance Value | TCR<br>(ppm/°C) | Remarks                                  |
|-------------|---------------------|---------------------|---|------------------------|-----------------|--|
| PV22□100A01 | 1.0(70°C)           | Flow/Soldering Iron | 22  | 10 ohm±10%             | ±100            | Non Standard<br>Product<br>(Cd included) |
| PV22□200A01 | 1.0(70°C)           | Flow/Soldering Iron | 22  | 20 ohm±10%             | ±100            |  |
| PV22□500A01 | 1.0(70°C)           | Flow/Soldering Iron | 22  | 50 ohm±10%             | ±100            |  |
| PV22□101A01 | 1.0(70°C)           | Flow/Soldering Iron | 22  | 100 ohm±10%            | ±100            |  |
| PV22□201A01 | 1.0(70°C)           | Flow/Soldering Iron | 22  | 200 ohm±10%            | ±100            |  |
| PV22□501A01 | 1.0(70°C)           | Flow/Soldering Iron | 22  | 500 ohm±10%            | ±100            |  |
| PV22□102A01 | 1.0(70°C)           | Flow/Soldering Iron | 22  | 1k ohm±10%             | ±100            |  |
| PV22□202A01 | 1.0(70°C)           | Flow/Soldering Iron | 22  | 2k ohm±10%             | ±100            |  |
| PV22□502A01 | 1.0(70°C)           | Flow/Soldering Iron | 22  | 5k ohm±10%             | ±100            |  |
| PV22□103A01 | 1.0(70°C)           | Flow/Soldering Iron | 22  | 10k ohm±10%            | ±100            |  |
| PV22□203A01 | 1.0(70°C)           | Flow/Soldering Iron | 22  | 20k ohm±10%            | ±100            |  |
| PV22□503A01 | 1.0(70°C)           | Flow/Soldering Iron | 22  | 50k ohm±10%            | ±100            |  |
| PV22□104A01 | 1.0(70°C)           | Flow/Soldering Iron | 22  | 100k ohm±10%           | ±100            |  |
| PV22□204A01 | 1.0(70°C)           | Flow/Soldering Iron | 22  | 200k ohm±10%           | ±100            |  |
| PV22□504A01 | 1.0(70°C)           | Flow/Soldering Iron | 22  | 500k ohm±10%           | ±100            |  |
| PV22□105A01 | 1.0(70°C)           | Flow/Soldering Iron | 22  | 1M ohm±10%             | ±100            |  |
| PV22□205A01 | 1.0(70°C)           | Flow/Soldering Iron | 22  | 2M ohm±10%             | ±100            |  |

### Construction



### Mounting Holes

PV22S



(Tolerance:±0.1 in mm)

PV22Y



(Tolerance:±0.1 in mm)

Continued on the following page. ↗

↳ Continued from the preceding page.

## ■ Characteristics

|                              |                 |              |
|------------------------------|-----------------|--------------|
| Temperature Cycle            | $\Delta$ TR     | $\pm 2\%$    |
|                              | $\Delta$ V.S.S. | $\pm 1\%$    |
| Humidity                     | $\Delta$ TR     | $\pm 2\%$    |
|                              | IR              | 100Mohm min. |
| Vibration (20G)              | $\Delta$ TR     | $\pm 1\%$    |
|                              | $\Delta$ V.S.S. | $\pm 1\%$    |
| Shock (50G)                  | $\Delta$ TR     | $\pm 1\%$    |
|                              | $\Delta$ V.S.S. | $\pm 1\%$    |
| Temperature Load Life        | $\Delta$ TR     | $\pm 3\%$    |
|                              | $\Delta$ V.S.S. | $\pm 1\%$    |
| Low Temperature Exposure     | $\Delta$ TR     | $\pm 1\%$    |
|                              | $\Delta$ V.S.S. | $\pm 1\%$    |
| High Temperature Exposure    | $\Delta$ TR     | $\pm 2\%$    |
|                              | $\Delta$ V.S.S. | $\pm 1\%$    |
| Rotational Life (200 cycles) | $\Delta$ TR     | $\pm 2\%$    |

$\Delta$ TR : Total Resistance Change  
 $\Delta$ V.S.S. : Voltage Setting Stability  
 IR : Insulation Resistance

## PV36 Series

### ■ Features

1. High resolution 25-turns enables precision adjustment easily.
2. Sealed construction protects the interior from dust and liquid, which achieves stable performance.
3. Available for ultrasonic cleaning after soldering
4. Clutch mechanism prevents excessive wiper rotation.
5. 5 standard terminal styles
6. Both Top and side adjustment directions.
7. To be complied with RoHS directive by new Cd free cermet resistive material. Pb free terminals with Sn plating.

### ■ Applications

1. Measuring instruments
2. OA equipment
3. Medical equipment
4. Power supply
5. Base station for cellular phone



PV36P

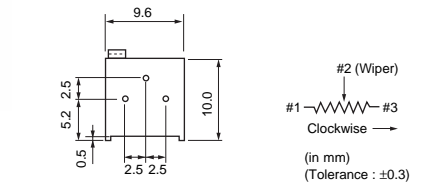
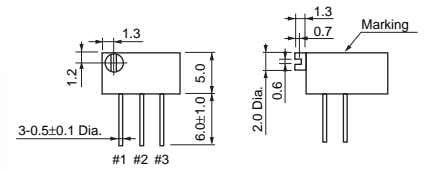

PV36W

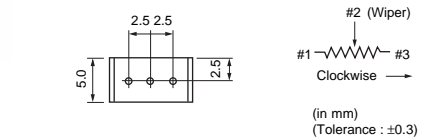
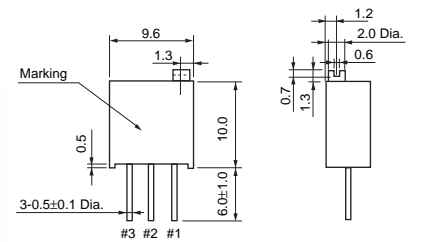

PV36X

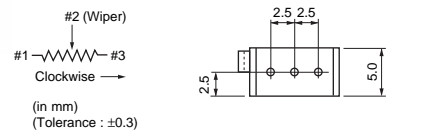
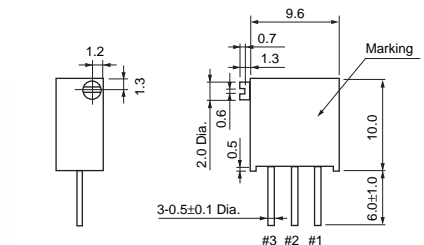

PV36Y

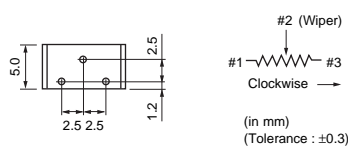
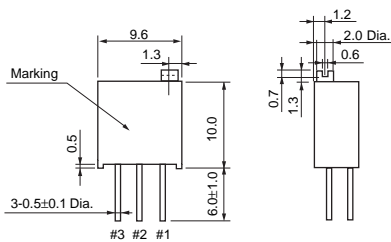

PV36Z

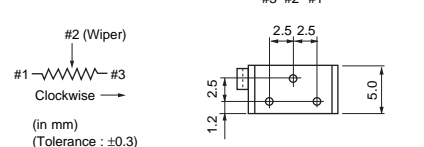
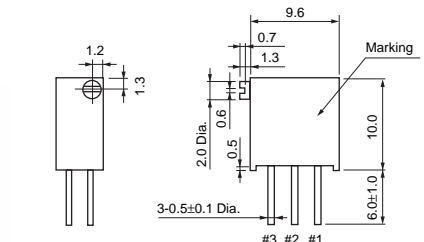

| Part Number | Power Rating | Soldering Method    | Number of Turns<br>(Effective Rotation Angle) | Total Resistance Value | TCR        |
|-------------|--------------|---------------------|---|------------------------|------------|
| PV36□100C01 | 0.5W(70°C)   | Flow/Soldering Iron | 25  | 10ohm ±10%             | ±150ppm/°C |
| PV36□200C01 | 0.5W(70°C)   | Flow/Soldering Iron | 25  | 20ohm ±10%             | ±150ppm/°C |
| PV36□500C01 | 0.5W(70°C)   | Flow/Soldering Iron | 25  | 50ohm ±10%             | ±150ppm/°C |

Continued on the following page. ↗

Continued from the preceding page.

| Part Number | Power Rating | Soldering Method    | Number of Turns<br>(Effective Rotation Angle) | Total Resistance Value | TCR        |
|-------------|--------------|---------------------|---|------------------------|------------|
| PV36□101C01 | 0.5W(70°C)   | Flow/Soldering Iron | 25  | 100ohm ±10%            | ±150ppm/°C |
| PV36□201C01 | 0.5W(70°C)   | Flow/Soldering Iron | 25  | 200ohm ±10%            | ±100ppm/°C |
| PV36□501C01 | 0.5W(70°C)   | Flow/Soldering Iron | 25  | 500ohm ±10%            | ±100ppm/°C |
| PV36□102C01 | 0.5W(70°C)   | Flow/Soldering Iron | 25  | 1k ohm ±10%            | ±100ppm/°C |
| PV36□202C01 | 0.5W(70°C)   | Flow/Soldering Iron | 25  | 2k ohm ±10%            | ±100ppm/°C |
| PV36□502C01 | 0.5W(70°C)   | Flow/Soldering Iron | 25  | 5k ohm ±10%            | ±100ppm/°C |
| PV36□103C01 | 0.5W(70°C)   | Flow/Soldering Iron | 25  | 10k ohm ±10%           | ±100ppm/°C |
| PV36□203C01 | 0.5W(70°C)   | Flow/Soldering Iron | 25  | 20k ohm ±10%           | ±100ppm/°C |
| PV36□253C01 | 0.5W(70°C)   | Flow/Soldering Iron | 25  | 25k ohm ±10%           | ±100ppm/°C |
| PV36□503C01 | 0.5W(70°C)   | Flow/Soldering Iron | 25  | 50k ohm ±10%           | ±100ppm/°C |
| PV36□104C01 | 0.5W(70°C)   | Flow/Soldering Iron | 25  | 100k ohm ±10%          | ±100ppm/°C |
| PV36□204C01 | 0.5W(70°C)   | Flow/Soldering Iron | 25  | 200k ohm ±10%          | ±100ppm/°C |
| PV36□254C01 | 0.5W(70°C)   | Flow/Soldering Iron | 25  | 250k ohm ±10%          | ±100ppm/°C |
| PV36□504C01 | 0.5W(70°C)   | Flow/Soldering Iron | 25  | 500k ohm ±10%          | ±100ppm/°C |
| PV36□105C01 | 0.5W(70°C)   | Flow/Soldering Iron | 25  | 1M ohm ±10%            | ±100ppm/°C |
| PV36□205C01 | 0.5W(70°C)   | Flow/Soldering Iron | 25  | 2M ohm ±10%            | ±100ppm/°C |
| PV36□100C31 | 0.5W(70°C)   | Flow/Soldering Iron | 25  | 10ohm ±10%             | ±150ppm/°C |
| PV36□200C31 | 0.5W(70°C)   | Flow/Soldering Iron | 25  | 20ohm ±10%             | ±150ppm/°C |
| PV36□500C31 | 0.5W(70°C)   | Flow/Soldering Iron | 25  | 50ohm ±10%             | ±150ppm/°C |
| PV36□101C31 | 0.5W(70°C)   | Flow/Soldering Iron | 25  | 100ohm ±10%            | ±150ppm/°C |
| PV36□201C31 | 0.5W(70°C)   | Flow/Soldering Iron | 25  | 200ohm ±10%            | ±100ppm/°C |
| PV36□501C31 | 0.5W(70°C)   | Flow/Soldering Iron | 25  | 500ohm ±10%            | ±100ppm/°C |
| PV36□102C31 | 0.5W(70°C)   | Flow/Soldering Iron | 25  | 1k ohm ±10%            | ±100ppm/°C |
| PV36□202C31 | 0.5W(70°C)   | Flow/Soldering Iron | 25  | 2k ohm ±10%            | ±100ppm/°C |
| PV36□502C31 | 0.5W(70°C)   | Flow/Soldering Iron | 25  | 5k ohm ±10%            | ±100ppm/°C |
| PV36□103C31 | 0.5W(70°C)   | Flow/Soldering Iron | 25  | 10k ohm ±10%           | ±100ppm/°C |
| PV36□203C31 | 0.5W(70°C)   | Flow/Soldering Iron | 25  | 20k ohm ±10%           | ±100ppm/°C |
| PV36□253C31 | 0.5W(70°C)   | Flow/Soldering Iron | 25  | 25k ohm ±10%           | ±100ppm/°C |
| PV36□503C31 | 0.5W(70°C)   | Flow/Soldering Iron | 25  | 50k ohm ±10%           | ±100ppm/°C |
| PV36□104C31 | 0.5W(70°C)   | Flow/Soldering Iron | 25  | 100k ohm ±10%          | ±100ppm/°C |
| PV36□204C31 | 0.5W(70°C)   | Flow/Soldering Iron | 25  | 200k ohm ±10%          | ±100ppm/°C |
| PV36□254C31 | 0.5W(70°C)   | Flow/Soldering Iron | 25  | 250k ohm ±10%          | ±100ppm/°C |
| PV36□504C31 | 0.5W(70°C)   | Flow/Soldering Iron | 25  | 500k ohm ±10%          | ±100ppm/°C |
| PV36□105C31 | 0.5W(70°C)   | Flow/Soldering Iron | 25  | 1M ohm ±10%            | ±100ppm/°C |
| PV36□205C31 | 0.5W(70°C)   | Flow/Soldering Iron | 25  | 2M ohm ±10%            | ±100ppm/°C |

Operating Temperature Range: -55 to 125 °C

The blank column is filled with the code of adjustment direction and lead type (P, X, Y, W and Z).

The order quantity should be an integral multiple of the "Minimum Quantity".

The last three digits express the individual specification codes. C01 for standard type and C31 for radial taping type (PV36W/PV36X series only).

| Part Number | Power Rating (W) | Soldering Method    | Number of Turns (Effective Rotation Angle) | Total Resistance Value | TCR (ppm/°C) | Remarks                            |
|-------------|------------------|---------------------|--|------------------------|--------------|------------------------------------|
| PV36□100A01 | 0.5(70°C)        | Flow/Soldering Iron | 25   | 10 ohm±10%             | ±100         | Non Standard Product (Cd included) |
| PV36□200A01 | 0.5(70°C)        | Flow/Soldering Iron | 25   | 20 ohm±10%             | ±100         |                                    |
| PV36□500A01 | 0.5(70°C)        | Flow/Soldering Iron | 25   | 50 ohm±10%             | ±100         |                                    |
| PV36□101A01 | 0.5(70°C)        | Flow/Soldering Iron | 25   | 100 ohm±10%            | ±100         |                                    |
| PV36□201A01 | 0.5(70°C)        | Flow/Soldering Iron | 25   | 200 ohm±10%            | ±100         |                                    |
| PV36□501A01 | 0.5(70°C)        | Flow/Soldering Iron | 25   | 500 ohm±10%            | ±100         |                                    |
| PV36□102A01 | 0.5(70°C)        | Flow/Soldering Iron | 25   | 1k ohm±10%             | ±100         |                                    |
| PV36□202A01 | 0.5(70°C)        | Flow/Soldering Iron | 25   | 2k ohm±10%             | ±100         |                                    |
| PV36□502A01 | 0.5(70°C)        | Flow/Soldering Iron | 25   | 5k ohm±10%             | ±100         |                                    |
| PV36□103A01 | 0.5(70°C)        | Flow/Soldering Iron | 25   | 10k ohm±10%            | ±100         |                                    |
| PV36□203A01 | 0.5(70°C)        | Flow/Soldering Iron | 25   | 20k ohm±10%            | ±100         |                                    |
| PV36□253A01 | 0.5(70°C)        | Flow/Soldering Iron | 25   | 25k ohm±10%            | ±100         |                                    |
| PV36□503A01 | 0.5(70°C)        | Flow/Soldering Iron | 25   | 50k ohm±10%            | ±100         |                                    |
| PV36□104A01 | 0.5(70°C)        | Flow/Soldering Iron | 25   | 100k ohm±10%           | ±100         |                                    |
| PV36□204A01 | 0.5(70°C)        | Flow/Soldering Iron | 25   | 200k ohm±10%           | ±100         |                                    |
| PV36□254A01 | 0.5(70°C)        | Flow/Soldering Iron | 25   | 250k ohm±10%           | ±100         |                                    |
| PV36□504A01 | 0.5(70°C)        | Flow/Soldering Iron | 25   | 500k ohm±10%           | ±100         |                                    |
| PV36□105A01 | 0.5(70°C)        | Flow/Soldering Iron | 25   | 1M ohm±10%             | ±100         |                                    |
| PV36□205A01 | 0.5(70°C)        | Flow/Soldering Iron | 25   | 2M ohm±10%             | ±100         |                                    |
| PV36□100A31 | 0.5(70°C)        | Flow/Soldering Iron | 25   | 10 ohm±10%             | ±100         |                                    |
| PV36□200A31 | 0.5(70°C)        | Flow/Soldering Iron | 25   | 20 ohm±10%             | ±100         |                                    |
| PV36□500A31 | 0.5(70°C)        | Flow/Soldering Iron | 25   | 50 ohm±10%             | ±100         |                                    |
| PV36□101A31 | 0.5(70°C)        | Flow/Soldering Iron | 25   | 100 ohm±10%            | ±100         |                                    |
| PV36□201A31 | 0.5(70°C)        | Flow/Soldering Iron | 25   | 200 ohm±10%            | ±100         |                                    |
| PV36□501A31 | 0.5(70°C)        | Flow/Soldering Iron | 25   | 500 ohm±10%            | ±100         |                                    |
| PV36□102A31 | 0.5(70°C)        | Flow/Soldering Iron | 25   | 1k ohm±10%             | ±100         |                                    |
| PV36□202A31 | 0.5(70°C)        | Flow/Soldering Iron | 25   | 2k ohm±10%             | ±100         |                                    |
| PV36□502A31 | 0.5(70°C)        | Flow/Soldering Iron | 25   | 5k ohm±10%             | ±100         |                                    |
| PV36□103A31 | 0.5(70°C)        | Flow/Soldering Iron | 25   | 10k ohm±10%            | ±100         |                                    |
| PV36□203A31 | 0.5(70°C)        | Flow/Soldering Iron | 25   | 20k ohm±10%            | ±100         |                                    |
| PV36□253A31 | 0.5(70°C)        | Flow/Soldering Iron | 25   | 25k ohm±10%            | ±100         |                                    |
| PV36□503A31 | 0.5(70°C)        | Flow/Soldering Iron | 25   | 50k ohm±10%            | ±100         |                                    |
| PV36□104A31 | 0.5(70°C)        | Flow/Soldering Iron | 25   | 100k ohm±10%           | ±100         |                                    |
| PV36□204A31 | 0.5(70°C)        | Flow/Soldering Iron | 25   | 200k ohm±10%           | ±100         |                                    |
| PV36□254A31 | 0.5(70°C)        | Flow/Soldering Iron | 25   | 250k ohm±10%           | ±100         |                                    |
| PV36□504A31 | 0.5(70°C)        | Flow/Soldering Iron | 25   | 500k ohm±10%           | ±100         |                                    |
| PV36□105A31 | 0.5(70°C)        | Flow/Soldering Iron | 25   | 1M ohm±10%             | ±100         |                                    |
| PV36□205A31 | 0.5(70°C)        | Flow/Soldering Iron | 25   | 2M ohm±10%             | ±100         |                                    |

■ Construction





## ■ Mounting Holes

PV36P



(Tolerance:±0.1  
in mm)

PV36W/X



(Tolerance:±0.1  
in mm)

PV36Y/Z



(Tolerance:±0.1  
in mm)

## ■ Characteristics

|                              |                 |  |
|------------------------------|-----------------|--|
| Temperature Cycle            | $\Delta TR$     | $\pm 2\%$  |
|                              | $\Delta V.S.S.$ | $\pm 1\%$  |
| Humidity                     | $\Delta TR$     | $\pm 2\%$  |
|                              | IR              | 100Mohm min.   |
| Vibration (20G)              | $\Delta TR$     | $\pm 1\%$  |
|                              | $\Delta V.S.S.$ | $\pm 1\%$  |
| Shock (100G)                 | $\Delta TR$     | $\pm 1\%$  |
|                              | $\Delta V.S.S.$ | $\pm 1\%$  |
| Temperature Load Life        | $\Delta TR$     | $\pm 3\%$  |
|                              | $\Delta V.S.S.$ | $\pm 1\%$  |
| Low Temperature Exposure     | $\Delta TR$     | $\pm 2\%$  |
|                              | $\Delta V.S.S.$ | $\pm 1\%$  |
| High Temperature Exposure    | $\Delta TR$     | $\pm 3\%$  |
|                              | $\Delta V.S.S.$ | $\pm 1\%$  |
| Rotational Life (200 cycles) | $\Delta TR$     | $R \leq 1\text{kohm}, R \geq 500\text{kohm} \dots \pm 5\%$ |
|                              |                 | $1\text{kohm} < R < 500\text{kohm} \dots \pm 3\%$          |

$\Delta TR$  : Total Resistance Change  
 $\Delta V.S.S.$  : Voltage Setting Stability  
 IR : Insulation Resistance  
 R : Standard Total Resistance

## PV12/PV37/PV23/PV22/PV36 Series Notice

### ■ Notice (Operating and Storage Conditions)

1. Store in temperatures of -10 to +40 deg. C and relative humidity of 30-85%RH.
2. Do not store in or near corrosive gases.
3. Use within six months after delivery.
4. Open the package just before using.
5. Do not store under direct sunlight.
6. If you use the trimmer potentiometer in an environment other than listed below, please consult with a Murata factory representative prior to using.  
The trimmer potentiometer should not be used under

- the following environmental conditions:
- (1) Corrosive gaseous atmosphere  
(Ex. Chlorine gas, Hydrogen sulfide gas, Ammonia gas, Sulfuric acid gas, Nitric oxide gas, etc.)
  - (2) In liquid  
(Ex. Oil, Medical liquid, Organic solvent, etc.)
  - (3) Dusty / dirty atmosphere
  - (4) Direct sunlight
  - (5) Static voltage nor electric/magnetic fields
  - (6) Direct sea breeze
  - (7) Other variations of the above

### ■ Notice (Rating)

1. When using with partial load (rheostat), minimize the power depending on the resistance value.
2. The maximum input voltage to a trimmer potentiometer should not exceed  $(P.R)^{1/2}$  or the maximum operating voltage, whichever is smaller.
3. The maximum input current to a trimmer potentiometer should not exceed  $(P/R)^{1/2}$  or the allowable wiper current, whichever is smaller.

### ■ Notice (Soldering and Mounting)

1. Soldering
  - (1) Standard soldering condition
    - (a) Flow soldering :
      - >Pre-heating temp. 80-100 deg. C
      - >Soldering temp. 260 deg. C max.
      - >Soldering time 3 sec. max.
    - (b) Soldering iron :
      - >Temperature of tip 300 deg. C max.
      - >Soldering time 3 sec. max.
      - >Wattage of iron 40W max.

Before using other soldering conditions than those listed above, please consult with Murata factory representative prior to using. If the soldering conditions are not suitable, e.g., excessive time and/or excessive temperature, the trimmer potentiometer may deviate from the specified characteristics.

  - (2) To minimize mechanical stress when adjusting, the trimmer potentiometer should be mounted onto PCB without gap.
  - (3) The soldering iron should not come in contact with the case of the trimmer potentiometer. If such contact does occur, the trimmer potentiometer may be damaged.
2. Mounting
  - (1) Use PCB hole to meet the pin of the trimmer potentiometer. If the trimmer potentiometer installs into insufficient PCB hole, the

- trimmer potentiometer may be damaged by mechanical stress.
- (2) Do not apply excessive force (preferably 9.8N (Ref.: 1kgf) max.), when the trimmer potentiometer is mounted to the PCB.
3. Cleaning
  - (1) Isopropyl-alcohol and Ethyl-alcohol are applicable solvents for cleaning. If you use any other types of solvents, please consult with a Murata factory representative prior to using.
  - (2) The total cleaning time by cold dipping, vapor and ultrasonic washing (conditions as below) method should be less than 3 minutes.
  - (3) For ultra-sonic cleaning, the available condition is as follows.
    - >Power: 600W (67 liter) max.
    - >Frequency: 28kHz
    - >Temperature: Ambient temperature

Due to the ultra-sonic cleaning equipment's peculiar self-resonance point and that the cleaning compatibility usually depends on the jig construction and/or the cleaning condition such as the depth of immersion, please check the cleaning equipment to determine the suitable conditions.

If the trimmer potentiometer is cleaned by other conditions, the trimmer potentiometer may be damaged.

## PV12/PV37/PV23/PV22/PV36 Series Notice

### ■ Notice (Handling)

1. Use suitable screwdrivers that fit comfortably in driver slot. We recommend the screwdrivers below.

\* Recommended screwdriver for manual adjustment  
ENGINEER INC. : DA-40

(Murata P/N : KMDR180)

We can supply the screwdrivers above.

If you place order, please specify the Murata P/N.

2. Don't apply more than 9.8N (Ref.; 1kgf) of twist and stress after mounting onto PCB to prevent contact intermittence. If excessive force is

applied, the trimmer potentiometer may not function.

3. When adjusting with an adjustment tool, the applied force to the adjustment screw should not exceed 4.9N (Ref.; 500gf). If excessive force is applied, the trimmer potentiometer may not function due to damage.

4. When using a lock paint to fix slot position, please use adhesive resin without chlorine or sulfur (Three-bond "1401 series").

### ■ Notice (Other)

1. Please make sure that your product has been evaluated and confirmed against your specifications when our product is mounted to your product.

2. Murata cannot guarantee trimmer potentiometer integrity when used under conditions other than those specified in this document.

## SMD Sealed Type/Lead Sealed Type Specifications and Test Methods

The following describes trimmer potentiometer testing conducted by Murata Manufacturing Co., Ltd. in accordance with MIL-R-22097 (Military specification for variable resistors, non-wirewound) and MIL-STD-202 (Test methods for electronic and electrical component parts).

| No.                               | Item                                  | Test Methods   |                                   |                          |              |                            |               |      |              |                  |                |      |                            |       |                |                            |               |       |             |      |        |      |
|-----------------------------------|---------------------------------------|--|-----------------------------------|--------------------------|--------------|----------------------------|---------------|------|--------------|------------------|----------------|------|----------------------------|-------|----------------|----------------------------|---------------|-------|-------------|------|--------|------|
| 1                                 | Total Resistance                      | <p>Measure total resistance between the resistance element and terminals (#1 and #3) with the contact arm positioned against a stop. The positioning of the contact arm and terminal should be the same for subsequent total resistance measurements on the same device. Use the test voltage specified in Table 1 for total resistance measurements. This voltage should be used for all subsequent total resistance measurements.</p> <table border="1" style="margin-left: auto; margin-right: auto; border-collapse: collapse;"> <thead> <tr style="background-color: #f2f2f2;"> <th>Total Resistance, Nominal (ohm)</th> <th>Maximum Test Voltage (V)</th> </tr> </thead> <tbody> <tr><td>10 ≤ R ≤ 100</td><td>1.0</td></tr> <tr><td>100 &lt; R ≤ 1k</td><td>3.0</td></tr> <tr><td>1k &lt; R ≤ 10k</td><td>10.0</td></tr> <tr><td>10k &lt; R ≤ 100k</td><td>30.0</td></tr> <tr><td>100k &lt; R</td><td>100.0</td></tr> </tbody> </table> <p style="text-align: center;">Table 1: Total resistance test voltage</p>  | Total Resistance, Nominal (ohm)   | Maximum Test Voltage (V) | 10 ≤ R ≤ 100 | 1.0                        | 100 < R ≤ 1k  | 3.0  | 1k < R ≤ 10k | 10.0             | 10k < R ≤ 100k | 30.0 | 100k < R                   | 100.0 |                |                            |               |       |             |      |        |      |
| Total Resistance, Nominal (ohm)   | Maximum Test Voltage (V)              |  |                                   |                          |              |                            |               |      |              |                  |                |      |                            |       |                |                            |               |       |             |      |        |      |
| 10 ≤ R ≤ 100                      | 1.0                                   |  |                                   |                          |              |                            |               |      |              |                  |                |      |                            |       |                |                            |               |       |             |      |        |      |
| 100 < R ≤ 1k                      | 3.0                                   |  |                                   |                          |              |                            |               |      |              |                  |                |      |                            |       |                |                            |               |       |             |      |        |      |
| 1k < R ≤ 10k                      | 10.0                                  |  |                                   |                          |              |                            |               |      |              |                  |                |      |                            |       |                |                            |               |       |             |      |        |      |
| 10k < R ≤ 100k                    | 30.0                                  |  |                                   |                          |              |                            |               |      |              |                  |                |      |                            |       |                |                            |               |       |             |      |        |      |
| 100k < R                          | 100.0                                 |  |                                   |                          |              |                            |               |      |              |                  |                |      |                            |       |                |                            |               |       |             |      |        |      |
| 2                                 | Residual Resistance                   | <p>Position the contact arm at the extreme counterclockwise limit of mechanical travel and measure the resistance between the contact arm and the corresponding end terminal. Then, position the contact arm at the extreme clockwise limit of mechanical travel and measure the resistance between the contact arm and the corresponding end terminal. During this test, take suitable precautions to ensure that the rated current of the resistance element is not exceeded.</p>  |                                   |                          |              |                            |               |      |              |                  |                |      |                            |       |                |                            |               |       |             |      |        |      |
| 3                                 | Contact Resistance Variation          | <p>Contact resistance variation should be measured with the measuring circuit shown in Figure 1, or its equivalent. The adjustment rotor (screw) should be rotated in both directions through 90% of the actual effective-electrical rotational angle (number of turns) for a total of 6 cycles. Only the last 3 cycles should count in determining whether or not a contact resistance variation is observed at least twice in the same location, exclusive of the roll-on or roll-off points where the contact arm moves from the termination, on or off, the resistance element. The rate of rotation of the adjustment rotor (screw) should be such that the adjustment rotor (screw) completes 1 cycle for 5 seconds minimum to 2 minutes maximum. The test current used should follow the value given in Table 2 unless otherwise limited by power rating.</p> <table border="1" style="margin-left: auto; margin-right: auto; border-collapse: collapse;"> <thead> <tr style="background-color: #f2f2f2;"> <th>Standard Total Resistance R (ohm)</th> <th>Test Current</th> </tr> </thead> <tbody> <tr><td>R ≤ 100</td><td>20mA</td></tr> <tr><td>100 &lt; R &lt; 500</td><td>10mA</td></tr> <tr><td>500 ≤ R &lt; 1k</td><td>4mA</td></tr> <tr><td>1k ≤ R &lt; 2k</td><td>2mA</td></tr> <tr><td>2k ≤ R &lt; 50k</td><td>1mA</td></tr> <tr><td>50k ≤ R &lt; 200k</td><td>200µA</td></tr> <tr><td>200k ≤ R &lt; 1M</td><td>100µA</td></tr> <tr><td>1M ≤ R &lt; 2M</td><td>50µA</td></tr> <tr><td>2M ≤ R</td><td>30µA</td></tr> </tbody> </table> <div style="text-align: right; margin-top: 10px;">  <p style="font-size: small;">Rx : Trimmer Potentiometer<br/>Oscilloscope bandwidth : 100Hz to 50kHz</p> </div> <p style="text-align: center;">Figure 1: CRV measuring circuit</p> <p style="text-align: center;">Table 2: Test current for CRV</p> | Standard Total Resistance R (ohm) | Test Current             | R ≤ 100      | 20mA                       | 100 < R < 500 | 10mA | 500 ≤ R < 1k | 4mA              | 1k ≤ R < 2k    | 2mA  | 2k ≤ R < 50k               | 1mA   | 50k ≤ R < 200k | 200µA                      | 200k ≤ R < 1M | 100µA | 1M ≤ R < 2M | 50µA | 2M ≤ R | 30µA |
| Standard Total Resistance R (ohm) | Test Current                          |  |                                   |                          |              |                            |               |      |              |                  |                |      |                            |       |                |                            |               |       |             |      |        |      |
| R ≤ 100                           | 20mA                                  |  |                                   |                          |              |                            |               |      |              |                  |                |      |                            |       |                |                            |               |       |             |      |        |      |
| 100 < R < 500                     | 10mA                                  |  |                                   |                          |              |                            |               |      |              |                  |                |      |                            |       |                |                            |               |       |             |      |        |      |
| 500 ≤ R < 1k                      | 4mA                                   |  |                                   |                          |              |                            |               |      |              |                  |                |      |                            |       |                |                            |               |       |             |      |        |      |
| 1k ≤ R < 2k                       | 2mA                                   |  |                                   |                          |              |                            |               |      |              |                  |                |      |                            |       |                |                            |               |       |             |      |        |      |
| 2k ≤ R < 50k                      | 1mA                                   |  |                                   |                          |              |                            |               |      |              |                  |                |      |                            |       |                |                            |               |       |             |      |        |      |
| 50k ≤ R < 200k                    | 200µA                                 |  |                                   |                          |              |                            |               |      |              |                  |                |      |                            |       |                |                            |               |       |             |      |        |      |
| 200k ≤ R < 1M                     | 100µA                                 |  |                                   |                          |              |                            |               |      |              |                  |                |      |                            |       |                |                            |               |       |             |      |        |      |
| 1M ≤ R < 2M                       | 50µA                                  |  |                                   |                          |              |                            |               |      |              |                  |                |      |                            |       |                |                            |               |       |             |      |        |      |
| 2M ≤ R                            | 30µA                                  |  |                                   |                          |              |                            |               |      |              |                  |                |      |                            |       |                |                            |               |       |             |      |        |      |
| 4                                 | Temperature Coefficient of Resistance | <p>The trimmer potentiometer should be subjected to each of the following temperatures (see Table 3) for 30-45 minutes. Temperature coefficient of resistance should be applied to the following formula.</p> $TCR = \frac{R_2 - R_1}{R_1 (T_2 - T_1)} \times 10^6 \text{ (ppm/°C)}$ <p style="margin-left: 20px;"> <math>T_1</math> : Reference temperature in degrees celsius<br/> <math>T_2</math> : Test temperature in degrees celsius<br/> <math>R_1</math> : Resistance at reference temperature ohm<br/> <math>R_2</math> : Resistance at test temperature in ohm         </p> <table border="1" style="margin-left: auto; margin-right: auto; border-collapse: collapse; text-align: center;"> <thead> <tr style="background-color: #f2f2f2;"> <th>Sequence</th> <th>1*</th> <th>2</th> <th>3</th> <th>4*</th> <th>5</th> <th>6</th> </tr> </thead> <tbody> <tr style="background-color: #f2f2f2;"> <th>Temperature (°C)</th> <td>+25</td> <td>-15</td> <td>Min. operating Temperature</td> <td>+25</td> <td>+65</td> <td>Max. operating Temperature</td> </tr> </tbody> </table> <p style="font-size: small;">Note*: Reference temperature</p> <p style="text-align: center;">Table 3: Test temperatures</p>   | Sequence                          | 1*                       | 2            | 3                          | 4*            | 5    | 6            | Temperature (°C) | +25            | -15  | Min. operating Temperature | +25   | +65            | Max. operating Temperature |               |       |             |      |        |      |
| Sequence                          | 1*                                    | 2  | 3                                 | 4*                       | 5            | 6                          |               |      |              |                  |                |      |                            |       |                |                            |               |       |             |      |        |      |
| Temperature (°C)                  | +25                                   | -15  | Min. operating Temperature        | +25                      | +65          | Max. operating Temperature |               |      |              |                  |                |      |                            |       |                |                            |               |       |             |      |        |      |
| 5                                 | Voltage Setting Stability             | <p>The wiper should be set at approximately 40% of the actual effective-electrical rotational angle (number of turns). An adequate DC test potential should be applied between terminal #1 and terminal #3. The voltage between terminal #1 and terminal #3, and the voltage between terminal #1 and terminal #2, should be measured and applied to the following formula.</p> $\text{Voltage setting stability} = \left( \frac{e'}{E} - \frac{e}{E} \right) \times 100 \text{ (\%)}$ <p style="margin-left: 20px;"> <math>e</math> : Before test<br/>             (The voltage between terminal #1 and terminal #2)<br/> <math>e'</math> : After test<br/>             (The voltage between terminal #1 and terminal #2)<br/> <math>E</math> : The voltage between terminal #1 and terminal #3         </p> <div style="text-align: right; margin-top: 10px;">  </div> <p style="text-align: center;">Figure 2</p>   |                                   |                          |              |                            |               |      |              |                  |                |      |                            |       |                |                            |               |       |             |      |        |      |

Continued on the following page.

## SMD Sealed Type/Lead Sealed Type Specifications and Test Methods

Continued from the preceding page.

| No.         | Item   | Test Methods  |                  |        |   |   |   |            |                      |       |                  |       |  |                      |  |       |  |             |    |        |    |        |
|-------------|--|---|------------------|--------|---|---|---|------------|----------------------|-------|------------------|-------|--|----------------------|--|-------|--|-------------|----|--------|----|--------|
| 6           | Temperature Cycle  | <p>The trimmer potentiometer should be subjected to Table 4 temperature for 5 cycles. The trimmer potentiometer should be removed from the chamber, and maintained at a temperature of 25±5°C for 1–2 hours.</p> <table border="1"> <thead> <tr> <th>Sequence</th> <th>1</th> <th>2</th> <th>3</th> <th>4</th> </tr> </thead> <tbody> <tr> <td>Temp. (°C)</td> <td>PV□□ series<br/>-55±3</td> <td>+25±2</td> <td>+125±3<br/>+150±3</td> <td>+25±2</td> </tr> <tr> <td></td> <td>PV22 series<br/>-25±3</td> <td></td> <td>+60±3</td> <td></td> </tr> <tr> <td>Time (min.)</td> <td>30</td> <td>5 max.</td> <td>30</td> <td>5 max.</td> </tr> </tbody> </table> <p>Table 4: One cycle of temperature cycle.</p>   | Sequence         | 1      | 2 | 3 | 4 | Temp. (°C) | PV□□ series<br>-55±3 | +25±2 | +125±3<br>+150±3 | +25±2 |  | PV22 series<br>-25±3 |  | +60±3 |  | Time (min.) | 30 | 5 max. | 30 | 5 max. |
| Sequence    | 1  | 2   | 3                | 4      |   |   |   |            |                      |       |                  |       |  |                      |  |       |  |             |    |        |    |        |
| Temp. (°C)  | PV□□ series<br>-55±3                                       | +25±2   | +125±3<br>+150±3 | +25±2  |   |   |   |            |                      |       |                  |       |  |                      |  |       |  |             |    |        |    |        |
|             | PV22 series<br>-25±3                                       |   | +60±3            |        |   |   |   |            |                      |       |                  |       |  |                      |  |       |  |             |    |        |    |        |
| Time (min.) | 30   | 5 max.  | 30               | 5 max. |   |   |   |            |                      |       |                  |       |  |                      |  |       |  |             |    |        |    |        |
| 7           | Humidity   | <p>1) PVC6, PV12, PV32, PV34 PVM4A□□□D01 series<br/>The trimmer potentiometer should be placed in a chamber at a temperature of 40±2°C and a humidity of 90–95% without loading for 250±8 hours (500±12 hours for PVM4A□□□D01 series). The trimmer potentiometer should be removed from the chamber, and maintained at a temperature of 25±5°C for 5±1/6 hours.</p> <p>2) PVF2 series<br/>The trimmer potentiometer should be placed in a chamber at 60±2°C and 90–95% without loading for 1000±12 hours. The trimmer potentiometer should be removed from the chamber, and maintained at a temperature of 25±5°C for 5±1/6 hours</p> <p>2) PVG3, PVG5, PV01, PV22, PV23, PV36, PV37 series<br/>The trimmer potentiometer should be subjected Figure-3 the programmed humidity environment for 10 cycle. The trimmer potentiometer should be removed from the chamber, and maintained at a temperature of 25±5°C for 1.5±1/2 hours.</p> <p>Figure 3</p> |                  |        |   |   |   |            |                      |       |                  |       |  |                      |  |       |  |             |    |        |    |        |
| 8           | Vibration  | <p>1) PV□□ series<br/>The trimmer potentiometer should be vibrated throughout the frequency range at the 20G level. A complete frequency range, 10Hz to 2000Hz and back, should be made within 15 minutes for a total of 4 sweeps in each of the three axis direction for a total of 12 sweeps.</p> <p>2) PVF2 series<br/>The trimmer potentiometer should be subjected to vibration at 0.3 inch amplitude. The frequency should be varied uniformly between the approximate limits of 10Hz and 55Hz. This motion should be applied for period of 2 hours in each of 3 mutually perpendicular directions (total of 6 hours).</p>  |                  |        |   |   |   |            |                      |       |                  |       |  |                      |  |       |  |             |    |        |    |        |
| 9           | Shock  | <p>1) PV□□ series<br/>The trimmer potentiometer should be shocked at the 100G (50G for PV22 and PV23 series) level and should be subjected to 4 shocks in each of the three axis directions for a total of 12 shocks.</p> <p>2) PVM4A□□□D01 series<br/>The trimmer potentiometer should be shocked at the 100G level and should be subjected to 3 shocks in each of the six axis directions for a total of 18 shocks.</p>   |                  |        |   |   |   |            |                      |       |                  |       |  |                      |  |       |  |             |    |        |    |        |
| 10          | Temperature Road Life                                      | <p>Full rated continuous working voltage not exceeding the maximum rated voltage should be applied intermittently between terminal #1 and terminal #3 of the trimmer potentiometer, 1.5 hours on and 0.5 hours off, for a total of 1000±12 hours, at a temperature of 70±2°C (85±2°C for PV01 and PV37 series, 50±2°C for PVF2 series). The trimmer potentiometer should be removed from the chamber, and maintained at a temperature of 25±5°C for 1 to 2 hours.</p>   |                  |        |   |   |   |            |                      |       |                  |       |  |                      |  |       |  |             |    |        |    |        |
| 11          | High Temperature Exposure (Except for PVF2)                | <p>The trimmer potentiometer should be placed in a chamber at a temperature of 125±3°C (150±3°C for PV22 series) 250±8 hours without loading. The trimmer potentiometer should be removed from the chamber, and maintained at a temperature of 25±5°C for 1 to 2 hours.</p>   |                  |        |   |   |   |            |                      |       |                  |       |  |                      |  |       |  |             |    |        |    |        |
| 12          | Low Temperature Exposure (Except for PVF2 and PVM4A□□□D01) | <p>The trimmer potentiometer should be placed in a chamber at a temperature of -55±3°C for 1 hours without loading. Full rated continuous working voltage not exceeding the maximum rated voltage should be applied for 45 minutes. The trimmer potentiometer should be removed from the chamber, and maintained at a temperature of 25±5°C for approximately 24 hours.</p>   |                  |        |   |   |   |            |                      |       |                  |       |  |                      |  |       |  |             |    |        |    |        |

Continued on the following page. ↗

## SMD Sealed Type/Lead Sealed Type Specifications and Test Methods

☐ Continued from the preceding page.

| No. | Item   | Test Methods  |
|-----|--|---|
| 13  | Low Temperature Operation<br>(Only for PVF2 and PVM4A□□□D01) | The trimmer potentiometer should be placed in a chamber at a temperature of $-25\pm 3^{\circ}\text{C}$ ( $-55\pm 3^{\circ}\text{C}$ for PVM4A□□□D01 series) $48\pm 4$ hours without loading. The trimmer potentiometer should be removed from the chamber, and maintained at a temperature of $25\pm 5^{\circ}\text{C}$ for 1-2 hours   |
| 14  | Rotational Life  | <p>1) PV□□ series<br/>Full rated continuous working voltage not exceeding the maximum rated voltage should be applied with the circuit shown in the figure. The adjustment rotor (screw) should be continuously cycled through not less than 90% of effective-electrical rotational angle (number of turns), at the rate of 1 cycle for 5 seconds minimum to 2.5 minutes maximum for total of 200 cycles.</p> <div style="text-align: center;">  <p>Figure 4</p> </div> <p>2) PVG3, PVG5 series<br/>The adjustment rotor (screw) should be continuously cycled though not less than 90% of effective-electrical rotational angle (number of turns), at the rate of 1 cycle for 5 seconds minimum to 2.5 minutes maximum for a total of 50 (100 for PVG5) cycles, without loading.</p> <p>3) PVF2, PVM4A□□□D01 series<br/>The wiper should be rotated over 90% of the effective rotational angle without loading at a speed of 10 cycles per minute, for 100 cycles continuously.</p> |

Компания «Life Electronics» занимается поставками электронных компонентов импортного и отечественного производства от производителей и со складов крупных дистрибьюторов Европы, Америки и Азии.

С конца 2013 года компания активно расширяет линейку поставок компонентов по направлению коаксиальный кабель, кварцевые генераторы и конденсаторы (керамические, пленочные, электролитические), за счёт заключения дистрибьюторских договоров

Мы предлагаем:

- Конкурентоспособные цены и скидки постоянным клиентам.
- Специальные условия для постоянных клиентов.
- Подбор аналогов.
- Поставку компонентов в любых объемах, удовлетворяющих вашим потребностям.
- Приемлемые сроки поставки, возможна ускоренная поставка.
- Доставку товара в любую точку России и стран СНГ.
- Комплексную поставку.
- Работу по проектам и поставку образцов.
- Формирование склада под заказчика.
- Сертификаты соответствия на поставляемую продукцию (по желанию клиента).
- Тестирование поставляемой продукции.
- Поставку компонентов, требующих военную и космическую приемку.
- Входной контроль качества.
- Наличие сертификата ISO.

В составе нашей компании организован Конструкторский отдел, призванный помогать разработчикам, и инженерам.

Конструкторский отдел помогает осуществить:

- Регистрацию проекта у производителя компонентов.
- Техническую поддержку проекта.
- Защиту от снятия компонента с производства.
- Оценку стоимости проекта по компонентам.
- Изготовление тестовой платы монтаж и пусконаладочные работы.



Тел: +7 (812) 336 43 04 (многоканальный)  
Email: [org@lifeelectronics.ru](mailto:org@lifeelectronics.ru)