

# Tactile Switch B3F

## Miniature, Space-Saving Tactile Switch Provides Long Service Life and Easy Mounting

- Extended mechanical/electrical service life: 10 x 10<sup>6</sup> operations for 12 x 12 mm type and 1 x 10<sup>6</sup> operations for the 6 x 6 mm type
- Ideal for applications such as audio, office and communications equipment, measuring instruments, TVs, VCRs, etc.
- Taped radial type, vertical type and high force types are available.
- Gold plated models available for increased contact reliability, resistance to corrosive gas and insulation fault prevention for ion migration in harsh environments
- RoHS Compliant



## Ordering Information

■ B3F-1□□□, B3F-3□□□

### 6 x 6 mm type

Type	Plunger	Switch height	Operating force	Model	
				Without ground terminal	With ground terminal
				Bags	Bags
Standard		4.3 mm	General-purpose: 100 g	<b>B3F-1000</b>	<b>B3F-1100</b>
			150 g	<b>B3F-1002</b>	<b>B3F-1102</b>
		High-force: 260 g	<b>B3F-1005</b>	<b>B3F-1105</b>	
	5.0 mm	General-purpose: 100 g	<b>B3F-1020</b>	<b>B3F-1120</b>	
		150 g	<b>B3F-1022</b>	<b>B3F-1122</b>	
		High-force: 260 g	<b>B3F-1025</b>	<b>B3F-1125</b>	
5.0 mm (7.5 mm pitch)	General-purpose: 100 g	—	<b>B3F-1110</b>		
Projected		7.3 mm	General-purpose: 100 g	<b>B3F-1050</b>	<b>B3F-1150</b>
			150 g	<b>B3F-1052</b>	<b>B3F-1152</b>
			High-force: 260 g	<b>B3F-1055</b>	<b>B3F-1155</b>
Vertical		3.15 mm	General-purpose: 100 g	—	<b>B3F-3100</b>
			150 g	—	<b>B3F-3102</b>
		High-force: 260 g	—	<b>B3F-3105</b>	
	3.85 mm	General-purpose: 100 g	—	<b>B3F-3120</b>	
		150 g	—	<b>B3F-3122</b>	
		High-force: 260 g	—	<b>B3F-3125</b>	
Projected		6.15 mm	General-purpose: 100 g	—	<b>B3F-3150</b>
			150 g	—	<b>B3F-3152</b>
			High-force: 260 g	—	<b>B3F-3155</b>

**Important Note:** Switches cannot be water-washed.

■ B3F-1□□□-G

6 x 6 mm type with Gold Plating

Type	Plunger	Switch height	Form of shipment operating force	Model	
				Without ground terminal	With ground terminal
				Bags (100 Switches)	
6 x 6 mm switches with gold plating		4.3 mm	180 g	B3F-1002-G	B3F-1102-G
		5.0 mm		B3F-1022-G	B3F-1122-G

Note: The minimum order is 100 Switches. Order in multiples of the minimum order.

■ B3F-4□□□, B3F-5□□□



12 x 12 mm type

Type	Plunger	Switch height	Operating force	Model	
				Without ground terminal	With ground terminal
				Bags	Bags
Standard		4.3 mm	General-purpose: 130 g	B3F-4000	B3F-4100
			High-force: 260 g	B3F-4005	B3F-4105
		7.3 mm	General-purpose: 130 g	B3F-4050	B3F-4150
			High-force: 260 g	B3F-4055	B3F-4155
Long service life		4.3 mm	General-purpose: 130 g	B3F-5000	B3F-5100
		7.3 mm		B3F-5050	B3F-5150
High reliability gold-plated contact		4.3 mm		B3F-5001	B3F-5101
		7.3 mm		B3F-5051	B3F-5151

Important Note: Switches cannot be water-washed.

■ B3F-6□□□□

**Taped Radial (Auto Insertion)  
6 x 6 mm type**

Type	Plunger	Switch height	Operating force	Model	
				Without ground terminal	With ground terminal
B3F-6000	Flat 	4.3 mm	General-purpose: 100 g	<b>B3F-6000</b>	<b>B3F-6100</b>
			High-force: 150 g	<b>B3F-6002</b>	<b>B3F-6102</b>
	5.0 mm	General-purpose: 100 g	<b>B3F-6020</b>	<b>B3F-6120</b>	
		High-force: 150 g	<b>B3F-6022</b>	<b>B3F-6122</b>	
Projected 	7.3 mm	General-purpose: 100 g	<b>B3F-6050</b>	<b>B3F-6150</b>	
		High-force: 150 g	<b>B3F-6052</b>	<b>B3F-6152</b>	

**Note:** The above switches must be ordered in units of 1,000.

**Important Note:** Switches cannot be water-washed.

■ **Accessories**

See “B32” Tactile Switch Key Top data sheet for keycaps that fit projected plunger B3F models.

■ **Plunger Identification Tables**

Use these tables to determine tactile switch type by plunger color.

**B3F-1□□□□/-3□□□□/-6□□□□**

Plunger color	Operating force	Type
Ivory	100 g	B3F-1000, 1100, 1050, 1150, 3100, 3150, 6000, 6100, 6050, 6150
Black	100 g	B3F-1020, 1120, 1110, 3120, 6020, 6120
Yellow	150 g	B3F-1002, 1102, 1052, 1152, 3102, 3152, 6002, 6102, 6052, 6152
	180 g	B3F-1002-G, 1102-G
Gray	150 g	B3F-1022, 1122, 3122, 6022, 6122
	180 g	B3F-1022-G, 1122-G
Orange	260 g	B3F-1005, 1105, 1055, 1155, 3105, 3155, 6005, 6055
Pink	260 g	B3F-1025, 1125, 3125, 6025

**B3F-4□□□□/-5□□□□**

Plunger color	Operating force	Type
Ivory	130 g	B3F-4000, 4100, 4050, 4150
Yellow	260 g	B3F-4005, 4105, 4055, 4155
Blue	130 g	B3F-5000 Series

# Specifications

## ■ Characteristics

	Part Number				
	B3F-1□□□ B3F-3□□□	B3F-4□□□	B3F-5□□□	B3F-6□□□	B3F-1□□□-G
Contact form	SPST-NO				
Switching capacity	1 to 50 mA, 5 to 24 VDC (resistive load)				100 μA to 50 mA, 5 to 24 VDC (resistive load)
Contact resistance	100 mΩ max. (rated: 1mA, 5VDC)				100 mΩ max. (rated: 100 μA, 5 VDC)
Insulation resistance	100 MΩ min. (at 250 VDC)				
Dielectric strength	500 VAC, 50/60 Hz for 1 minute				
Bounce time	5 ms max.				
Vibration resistance	Malfunction durability: 10 to 55 Hz, 1.5 mm double amplitude for 30 to 60 s				
Shock resistance	Mechanical durability: 1,000 m/s <sup>2</sup> (approx. 100 G) Malfunction durability: 100 m/s <sup>2</sup> (approx. 10 G)				
Ambient operating temperature	-25° to 70°C (at 60% RH max.) with no icing or condensation				
Ambient operating humidity	35% to 85% RH (at 5 to 35 °C)				
Weight	Approx. 0.25 g	Approx. 0.85 g		Approx. 0.25 g	

Note: Data shown are of initial value.

## ■ Life Expectancy

B3F-1000, B3F-3000, B3F-6000:
1,000,000 operations min (OF: 100gf) (B3F-1070: 500,000 operations min)
300,000 operations min (OF: 150 gf)
100,000 operations min (OF: 260gf)
B3F-G:
300,000 operations min (OF: 180gf)
B3F-4000:
3,000,000 operations min (OF: 130gf)
1,000,000 operations min (OF: 260gf)
B3F-5000:
10,000,000 operations min.

## ■ Operating Characteristics

Characteristics	Part Number							
	B3F-1□□□ / -3□□□			B3F-4□□□ / -5□□□		B3F-6□□□		B3F-1□□□-G
	General purpose type		High force type	General purpose type	High force type	General purpose type	High force type	General purpose type
Operating force (OF)	100 ± 30 g	150 ± 50 g	260 ± 70 gf	130 ± 50 g	260 ± 70 g	100 ± 30 g	150 ± 50 g	180 ± 50 g
Release force (RF) min.	20 g	50 g	50 gf	30 g	50 g	20 g	50 g	50 g
Pretravel (PT)	0.25 <sup>+0.2</sup> / <sub>-0.1</sub> mm			0.3 <sup>+0.2</sup> / <sub>-0.1</sub> mm		0.25 <sup>+0.2</sup> / <sub>-0.1</sub> mm		

# Dimensions

- Note:** 1. Unless otherwise specified, all units are in millimeters and a tolerance of  $\pm 0.4$  mm applies to all dimensions.  
 2. Terminal numbers are not indicated on this switch. With the switch turned over so that the logo mark "OMRON" is visible on the upper part of the rear side of the switch base, the terminal on the right of the logo mark is numbered "1" and that on the bottom right is "3." Accordingly, two terminals on the left side are numbered "2" and "4" respectively.

## 6 x 6 mm Models

### Standard, Flat Plunger Type (without Ground Terminal)

B3F-1000, B3F-1002, B3F-1005, B3F-1020\*, B3F-1022\*, B3F-1025\*, B3F-1002-G, B3F-1022-G\*



\* The height of B3F-1020, B3F-1022, B3F-1025, and B3F-1026 is 5±0.2 mm.

### Standard, Projected Plunger Type (without Ground Terminal)

B3F-1050, B3F-1052, B3F-1055



### Standard, Flat Plunger Type (with Ground Terminal, Pitch: 6.5 mm)

B3F-1100, B3F-1102, B3F-1105, B3F-1120\*, B3F-1122\*, B3F-1125\*, B3F-1102-G, B3F-1122-G\*



\*The height of B3F-1120, B3F-1122, and B3F-1125 is 5±0.2 mm.

### Standard, Projected Plunger Type (with Ground Terminal)

B3F-1150, B3F-1152, B3F-1155



### Standard, Flat Plunger Type (with Ground Terminal, Pitch: 7.5 mm)

B3F-1110



**Side-operated, Flat Plunger Type**

B3F-3100, B3F-3102, B3F-3105



**Side-operated, Projected Plunger Type**

B3F-3150, B3F-3152, B3F-3155



**Side-operated, Flat Plunger Type (Height: 3.85 mm)**

B3F-3120, B3F-3122, B3F-3125



■ 12 x 12 mm Models

Standard, Long-life,  
and High-reliability Models  
Flat Plunger Type  
(without Ground Terminal)

B3F-4000, B3F-4005,  
B3F-5000, B3F-5001



PCB Mounting (Top View)  
(Single-sided PCB, t=1.6)

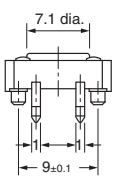
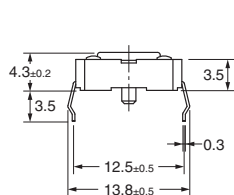
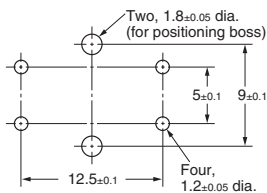

Terminal Arrangement/  
Internal Connections  
(Top View)



Standard, Long-life,  
and High-reliability Models  
Projected Plunger Type  
(without Ground Terminal)

B3F-4050, B3F-4055,  
B3F-5050, B3F-5051



PCB Mounting (Top View)  
(Single-sided PCB, t=1.6)

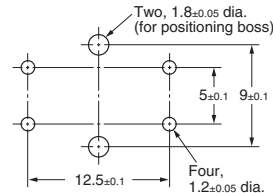

Terminal Arrangement/  
Internal Connections  
(Top View)



Standard, Long-life,  
and High-reliability Models  
Flat Plunger Type  
(with Ground Terminal)

B3F-4100, B3F-4105,  
B3F-5100, B3F-5101



PCB Mounting (Top View)  
(Single-sided PCB, t=1.6)

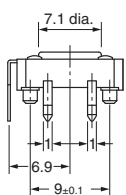
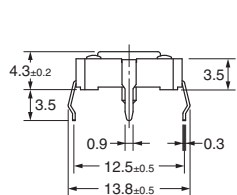
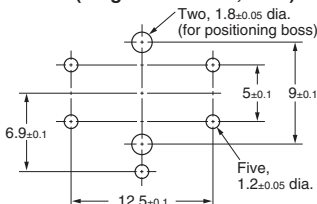
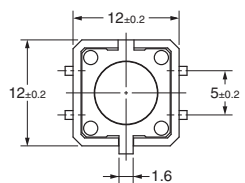

Terminal Arrangement/  
Internal Connections  
(Top View)



Standard, Long-life,  
and High-reliability Models  
Projected Plunger Type  
(with Ground Terminal)

B3F-4150, B3F-4155,  
B3F-5150, B3F-5151

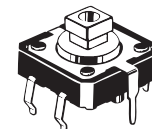

PCB Mounting (Top View)  
(Single-sided PCB, t=1.6)

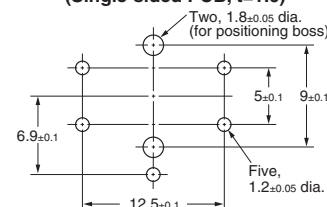
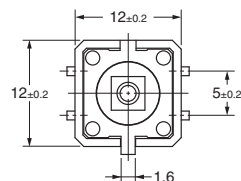

Terminal Arrangement/  
Internal Connections  
(Top View)

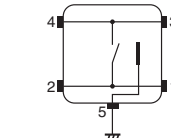

■ 6 x 6 mm Radial Taped Models: Sold in units of 1,000 switches

**Note:** Terminal numbers are not indicated on this switch. With the switch turned over so that the logo mark “OMRON” is visible on the upper part of the rear side of the switch base, the terminal on the top of the logo mark is numbered “1” and that on the bottom is “2.”

**Flat Plunger Type  
(without Ground Terminal)  
B3F-6000, B3F-6002**

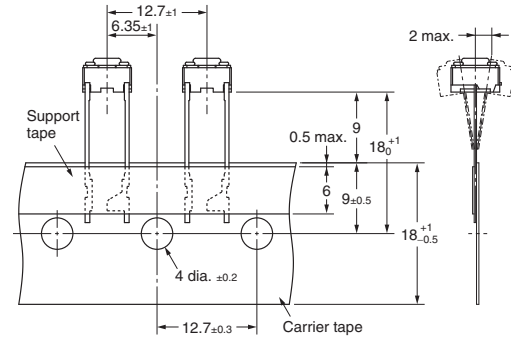
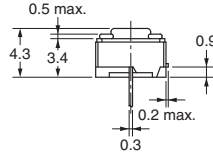
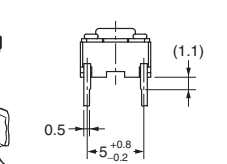

**Note:** The tape is random between surface A and surface B.

**PCB Mounting  
(Top View)  
(Single-sided PCB, t=1.6)**

**Terminal Arrangement  
/Internal Connections  
(Top View)**

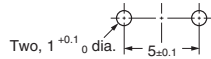

**Flat Plunger Type  
(with Ground Terminal)  
B3F-6100, B3F-6102**

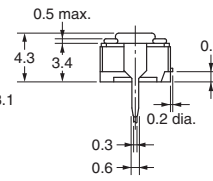
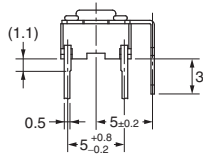
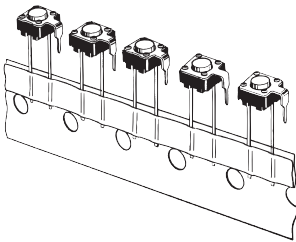

**PCB Mounting  
(Top View)  
(Single-sided PCB, t=1.6)**

**Terminal Arrangement  
/Internal Connections  
(Top View)**



**Flat Plunger Type  
(without Ground Terminal)  
B3F-6020, B3F-6022**

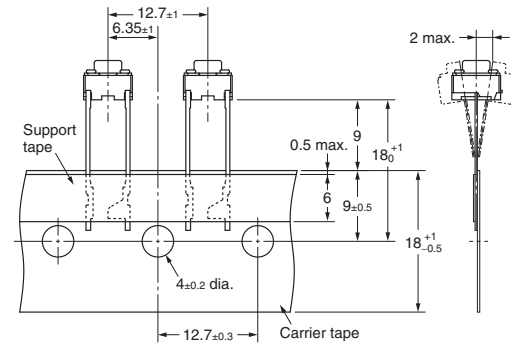
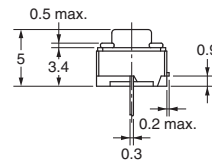
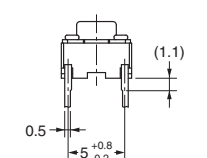

**Note:** The tape is random between surface A and surface B.

**PCB Mounting  
(Top View)  
(Single-sided PCB, t=1.6)**

**Terminal Arrangement  
/Internal Connections  
(Top View)**

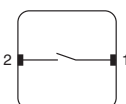
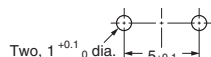



**Flat Plunger Type  
(with Ground Terminal)  
B3F-6120, B3F-6122**

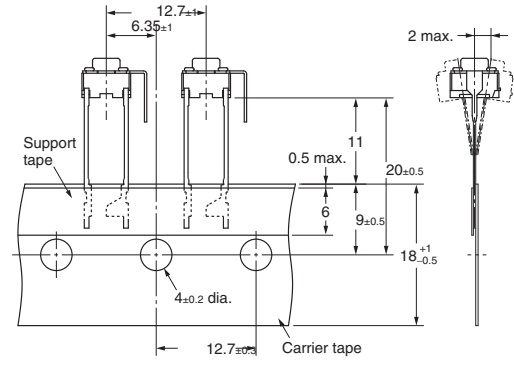
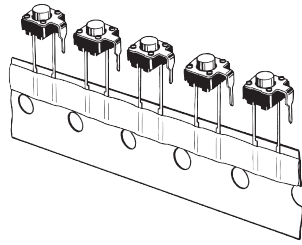

**PCB Mounting  
(Top View)  
(Single-sided PCB, t=1.6)**



**Terminal Arrangement  
/Internal Connections  
(Top View)**

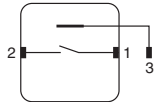

**Projected Plunger Type  
(without Ground Terminal)  
B3F-6050, B3F-6052**

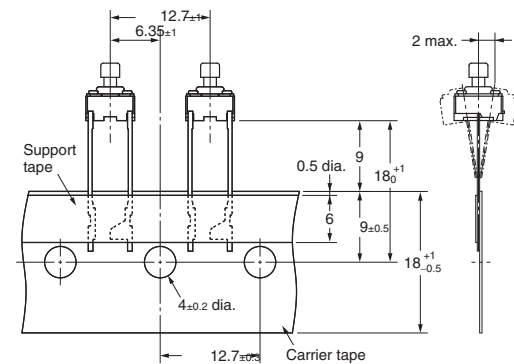
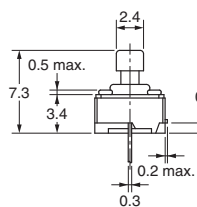
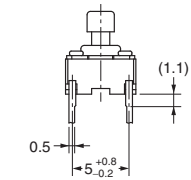

**PCB Mounting  
(Top View)  
(Single-sided PCB, t=1.6)**



**Terminal Arrangement  
/Internal Connections  
(Top View)**

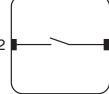

**Note:** The tape is random between surface A and surface B.

**Projected Plunger Type  
(with Ground Terminal)  
B3F-6150, B3F-6152**

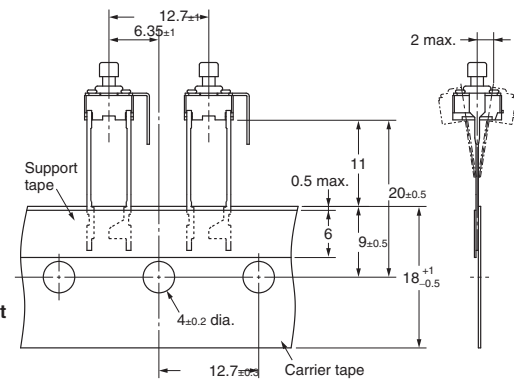
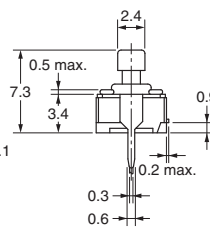
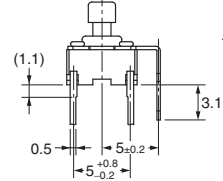
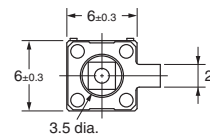
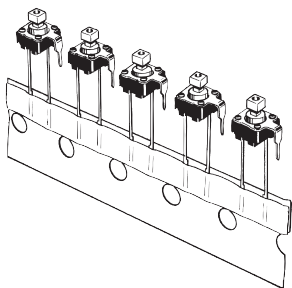

**PCB Mounting  
(Top View)  
(Single-sided PCB, t=1.6)**



**Terminal Arrangement  
/Internal Connections  
(Top View)**



# Hints on Correct Use

See the Tactile Switch User's Guide, "Tactile Switches - Technical Information" for information regarding processing and handling.

## ■ Taped Radial (Auto Insertion) Packaging

- Tactile switches packed on tape are placed into packing boxes as shown below.
- Number of switches per box: 1,000
- Tape may be drawn from the box either from the top or from the bottom.



## ■ Taping Strength

The tactile switches will not release from the tape when pulled in directions A and B at the following forces.

- A: 500 g
- B: 100 g



## Precautions

Be sure to read the precautions common to all Tactile Switches, contained in the Technical User's Guide, "Tactile Switches, Technical Information" for correct use.



All sales are subject to Omron Electronic Components LLC standard terms and conditions of sale, which can be found at [http://www.components.omron.com/components/web/webfiles.nsf/sales\\_terms.html](http://www.components.omron.com/components/web/webfiles.nsf/sales_terms.html)

**ALL DIMENSIONS SHOWN ARE IN MILLIMETERS.**  
To convert millimeters into inches, multiply by 0.03937. To convert grams into ounces, multiply by 0.03527.

---

**OMRON**<sup>®</sup>

**OMRON ELECTRONIC  
COMPONENTS LLC**

55 E. Commerce Drive, Suite B  
Schaumburg, IL 60173

**847-882-2288**

**OMRON ON-LINE**

Global - <http://www.omron.com>

USA - <http://www.components.omron.com>

Cat. No. X303-E-1a

08/11

Specifications subject to change without notice

Printed in USA

Компания «Life Electronics» занимается поставками электронных компонентов импортного и отечественного производства от производителей и со складов крупных дистрибьюторов Европы, Америки и Азии.

С конца 2013 года компания активно расширяет линейку поставок компонентов по направлению коаксиальный кабель, кварцевые генераторы и конденсаторы (керамические, пленочные, электролитические), за счёт заключения дистрибьюторских договоров

Мы предлагаем:

- Конкурентоспособные цены и скидки постоянным клиентам.
- Специальные условия для постоянных клиентов.
- Подбор аналогов.
- Поставку компонентов в любых объемах, удовлетворяющих вашим потребностям.
- Приемлемые сроки поставки, возможна ускоренная поставка.
- Доставку товара в любую точку России и стран СНГ.
- Комплексную поставку.
- Работу по проектам и поставку образцов.
- Формирование склада под заказчика.
- Сертификаты соответствия на поставляемую продукцию (по желанию клиента).
- Тестирование поставляемой продукции.
- Поставку компонентов, требующих военную и космическую приемку.
- Входной контроль качества.
- Наличие сертификата ISO.

В составе нашей компании организован Конструкторский отдел, призванный помогать разработчикам, и инженерам.

Конструкторский отдел помогает осуществить:

- Регистрацию проекта у производителя компонентов.
- Техническую поддержку проекта.
- Защиту от снятия компонента с производства.
- Оценку стоимости проекта по компонентам.
- Изготовление тестовой платы монтаж и пусконаладочные работы.



Тел: +7 (812) 336 43 04 (многоканальный)

Email: [org@lifeelectronics.ru](mailto:org@lifeelectronics.ru)