

FEATURES

Wide bandwidth

60 MHz at gain of -1

33 MHz at gain of -10

Slew rate: 2000 V/ μ s

20 MHz full power bandwidth, 20 V p-p, $R_L = 500 \Omega$

Fast settling: 100 ns to 0.1% (10 V step)

Differential gain error: 0.03% at 4.4 MHz

Differential phase error: 0.16° at 4.4 MHz

Low offset voltage: 150 μ V maximum (B Grade)

Low quiescent current: 6.5 mA

Available in tape and reel in accordance with

EIA-481-A standard

APPLICATIONS

Flash ADC input amplifiers

High speed current DAC interfaces

Video buffers and cable drivers

Pulse amplifiers

GENERAL DESCRIPTION

The AD844 is a high speed monolithic operational amplifier fabricated using the Analog Devices, Inc., junction isolated complementary bipolar (CB) process. It combines high bandwidth and very fast signal response with excellent dc performance. Although optimized for use in current-to-voltage applications and as an inverting mode amplifier, it is also suitable for use in many noninverting applications.

The AD844 can be used in place of traditional op amps, but its current feedback architecture results in much better ac performance, high linearity, and an exceptionally clean pulse response.

This type of op amp provides a closed-loop bandwidth that is determined primarily by the feedback resistor and is almost independent of the closed-loop gain. The AD844 is free from the slew rate limitations inherent in traditional op amps and other current-feedback op amps. Peak output rate of change can be over 2000 V/ μ s for a full 20 V output step. Settling time is typically 100 ns to 0.1%, and essentially independent of gain. The AD844 can drive 50 Ω loads to ± 2.5 V with low distortion and is short-circuit protected to 80 mA.

The AD844 is available in four performance grades and three package options. In the 16-lead SOIC (RW) package, the AD844J is specified for the commercial temperature range of 0°C to 70°C.

FUNCTIONAL BLOCK DIAGRAMS

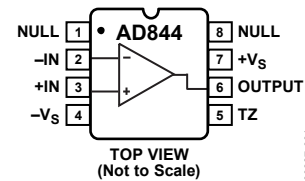

Figure 1. 8-Lead PDIP (N) and 8-Lead CERDIP (Q) Packages

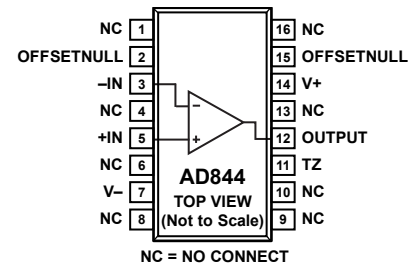

Figure 2. 16-Lead SOIC (R) Package

The AD844A and AD844B are specified for the industrial temperature range of -40°C to $+85^{\circ}\text{C}$ and are available in the CERDIP (Q) package. The AD844A is also available in an 8-lead PDIP (N). The AD844S is specified over the military temperature range of -55°C to $+125^{\circ}\text{C}$. It is available in the 8-lead CERDIP (Q) package. A and S grade chips and devices processed to MIL-STD-883B, Rev. C are also available.

PRODUCT HIGHLIGHTS

1. The AD844 is a versatile, low cost component providing an excellent combination of ac and dc performance.
2. It is essentially free from slew rate limitations. Rise and fall times are essentially independent of output level.
3. The AD844 can be operated from ± 4.5 V to ± 18 V power supplies and is capable of driving loads down to 50 Ω , as well as driving very large capacitive loads using an external network.
4. The offset voltage and input bias currents of the AD844 are laser trimmed to minimize dc errors; V_{OS} drift is typically 1 $\mu\text{V}/^{\circ}\text{C}$ and bias current drift is typically 9 nA/ $^{\circ}\text{C}$.
5. The AD844 exhibits excellent differential gain and differential phase characteristics, making it suitable for a variety of video applications with bandwidths up to 60 MHz.
6. The AD844 combines low distortion, low noise, and low drift with wide bandwidth, making it outstanding as an input amplifier for flash analog-to-digital converters (ADCs).

Rev. G

Document Feedback

Information furnished by Analog Devices is believed to be accurate and reliable. However, no responsibility is assumed by Analog Devices for its use, nor for any infringements of patents or other rights of third parties that may result from its use. Specifications subject to change without notice. No license is granted by implication or otherwise under any patent or patent rights of Analog Devices. Trademarks and registered trademarks are the property of their respective owners.

TABLE OF CONTENTS

Features	1	Response as an Inverting Amplifier	12
Applications	1	Response as an I-V Converter	13
Functional Block Diagrams	1	Circuit Description of the AD844	13
General Description	1	Response as a Noninverting Amplifier	14
Product Highlights	1	Noninverting Gain of 100	14
Revision History	2	Using the AD844	15
Specifications	3	Board Layout	15
Absolute Maximum Ratings	5	Input Impedance	15
Metallization Photograph	5	Driving Large Capacitive Loads	15
ESD Caution	5	Settling Time	15
Typical Performance Characteristics	6	DC Error Calculation	16
Inverting Gain-of-1 AC Characteristics	8	Noise	16
Inverting Gain-of-10 AC Characteristics	9	Video Cable Driver Using ± 5 V Supplies	16
Inverting Gain-of-10 Pulse Response	10	High Speed DAC Buffer	17
Noninverting Gain-of-10 AC Characteristics	11	20 MHz Variable Gain Amplifier	17
Understanding the AD844	12	Outline Dimensions	19
Open-Loop Behavior	12	Ordering Guide	20

REVISION HISTORY

5/2017—Rev. F to Rev. G

Change to Figure 32	14
---------------------------	----

2/2009—Rev. E to Rev F

Updated Format	Universal
Changes to Features Section	1
Changes to Differential Phase Error Parameter, Table 1	3
Changes to Figure 13	8
Changes to Figure 18	9
Changes to Figure 23 and Figure 24	11
Changes to Figure 42 and High Speed DAC Buffer Section	17
Updated Outline Dimensions	19
Changes to Ordering Guide	20

1/2003—Rev. D to Rev. E

Updated Features	1
Edit to TPC 18	7
Edits to Figure 13 and Figure 14	13
Updated Outline Dimensions	15

11/2001—Rev. C to Rev. D

Edits to Specifications	2
Edits to Absolute Maximum Ratings	3
Edits to Ordering Guide	3

SPECIFICATIONS

$T_A = 25^\circ\text{C}$ and $V_S = \pm 15\text{ V}$ dc, unless otherwise noted.

Table 1.

Parameter	Conditions	AD844J/AD844A			AD844B			AD844S			Unit	
		Min	Typ	Max	Min	Typ	Max	Min	Typ	Max		
INPUT OFFSET VOLTAGE ¹			50	300		50	150		50	300	μV	
T_{MIN} to T_{MAX}			75	500		75	200		125	500	μV	
vs. Temperature			1			1	5		1	5	$\mu\text{V}/^\circ\text{C}$	
vs. Supply	5 V to 18 V											
Initial			4	20		4	10		4	20	$\mu\text{V}/\text{V}$	
T_{MIN} to T_{MAX}			4			4	10		4	20	$\mu\text{V}/\text{V}$	
vs. Common Mode	$V_{\text{CM}} = \pm 10\text{ V}$											
Initial			10	35		10	20		10	35	$\mu\text{V}/\text{V}$	
T_{MIN} to T_{MAX}			10			10	20		10	35	$\mu\text{V}/\text{V}$	
INPUT BIAS CURRENT												
Negative Input Bias Current ¹			200	450		150	250		200	450	nA	
T_{MIN} to T_{MAX}			800	1500		750	1100		1900	2500	nA	
vs. Temperature			9			9	15		20	30	$\text{nA}/^\circ\text{C}$	
vs. Supply	5 V to 18 V											
Initial			175	250		175	200		175	250	nA/V	
T_{MIN} to T_{MAX}			220			220	240		220	300	nA/V	
vs. Common Mode	$V_{\text{CM}} = \pm 10\text{ V}$											
Initial			90	160		90	110		90	160	nA/V	
T_{MIN} to T_{MAX}			110			110	150		120	200	nA/V	
Positive Input Bias Current ¹			150	400		100	200		100	400	nA	
T_{MIN} to T_{MAX}			350	700		300	500		800	1300	nA	
vs. Temperature			3			3	7		7	15	$\text{nA}/^\circ\text{C}$	
vs. Supply	5 V to 18 V											
Initial			80	150		80	100		80	150	nA/V	
T_{MIN} to T_{MAX}			100			100	120		120	200	nA/V	
vs. Common Mode	$V_{\text{CM}} = \pm 10\text{ V}$											
Initial			90	150		90	120		90	150	nA/V	
T_{MIN} to T_{MAX}			130			130	190		140	200	nA/V	
INPUT CHARACTERISTICS												
Input Resistance												
Negative Input				50	65		50	65		50	65	Ω
Positive Input		7	10			7	10		7	10	$\text{M}\Omega$	
Input Capacitance												
Negative Input				2			2			2	pF	
Positive Input				2			2			2	pF	
Input Common-Mode Voltage Range			± 10			± 10			± 10		V	
INPUT VOLTAGE NOISE	$f \geq 1\text{ kHz}$		2			2			2		$\text{nV}/\sqrt{\text{Hz}}$	
INPUT CURRENT NOISE												
Negative Input	$f \geq 1\text{ kHz}$		10			10			10		$\text{pV}/\sqrt{\text{Hz}}$	
Positive Input	$f \geq 1\text{ kHz}$		12			12			12		$\text{pV}/\sqrt{\text{Hz}}$	
OPEN-LOOP TRANSRESISTANCE	$V_{\text{OUT}} = \pm 10\text{ V}$ $R_L = 500\ \Omega$											
T_{MIN} to T_{MAX}		2.2	3.0		2.8	3.0		2.2	3.0		$\text{M}\Omega$	
Transcapacitance		1.3	2.0		1.6	2.0		1.3	1.6		$\text{M}\Omega$	
			4.5			4.5			4.5		pF	
DIFFERENTIAL GAIN ERROR ²	$f = 4.4\text{ MHz}$		0.03			0.03			0.03		%	
DIFFERENTIAL PHASE ERROR ²	$f = 4.4\text{ MHz}$		0.16			0.16			0.16		Degree	

Parameter	Conditions	AD844J/AD844A			AD844B			AD844S			Unit
		Min	Typ	Max	Min	Typ	Max	Min	Typ	Max	
FREQUENCY RESPONSE											
Small Signal Bandwidth ^{3,4}											
Gain = -1			60		60		60		60		MHz
Gain = -10			33		33		33		33		MHz
TOTAL HARMONIC DISTORTION	f = 100 kHz, 2 V rms ⁵		0.005		0.005		0.005		0.005		%
SETTLING TIME											
10 V Output Step	±15 V supplies										
Gain = -1, to 0.1% ⁵			100		100		100		100		ns
Gain = -10, to 0.1% ⁶			100		100		100		100		ns
2 V Output Step	±5 V supplies										
Gain = -1, to 0.1% ⁵			110		110		110		110		ns
Gain = -10, to 0.1% ⁶			100		100		100		100		ns
OUTPUT SLEW RATE	Overdriven input	1200	2000		1200	2000		1200	2000		V/μs
FULL POWER BANDWIDTH	THD = 3%										
V _{OUT} = 20 V p-p ⁵	V _S = ±15 V		20		20		20		20		MHz
V _{OUT} = 2 V p-p ⁵	V _S = ±5 V		20		20		20		20		MHz
OUTPUT CHARACTERISTICS											
Voltage	R _L = 500 Ω	±10	±11		±10	±11		±10	±11		V
Short-Circuit Current			80		80		80		80		mA
T _{MIN} to T _{MAX}			60		60		60		60		mA
Output Resistance	Open loop		15		15		15		15		Ω
POWER SUPPLY											
Operating Range		±4.5		±18	±4.5		±18	±4.5		±18	V
Quiescent Current			6.5	7.5		6.5	7.5		6.5	7.5	mA
T _{MIN} to T _{MAX}			7.5	8.5		7.5	8.5		7.5	8.5	mA

¹ Rated performance after a 5 minute warm-up at T_A = 25°C.

² Input signal 285 mV p-p carrier (40 IRE) riding on 0 mV to 642 mV (90 IRE) ramp. R_L = 100 Ω; R₁, R₂ = 300 Ω.

³ For gain = -1, input signal = 0 dBm, C_L = 10 pF, R_L = 500 Ω, R₁ = 500 Ω, and R₂ = 500 Ω in Figure 29.

⁴ For gain = -10, input signal = 0 dBm, C_L = 10 pF, R_L = 500 Ω, R₁ = 500 Ω, and R₂ = 50 Ω in Figure 29.

⁵ C_L = 10 pF, R_L = 500 Ω, R₁ = 1 kΩ, R₂ = 1 kΩ in Figure 29.

⁶ C_L = 10 pF, R_L = 500 Ω, R₁ = 500 Ω, R₂ = 50 Ω in Figure 29.

ABSOLUTE MAXIMUM RATINGS

Table 2.

Parameter	Ratings
Supply Voltage	±18 V
Power Dissipation ¹	1.1 W
Output Short-Circuit Duration	Indefinite
Input Common-Mode Voltage	±V _S
Differential Input Voltage	6 V
Inverting Input Current	
Continuous	5 mA
Transient	10 mA
Storage Temperature Range (Q)	-65°C to +150°C
Storage Temperature Range (N, RW)	-65°C to +125°C
Lead Temperature (Soldering, 60 sec)	300°C
ESD Rating	1000 V

¹ 28-lead PDIP package: $\theta_{JA} = 90^{\circ}\text{C}/\text{W}$.
 8-lead CERDIP package: $\theta_{JA} = 110^{\circ}\text{C}/\text{W}$.
 16-lead SOIC package: $\theta_{JA} = 100^{\circ}\text{C}/\text{W}$.

Stresses at or above those listed under Absolute Maximum Ratings may cause permanent damage to the product. This is a stress rating only; functional operation of the product at these or any other conditions above those indicated in the operational section of this specification is not implied. Operation beyond the maximum operating conditions for extended periods may affect product reliability.

METALLIZATION PHOTOGRAPH

Contact factory for latest dimensions.

Dimensions shown in inches and (millimeters).



ESD CAUTION



ESD (electrostatic discharge) sensitive device. Charged devices and circuit boards can discharge without detection. Although this product features patented or proprietary protection circuitry, damage may occur on devices subjected to high energy ESD. Therefore, proper ESD precautions should be taken to avoid performance degradation or loss of functionality.

TYPICAL PERFORMANCE CHARACTERISTICS

$T_A = 25^\circ\text{C}$ and $V_S = \pm 15\text{ V}$, unless otherwise noted.



Figure 4. -3 dB Bandwidth vs. Supply Voltage, $R_1 = R_2 = 500\ \Omega$

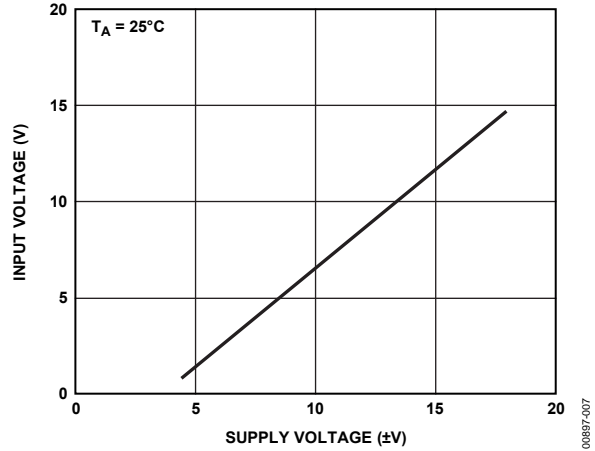

Figure 7. Noninverting Input Voltage Swing vs. Supply Voltage



Figure 5. Harmonic Distortion vs. Input Frequency, $R_1 = R_2 = 1\ \text{k}\Omega$

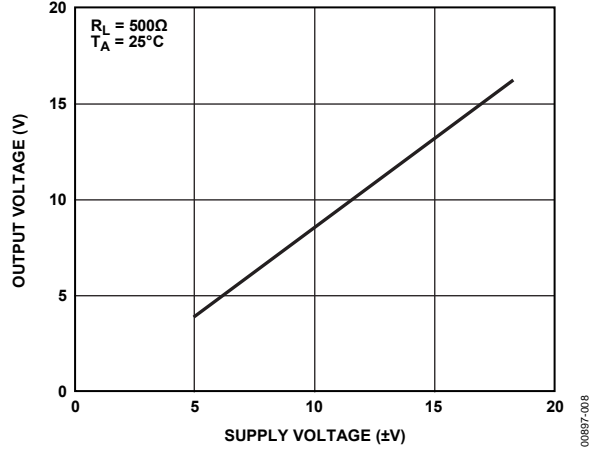

Figure 8. Output Voltage Swing vs. Supply Voltage



Figure 6. Transresistance vs. Temperature

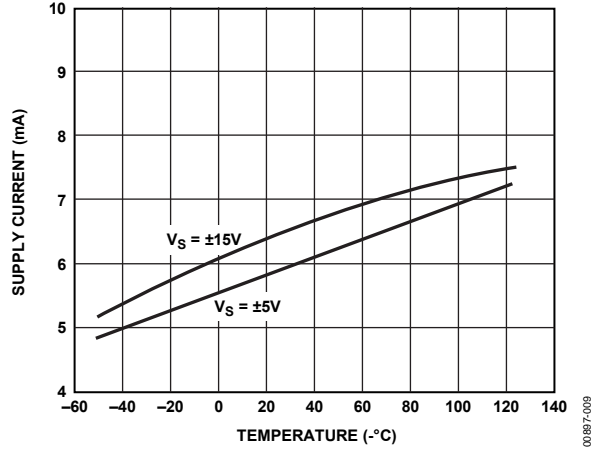

Figure 9. Quiescent Supply Current vs. Temperature and Supply Voltage



Figure 10. Inverting Input Bias Current (I_{BN}) and Noninverting Input Bias Current (I_{BP}) vs. Temperature



Figure 12. -3 dB Bandwidth vs. Temperature, Gain = -1, $R_1 = R_2 = 1\text{ k}\Omega$



Figure 11. Output Impedance vs. Frequency, Gain = -1, $R_1 = R_2 = 1\text{ k}\Omega$

INVERTING GAIN-OF-1 AC CHARACTERISTICS



Figure 13. Inverting Amplifier, Gain of -1 ($R_1 = R_2$)

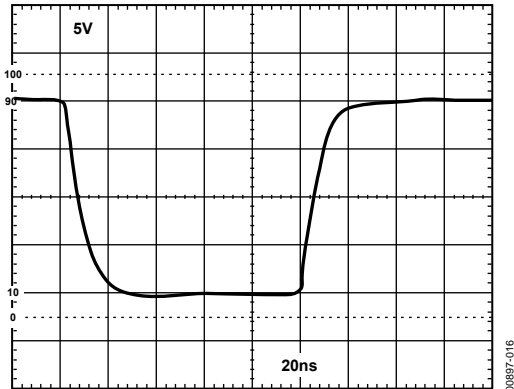

Figure 16. Large Signal Pulse Response, Gain = -1, $R_1 = R_2 = 1\text{ k}\Omega$



Figure 14. Gain vs. Frequency for Gain = -1, $R_L = 500\ \Omega$, $C_L = 0\text{ pF}$



Figure 15. Phase vs. Frequency for Gain = -1, $R_L = 500\ \Omega$, $C_L = 0\text{ pF}$

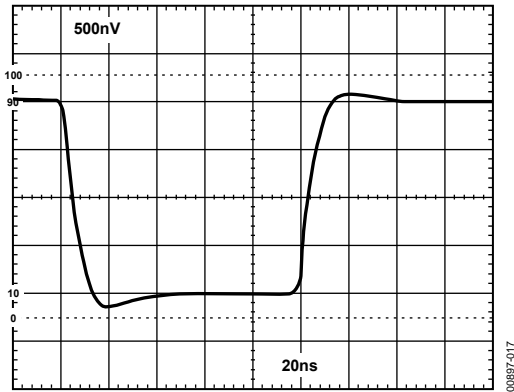

Figure 17. Small Signal Pulse Response, Gain = -1, $R_1 = R_2 = 1\text{ k}\Omega$

INVERTING GAIN-OF-10 AC CHARACTERISTICS



Figure 18. Gain of -10 Amplifier



Figure 19. Gain vs. Frequency, Gain = -10



Figure 20. Phase vs. Frequency, Gain = -10

INVERTING GAIN-OF-10 PULSE RESPONSE



Figure 21. Large Signal Pulse Response, Gain = -10, $R_L = 500 \Omega$



Figure 22. Small Signal Pulse Response, Gain = -10, $R_L = 500 \Omega$

NONINVERTING GAIN-OF-10 AC CHARACTERISTICS



Figure 23. Noninverting Gain of +10 Amplifier



Figure 26. Noninverting Amplifier Large Signal Pulse Response, Gain = +10, $R_L = 500\Omega$



Figure 24. Gain vs. Frequency, Gain = +10



Figure 27. Small Signal Pulse Response, Gain = +10, $R_L = 500\Omega$



Figure 25. Phase vs. Frequency, Gain = +10

UNDERSTANDING THE AD844

The AD844 can be used in ways similar to a conventional op amp while providing performance advantages in wideband applications. However, there are important differences in the internal structure that need to be understood to optimize the performance of the AD844 op amp.

OPEN-LOOP BEHAVIOR

Figure 28 shows a current feedback amplifier reduced to essentials. Sources of fixed dc errors, such as the inverting node bias current and the offset voltage, are excluded from this model. The most important parameter limiting the dc gain is the transresistance, R_t , which is ideally infinite. A finite value of R_t is analogous to the finite open-loop voltage gain in a conventional op amp.

The current applied to the inverting input node is replicated by the current conveyor to flow in Resistor R_t . The voltage developed across R_t is buffered by the unity gain voltage follower. Voltage gain is the ratio R_t/R_{IN} . With typical values of $R_t = 3 \text{ M}\Omega$ and $R_{IN} = 50 \Omega$, the voltage gain is about 60,000. The open-loop current gain, another measure of gain that is determined by the beta product of the transistors in the voltage follower stage (see Figure 31), is typically 40,000.

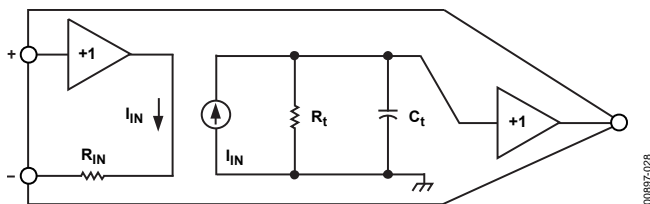

Figure 28. Equivalent Schematic

The important parameters defining ac behavior are the transcapacitance, C_t , and the external feedback resistor (not shown). The time constant formed by these components is analogous to the dominant pole of a conventional op amp and thus cannot be reduced below a critical value if the closed-loop system is to be stable. In practice, C_t is held to as low a value as possible (typically 4.5 pF) so that the feedback resistor can be maximized while maintaining a fast response. The finite R_{IN} also affects the closed-loop response in some applications.

The open-loop ac gain is also best understood in terms of the transimpedance rather than as an open-loop voltage gain. The open-loop pole is formed by R_t in parallel with C_t . Because C_t is typically 4.5 pF, the open-loop corner frequency occurs at about 12 kHz. However, this parameter is of little value in determining the closed-loop response.

RESPONSE AS AN INVERTING AMPLIFIER

Figure 29 shows the connections for an inverting amplifier. Unlike a conventional amplifier, the transient response and the small signal bandwidth are determined primarily by the value of the external feedback resistor, R_1 , rather than by the ratio of R_1/R_2 as is customarily the case in an op amp application. This is a direct result of the low impedance at the inverting input. As with conventional op amps, the closed-loop gain is $-R_1/R_2$.

The closed-loop transresistance is the parallel sum of R_1 and R_t . Because R_1 is generally in the range of 500 Ω to 2 k Ω and R_t is about 3 M Ω , the closed-loop transresistance is only 0.02% to 0.07% lower than R_1 . This small error is often less than the resistor tolerance.

When R_1 is fairly large (above 5 k Ω) but still much less than R_t , the closed-loop HF response is dominated by the time constant $R_1 C_t$. Under such conditions, the AD844 is overdamped and provides only a fraction of its bandwidth potential. Because of the absence of slew rate limitations under these conditions, the circuit exhibits a simple single-pole response even under large signal conditions.

In Figure 29, R_3 is used to properly terminate the input if desired. R_3 in parallel with R_2 gives the terminated resistance. As R_1 is lowered, the signal bandwidth increases, but the time constant $R_1 C_t$ becomes comparable to higher order poles in the closed-loop response. Therefore, the closed-loop response becomes complex, and the pulse response shows overshoot. When R_2 is much larger than the input resistance, R_{IN} , at Pin 2, most of the feedback current in R_1 is delivered to this input, but as R_2 becomes comparable to R_{IN} , less of the feedback is absorbed at Pin 2, resulting in a more heavily damped response. Consequently, for low values of R_2 , it is possible to lower R_1 without causing instability in the closed-loop response. Table 3 lists combinations of R_1 and R_2 and the resulting frequency response for the circuit of Figure 29. Figure 16 shows the very clean and fast $\pm 10 \text{ V}$ pulse response of the AD844.

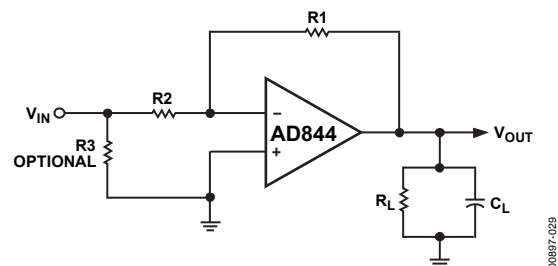

Figure 29. Inverting Amplifier

Table 3. Gain vs. Bandwidth

Gain	R1	R2	BW (MHz)	GBW (MHz)
-1	1 kΩ	1 kΩ	35	35
-1	500 Ω	500 Ω	60	60
-2	2 kΩ	1 kΩ	15	30
-2	1 kΩ	500 Ω	30	60
-5	5 kΩ	1 kΩ	5.2	26
-5	500 Ω	100 Ω	49	245
-10	1 kΩ	100 Ω	23	230
-10	500 Ω	50 Ω	33	330
-20	1 kΩ	50 Ω	21	420
-100	5 kΩ	50 Ω	3.2	320

RESPONSE AS AN I-V CONVERTER

The AD844 works well as the active element in an operational current-to-voltage converter, used in conjunction with an external scaling resistor, R1, in Figure 30. This analysis includes the stray capacitance, Cs, of the current source, which may be a high speed DAC. Using a conventional op amp, this capacitance forms a nuisance pole with R1 that destabilizes the closed-loop response of the system. Most op amps are internally compensated for the fastest response at unity gain, so the pole due to R1 and Cs reduces the already narrow phase margin of the system. For example, if R1 is 2.5 kΩ, a Cs of 15 pF places this pole at a frequency of about 4 MHz, well within the response range of even a medium speed operational amplifier. In a current feedback amp, this nuisance pole is no longer determined by R1 but by the input resistance, Rin. Because this is about 50 Ω for the AD844, the same 15 pF forms a pole at 212 MHz and causes little trouble. It can be shown that the response of this system is:

$$V_{OUT} = I_{sig} \frac{K R1}{(1 + s_{Td})(1 + s_{Tn})}$$

where:

K is a factor very close to unity and represents the finite dc gain of the amplifier.

Td is the dominant pole.

Tn is the nuisance pole.

$$K = \frac{R_t}{R_t + R1}$$

$$Td = KR1C_t$$

$$Tn = R_{IN}C_s \text{ (assuming } R_{IN} \ll R1)$$

Using typical values of R1 = 1 kΩ and Rt = 3 MΩ, K = 0.9997; in other words, the gain error is only 0.03%. This is much less than the scaling error of virtually all DACs and can be absorbed, if necessary, by the trim needed in a precise system.

In the AD844, Rt is fairly stable with temperature and supply voltages, and consequently the effect of finite gain is negligible unless high value feedback resistors are used. Because that results in slower response times than are possible, the relatively low value of Rt in the AD844 is rarely a significant source of error.



Figure 30. Current-to-Voltage Converter

CIRCUIT DESCRIPTION OF THE AD844

A simplified schematic is shown in Figure 31. The AD844 differs from a conventional op amp in that the signal inputs have radically different impedance. The noninverting input (Pin 3) presents the usual high impedance. The voltage on this input is transferred to the inverting input (Pin 2) with a low offset voltage, ensured by the close matching of like polarity transistors operating under essentially identical bias conditions. Laser trimming nulls the residual offset voltage, down to a few tens of microvolts. The inverting input is the common emitter node of a complementary pair of grounded base stages and behaves as a current summing node. In an ideal current feedback op amp, the input resistance is zero. In the AD844, it is about 50 Ω.

A current applied to the inverting input is transferred to a complementary pair of unity-gain current mirrors that deliver the same current to an internal node (Pin 5) at which the full output voltage is generated. The unity-gain complementary voltage follower then buffers this voltage and provides the load driving power. This buffer is designed to drive low impedance loads, such as terminated cables, and can deliver ±50 mA into a 50 Ω load while maintaining low distortion, even when operating at supply voltages of only ±6 V. Current limiting (not shown) ensures safe operation under short-circuited conditions.



Figure 31. Simplified Schematic

It is important to understand that the low input impedance at the inverting input is locally generated and does not depend on feedback. This is very different from the virtual ground of a conventional operational amplifier used in the current summing mode, which is essentially an open circuit until the loop settles. In the AD844, transient current at the input does not cause voltage spikes at the summing node while the amplifier is settling. Furthermore, all of the transient current is delivered to the slewing (TZ) node (Pin 5) via a short signal path (the grounded base stages and the wideband current mirrors).

The current available to charge the capacitance (about 4.5 pF) at the TZ node is always proportional to the input error current, and the slew rate limitations associated with the large signal response of the op amps do not occur. For this reason, the rise and fall times are almost independent of signal level. In practice, the input current eventually causes the mirrors to saturate. When using ± 15 V supplies, this occurs at about 10 mA (or ± 2200 V/ μ s). Because signal currents are rarely this large, classical slew rate limitations are absent.

This inherent advantage is lost if the voltage follower used to buffer the output has slew rate limitations. The AD844 is designed to avoid this problem, and as a result, the output buffer exhibits a clean large signal transient response, free from anomalous effects arising from internal saturation.

RESPONSE AS A NONINVERTING AMPLIFIER

Because current feedback amplifiers are asymmetrical with regard to their two inputs, performance differs markedly in noninverting and inverting modes. In noninverting modes, the large signal high speed behavior of the AD844 deteriorates at low gains because the biasing circuitry for the input system (not shown in Figure 31) is not designed to provide high input voltage slew rates.

However, good results can be obtained with some care. The noninverting input does not tolerate a large transient input; it must be kept below ± 1 V for best results. Consequently, this mode is better suited to high gain applications (greater than $\times 10$). Figure 23 shows a noninverting amplifier with a gain of 10 and a bandwidth of 30 MHz. The transient response is shown in Figure 26 and Figure 27. To increase the bandwidth at higher gains, a capacitor can be added across R2 whose value is approximately $(R1/R2) \times C_i$.

NONINVERTING GAIN OF 100

The AD844 provides very clean pulse response at high noninverting gains. Figure 32 shows a typical configuration providing a gain of 100 with high input resistance. The feedback resistor is kept as low as practicable to maximize bandwidth, and a peaking capacitor (C_{PK}) can optionally be added to further extend the bandwidth. Figure 33 shows the small signal response with $C_{PK} = 3$ nF, $R_L = 500 \Omega$, and supply voltages of either ± 5 V or ± 15 V. Gain bandwidth products of up to 900 MHz can be achieved in this way.

The offset voltage of the AD844 is laser trimmed to the 50 μ V level and exhibits very low drift. In practice, there is an additional offset term due to the bias current at the inverting input (I_{BN}), which flows in the feedback resistor (R1). This can optionally be nulled by the trimming potentiometer shown in Figure 32.

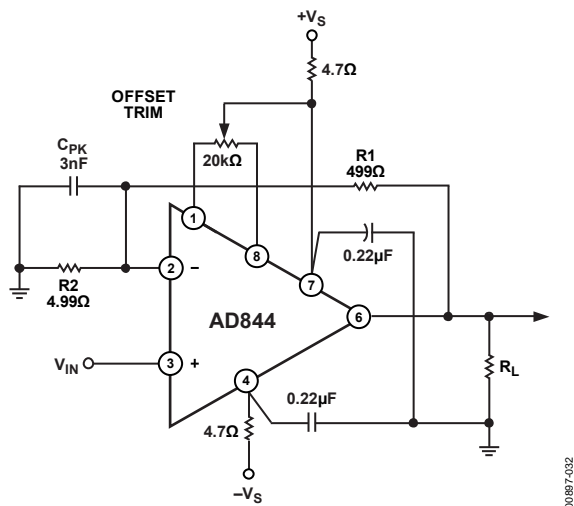

Figure 32. Noninverting Amplifier Gain = 100, Optional Offset Trim Is Shown

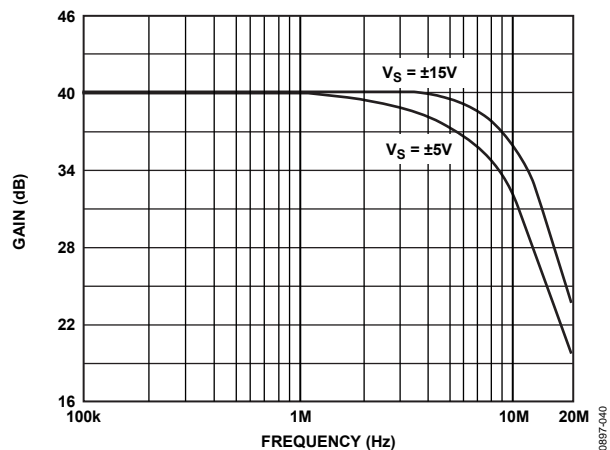

Figure 33. AC Response for Gain = 100, Configuration Shown in Figure 32

USING THE AD844 BOARD LAYOUT

As with all high frequency circuits considerable care must be used in the layout of the components surrounding the AD844. A ground plane, to which the power supply decoupling capacitors are connected by the shortest possible leads, is essential to achieving clean pulse response. Even a continuous ground plane exhibits finite voltage drops between points on the plane, and this must be kept in mind when selecting the grounding points. In general, decoupling capacitors should be taken to a point close to the load (or output connector) because the load currents flow in these capacitors at high frequencies. The +IN and -IN circuits (for example, a termination resistor and Pin 3) must be taken to a common point on the ground plane close to the amplifier package.

Use low impedance 0.22 μF capacitors (AVX SR305C224KAA or equivalent) wherever ac coupling is required. Include either ferrite beads and/or a small series resistance (approximately 4.7 Ω) in each supply line.

INPUT IMPEDANCE

At low frequencies, negative feedback keeps the resistance at the inverting input close to zero. As the frequency increases, the impedance looking into this input increases from near zero to the open-loop input resistance, due to bandwidth limitations, making the input seem inductive. If it is desired to keep the input impedance flatter, a series RC network can be inserted across the input. The resistor is chosen so that the parallel sum of it and R2 equals the desired termination resistance. The capacitance is set so that the pole determined by this RC network is about half the bandwidth of the op amp. This network is not important if the input resistor is much larger than the termination used, or if frequencies are relatively low. In some cases, the small peaking that occurs without the network can be of use in extending the -3 dB bandwidth.

DRIVING LARGE CAPACITIVE LOADS

Capacitive drive capability is 100 pF without an external network. With the addition of the network shown in Figure 34, the capacitive drive can be extended to over 10,000 pF, limited by internal power dissipation. With capacitive loads, the output speed becomes a function of the overdriven output current limit. Because this is roughly ± 100 mA, under these conditions, the maximum slew rate into a 1000 pF load is ± 100 V/ μs . Figure 35 shows the transient response of an inverting amplifier ($R_1 = R_2 = 1$ k Ω) using the feedforward network shown in Figure 34, driving a load of 1000 pF.



Figure 34. Feedforward Network for Large Capacitive Loads

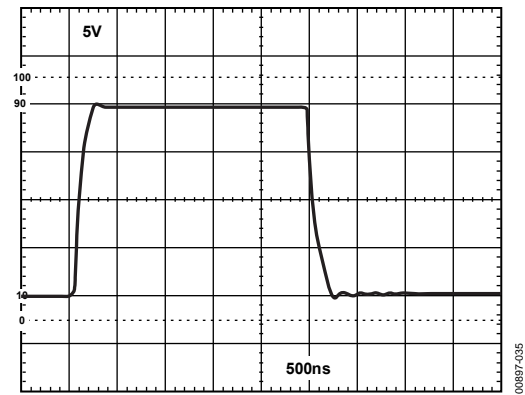

Figure 35. Driving 1000 pF C_L with Feedforward Network of Figure 34

SETTLING TIME

Settling time is measured with the circuit of Figure 36. This circuit employs a false summing node, clamped by the two Schottky diodes, to create the error signal and limit the input signal to the oscilloscope. For measuring settling time, the ratio of R_6/R_5 is equal to R_1/R_2 . For unity gain, $R_6 = R_5 = 1$ k Ω , and $R_L = 500$ Ω . For the gain of -10, $R_5 = 50$ Ω , $R_6 = 500$ Ω , and R_L was not used because the summing network loads the output with approximately 275 Ω . Using this network in a unity-gain configuration, settling time is 100 ns to 0.1% for a -5 V to +5 V step with $C_L = 10$ pF.



- NOTES
1. D1, D2 IN6263 OR EQUIVALENT SCHOTTKY DIODE.

Figure 36. Settling Time Test Fixture

DC ERROR CALCULATION

Figure 37 shows a model of the dc error and noise sources for the AD844. The inverting input bias current, I_{BN} , flows in the feedback resistor. I_{BP} , the noninverting input bias current, flows in the resistance at Pin 3 (R_P), and the resulting voltage (plus any offset voltage) appears at the inverting input. The total error, V_O , at the output is:

$$V_O = (I_{BP}R_P + V_{OS} + I_{BN}R_{IN}) \left(1 + \frac{R1}{R2}\right) + I_{BN}R1$$

Because I_{BN} and I_{BP} are unrelated both in sign and magnitude, inserting a resistor in series with the noninverting input does not necessarily reduce dc error and may actually increase it.



Figure 37. Offset Voltage and Noise Model for the AD844

NOISE

Noise sources can be modeled in a manner similar to the dc bias currents, but the noise sources are I_{NN} , I_{NP} , V_N , and the amplifier induced noise at the output, V_{ON} , is:

$$V_{ON} = \sqrt{\left(\left(I_{NP}R_P\right)^2 + V_N^2\right)\left(1 + \frac{R1}{R2}\right)^2 + \left(I_{NN}R1\right)^2}$$

Overall noise can be reduced by keeping all resistor values to a minimum. With typical numbers, $R1 = R2 = 1\text{ k}\Omega$, $R_P = 0\ \Omega$, $V_N = 2\text{ nV}/\sqrt{\text{Hz}}$, $I_{NP} = 10\text{ pA}/\sqrt{\text{Hz}}$, $I_{NN} = 12\text{ pA}/\sqrt{\text{Hz}}$, and V_{ON} calculates to $12\text{ nV}/\sqrt{\text{Hz}}$. The current noise is dominant in this case, because it is in most low gain applications.

VIDEO CABLE DRIVER USING $\pm 5\text{ V}$ SUPPLIES

The AD844 can be used to drive low impedance cables. Using $\pm 5\text{ V}$ supplies, a $100\ \Omega$ load can be driven to $\pm 2.5\text{ V}$ with low distortion. Figure 38 shows an illustrative application that provides a noninverting gain of +2, allowing the cable to be reverse-terminated while delivering an overall gain of +1 to the load. The -3 dB bandwidth of this circuit is typically 30 MHz . Figure 39 shows a differential gain and phase test setup. In video applications, differential-phase and differential-gain characteristics are often important. Figure 40 shows the variation in phase as the load voltage varies. Figure 41 shows the gain variation.



Figure 38. The AD844 as a Cable Driver



Figure 39. Differential Gain/Phase Test Setup



Figure 40. Differential Phase for the Circuit of Figure 38



Figure 41. Differential Gain for the Circuit of Figure 38



*POWER SUPPLY BYPASS CAPACITORS.

Figure 42. High Speed DAC Amplifier

HIGH SPEED DAC BUFFER

The AD844 performs very well in applications requiring current-to-voltage conversion. Figure 42 shows connections for use with the AD568 current output DAC. In this application, the bipolar offset is used so that the full-scale current is ±5.12 mA, which generates an output of ±5.12 V using the 1 kΩ application resistor on the AD568. Figure 43 shows the full-scale transient response. Care is needed in power supply decoupling and grounding techniques to achieve the full 12-bit accuracy and realize the fast settling capabilities of the system. The AD568 data sheet should be consulted for more complete details about its use.

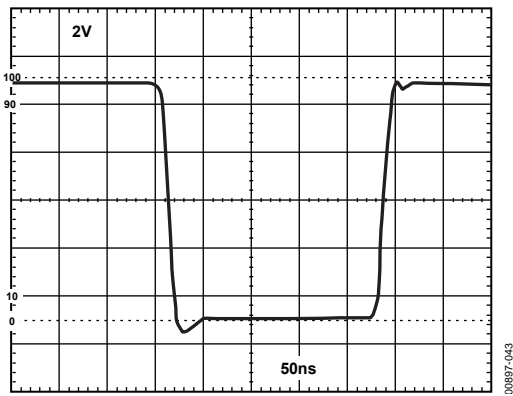

Figure 43. DAC Amplifier Full-Scale Transient Response

20 MHZ VARIABLE GAIN AMPLIFIER

The AD844 is an excellent choice as an output amplifier for the AD539 multiplier, in all of its connection modes. (See the AD539 data sheet for full details.) Figure 44 shows a simple multiplier providing the output:

$$V_w = -\frac{V_x V_y}{2V} \tag{1}$$

where V_x is the gain control input, a positive voltage from 0 V to 3.2 V (maximum), and V_y is the signal voltage, nominally ±2 V full scale but capable of operation up to ±4.2 V.

The peak output in this configuration is thus ±6.7 V. Using all four of the internal application resistors provided on the AD539 in parallel results in a feedback resistance of 1.5 kΩ, at which value the bandwidth of the AD844 is about 22 MHz, and is essentially independent of V_x . The gain at $V_x = 3.16$ V is 4 dB.



* V_x AND V_y INPUTS MAY OPTIONALLY BE TERMINATED; TYPICALLY BY USING A 50Ω OR 75Ω RESISTOR TO GROUND.

Figure 44. 20 MHz VGA Using the AD539

Figure 45 shows the small signal response for a 50 dB gain control range ($V_x = 10 \text{ mV}$ to 3.16 V). At small values of V_x , capacitive feedthrough on the PC board becomes troublesome and very careful layout techniques are needed to minimize this problem. A ground strip between the pins of the AD539 is helpful in this regard. Figure 46 shows the response to a 2 V pulse on V_Y for $V_x = 1 \text{ V}$, 2 V , and 3 V . For these results, a load resistor of 500Ω was used and the supplies were $\pm 9 \text{ V}$. The multiplier operates from supplies between $\pm 4.5 \text{ V}$ and $\pm 16.5 \text{ V}$.

Disconnecting Pin 9 and Pin 16 on the AD539 alters the denominator in Equation 1 to 1 V, and the bandwidth is approximately 10 MHz, with a maximum gain of 10 dB. Using only Pin 9 or Pin 16 results in a denominator of 0.5 V, a bandwidth of 5 MHz, and a maximum gain of 16 dB.



Figure 45. VGA AC Response



Figure 46. VGA Transient Response with $V_x = 1 \text{ V}$, 2 V , and 3 V

OUTLINE DIMENSIONS



COMPLIANT TO JEDEC STANDARDS MS-001
 CONTROLLING DIMENSIONS ARE IN INCHES; MILLIMETER DIMENSIONS (IN PARENTHESES) ARE ROUNDED-OFF INCH EQUIVALENTS FOR REFERENCE ONLY AND ARE NOT APPROPRIATE FOR USE IN DESIGN. CORNER LEADS MAY BE CONFIGURED AS WHOLE OR HALF LEADS.

Figure 47. 8-Lead Plastic Dual-in-Line Package [PDIP] (N-8)

Dimensions shown in inches and (millimeters)

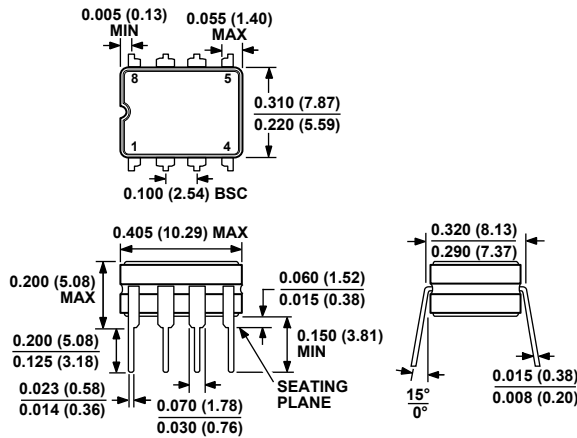

CONTROLLING DIMENSIONS ARE IN INCHES; MILLIMETER DIMENSIONS (IN PARENTHESES) ARE ROUNDED-OFF INCH EQUIVALENTS FOR REFERENCE ONLY AND ARE NOT APPROPRIATE FOR USE IN DESIGN.

Figure 48. 8-Lead Ceramic Dual In-Line Package [CERDIP] (Q-8)

Dimensions shown in inches and (millimeters)

070806-A

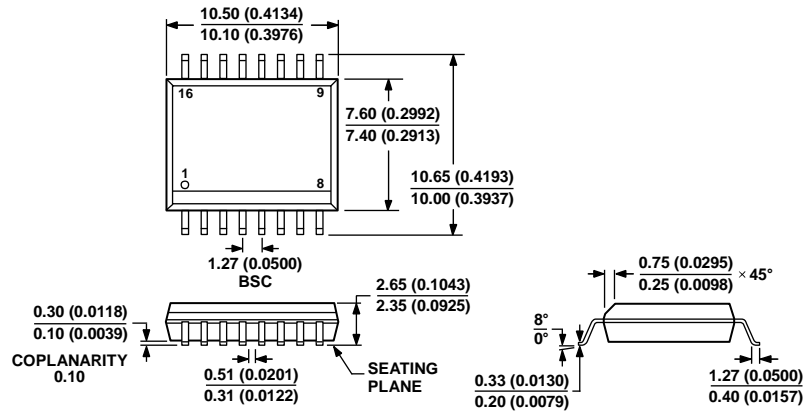

COMPLIANT TO JEDEC STANDARDS MS-013-AA
CONTROLLING DIMENSIONS ARE IN MILLIMETERS; INCH DIMENSIONS
(IN PARENTHESES) ARE ROUNDED-OFF MILLIMETER EQUIVALENTS FOR
REFERENCE ONLY AND ARE NOT APPROPRIATE FOR USE IN DESIGN.

Figure 49. 16-Lead Standard Small Outline Package [SOIC_W]
Wide Body
(RW-16)

Dimensions shown in millimeters and (inches)

032707-B

ORDERING GUIDE

Model	Temperature Range	Package Description	Package Option
AD844AN	-40°C to +85°C	8-Lead Plastic Dual In-Line Package [PDIP]	N-8
AD844ANZ ¹	-40°C to +85°C	8-Lead Plastic Dual In-Line Package [PDIP]	N-8
AD844ACHIPS	-40°C to +85°C		Die
AD844AQ	-40°C to +85°C	8-Lead Ceramic Dual In-Line Package [CERDIP]	Q-8
AD844BQ	-40°C to +85°C	8-Lead Ceramic Dual In-Line Package [CERDIP]	Q-8
AD844JRZ-16 ¹	0°C to 70°C	16-Lead Standard Small Outline Package [SOIC_W]	RW-16
AD844JRZ-16-REEL ⁷	0°C to 70°C	16-Lead SOIC_W, 7" Tape and Reel	RW-16
AD844SCHIPS	-55°C to +125°C		Die
AD844SQ	-55°C to +125°C	8-Lead Ceramic Dual In-Line Package [CERDIP]	Q-8
AD844SQ/883B	-55°C to +125°C	8-Lead Ceramic Dual In-Line Package [CERDIP]	Q-8
5962-8964401PA ²	-55°C to +125°C	8-Lead Ceramic Dual In-Line Package [CERDIP]	Q-8

¹ Z = RoHS Compliant Part.

² Refer to the DESC drawing for tested specifications.

Компания «Life Electronics» занимается поставками электронных компонентов импортного и отечественного производства от производителей и со складов крупных дистрибьюторов Европы, Америки и Азии.

С конца 2013 года компания активно расширяет линейку поставок компонентов по направлению коаксиальный кабель, кварцевые генераторы и конденсаторы (керамические, пленочные, электролитические), за счёт заключения дистрибьюторских договоров

Мы предлагаем:

- Конкурентоспособные цены и скидки постоянным клиентам.
- Специальные условия для постоянных клиентов.
- Подбор аналогов.
- Поставку компонентов в любых объемах, удовлетворяющих вашим потребностям.
- Приемлемые сроки поставки, возможна ускоренная поставка.
- Доставку товара в любую точку России и стран СНГ.
- Комплексную поставку.
- Работу по проектам и поставку образцов.
- Формирование склада под заказчика.
- Сертификаты соответствия на поставляемую продукцию (по желанию клиента).
- Тестирование поставляемой продукции.
- Поставку компонентов, требующих военную и космическую приемку.
- Входной контроль качества.
- Наличие сертификата ISO.

В составе нашей компании организован Конструкторский отдел, призванный помогать разработчикам, и инженерам.

Конструкторский отдел помогает осуществить:

- Регистрацию проекта у производителя компонентов.
- Техническую поддержку проекта.
- Защиту от снятия компонента с производства.
- Оценку стоимости проекта по компонентам.
- Изготовление тестовой платы монтаж и пусконаладочные работы.



Тел: +7 (812) 336 43 04 (многоканальный)
Email: org@lifeelectronics.ru