



## **EMC filters**

1-line filters

Feedthrough capacitors

Rated current 16 to 200 A







**Series/Type:**            **B85111, B85121**

Date:                        January 2006

## 1-line filters

### Feedthrough components

#### Overview of available types

Type	Dia- meter  mm	New	Rated current (A)	Rated voltage (VAC)	Rated capacitance ( $\mu$ F)	Terminal type	Insertion loss in the frequency range (Hz)			Page
							$10^5$	$10^6$	$10^7$	
<b>Feedthrough capacitors</b>										
B85121A*+160	16	●	16	75 ... 440	0.00125 ... 1.0					6
B85121A*+250	20	●	25	75 ... 440	0.01 ... 1.0	 				8
B85111A*B500	24	●	50	250	0.05					10
B85121A*A250 B85121A*A750	30	●	25, 75	250	0.1 ... 1.0					11
B85121A*A630, A101, A201	55	●	63 ... 200	250	0.5 ... 4.7					12

#### Legend

Terminal type:  Axial leads

 Threaded studs

### General

Feedthrough components from EPCOS are used for EMI suppression of all electrical installations and equipment. This new type series is also outstandingly well suited for telephone exchanges and base stations. Thanks to broadband EMI suppression up to the GHz range, it prevents external interference pulses being transmitted to the inside of the equipment via the supply network and vice-versa.

The essential features of this new type series are its modular design and the solder-free contacting technology developed by EPCOS with the aid of mesh contact.

Mesh contact technology permits uniform concentric contacting of the MKP capacitor winding and avoids the thermal stress associated with soldering. The result is an even higher insertion loss, a high insulation resistance and a particularly compact case.

The modular system used in this new technology for feedthrough capacitors and filters allows the cost-effective implementation of a wide range of standard types. Other capacitance values can also be supplied for special applications upon request.



Feedthrough components fitted into a shielding wall.

In feedthrough capacitors, the conductor carrying the operating current is connected concentrically to one electrode and is run centrally through the capacitor. The other electrode is contacted concentrically to the capacitor case.

Feedthrough capacitors are dimensioned so that they perform well from low frequencies to far above 300 MHz. The capacitor element with low inductance contacted securely on the face side is incorporated in a metal case provided with a screw thread.

The feedthrough filters are constructed in a  $\pi$ -circuit. They consist of two identical capacitive transverse elements and an inductive longitudinal element. The concentric layout of the components allows high insertion loss values to be attained in a frequency range to above 1 GHz.

### Safety note

Feedthrough components with high capacitances require the implementation of safety measures in line with the applicable specifications! (See also Chapter "Mounting instructions".)

## 1-line filters

### Feedthrough components

#### Mounting instructions

To fully utilize their RF properties, the feedthrough components must be mounted directly into shielding walls. The case must be contacted seamlessly (sealed against RF signals) to the shielding wall. This can be best done by screwing it into a threaded hole or bushing so that contact is made via the threads.

Alternatively, the feedthrough components may be screwed into feed-through holes on the shielding wall by means of attachment nuts. The contact between case and the shielding wall is then set up via the contact surface of the thread.

#### Caution

Contacts with rigid copper busbars are not permitted in view of mechanical stresses of the bushings due to impacts and vibrations.

For types with screw connections, the connecting cable must be secured between two nuts to exclude a torque on the feedthrough pins. The use of two flat wrenches is recommended.

#### Recommended tightening torques for feedthrough components (capacitors, filters)

Thread dimensions	Tightening torque (Nm)	Tolerance (Nm)	Terminal	Thread base attachment
M2	0.2	+0.05	×	
M3	0.6	+0.1	×	
M4	1.2	+0.1	×	
M5	2	+0.5	×	
M6	3	+0.5	×	
M8	5	+0.5	×	
M10	8	+2	×	
M12	12	+2	×	
M16	28	+2	×	
M18	35	+2	×	
M10 × 0.75	3	+0.5		×
M12 × 0.75	4	+0.5		×
M20 × 1	10	+1		×
M24 × 1.5	12	+1.5		×
M27 × 1.5	16	+2		×
M32 × 1.5	24	+2.5		×

**Feedthrough capacitors**

**Rated voltage 75 to 440 V AC**

**Rated current 16 to 200 A**

**Rated capacitance 0.00125 to 4.7  $\mu$ F**

**Construction**

- Building-block system
- MKP technology (dry, self-healing)  
Dielectric: polypropylene, metallized
- Metal case, polyurethane potting (UL 94 V-0)
- For central screw fixing

**Features**

- Compact dimensions
- High insertion loss
- Easy to install
- High contact reliability thanks to central screw fixing
- Comply with IEC 60384-14
- UL approval 

**Applications**

Broadband interference suppression  
for AC/DC supply lines, e.g. in

- shielded rooms
- telephone exchanges, base stations
- electrical machines and systems
- power supplies

**Terminals**

- Threaded studs
- Axial leads

**Marking**

Manufacturer, ordering code, rated capacitance,  
rated voltage, rated current, climatic category,  
circuit diagram, date of manufacture (MM.YY), approvals

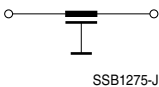
**Circuit diagram**

**Feedthrough capacitors ∅ 16 mm**
**Technical data and measuring conditions**

Rated voltage $V_R$	75 ... 440 V AC, 50/60 Hz 160 ... 600 V DC
Rated current $I_R$	Referred to 40 °C ambient temperature Reduced current values at 400 Hz
Capacitance tolerance	±20%
Climatic category (IEC 60068-1)	40/085/56 (−40 °C/+85 °C/56 days damp heat test)
Screw cap fixing	M10 × 0.75
Approvals	UL 1283, 250 V

**Characteristics and ordering codes**

$I_R$ A	$C_R$ μF	$V_R$ V AC	$V_R$ V DC	$V_{test}$ V DC	Terminal	Figure	Ordering code	Approvals 
16	0.00125	250	600	4000	Leads ∅ 2 mm	1	B85121A2122C160	×
	0.0025	440	600	4350			B85121A4252C160	×
	0.005	250	600	4000			B85121A2502C160	×
	0.010	250	600	1750			B85121A2103C160	×
	0.025	250	600	1750			B85121A2253C160	×
	0.05	250	600	1750			B85121A2503C160	×
	0.1	110	160	800			B85121A1104C160	–
	1.0	75	160	350			Leads ∅ 2 mm	2

× = approval granted

**Insertion loss (dB); typical values at 50 Ω**

$C_R$ (μF)	10 kHz	100 kHz	1 MHz	10 MHz	100 MHz	> 300 MHz
0.00125	–	–	–	6	35	> 40
0.0025	–	–	–	12	45	> 60
0.005	–	–	2	16	40	> 50
0.010	–	–	4	25	55	> 70
0.025	–	–	11	30	55	> 80
0.05	–	1	17	35	52	> 80
0.1	–	4	20	40	60	> 80
1.0	5	25	45	50	85	> 90

**Dimensional drawings**

**Figure 1, B85121A\*\*\*\*C160**

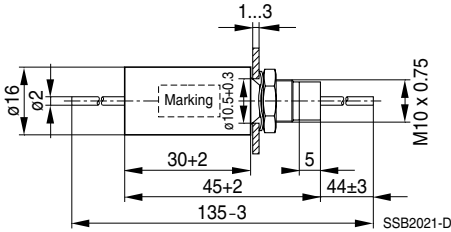

Tightening torque: 3 +0.5 Nm

**Figure 2, B85121A\*\*\*\*B160**

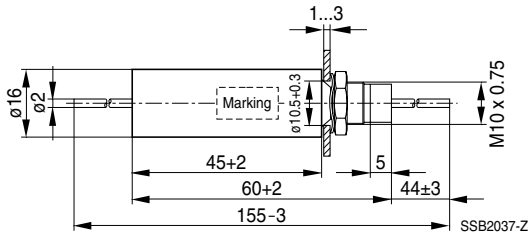

Tightening torque: 3 +0.5 Nm

**Feedthrough capacitors ∅ 20 mm**
**Technical data and measuring conditions**

Rated voltage $V_R$	75 ... 440 V AC, 50/60 Hz 160 ... 600 V DC
Rated current $I_R$	Referred to 40 °C ambient temperature Reduced current values at 400 Hz
Capacitance tolerance	±20%
Climatic category (IEC 60068-1)	40/085/56 (−40 °C/+85 °C/56 days damp heat test)
Screw cap fixing	M12 × 0.75
Approvals	UL 1283, 250 V

**Characteristics and ordering codes**

$I_R$ A	$C_R$ μF	$V_R$ V AC	$V_R$ V DC	$V_{test}$ V DC	Terminal	Figure	Ordering code	Approvals 
25	0.035	250	600	4000	M4	1	B85121A2353A250	×
	0.010	250	600	4000	Leads ∅ 2 mm	2	B85121A2103B250	×
	0.025	250	600	4000			B85121A2253B250	×
	0.035	250	600	4000			B85121A2353B250	×
	0.035	440	600	4350			B85121A4353B250	×
	0.05	250	600	4000			B85121A2503B250	×
	0.05	440	600	4000			B85121A4503B250	×
	1.0	75	160	480			B85121A0105B250	–

× = approval granted

**Insertion loss (dB); typical values at 50 Ω**

$C_R$ (μF)	10 kHz	100 kHz	1 MHz	10 MHz	100 MHz	> 300 MHz
0.025	–	–	11	30	55	> 80
0.035	–	1	12	32	55	> 90
0.050	–	2	18	35	60	> 90
1.0	5	25	45	50	85	> 90

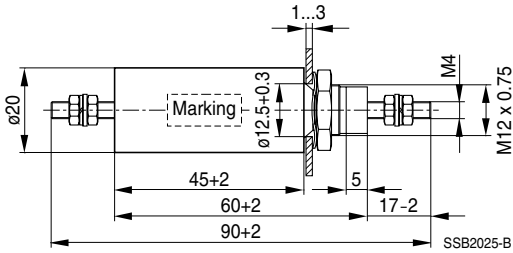

**Dimensional drawings**
**Figure 1, B85121A\*\*\*\*A250**

Thread	Tightening torque
M4	1.2 +0.1 Nm
M12 x 0.75	4.0 +0.5 Nm

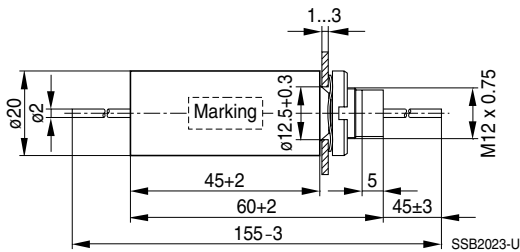
**Figure 2, B85121A\*\*\*\*B250**

Tightening torque: 4 +0.5 Nm

**Feedthrough capacitors ∅ 24 mm, housing with external screw thread**
**Technical data and measuring conditions**

Rated voltage $V_R$	250 V AC, 50/60 Hz 600 V DC
Rated current $I_R$	Referred to 40 °C ambient temperature Reduced current values at 400 Hz
Capacitance tolerance	±20%
Climatic category (IEC 60068-1)	40/085/56 (−40 °C/+85 °C/56 days damp heat test)
Screw cap fixing	M24 × 1.5
Approvals	UL 1283, 250 V

**Characteristics and ordering code**

$I_R$ A	$C_R$ μF	$V_R$ V AC	$V_R$ V DC	$V_{test}$ V DC	Terminal	Ordering code	Approvals 
50	0.05	250	600	3000	M6	B85111A2503B500	×

× = approval granted

**Insertion loss (dB); typical values at 50 Ω**

$C_R$ (μF)	10 kHz	100 kHz	1 MHz	10 MHz	100 MHz	> 300 MHz
0.05	–	2	18	35	60	> 90

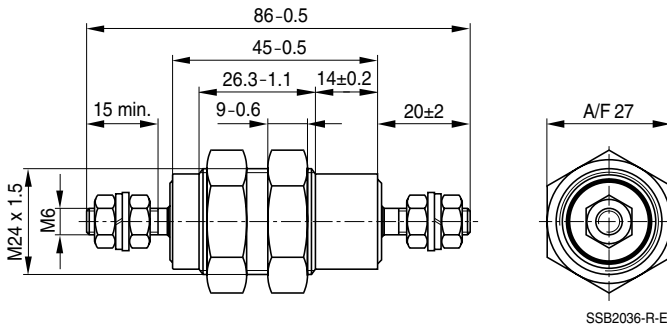
**Dimensional drawing**

Thread	Tightening torque
M6	3 +0.5 Nm
M24 × 1.5	12 +1.5 Nm

**Feedthrough capacitors ∅ 30 mm**
**Technical data and measuring conditions**

Rated voltage $V_R$	250 V AC, 50/60 Hz 600 V DC
Rated current $I_R$	Referred to 40 °C ambient temperature Reduced current values at 400 Hz
Capacitance tolerance	±20%
Climatic category (IEC 60068-1)	40/085/56 (−40 °C/+85 °C/56 days damp heat test)
Screw cap fixing	M20 × 1
Approvals	UL 1283, 250 V

**Characteristics and ordering codes**

$I_R$ A	$C_R$ μF	$V_R$ V AC	$V_R$ V DC	$V_{test}$ V DC	Terminal	Ordering code	Approvals 
25	0.1	250	600	3000	M6	B85121A2104A250	×
	0.5	250	600	2500	M6	B85121A2504A250	×
	1.0	250	600	2000	M6	B85121A2105A250	×
75	0.1	250	600	3000	M6	B85121A2104A750	×
	0.5	250	600	2500	M6	B85121A2504A750	×
	1.0	250	600	2000	M6	B85121A2105A750	×

× = approval granted

**Insertion loss (dB); typical values at 50 Ω**

$C_R$ (μF)	10 kHz	100 kHz	1 MHz	10 MHz	100 MHz	1 GHz
0.1	0	5	20	40	60	> 70
0.5	2	15	35	40	80	> 90
1.0	5	25	45	50	85	> 90

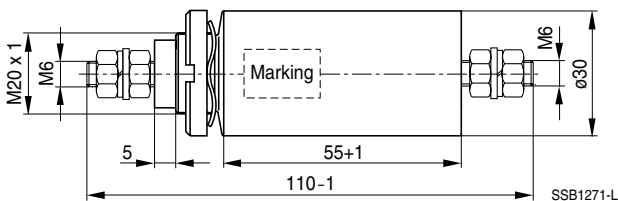
**Dimensional drawing**

Thread	Tightening torque
M6	3 + 0.5 Nm
M20 × 1	10 + 1 Nm

**Feedthrough capacitors Ø 55 mm**
**Technical data and measuring conditions**

Rated voltage $V_R$	250 V AC, 50/60 Hz 600 V DC
Rated current $I_R$	Referred to 40 °C ambient temperature Reduced current values at 400 Hz
Capacitance tolerance	±20%
Climatic category (IEC 60068-1)	40/085/56 (−40 °C/+85 °C/56 days damp heat test)
Screw cap fixing	Standard M32 × 1.5 Special fixing M27 × 1.5 on request
Approvals	UL 1283, 250 V

**Characteristics and ordering codes**

$I_R$ A	$C_R$ µF	$V_R$ V AC	$V_R$ V DC	$V_{test}$ V DC	Ter- minal	Dimensions (mm)			Ordering code	Approvals 
						$l_{+1}$	$l_{-1}$	$l_{2-3}$		
63	0.5	250	600	3000	M 6	30	100	50	B85121A2504A630	×
	1.0	250	600	2500	M 6	30	100	50	B85121A2105A630	×
	2.0	250	600	2500	M 6	60	130	50	B85121A2205A630	×
	4.7	250	600	2000	M 6	60	130	50	B85121A2475A630	×
100	0.5	250	600	3000	M 8	30	110	53	B85121A2504A101	×
	1.0	250	600	2500	M 8	30	110	53	B85121A2105A101	×
	2.0	250	600	2500	M 8	60	140	53	B85121A2205A101	×
	4.7	250	600	2000	M 8	60	140	53	B85121A2475A101	×
200	0.5	250	600	3000	M10	30	120	59	B85121A2504A201	×
	1.0	250	600	2500	M10	30	120	59	B85121A2105A201	×
	2.0	250	600	2500	M10	60	150	59	B85121A2205A201	×
	4.7	250	600	2000	M10	60	150	59	B85121A2475A201	×

× = approval granted

**Insertion loss (dB); typical values at 50 Ω**

$C_R$ (µF)	10 kHz	100 kHz	1 MHz	10 MHz	100 MHz	1 GHz
0.5	2	15	35	40	80	> 90
1.0	5	25	45	50	85	> 90
2.0	10	30	50	55	> 90	> 90
4.7	15	35	55	65	> 90	> 90

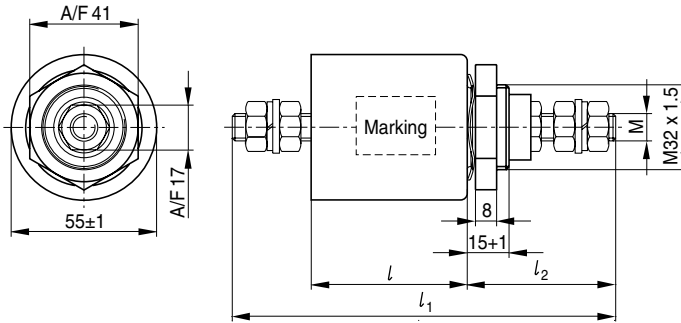
**Dimensional drawing**

SSB1272-U-E

Thread	Tightening torque
M6	3 +0.5 Nm
M8	5 +0.5 Nm
M10	8 +2 Nm
M27 × 1.5	16 +2 Nm
M32 × 1.5	24 +2.5 Nm

### Important information

Please read all safety and warning notes carefully before installing the EMC filter and putting it into operation (see ). The same applies to the warning signs on the filter. Please ensure that the signs are not removed nor their legibility impaired by external influences.

Death, serious bodily injury and substantial material damage to equipment may occur if the appropriate safety measures are not carried out or the warnings in the text are not observed.

### Using according to the terms

The EMC filters may be used only for their intended application within the specified values in low-voltage networks in compliance with the instructions given in the data sheets and the data book. The conditions at the place of application must comply with all specifications for the filter used.

### Warnings

- It shall be ensured that only qualified persons (electricity specialists) are engaged on work such as planning, assembly, installation, operation, repair and maintenance. They must be provided with the corresponding documentation.
- Danger of electric shock. EMC filters contain components that store an electric charge. Dangerous voltages can continue to exist at the filter terminals for longer than five minutes even after the power has been switched off.
- The protective earth connections shall be the first to be made when the EMC filter is installed and the last to be disconnected. Depending on the magnitude of the leakage currents, the particular specifications for making the protective-earth connection must be observed.
- Impermissible overloading of the EMC filter, such as impermissible voltages at higher frequencies that may cause resonances etc. can lead to destruction of the filter housing.
- EMC filters must be protected in the application against impermissible exceeding of the rated currents by suitable overcurrent protective.

The following applies to all products named in this publication:

1. Some parts of this publication contain **statements about the suitability of our products for certain areas of application**. These statements are based on our knowledge of typical requirements that are often placed on our products in the areas of application concerned. We nevertheless expressly point out **that such statements cannot be regarded as binding statements about the suitability of our products for a particular customer application**. As a rule, EPCOS is either unfamiliar with individual customer applications or less familiar with them than the customers themselves. For these reasons, it is always ultimately incumbent on the customer to check and decide whether an EPCOS product with the properties described in the product specification is suitable for use in a particular customer application.
2. We also point out that **in individual cases, a malfunction of passive electronic components or failure before the end of their usual service life cannot be completely ruled out in the current state of the art, even if they are operated as specified**. In customer applications requiring a very high level of operational safety and especially in customer applications in which the malfunction or failure of a passive electronic component could endanger human life or health (e.g. in accident prevention or life-saving systems), it must therefore be ensured by means of suitable design of the customer application or other action taken by the customer (e.g. installation of protective circuitry or redundancy) that no injury or damage is sustained by third parties in the event of malfunction or failure of a passive electronic component.
3. **The warnings, cautions and product-specific notes must be observed.**
4. In order to satisfy certain technical requirements, **some of the products described in this publication may contain substances subject to restrictions in certain jurisdictions (e.g. because they are classed as “hazardous”)**. Useful information on this will be found in our Material Data Sheets on the Internet ([www.epcos.com/material](http://www.epcos.com/material)). Should you have any more detailed questions, please contact our sales offices.
5. We constantly strive to improve our products. Consequently, **the products described in this publication may change from time to time**. The same is true of the corresponding product specifications. Please check therefore to what extent product descriptions and specifications contained in this publication are still applicable before or when you place an order.  
We also **reserve the right to discontinue production and delivery of products**. Consequently, we cannot guarantee that all products named in this publication will always be available.
6. Unless otherwise agreed in individual contracts, **all orders are subject to the current version of the “General Terms of Delivery for Products and Services in the Electrical Industry” published by the German Electrical and Electronics Industry Association (ZVEI)**.
7. The trade names EPCOS, EPCOS-Jones, Baoke, CeraDiode, CSSP, MLSC, PhaseCap, PhaseMod, SIFI, SIKOREL, SilverCap, SIMID, SIOV, SIP5D, SIP5K, UltraCap, WindCap are **trademarks registered or pending** in Europe and in other countries. Further information will be found on the Internet at [www.epcos.com/trademarks](http://www.epcos.com/trademarks).

Компания «Life Electronics» занимается поставками электронных компонентов импортного и отечественного производства от производителей и со складов крупных дистрибьюторов Европы, Америки и Азии.

С конца 2013 года компания активно расширяет линейку поставок компонентов по направлению коаксиальный кабель, кварцевые генераторы и конденсаторы (керамические, пленочные, электролитические), за счёт заключения дистрибьюторских договоров

Мы предлагаем:

- Конкурентоспособные цены и скидки постоянным клиентам.
- Специальные условия для постоянных клиентов.
- Подбор аналогов.
- Поставку компонентов в любых объемах, удовлетворяющих вашим потребностям.
- Приемлемые сроки поставки, возможна ускоренная поставка.
- Доставку товара в любую точку России и стран СНГ.
- Комплексную поставку.
- Работу по проектам и поставку образцов.
- Формирование склада под заказчика.
- Сертификаты соответствия на поставляемую продукцию (по желанию клиента).
- Тестирование поставляемой продукции.
- Поставку компонентов, требующих военную и космическую приемку.
- Входной контроль качества.
- Наличие сертификата ISO.

В составе нашей компании организован Конструкторский отдел, призванный помогать разработчикам, и инженерам.

Конструкторский отдел помогает осуществить:

- Регистрацию проекта у производителя компонентов.
- Техническую поддержку проекта.
- Защиту от снятия компонента с производства.
- Оценку стоимости проекта по компонентам.
- Изготовление тестовой платы монтаж и пусконаладочные работы.



Тел: +7 (812) 336 43 04 (многоканальный)

Email: [org@lifeelectronics.ru](mailto:org@lifeelectronics.ru)